

### FEATURES

- Output fanout buffer for DC to 134MHz
- Output Options:
  - 1:5 output fanout with *PL123-05*
  - 1:9 output fanout with *PL123-09*
- Low power consumption for portable applications
- Low input-output delay
- Output-Output skew less than 250ps
- Low Additive Phase Jitter of 60fs RMS
- 2.5V to 3.3V,  $\pm 10\%$  operation
- 1.8V  $\pm 10\%$  operation up to 67MHz
- Operating temperature range from  $-40^{\circ}\text{C}$  to  $85^{\circ}\text{C}$
- Available in 16-Pin SOP (PL123-09) and 8-Pin SOP (PL123-05). Both are GREEN/RoHS packages.

### DESCRIPTION

The PL123-05N and PL123-09N are a low-cost fanout buffers for distributing high-speed clocks with low output to output skew and preserving low noise properties. The fanout buffers accept an input from DC to 134MHz and provide 5 or 9 outputs of the same frequency. A typical PL123-09N application for driving SDRAM in PC systems would use eight outputs to drive two DIMMs, or four SO-DIMMs, with the remaining output used for driving an external feedback to a PLL. A typical PL123-05N application is to fanout a low noise CMOS clock oscillator to 5 low noise CMOS clocks.

These parts are not intended for 5V input-tolerant applications.

### BLOCK DIAGRAM AND PACKAGE PINOUT

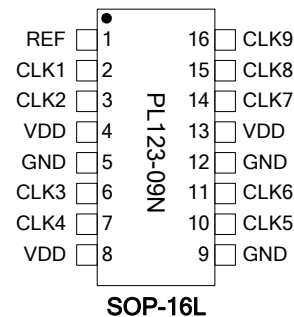
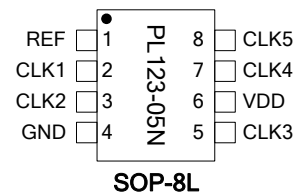
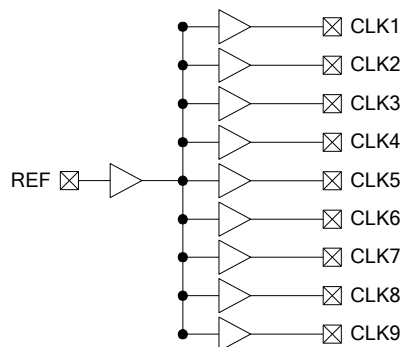
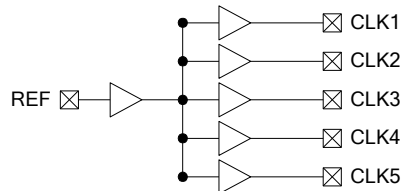

### PIN DESCRIPTIONS

Name	PL123-09N SOP-16L	PL123-05N SOP-8L	Type	Description
REF	1	1	I	Input reference frequency.
CLK1	2	2	O	Buffered clock output
CLK2	3	3	O	Buffered clock output
VDD	4, 8, 13	6	P	VDD connection
GND	5, 9, 12	4	P	GND connection
CLK3	6	5	O	Buffered clock output
CLK4	7	7	O	Buffered clock output
CLK5	10	8	O	Buffered clock output
CLK6	11	-	O	Buffered clock output
CLK7	14	-	O	Buffered clock output
CLK8	15	-	O	Buffered clock output
CLK9	16	-	O	Buffered clock output

### LAYOUT RECOMMENDATIONS

The following guidelines are to assist you with a performance optimized PCB design:

#### Signal Integrity and Termination Considerations

- Keep traces short!
- Trace = Inductor. With a capacitive load this equals ringing!
- Long trace = Transmission Line. Without proper termination this will cause reflections ( looks like ringing ).
- Design long traces (> 1 inch) as "striplines" or "microstrips" with defined impedance.
- Match trace at one side to avoid reflections bouncing back and forth.

#### Decoupling and Power Supply Considerations

- Place decoupling capacitors as close as possible to the VDD pin(s) to limit noise from the power supply
- Addition of a ferrite bead in series with VDD can help prevent noise from other board sources
- Value of decoupling capacitor is frequency dependant. Typical values to use are 0.1 $\mu$ F for designs using frequencies < 50MHz and 0.01 $\mu$ F for designs using frequencies > 50MHz.

#### Typical CMOS termination

Place Series Resistor as close as possible to CMOS output

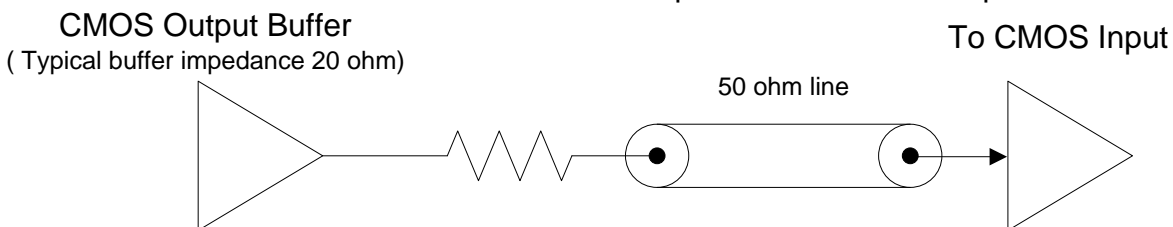

Connect a 33 ohm series resistor at each of the output clocks to enhance the stability of the output signal



# PL123-05N/-09N

## Low Skew Fanout Buffer

### ABSOLUTE MAXIMUM CONDITIONS

Supply Voltage to Ground Potential ..... -0.5V to 4.6V  
 DC Input Voltage .....  $V_{SS} - 0.5V$  to 4.6V  
 Storage Temperature ..... -65°C to 150°C

Junction Temperature..... 150°C  
 Static Discharge Voltage  
 (per MIL-STD-883, Method 3015)..... > 2000V

### OPERATING CONDITIONS

Parameter	Description	Min.	Max.	Unit
$V_{DD}$	Supply Voltage	1.62	3.63	V
$T_A$	Commercial Operating Temperature (ambient temperature)	0	70	°C
	Industrial Operating Temperature (ambient temperature)	-40	85	°C
$C_L$	Load Capacitance, below 100 MHz, $V_{DD} > 2.25V$	—	30	pF
	Load Capacitance, above 100 MHz, $V_{DD} > 2.25V$	—	10	pF
	Load Capacitance, below 67MHz, $1.62V < V_{DD} < 2.25V$	—	15	pF
$C_{IN}$	Input Capacitance	—	7	pF
REF, CLK[1:9]	Operating Frequency, Input=Output, $V_{DD} > 2.25V$	DC	134	MHz
	Operating Frequency, Input=Output, $1.62V < V_{DD} < 2.25V$	DC	67	MHz
$t_{PU}$	Power-up time for all $V_{DD}$ s to reach minimum specified voltage (power ramps must be monotonic)	0.05	50	ms

### ELECTRICAL CHARACTERISTICS (Commercial and Industrial Temperature Devices)

Parameter	Description	Test Conditions	Min.	Max.	Unit
V <sub>IL</sub>	Input LOW Voltage <sup>[1]</sup>	V <sub>DD</sub> > 2.25V	–	0.8	V
V <sub>IH</sub>	Input HIGH Voltage <sup>[1]</sup>	V <sub>DD</sub> > 2.25V	2.0	–	V
I <sub>IL</sub>	Input LOW Current	V <sub>IN</sub> = 0V	–	50	μA
I <sub>IH</sub>	Input HIGH Current	V <sub>IN</sub> = V <sub>DD</sub>	–	100	μA
V <sub>OL</sub>	Output LOW Voltage <sup>[2]</sup>	I <sub>OL</sub> = 8 mA , V <sub>DD</sub> > 2.97V	–	0.4	V
V <sub>OH</sub>	Output HIGH Voltage <sup>[2]</sup>	I <sub>OH</sub> = –8 mA , V <sub>DD</sub> > 2.97V	2.4	–	V
I <sub>DD</sub>	Supply Current	66.67MHz with unloaded outputs	–	32	mA

### SWITCHING CHARACTERISTICS (Commercial and Industrial Temperature Devices) <sup>[3]</sup>

Parameter	Description	Test Conditions	Min.	Typ.	Max.	Unit
	Duty Cycle <sup>[2]</sup> = t <sub>2</sub> ÷ t <sub>1</sub>	Measured at 1.4V, V <sub>DD</sub> =3.3V, Input=50%	40	50	60	%
		Measured at V <sub>DD</sub> /2, Input = 50%	40	50	60	%
t <sub>3</sub>	Rise Time <sup>[2]</sup>	0.8V → 2.0V, V <sub>DD</sub> =3.3V, 30pF Load	–	–	1.5	ns
		10% → 90%, V <sub>DD</sub> =2.5V, 15pF Load	–	–	2.5	ns
		10% → 90%, V <sub>DD</sub> =1.8V, 15pF Load	–	–	4.5	ns
t <sub>4</sub>	Fall Time <sup>[2]</sup>	2.0V → 0.8V, V <sub>DD</sub> =3.3V, 30pF Load	–	–	1.5	ns
		90% → 10%, V <sub>DD</sub> =2.5V, 15pF Load	–	–	2.5	ns
		90% → 10%, V <sub>DD</sub> =1.8V, 15pF Load	–	–	4.5	ns
t <sub>5</sub>	Output to Output Skew <sup>[2]</sup>	All outputs equally loaded	–	–	250	ps
t <sub>6</sub>	Propagation Delay, REF Rising Edge to CLKX Rising Edge <sup>[2]</sup>	Measured at V <sub>DD</sub> /2	1	5	9.2	ns

#### Notes:

1. REF input has a threshold voltage of V<sub>DD</sub>/2
2. Parameter is guaranteed by design and characterization. Not 100% tested in production.
3. All parameters are specified with loaded outputs.

### NOISE CHARACTERISTICS (Commercial and Industrial Temperature Devices)

Parameter	Description	Test Conditions	Min.	Typ.	Max.	Unit
	Additive Phase Jitter	V <sub>DD</sub> =3.3V, Frequency=100MHz Offset=12KHz ~ 20MHz		60		fs

**PL123-09N Additive Phase Jitter:**  
**V<sub>DD</sub>=3.3V, CLK=100MHz, Integration Range 12KHz to 20MHz: 0.059ps typical.**

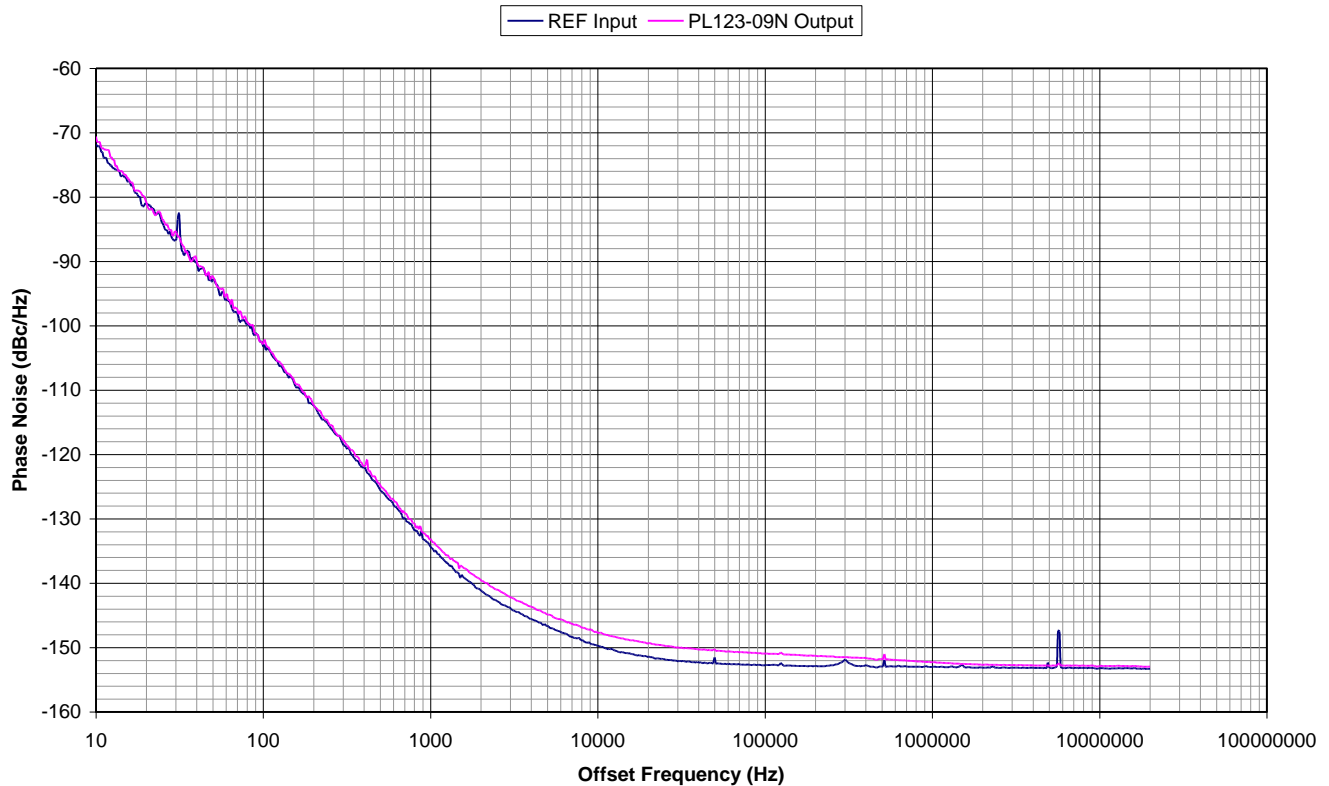

When a buffer is used to pass a signal then the buffer will add a little bit of its own noise. The phase noise on the output of the buffer will be a little bit more than the phase noise in the input signal. To quantify the noise addition in the buffer we compare the Phase Jitter numbers from the input and the output. The difference is called "Additive Phase Jitter". The formula for the Additive Phase Jitter is as follows:

$$\text{Additive Phase Jitter} = \sqrt{(\text{Output Phase Jitter})^2 - (\text{Input Phase Jitter})^2}$$

### SWITCHING WAVEFORMS

#### Duty Cycle Timing

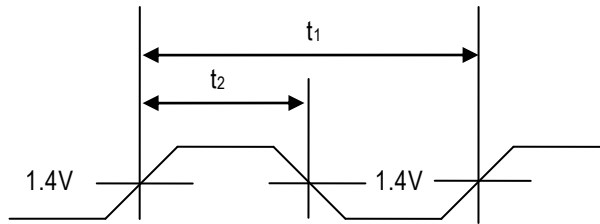

#### All Outputs Rise/Fall Time

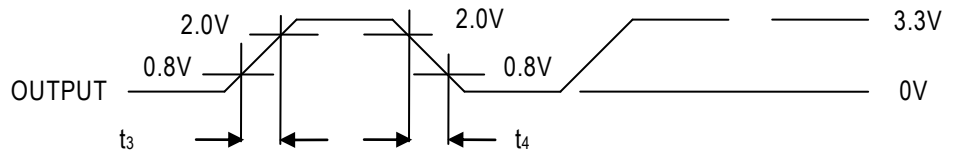

#### Output-Output Skew

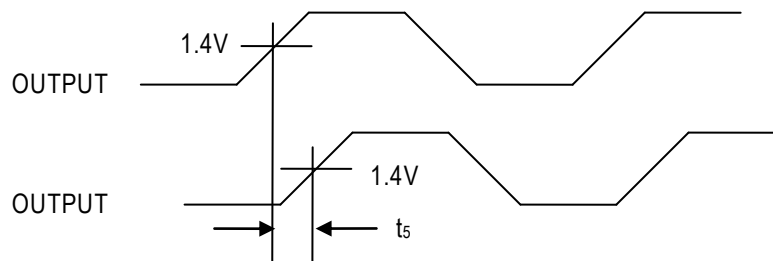

#### Input-Output Propagation Delay

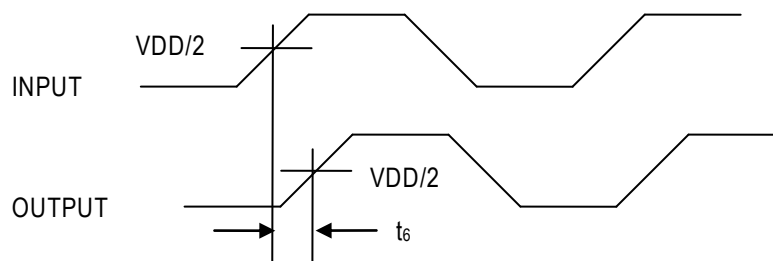

### TEST CIRCUIT

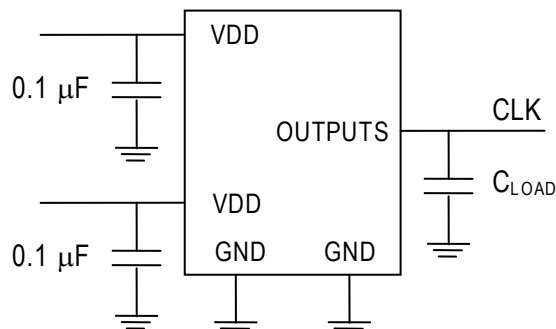

### PACKAGE DRAWING (GREEN PACKAGE COMPLIANT)

#### SOP-16L (mm)

Symbol	Min.	Max.
A	1.35	1.75
A1	0.10	0.25
B	0.33	0.51
C	0.19	0.25
D	9.80	10.00
E	3.80	4.00
H	5.80	6.20
L	0.40	1.27
e	1.27 BSC	

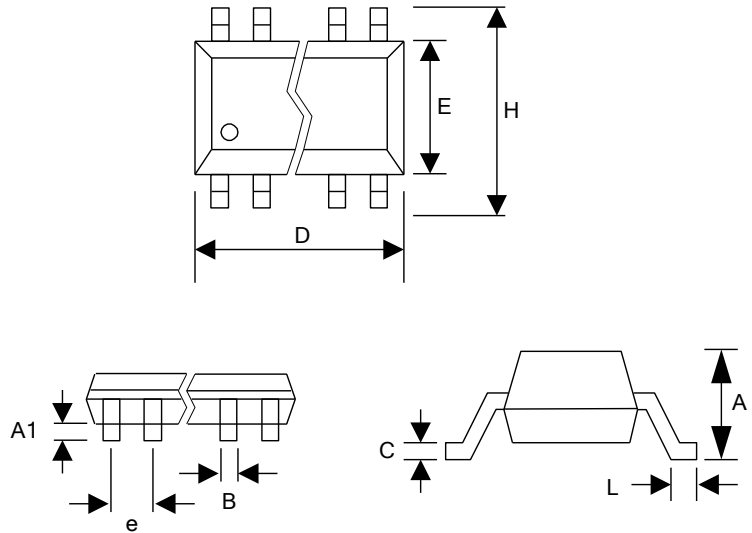

#### SOP-8L (mm)

Symbol	Min.	Max.
A	1.35	1.75
A1	0.10	0.25
A2	1.25	1.50
B	0.33	0.53
C	0.19	0.27
D	4.80	5.00
E	3.80	4.00
H	5.80	6.20
L	0.40	0.89
e	1.27 BSC	

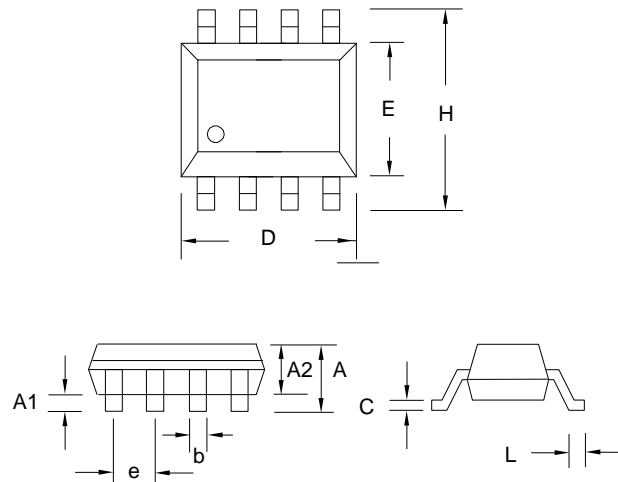

### ORDERING INFORMATION

**For part ordering, please contact our Sales Department:**

2180 Fortune Drive, San Jose, CA 95131, USA

Tel: (408) 944-0800 Fax: (408) 474-1000

#### PART NUMBER

The order number for this device is a combination of the following:

Part number, Package type and Operating temperature range

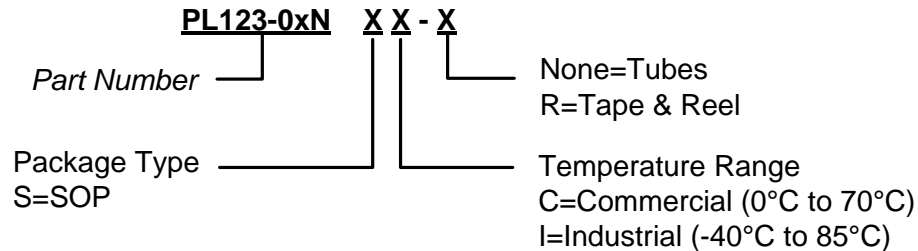

Part/Order Number	Marking	Package Option
Green (Lead-Free) Package		
PL123-09NSC	P12309N SC	16-Pin SOP Tube
PL123-09NSC-R	LLLLL	16-Pin SOP (Tape and Reel)
PL123-09NSI	P12309N SI	16-Pin SOP Tube
PL123-09NSI-R	LLLLL	16-Pin SOP (Tape and Reel)
PL123-05NSC	P12305N SC	8-Pin SOP Tube
PL123-05NSC-R	LLLLL	8-Pin SOP (Tape and Reel)
PL123-05NSI	P12305N SI	8-Pin SOP Tube
PL123-05NSI-R	LLLLL	8-Pin SOP (Tape and Reel)

\*Note: LLLLL designates lot number

Micrel Inc., reserves the right to make changes in its products or specifications, or both at any time without notice. The information furnished by Micrel is believed to be accurate and reliable. However, Micrel makes no guarantee or warranty concerning the accuracy of said information and shall not be responsible for any loss or damage of whatever nature resulting from the use of, or reliance upon this product.

**LIFE SUPPORT POLICY:** Micrel's products are not authorized for use as critical components in life support devices or systems without the express written approval of the President of Micrel Inc.