

**OPA544**

## High-Voltage, High-Current OPERATIONAL AMPLIFIER

### FEATURES

- **HIGH OUTPUT CURRENT: 2A min**
- **WIDE POWER SUPPLY RANGE:**  
 $\pm 10$  to  $\pm 35V$
- **SLEW RATE: 8V/ $\mu s$**
- **INTERNAL CURRENT LIMIT**
- **THERMAL SHUTDOWN PROTECTION**
- **FET INPUT:  $I_B = 100pA$  max**
- **5-LEAD TO-220 PLASTIC PACKAGE**
- **5-LEAD SURFACE MOUNT PACKAGE**

### APPLICATIONS

- **MOTOR DRIVER**
- **PROGRAMMABLE POWER SUPPLY**
- **SERVO AMPLIFIER**
- **VALVES, ACTUATOR DRIVER**
- **MAGNETIC DEFLECTION COIL DRIVER**
- **AUDIO AMPLIFIER**

### DESCRIPTION

The OPA544 is a high-voltage/high-current operational amplifier suitable for driving a wide variety of high power loads. High performance FET op amp circuitry and high power output stage are combined on a single monolithic chip.

The OPA544 is protected by internal current limit and thermal shutdown circuits.

The OPA544 is available in industry-standard 5-lead TO-220 and 5-lead surface-mount power packages. Its copper tab allows easy mounting to a heat sink for excellent thermal performance. It is specified for operation over the extended industrial temperature range,  $-40^{\circ}C$  to  $+85^{\circ}C$ .

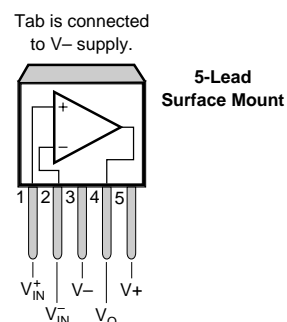
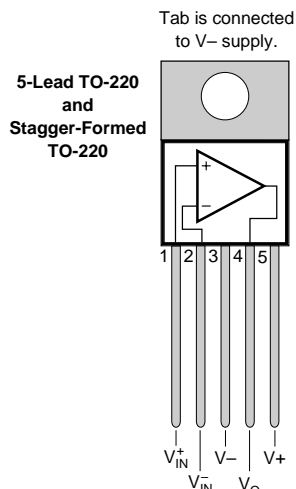

International Airport Industrial Park • Mailing Address: PO Box 11400, Tucson, AZ 85734 • Street Address: 6730 S. Tucson Blvd., Tucson, AZ 85706 • Tel: (520) 746-1111 • Twx: 910-952-1111  
Internet: <http://www.burr-brown.com/> • FAXLine: (800) 548-6133 (US/Canada Only) • Cable: BBRCORP • Telex: 066-6491 • FAX: (520) 889-1510 • Immediate Product Info: (800) 548-6132

# SPECIFICATIONS

At  $T_{CASE} = +25^{\circ}C$ ,  $V_S = \pm 35V$ , unless otherwise noted.

PARAMETER	CONDITION	OPA544T OPA544T-1 OPA544F			UNITS
		MIN	TYP	MAX	
<b>OFFSET VOLTAGE</b> Input Offset Voltage vs Temperature vs Power Supply	Specified Temperature Range $V_S = \pm 10V$ to $\pm 35V$		$\pm 1$ $\pm 10$ $\pm 10$	$\pm 5$  $\pm 100$	mV $\mu V/^{\circ}C$ $\mu V/V$
<b>INPUT BIAS CURRENT</b> <sup>(1)</sup> Input Bias Current vs Temperature Input Offset Current	$V_{CM} = 0V$  $V_{CM} = 0V$		$\pm 15$ See Typical Curve $\pm 10$	$\pm 100$  $\pm 100$	pA  pA
<b>NOISE</b> Input Voltage Noise Noise Density, $f = 1kHz$ Current Noise Density, $f = 1kHz$			36 3		$nV/\sqrt{Hz}$ $fA/\sqrt{Hz}$
<b>INPUT VOLTAGE RANGE</b> Common-Mode Input Range, Positive Negative Common-Mode Rejection	Linear Operation Linear Operation $V_{CM} = \pm V_S - 6V$	(V+) -6 (V-) +6 90	(V+) -4 (V-) +4 106		V V dB
<b>INPUT IMPEDANCE</b> Differential Common-Mode			$10^{12} \parallel 8$ $10^{12} \parallel 10$		$\Omega \parallel pF$ $\Omega \parallel pF$
<b>OPEN-LOOP GAIN</b> Open-Loop Voltage Gain	$V_O = \pm 30V$ , $R_L = 1k\Omega$	90	103		dB
<b>FREQUENCY RESPONSE</b> Gain Bandwidth Product Slew Rate Full-Power Bandwidth Settling Time 0.1% Total Harmonic Distortion	$R_L = 15\Omega$ $60Vp-p$ , $R_L = 15\Omega$  $G = -10$ , 60V Step	5	1.4 8 See Typical Curve 25 See Typical Curve		MHz V/ $\mu s$  $\mu s$
<b>OUTPUT</b> Voltage Output, Positive Negative Positive Negative Current Output Short-Circuit Current	$I_O = 2A$ $I_O = 2A$ $I_O = 0.5A$ $I_O = 0.5A$	(V+) -5 (V-) +5 (V+) -4.2 (V-) +4	(V+) -4.4 (V-) +3.8 (V+) -3.8 (V-) +3.1 See SOA Curves 4		V V V V A
<b>POWER SUPPLY</b> Specified Operating Voltage Operating Voltage Range Quiescent Current	  $I_O = 0$	$\pm 10$	$\pm 35$  $\pm 12$	$\pm 35$  $\pm 15$	V V mA
<b>TEMPERATURE RANGE</b> Operating Storage Thermal Resistance, $\theta_{JC}$ Thermal Resistance, $\theta_{JC}$ Thermal Resistance, $\theta_{JA}$	  $f > 50Hz$ DC No Heat Sink	-40 -40	2.7 3 65	+85 +125	$^{\circ}C$ $^{\circ}C$ $^{\circ}C/W$ $^{\circ}C/W$ $^{\circ}C/W$

NOTES: (1) High-speed test at  $T_J = 25^{\circ}C$ .

The information provided herein is believed to be reliable; however, BURR-BROWN assumes no responsibility for inaccuracies or omissions. BURR-BROWN assumes no responsibility for the use of this information, and all use of such information shall be entirely at the user's own risk. Prices and specifications are subject to change without notice. No patent rights or licenses to any of the circuits described herein are implied or granted to any third party. BURR-BROWN does not authorize or warrant any BURR-BROWN product for use in life support devices and/or systems.

## CONNECTION DIAGRAMS

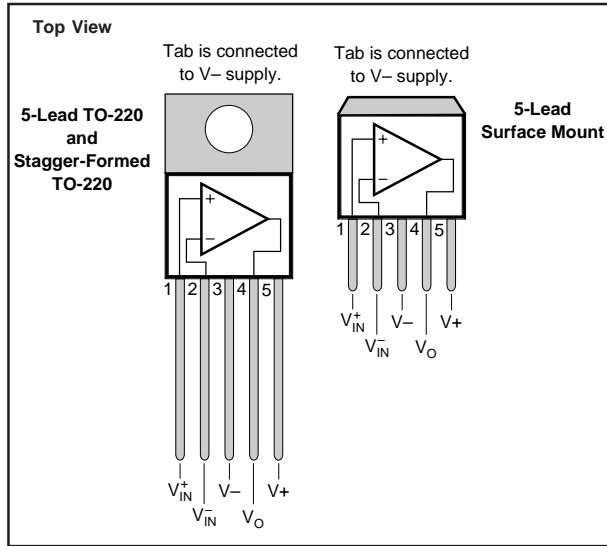

## ABSOLUTE MAXIMUM RATINGS

Supply Voltage, $V_+$ to $V_-$ .....	70V
Output Current .....	See SOA Curve
Input Voltage .....	( $V_-$ ) -0.7V to ( $V_+$ ) +0.7V
Operating Temperature .....	-40°C to +125°C
Storage Temperature .....	-40°C to +125°C
Junction Temperature .....	150°C
Lead Temperature (soldering -10s) <sup>(1)</sup> .....	300°C

NOTE: (1) Vapor-phase or IR reflow techniques are recommended for soldering the OPA544F surface mount package. Wave soldering is not recommended due to excessive thermal shock and "shadowing" of nearby devices.

## PACKAGE/ORDERING INFORMATION

PRODUCT	PACKAGE	PACKAGE DRAWING NUMBER <sup>(1)</sup>
OPA544T	5-Lead TO-220	315
OPA544T-1	5-Lead Stagger-Formed TO-220	323
OPA544F	5-Lead Surface-Mount	325

NOTE: (1) For detailed drawing and dimension table, please see end of data sheet, or Appendix C of Burr-Brown IC Data Book.

## ELECTROSTATIC DISCHARGE SENSITIVITY

This integrated circuit can be damaged by ESD. Burr-Brown recommends that all integrated circuits be handled with appropriate precautions. Failure to observe proper handling and installation procedures can cause damage.

ESD damage can range from subtle performance degradation to complete device failure. Precision integrated circuits may be more susceptible to damage because very small parametric changes could cause the device not to meet its published specifications.

# TYPICAL PERFORMANCE CURVES

At  $T_{CASE} = +25^{\circ}C$ ,  $V_S = \pm 35V$ , unless otherwise noted.

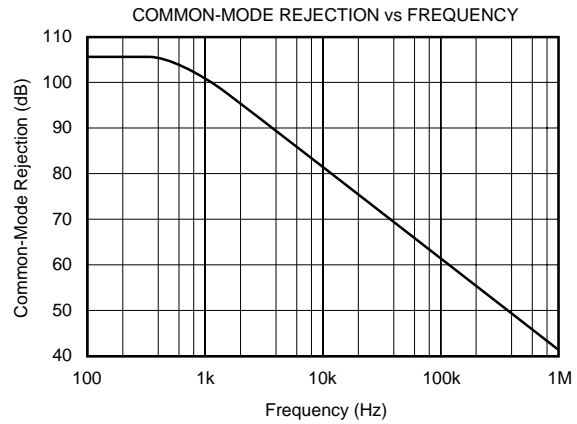
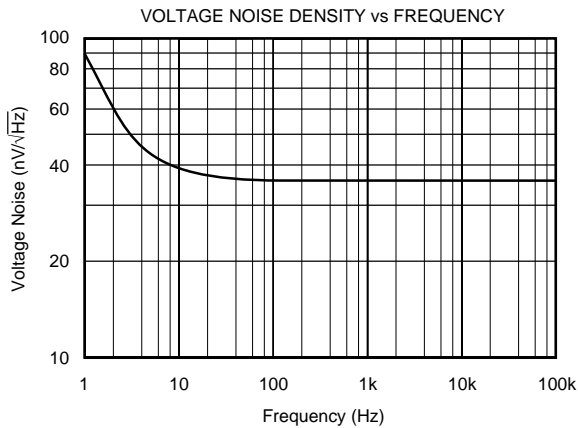
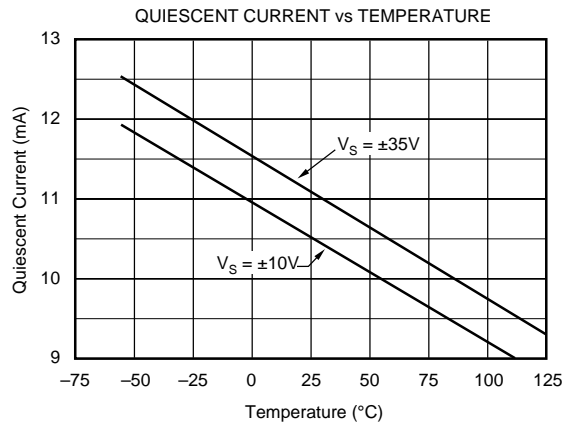
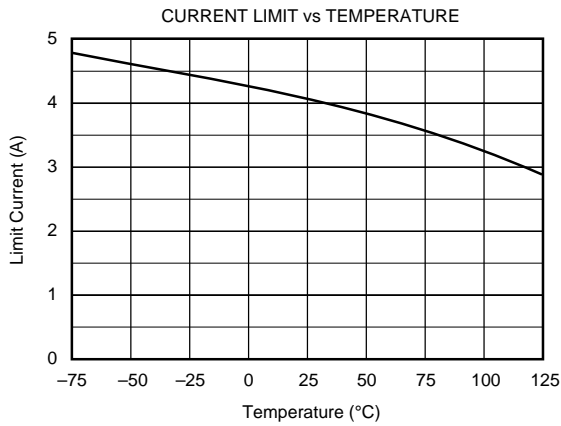
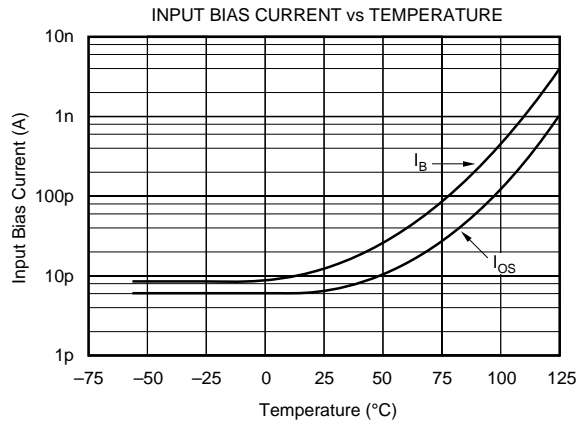
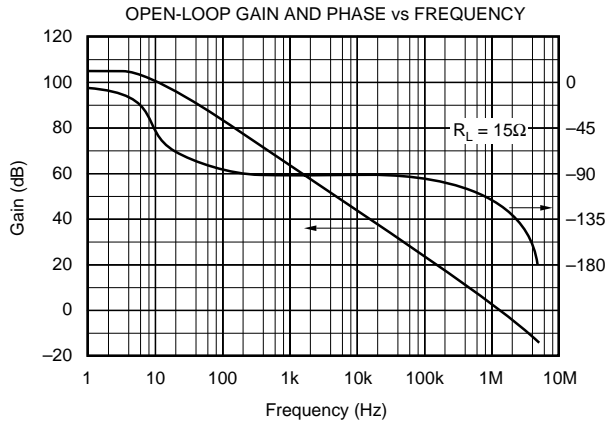

# TYPICAL PERFORMANCE CURVES (CONT)

At  $T_{CASE} = +25^{\circ}C$ ,  $V_S = \pm 35V$ , unless otherwise noted.

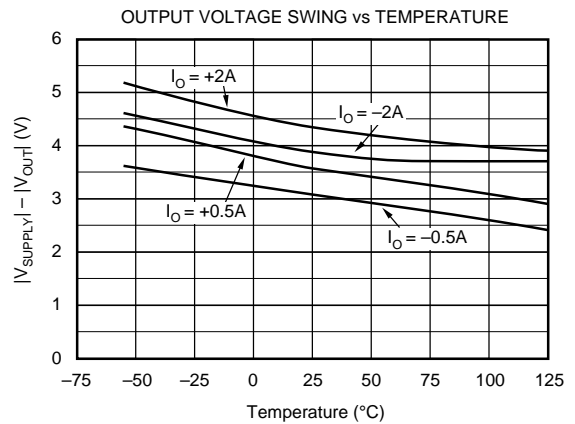
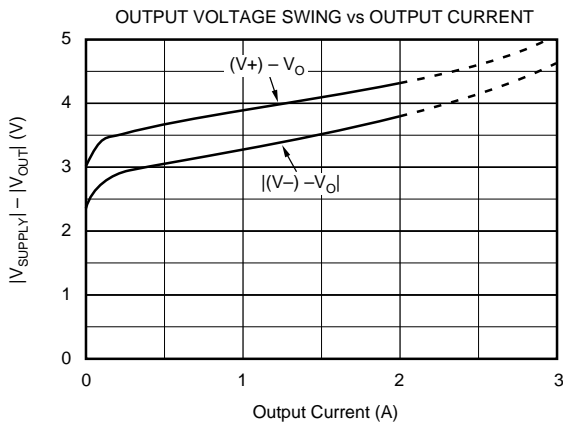
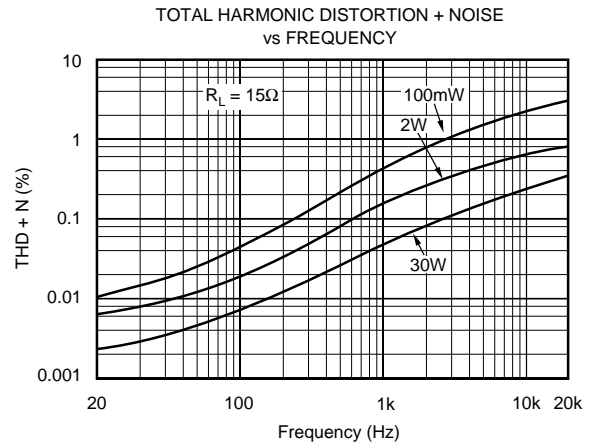
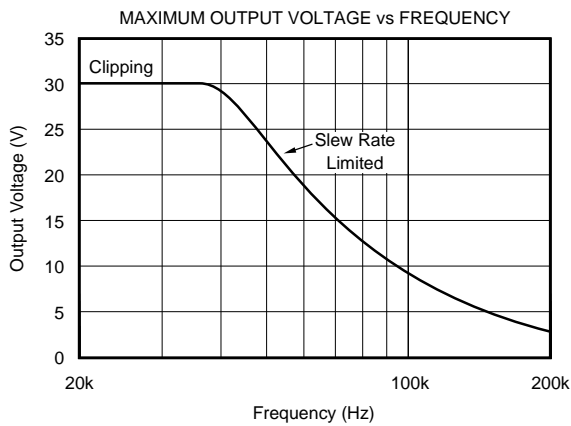
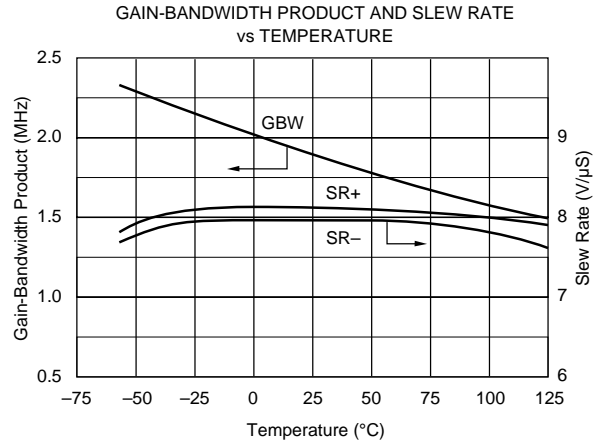
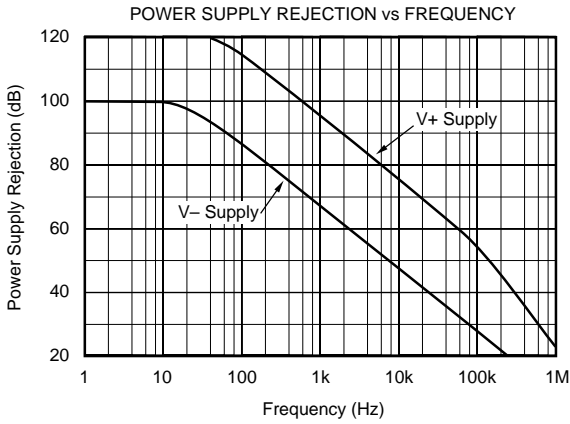

# TYPICAL PERFORMANCE CURVES (CONT)

At  $T_{CASE} = +25^{\circ}C$ ,  $V_S = \pm 35V$ , unless otherwise noted.

SMALL SIGNAL RESPONSE  
G = 3,  $C_L = 1nF$

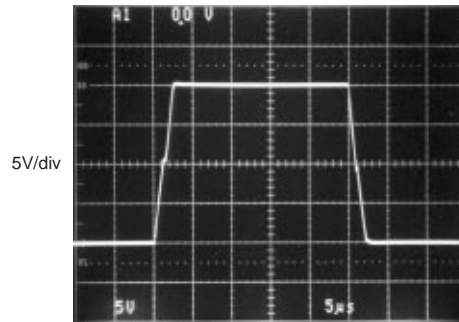
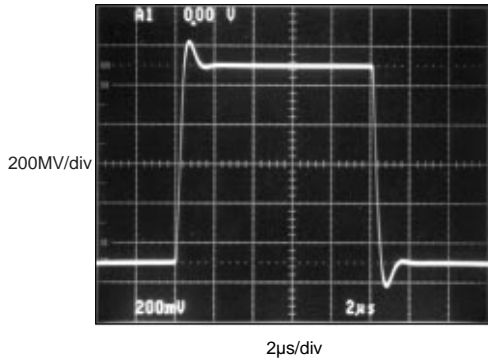

## APPLICATIONS INFORMATION

Figure 1 shows the OPA544 connected as a basic non-inverting amplifier. The OPA544 can be used in virtually any op amp configuration. Power supply terminals should be bypassed with low series impedance capacitors. The technique shown, using a ceramic and tantalum type in parallel is recommended. Power supply wiring should have low series impedance and inductance.

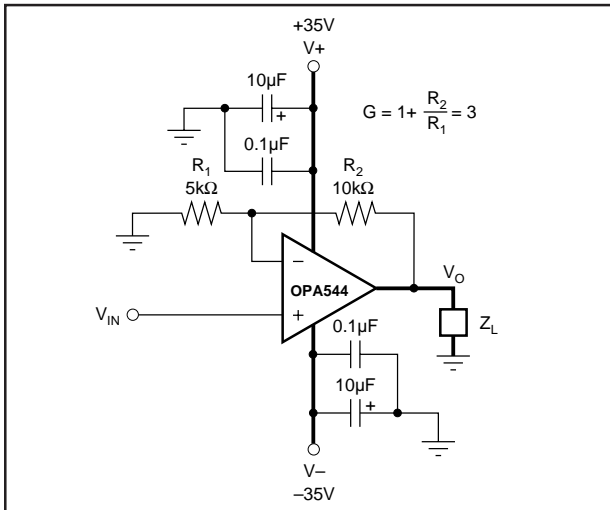

FIGURE 1. Basic Circuit Connections.

### SAFE OPERATING AREA

Stress on the output transistors is determined by the output current and the voltage across the conducting output transistor,  $V_S - V_O$ . The power dissipated by the output transistor is equal to the product of the output current and the voltage across the conducting transistor,  $V_S - V_O$ . The Safe Operating Area (SOA curve, Figure 2) shows the permissible range of voltage and current.

The safe output current decreases as  $V_S - V_O$  increases. Output short-circuits are a very demanding case for SOA. A short-circuit to ground forces the full power supply voltage ( $V+$  or  $V-$ ) across the conducting transistor. With  $V_S = \pm 35V$  the safe output current is 1.5A (at  $25^{\circ}C$ ). The short-circuit current is approximately 4A which exceeds the SOA. This situation will activate the thermal shutdown circuit in the OPA544. For further insight on SOA, consult Application Bulletin AB-039.

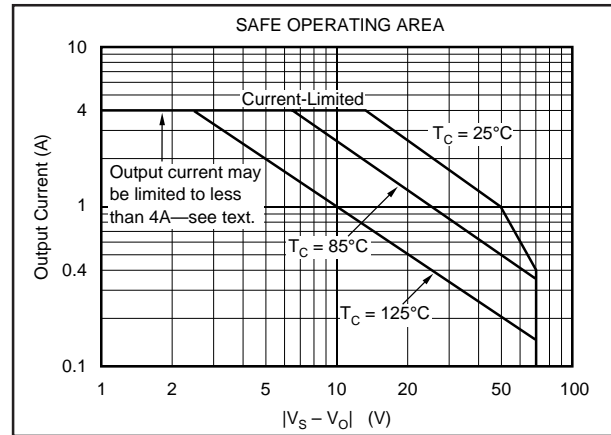

FIGURE 2. Safe Operating Area.

### CURRENT LIMIT

The OPA544 has an internal current limit set for approximately 4A. This current limit decreases with increasing junction temperature as shown in the typical curve, Current Limit vs Temperature. This, in combination with the thermal shutdown circuit, provides protection from many types of overload. It may not, however, protect for short-circuit to ground, depending on the power supply voltage, ambient temperature, heat sink and signal conditions.

## POWER DISSIPATION

Power dissipation depends on power supply, signal and load conditions. For dc signals, power dissipation is equal to the product of output current times the voltage across the conducting output transistor. Power dissipation can be minimized by using the lowest possible power supply voltage necessary to assure the required output voltage swing.

For resistive loads, the maximum power dissipation occurs at a dc output voltage of one-half the power supply voltage. Dissipation with ac signals is lower. Application Bulletin AB-039 explains how to calculate or measure power dissipation with unusual signals and loads.

## HEATSINKING

Most applications require a heat sink to assure that the maximum junction temperature is not exceeded. The heat sink required depends on the power dissipated and on ambient conditions. Consult Application Bulletin AB-038 for information on determining heat sink requirements.

The mounting tab of the surface-mount package version should be soldered to a circuit board copper area for good heat dissipation. Figure 3 shows typical thermal resistance from junction to ambient as a function of the copper area.

## THERMAL PROTECTION

The OPA544 has thermal shutdown that protects the amplifier from damage. Any tendency to activate the thermal shutdown circuit during normal operation is indication of excessive power dissipation or an inadequate heat sink.

The thermal protection activates at a junction temperature of approximately 155°C. For reliable operation, junction temperature should be limited to 150°C, maximum. To estimate the margin of safety in a complete design (including heat sink), increase the ambient temperature until the thermal protection is activated. Use worst-case load and signal conditions. For good reliability, the thermal protection should trigger more than 25°C above the maximum expected ambient condition of your application. This produces a junction temperature of 125°C at the maximum expected ambient condition.

Depending on load and signal conditions, the thermal protection circuit may produce a duty-cycle modulated output signal. This limits the dissipation in the amplifier, but the rapidly varying output waveform may be damaging to some loads. The thermal protection may behave differently depending on whether internal dissipation is produced by sourcing or sinking output current.

## OUTPUT STAGE COMPENSATION

The complex load impedances common in power op amp applications can cause output stage instability. Figure 3 shows an output series R/C compensation network (1Ω in series with 0.01μF) which generally provides excellent stability. Some variation in circuit values may be required with certain loads.

## UNBALANCED POWER SUPPLIES

Some applications do not require equal positive and negative output voltage swing. The power supply voltages of the OPA544 do not need to be equal. For example, a -6V negative power supply voltage assures that the inputs of the OPA544 are operated within their linear common-mode range, and that the output can swing to 0V. The V+ power supply could range from 15V to 65V. The total voltage (V- to V+) can range from 20V to 70V. With a 65V positive supply voltage, the device may not be protected from damage during short-circuits because of the larger  $V_{CE}$  during this condition.

## OUTPUT PROTECTION

Reactive and EMF-generating loads can return load current to the amplifier, causing the output voltage to exceed the power supply voltage. This damaging condition can be avoided with clamp diodes from the output terminal to the power supplies as shown in Figure 4. Fast-recovery rectifier diodes with a 4A or greater continuous rating are recommended.

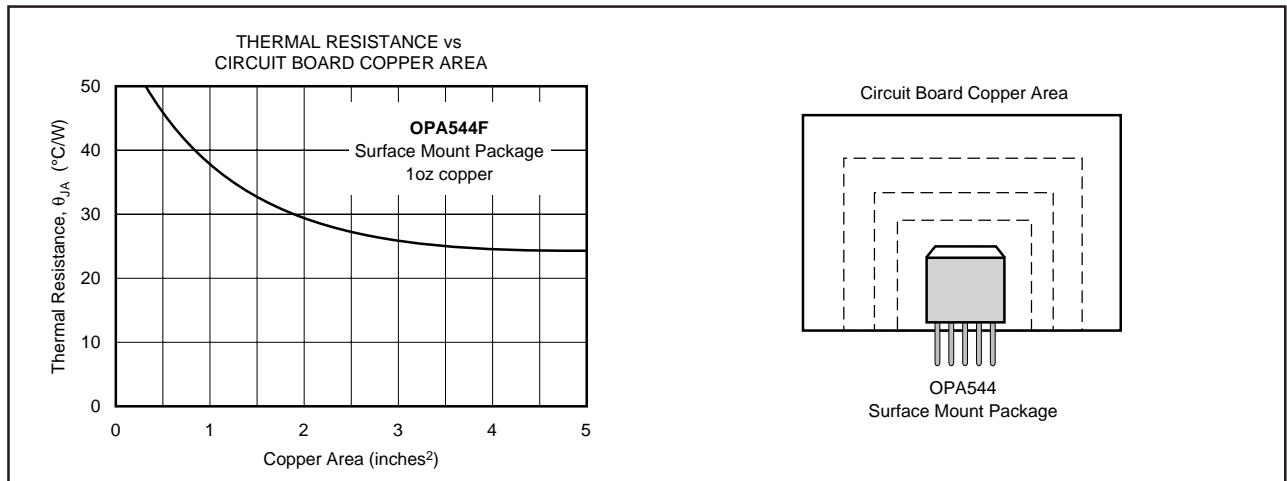

FIGURE 3. Thermal Resistance vs Circuit Board Copper Area.

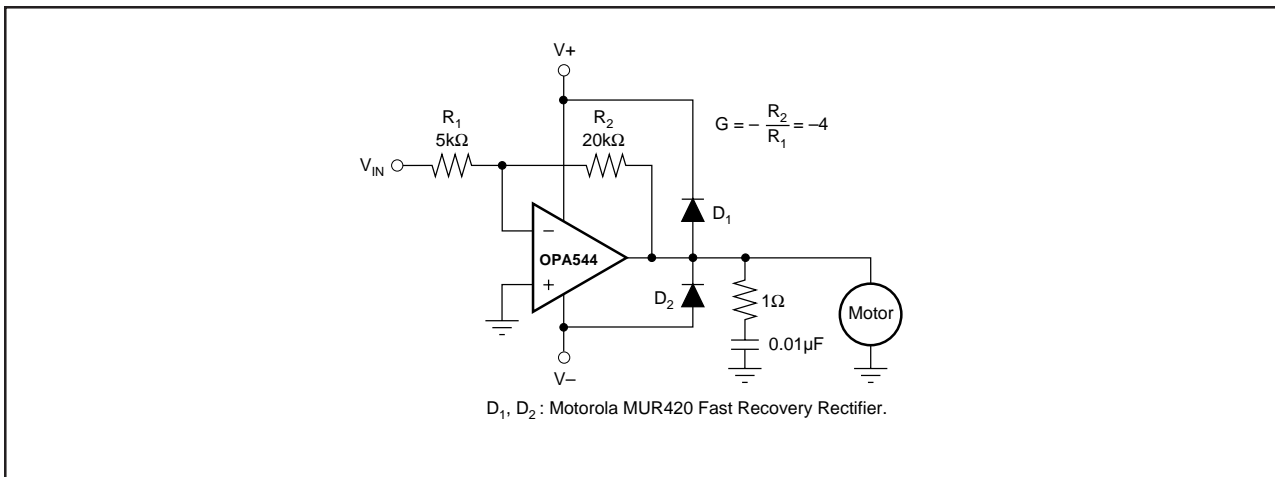

FIGURE 4. Motor Drive Circuit.

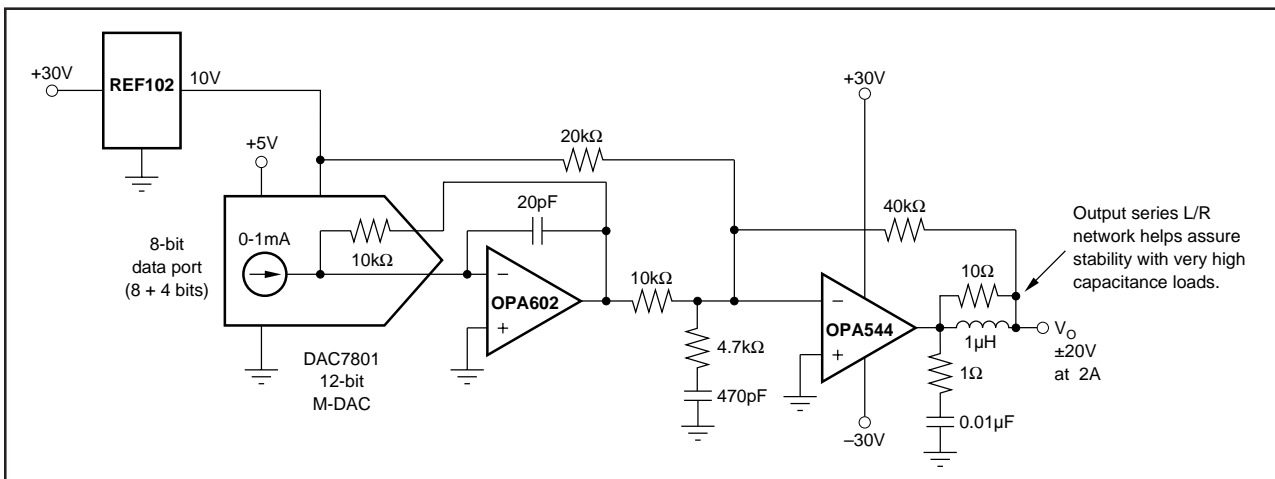

FIGURE 5. Digitally Programmable Power Supply.



**PACKAGING INFORMATION**

Orderable Device	Status (1)	Package Type	Package Drawing	Pins	Package Qty	Eco Plan (2)	Lead/Ball Finish	MSL Peak Temp (3)	Op Temp (°C)	Top-Side Markings (4)	Samples
OPA544F	OBSOLETE	DDPAK/ TO-263	KTT	5		TBD	Call TI	Call TI			
OPA544F/500	ACTIVE	DDPAK/ TO-263	KTT	5	500	Green (RoHS & no Sb/Br)	CU SN	Level-2-260C-1 YEAR		OPA544F	<a href="#">Samples</a>
OPA544F/500G3	ACTIVE	DDPAK/ TO-263	KTT	5	500	Green (RoHS & no Sb/Br)	CU SN	Level-2-260C-1 YEAR		OPA544F	<a href="#">Samples</a>
OPA544FKTTT	ACTIVE	DDPAK/ TO-263	KTT	5	50	TBD	Call TI	Call TI		OPA544F	<a href="#">Samples</a>
OPA544FKTTTG3	ACTIVE	DDPAK/ TO-263	KTT	5	50	TBD	Call TI	Call TI		OPA544F	<a href="#">Samples</a>
OPA544T	ACTIVE	TO-220	KC	5	49	TBD	Call TI	Call TI	-40 to 85	OPA544T	<a href="#">Samples</a>
OPA544T-1	OBSOLETE	TO-220	KC	5		TBD	Call TI	Call TI			
OPA544TG3	ACTIVE	TO-220	KC	5	49	TBD	Call TI	Call TI	-40 to 85	OPA544T	<a href="#">Samples</a>

(1) The marketing status values are defined as follows:

**ACTIVE:** Product device recommended for new designs.

**LIFEBUY:** TI has announced that the device will be discontinued, and a lifetime-buy period is in effect.

**NRND:** Not recommended for new designs. Device is in production to support existing customers, but TI does not recommend using this part in a new design.

**PREVIEW:** Device has been announced but is not in production. Samples may or may not be available.

**OBSOLETE:** TI has discontinued the production of the device.

(2) Eco Plan - The planned eco-friendly classification: Pb-Free (RoHS), Pb-Free (RoHS Exempt), or Green (RoHS & no Sb/Br) - please check <http://www.ti.com/productcontent> for the latest availability information and additional product content details.

**TBD:** The Pb-Free/Green conversion plan has not been defined.

**Pb-Free (RoHS):** TI's terms "Lead-Free" or "Pb-Free" mean semiconductor products that are compatible with the current RoHS requirements for all 6 substances, including the requirement that lead not exceed 0.1% by weight in homogeneous materials. Where designed to be soldered at high temperatures, TI Pb-Free products are suitable for use in specified lead-free processes.

**Pb-Free (RoHS Exempt):** This component has a RoHS exemption for either 1) lead-based flip-chip solder bumps used between the die and package, or 2) lead-based die adhesive used between the die and leadframe. The component is otherwise considered Pb-Free (RoHS compatible) as defined above.

**Green (RoHS & no Sb/Br):** TI defines "Green" to mean Pb-Free (RoHS compatible), and free of Bromine (Br) and Antimony (Sb) based flame retardants (Br or Sb do not exceed 0.1% by weight in homogeneous material)

(3) MSL, Peak Temp. -- The Moisture Sensitivity Level rating according to the JEDEC industry standard classifications, and peak solder temperature.

(4) Multiple Top-Side Markings will be inside parentheses. Only one Top-Side Marking contained in parentheses and separated by a "~" will appear on a device. If a line is indented then it is a continuation of the previous line and the two combined represent the entire Top-Side Marking for that device.

**Important Information and Disclaimer:** The information provided on this page represents TI's knowledge and belief as of the date that it is provided. TI bases its knowledge and belief on information provided by third parties, and makes no representation or warranty as to the accuracy of such information. Efforts are underway to better integrate information from third parties. TI has taken and continues to take reasonable steps to provide representative and accurate information but may not have conducted destructive testing or chemical analysis on incoming materials and chemicals. TI and TI suppliers consider certain information to be proprietary, and thus CAS numbers and other limited information may not be available for release.

In no event shall TI's liability arising out of such information exceed the total purchase price of the TI part(s) at issue in this document sold by TI to Customer on an annual basis.

## IMPORTANT NOTICE

Texas Instruments Incorporated and its subsidiaries (TI) reserve the right to make corrections, enhancements, improvements and other changes to its semiconductor products and services per JESD46, latest issue, and to discontinue any product or service per JESD48, latest issue. Buyers should obtain the latest relevant information before placing orders and should verify that such information is current and complete. All semiconductor products (also referred to herein as "components") are sold subject to TI's terms and conditions of sale supplied at the time of order acknowledgment.

TI warrants performance of its components to the specifications applicable at the time of sale, in accordance with the warranty in TI's terms and conditions of sale of semiconductor products. Testing and other quality control techniques are used to the extent TI deems necessary to support this warranty. Except where mandated by applicable law, testing of all parameters of each component is not necessarily performed.

TI assumes no liability for applications assistance or the design of Buyers' products. Buyers are responsible for their products and applications using TI components. To minimize the risks associated with Buyers' products and applications, Buyers should provide adequate design and operating safeguards.

TI does not warrant or represent that any license, either express or implied, is granted under any patent right, copyright, mask work right, or other intellectual property right relating to any combination, machine, or process in which TI components or services are used. Information published by TI regarding third-party products or services does not constitute a license to use such products or services or a warranty or endorsement thereof. Use of such information may require a license from a third party under the patents or other intellectual property of the third party, or a license from TI under the patents or other intellectual property of TI.

Reproduction of significant portions of TI information in TI data books or data sheets is permissible only if reproduction is without alteration and is accompanied by all associated warranties, conditions, limitations, and notices. TI is not responsible or liable for such altered documentation. Information of third parties may be subject to additional restrictions.

Resale of TI components or services with statements different from or beyond the parameters stated by TI for that component or service voids all express and any implied warranties for the associated TI component or service and is an unfair and deceptive business practice. TI is not responsible or liable for any such statements.

Buyer acknowledges and agrees that it is solely responsible for compliance with all legal, regulatory and safety-related requirements concerning its products, and any use of TI components in its applications, notwithstanding any applications-related information or support that may be provided by TI. Buyer represents and agrees that it has all the necessary expertise to create and implement safeguards which anticipate dangerous consequences of failures, monitor failures and their consequences, lessen the likelihood of failures that might cause harm and take appropriate remedial actions. Buyer will fully indemnify TI and its representatives against any damages arising out of the use of any TI components in safety-critical applications.

In some cases, TI components may be promoted specifically to facilitate safety-related applications. With such components, TI's goal is to help enable customers to design and create their own end-product solutions that meet applicable functional safety standards and requirements. Nonetheless, such components are subject to these terms.

No TI components are authorized for use in FDA Class III (or similar life-critical medical equipment) unless authorized officers of the parties have executed a special agreement specifically governing such use.

Only those TI components which TI has specifically designated as military grade or "enhanced plastic" are designed and intended for use in military/aerospace applications or environments. Buyer acknowledges and agrees that any military or aerospace use of TI components which have **not** been so designated is solely at the Buyer's risk, and that Buyer is solely responsible for compliance with all legal and regulatory requirements in connection with such use.

TI has specifically designated certain components as meeting ISO/TS16949 requirements, mainly for automotive use. In any case of use of non-designated products, TI will not be responsible for any failure to meet ISO/TS16949.

### Products

Audio	<a href="http://www.ti.com/audio">www.ti.com/audio</a>
Amplifiers	<a href="http://amplifier.ti.com">amplifier.ti.com</a>
Data Converters	<a href="http://dataconverter.ti.com">dataconverter.ti.com</a>
DLP® Products	<a href="http://www.dlp.com">www.dlp.com</a>
DSP	<a href="http://dsp.ti.com">dsp.ti.com</a>
Clocks and Timers	<a href="http://www.ti.com/clocks">www.ti.com/clocks</a>
Interface	<a href="http://interface.ti.com">interface.ti.com</a>
Logic	<a href="http://logic.ti.com">logic.ti.com</a>
Power Mgmt	<a href="http://power.ti.com">power.ti.com</a>
Microcontrollers	<a href="http://microcontroller.ti.com">microcontroller.ti.com</a>
RFID	<a href="http://www.ti-rfid.com">www.ti-rfid.com</a>
OMAP Applications Processors	<a href="http://www.ti.com/omap">www.ti.com/omap</a>
Wireless Connectivity	<a href="http://www.ti.com/wirelessconnectivity">www.ti.com/wirelessconnectivity</a>

### Applications

Automotive and Transportation	<a href="http://www.ti.com/automotive">www.ti.com/automotive</a>
Communications and Telecom	<a href="http://www.ti.com/communications">www.ti.com/communications</a>
Computers and Peripherals	<a href="http://www.ti.com/computers">www.ti.com/computers</a>
Consumer Electronics	<a href="http://www.ti.com/consumer-apps">www.ti.com/consumer-apps</a>
Energy and Lighting	<a href="http://www.ti.com/energy">www.ti.com/energy</a>
Industrial	<a href="http://www.ti.com/industrial">www.ti.com/industrial</a>
Medical	<a href="http://www.ti.com/medical">www.ti.com/medical</a>
Security	<a href="http://www.ti.com/security">www.ti.com/security</a>
Space, Avionics and Defense	<a href="http://www.ti.com/space-avionics-defense">www.ti.com/space-avionics-defense</a>
Video and Imaging	<a href="http://www.ti.com/video">www.ti.com/video</a>

### TI E2E Community

[e2e.ti.com](http://e2e.ti.com)