

# NX3P2902B

## Logic controlled high-side power switch

Rev. 2 — 22 February 2018

Product data sheet

### 1. General description

---

The NX3P2902B is a high-side load switch which features a low ON resistance P-channel MOSFET. The MOSFET supports more than 500 mA of continuous current and an integrated output discharge resistor to discharge the output capacitance when disabled. Designed for operation from 1.1 V to 3.6 V, it is used in power domain isolation applications to reduce power dissipation and extend battery life. The enable logic includes integrated logic level translation making the device compatible with lower voltage processors and controllers. The NX3P2902B is ideal for portable, battery operated applications due to low ground current and OFF-state current.

### 2. Features and benefits

---

- Wide supply voltage range from 1.1 V to 3.6 V
- Very low ON resistance:
  - ◆ 95 mΩ at a supply voltage of 1.8 V
- High noise immunity
- Low OFF-state leakage current (600 nA maximum)
- 1.2 V control logic at a supply voltage of 3.6 V
- High current handling capability (500 mA continuous current)
- Internal output discharge resistor
- Turn-on slew rate limiting
- ESD protection:
  - ◆ HBM JESD22-A114F Class 3A exceeds 4000 V
  - ◆ CDM AEC-Q100-011 revision B exceeds 500 V
- Specified from -40 °C to +85 °C

### 3. Applications

---

- Cell phone
- Digital cameras and audio devices
- Portable and battery-powered equipment



## 4. Ordering information

Table 1. Ordering information

Type number	Topside marking	Package		
		Name	Description	Version
NX3P2902BUK	x2	WLCSP4	wafer level chip-scale package; 4 bumps; 0.77 × 0.77 × 0.51 mm. (Backside coating included)	NX3P2902B

### 4.1 Ordering options

Table 2. Ordering options

Type number	Orderable part number	Package	Packing method	Minimum order quantity	Temperature
NX3P2902BUK	NX3P2902BUKZ	WLCSP4	Reel 7" Q1/T1 in Drypack	3000	T <sub>amb</sub> = -40 °C to +85 °C

## 5. Functional diagram

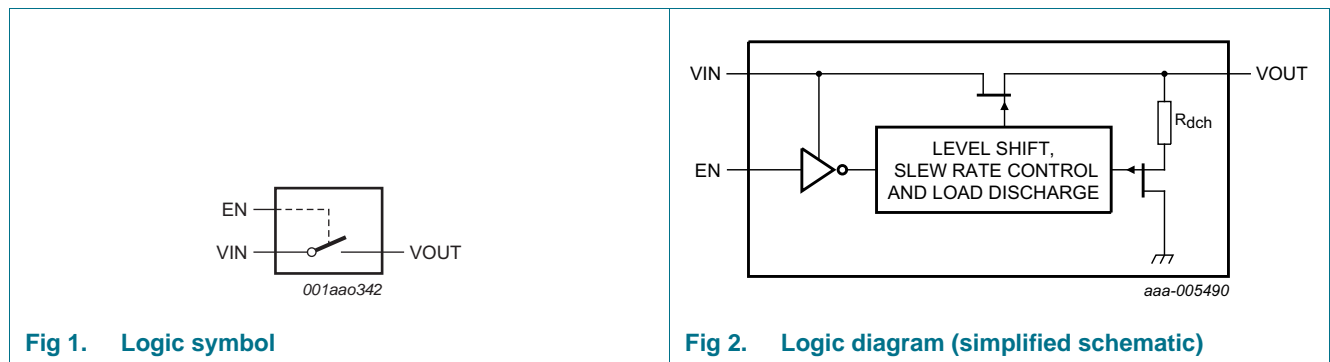

## 6. Pinning information

### 6.1 Pinning

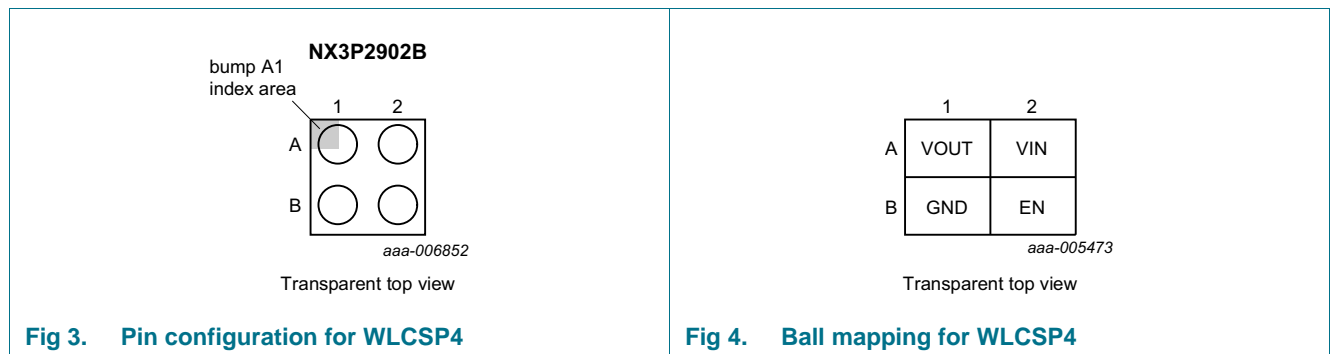

## 6.2 Pin description

Table 3. Pin description

Symbol	Pin	Description
VOUT	A1	output voltage
GND	B1	ground (0 V)
VIN	A2	input voltage
EN	B2	enable input (active HIGH)

## 7. Functional description

Table 4. Function table<sup>[1]</sup>

Input EN	Switch
L	switch OFF
H	switch ON

[1] H = HIGH voltage level; L = LOW voltage level.

## 8. Limiting values

Table 5. Limiting values

In accordance with the Absolute Maximum Rating System (IEC 60134). Voltages are referenced to GND (ground = 0 V).

Symbol	Parameter	Conditions	Min	Max	Unit
V <sub>I</sub>	input voltage	input EN <sup>[1]</sup>	-0.5	+4.0	V
		input VIN <sup>[2]</sup>	-0.5	+4.0	V
V <sub>SW</sub>	switch voltage	output VOUT <sup>[2]</sup>	-0.5	V <sub>I(VIN)</sub>	V
I <sub>IK</sub>	input clamping current	input EN: V <sub>I(EN)</sub> < -0.5 V	-50	-	mA
I <sub>SK</sub>	switch clamping current	input VIN: V <sub>I(VIN)</sub> < -0.5 V	-50	-	mA
		output VOUT: V <sub>O(VOUT)</sub> < -0.5 V	-50	-	mA
		output VOUT: V <sub>O(VOUT)</sub> > V <sub>I(VIN)</sub> + 0.5 V	-	50	mA
I <sub>SW</sub>	switch current	V <sub>SW</sub> > -0.5 V			
		T <sub>amb</sub> = 25 °C	-	±1000	mA
		T <sub>amb</sub> = 85 °C	-	±500	mA
T <sub>j(max)</sub>	maximum junction temperature		-40	+125	°C
T <sub>stg</sub>	storage temperature		-65	+150	°C
P <sub>tot</sub>	total power dissipation	<sup>[3]</sup>	-	300	mW

[1] The minimum input voltage rating may be exceeded if the input current rating is observed.

[2] The minimum and maximum switch voltage ratings may be exceeded if the switch clamping current rating is observed.

[3] The (absolute) maximum power dissipation depends on the junction temperature T<sub>j</sub>. Higher power dissipation is allowed in conjunction with lower ambient temperatures. The conditions to determine the specified values are T<sub>amb</sub> = 85 °C and the use of a two layer PCB.

## 9. Recommended operating conditions

Table 6. Recommended operating conditions

Symbol	Parameter	Conditions	Min	Max	Unit
$V_I$	input voltage		1.1	3.6	V
$T_{amb}$	ambient temperature		-40	+85	°C

## 10. Thermal characteristics

Table 7. Thermal characteristics

Symbol	Parameter	Conditions	Typ	Unit
$R_{th(j-a)}$	thermal resistance from junction to ambient		[1][2] 130	K/W

- [1] The overall  $R_{th(j-a)}$  can vary depending on the board layout. To minimize the effective  $R_{th(j-a)}$ , all pins must have a solid connection to larger Cu layer areas e.g. to the power and ground layer. In multi-layer PCB applications, the second layer should be used to create a large heat spreader area right below the device. If this layer is either ground or power, it should be connected with several vias to the top layer connecting to the device ground or supply. Try not to use any solder-stop varnish under the chip.
- [2] Rely on the measurement data given for a rough estimation of the  $R_{th(j-a)}$  in the application. The actual  $R_{th(j-a)}$  value may vary in applications using different layer stacks and layouts.

## 11. Static characteristics

Table 8. Static characteristics

$V_{I(VIN)} = 0.9\text{ V to }3.6\text{ V}$ , unless otherwise specified; Voltages are referenced to GND (ground = 0 V).

Symbol	Parameter	Conditions	$T_{amb} = 25\text{ °C}$			$T_{amb} = -40\text{ °C to }+85\text{ °C}$		Unit
			Min	Typ	Max	Min	Max	
$V_{IH}$	HIGH-level input voltage	EN input						
		$V_{I(VIN)} = 1.1\text{ V to }1.3\text{ V}$	-	-	-	1.0	-	V
		$V_{I(VIN)} = 1.3\text{ V to }1.8\text{ V}$	-	-	-	1.2	-	V
		$V_{I(VIN)} = 1.8\text{ V to }3.6\text{ V}$	-	-	-	1.2	-	V
$V_{IL}$	LOW-level input voltage	EN input						
		$V_{I(VIN)} = 1.1\text{ V to }1.3\text{ V}$	-	-	-	-	0.3	V
		$V_{I(VIN)} = 1.3\text{ V to }1.8\text{ V}$	-	-	-	-	0.4	V
		$V_{I(VIN)} = 1.8\text{ V to }3.6\text{ V}$	-	-	-	-	0.45	V
$I_I$	input leakage current	$V_{I(EN)} = 0\text{ V or }3.6\text{ V}$	-	0.1	-	-	500	nA
$I_{GND}$	ground current	$V_{I(EN)} = 0\text{ V or }3.6\text{ V}$ ; VOUT open; see <a href="#">Figure 5</a> and <a href="#">Figure 6</a>	-	-	-	-2	-	μA
$I_{S(OFF)}$	OFF-state leakage current	$V_{I(VIN)} = 3.6\text{ V}$ ; $V_{I(EN)} = \text{GND}$ ; $V_{I(VOUT)} = \text{GND}$ ; see <a href="#">Figure 8</a>	-	10	-	-	600	nA
$R_{dch}$	discharge resistance	VOUT output; $V_{I(VIN)} = 3.3\text{ V}$	-	90	-	-	120	Ω

11.1 Graphs

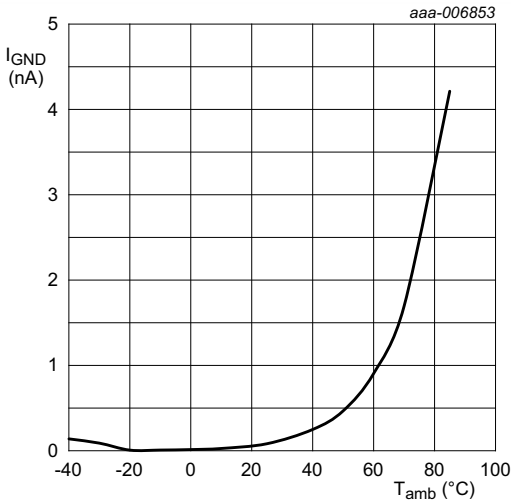

$V_{I(VIN)} = 1.8 \text{ V}; V_{I(EN)} = 1.8 \text{ V}; I_{LOAD} = 500 \text{ mA}.$

Fig 5. Ground current versus temperature

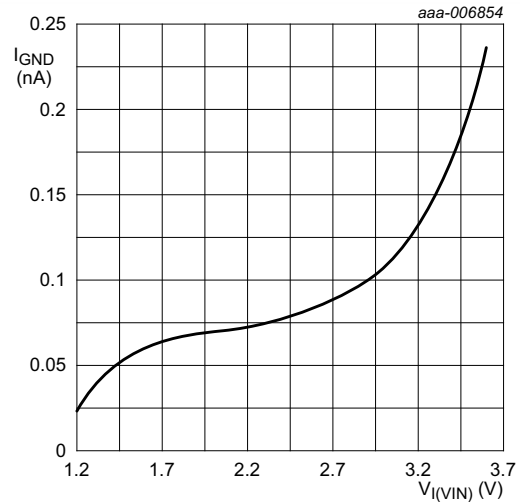

$V_{I(EN)} = V_{I(VIN)}; T_{amb} = 25 \text{ °C}; I_{LOAD} = 500 \text{ mA}.$

Fig 6. Ground current versus input voltage on pin VIN

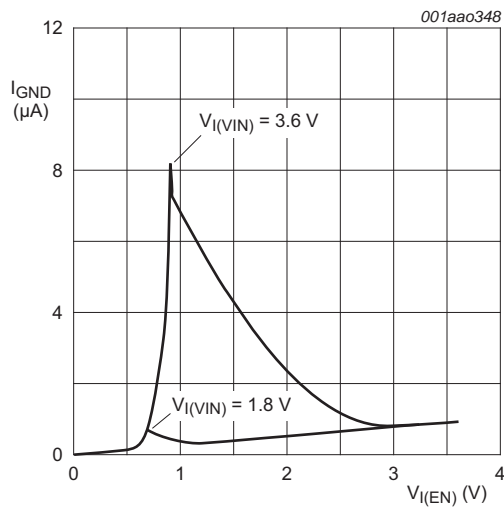
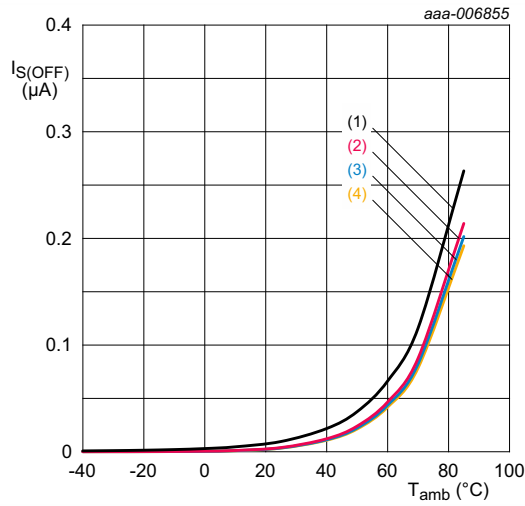

Fig 7. Additional ground current versus input voltage



- $V_{I(EN)} = \text{GND}$ .
- (1)  $V_{I(VIN)} = 3.6 \text{ V}$ .
  - (2)  $V_{I(VIN)} = 2.5 \text{ V}$ .
  - (3)  $V_{I(VIN)} = 1.8 \text{ V}$ .
  - (4)  $V_{I(VIN)} = 1.2 \text{ V}$ .

**Fig 8. OFF-state leakage current versus temperature**

## 11.2 ON resistance

**Table 9. ON resistance**

At recommended operating conditions; voltages are referenced to GND (ground = 0 V).

Symbol	Parameter	Conditions	$T_{\text{amb}} = -40 \text{ }^\circ\text{C to } +85 \text{ }^\circ\text{C}$			Unit
			Min	Typ <sup>[1]</sup>	Max	
$R_{\text{ON}}$	ON resistance	$V_{I(EN)} = 1.5 \text{ V}; I_{\text{LOAD}} = 200 \text{ mA};$ see <a href="#">Figure 9</a> , <a href="#">Figure 10</a> and <a href="#">Figure 11</a>				
		$V_{I(VIN)} = 1.2 \text{ V}$	-	150	-	mΩ
		$V_{I(VIN)} = 1.5 \text{ V}$	-	110	-	mΩ
		$V_{I(VIN)} = 1.8 \text{ V}$	-	95	130	mΩ
		$V_{I(VIN)} = 2.5 \text{ V}$	-	75	-	mΩ
		$V_{I(VIN)} = 3.6 \text{ V}$	-	65	-	mΩ

[1] Typical values are measured at  $T_{\text{amb}} = 25 \text{ }^\circ\text{C}$ .

11.3 ON resistance test circuit and waveforms

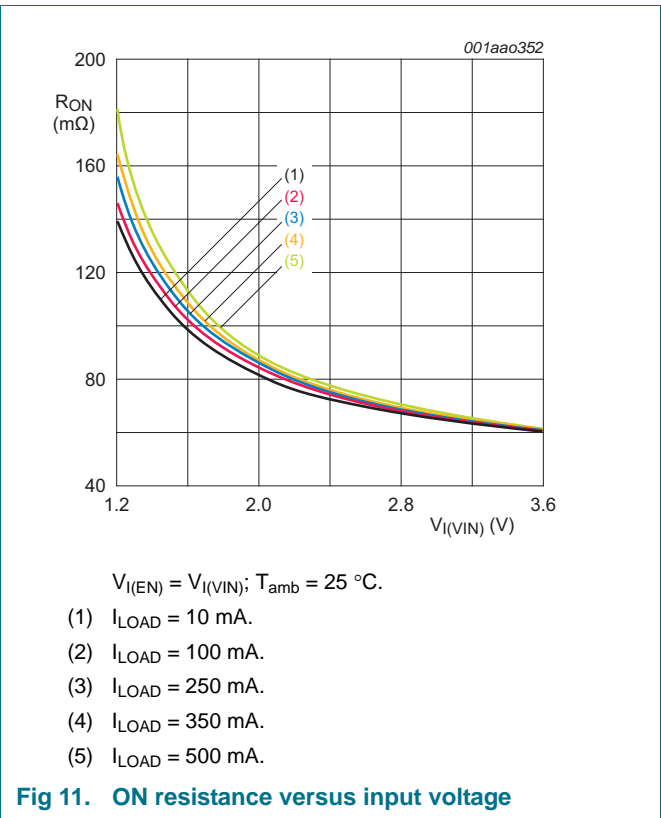
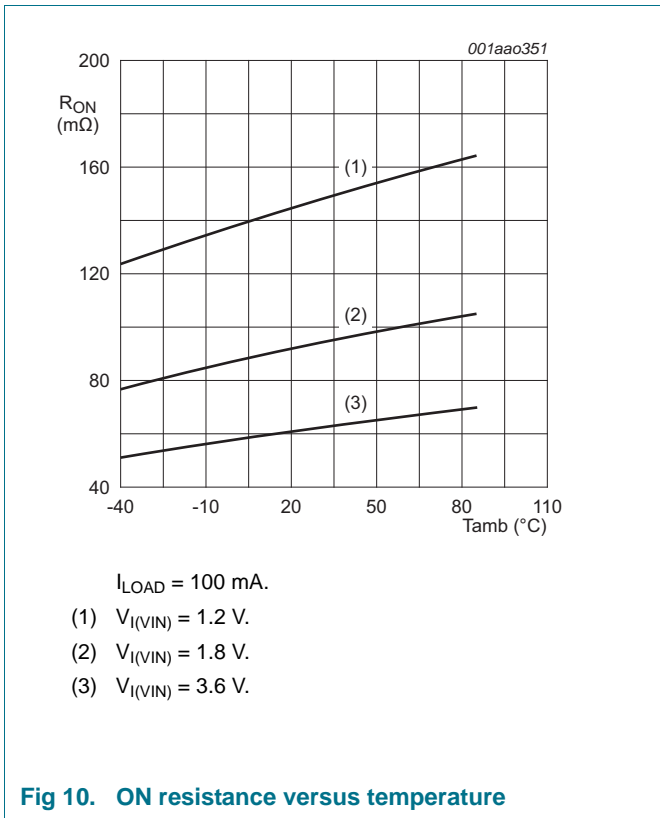
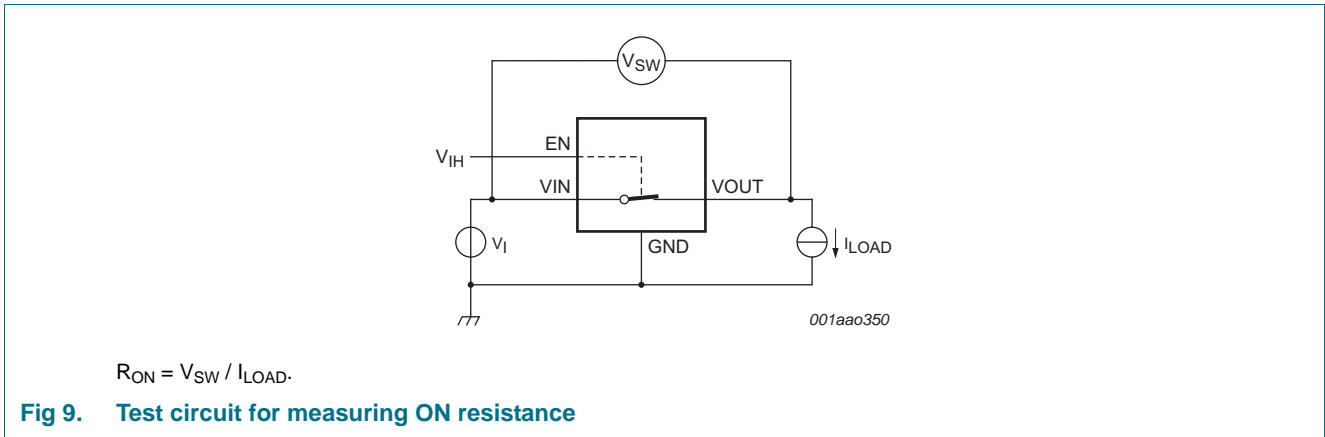

## 12. Dynamic characteristics

**Table 10. Dynamic characteristics**

At recommended operating conditions; voltages are referenced to GND (ground = 0 V); for test circuit see [Figure 12](#) and [Figure 13](#).

Symbol	Parameter	Conditions	T <sub>amb</sub> = -40 °C to +85 °C			Unit
			Min	Typ <sup>[1]</sup>	Max	
t <sub>en</sub>	enable time	EN to VOUT; see <a href="#">Figure 14</a>				
		V <sub>I(VIN)</sub> = 1.8 V	175	310	-	μs
		V <sub>I(VIN)</sub> = 3.3 V	80	135	-	μs
t <sub>dis</sub>	disable time	EN to VOUT; see <a href="#">Figure 14</a>				
		V <sub>I(VIN)</sub> = 1.8 V	-	10	-	μs
		V <sub>I(VIN)</sub> = 3.3 V	-	8	-	μs
t <sub>on</sub>	turn-on time	EN to VOUT; see <a href="#">Figure 14</a> and <a href="#">Figure 15</a>				
		V <sub>I(VIN)</sub> = 1.8 V	285	570	-	μs
		V <sub>I(VIN)</sub> = 3.3 V	150	280	-	μs
t <sub>off</sub>	turn-off time	EN to VOUT; see <a href="#">Figure 16</a> and <a href="#">Figure 17</a>				
		V <sub>I(VIN)</sub> = 1.8 V	-	200	-	μs
		V <sub>I(VIN)</sub> = 3.3 V	-	180	-	μs
t <sub>TLH</sub>	LOW to HIGH output transition time	VOUT				
		V <sub>I(VIN)</sub> = 1.8 V	110	265	-	μs
		V <sub>I(VIN)</sub> = 3.3 V	70	150	-	μs
t <sub>THL</sub>	HIGH to LOW output transition time	VOUT				
		V <sub>I(VIN)</sub> = 1.8 V	-	190	-	μs
		V <sub>I(VIN)</sub> = 3.3 V	-	172	-	μs

[1] Typical values are measured at T<sub>amb</sub> = 25 °C.



12.1 Waveforms and test circuits

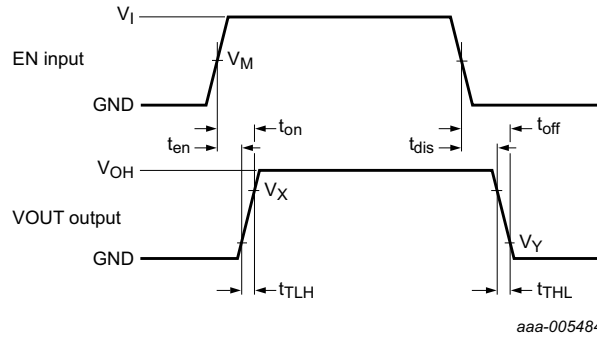

Measurement points are given in [Table 11](#).

Logic level:  $V_{OH}$  is the typical output voltage that occurs with the output load.

Fig 12. Switching times

Table 11. Measurement points

Supply voltage	EN Input		Output		
$V_{I(VIN)}$	$V_M$	$t_r, t_f$	$V_M$	$V_X$	$V_Y$
1.1 V to 3.6 V	$0.5 \times V_{I(EN)}$	$\leq 100$ ns	$0.5 \times V_{OH}$	$0.9 \times V_{OH}$	$0.1 \times V_{OH}$

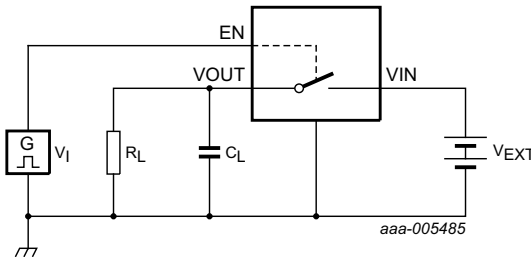

Test data is given in [Table 12](#).

Definitions test circuit:

$R_L$  = Load resistance.

$C_L$  = Load capacitance including jig and probe capacitance.

$V_{EXT}$  = External voltage for measuring switching times.

Fig 13. Test circuit for measuring switching times

Table 12. Test data

Supply voltage	EN Input	Load	
$V_{EXT}$	$V_{I(EN)}$	$C_L$	$R_L$
1.1 V to 3.6 V	1.8 V	1 $\mu$ F	500 $\Omega$

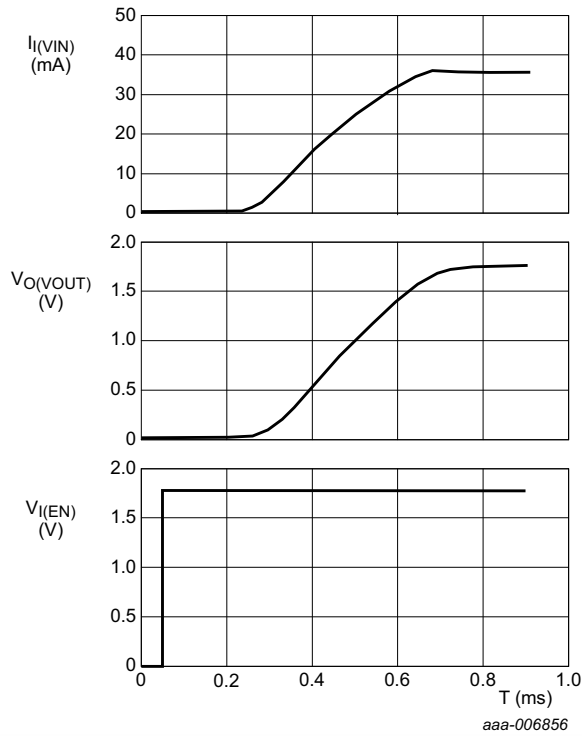

$V_{I(VIN)} = 1.8\text{ V}; V_{I(EN)} = 1.8\text{ V}; R_L = 50\ \Omega; C_L = 1\ \mu\text{F}.$

**Fig 14. Turn-on time**

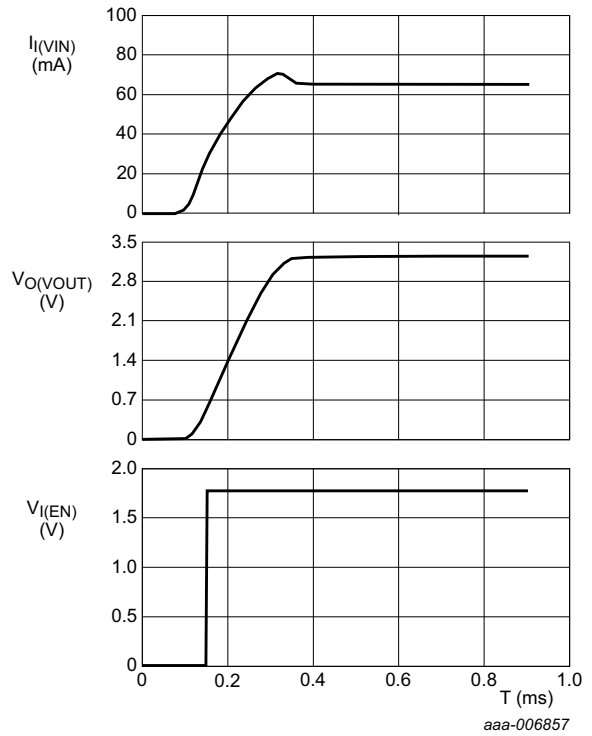

$V_{I(VIN)} = 3.3\text{ V}; V_{I(EN)} = 1.8\text{ V}; R_L = 50\ \Omega; C_L = 1\ \mu\text{F}.$

**Fig 15. Turn-on time**

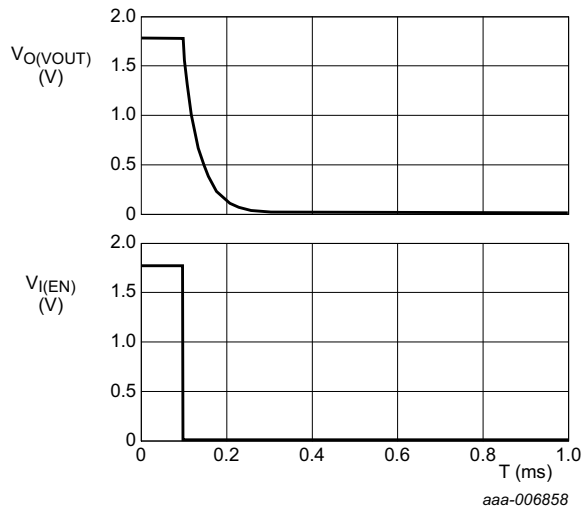

$V_{I(VIN)} = 1.8\text{ V}; V_{I(EN)} = 1.8\text{ V}; R_L = 50\ \Omega; C_L = 1\ \mu\text{F}.$

**Fig 16. Turn-off time**

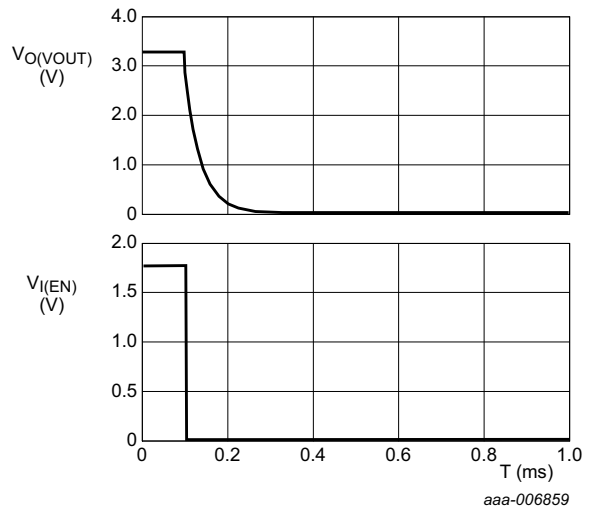

$V_{I(VIN)} = 3.3\text{ V}; V_{I(EN)} = 1.8\text{ V}; R_L = 50\ \Omega; C_L = 1\ \mu\text{F}.$

**Fig 17. Turn-off time**

### 13. Package outline

WLCSP4: wafer level chip-scale package; 4 bumps; 0.77 x 0.77 x 0.51 mm (Backside coating included)

NX3P2902B

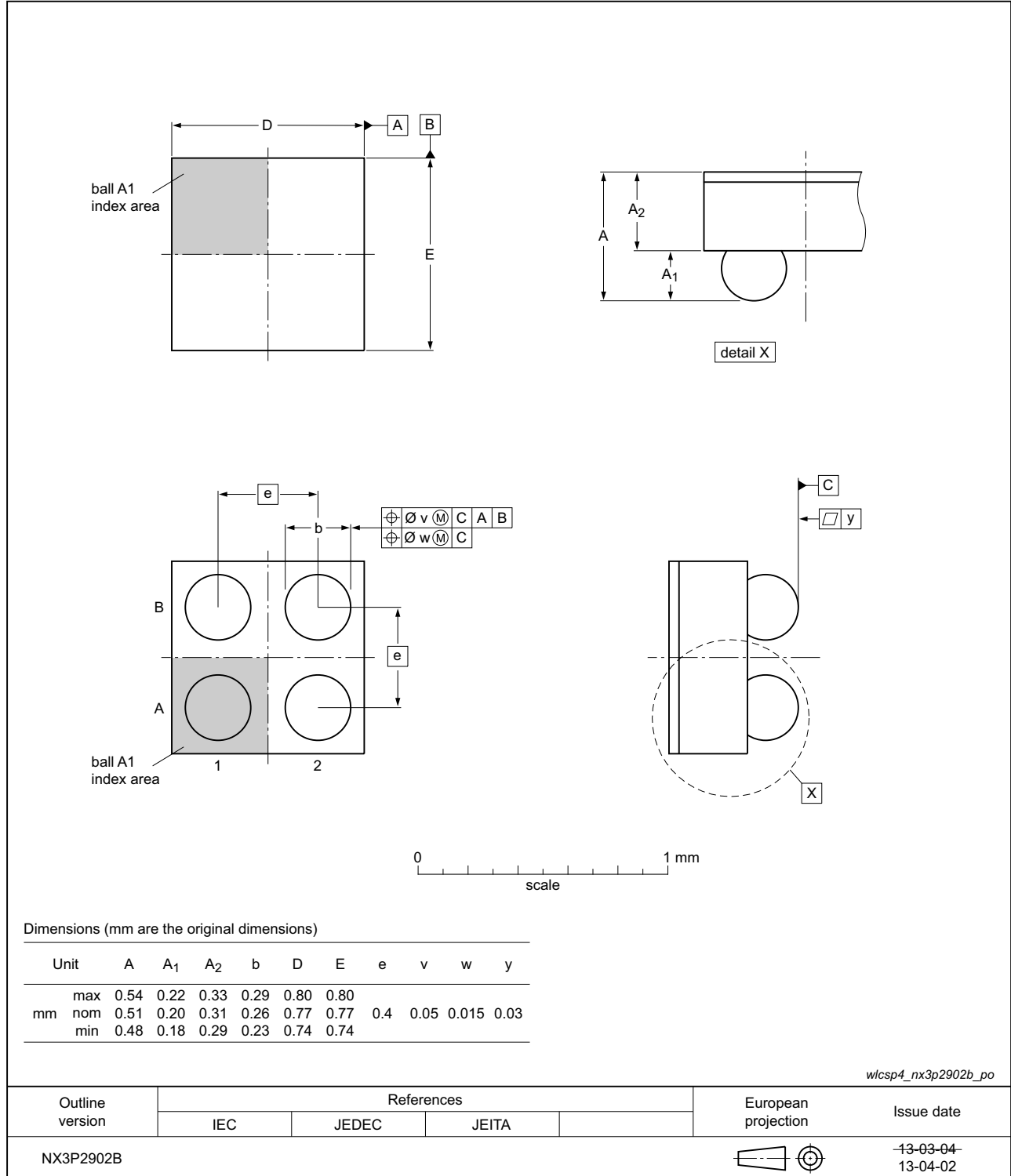

Fig 18. Package outline WLCSP4 (NX3P2902B)

## 14. Abbreviations

Table 13. Abbreviations

Acronym	Description
CDM	Charged Device Model
ESD	ElectroStatic Discharge
HBM	Human Body Model
MOSFET	Metal-Oxide Semiconductor Field Effect Transistor

## 15. Revision history

Table 14. Revision history

Document ID	Release date	Data sheet status	Change notice	Supersedes
NX3P2902B v.2	20180222	Product data sheet	-	NX3P2902B v.1.1
Modifications:	<ul style="list-style-type: none"> <li>Updated <a href="#">Section 4 "Ordering information"</a></li> </ul>			
NX3P2902B v.1.1	20161101	Product data sheet	-	NX3P2902B v.1
Modifications:	<ul style="list-style-type: none"> <li><a href="#">Table 8</a>: Updated OFF-state current specification</li> </ul>			
NX3P2902B v.1	20130429	Product data sheet	-	-

## 16. Legal information

### 16.1 Data sheet status

Document status <sup>[1][2]</sup>	Product status <sup>[3]</sup>	Definition
Objective [short] data sheet	Development	This document contains data from the objective specification for product development.
Preliminary [short] data sheet	Qualification	This document contains data from the preliminary specification.
Product [short] data sheet	Production	This document contains the product specification.

[1] Please consult the most recently issued document before initiating or completing a design.

[2] The term 'short data sheet' is explained in section "Definitions".

[3] The product status of device(s) described in this document may have changed since this document was published and may differ in case of multiple devices. The latest product status information is available on the Internet at URL <http://www.nxp.com>.

### 16.2 Definitions

**Draft** — The document is a draft version only. The content is still under internal review and subject to formal approval, which may result in modifications or additions. NXP Semiconductors does not give any representations or warranties as to the accuracy or completeness of information included herein and shall have no liability for the consequences of use of such information.

**Short data sheet** — A short data sheet is an extract from a full data sheet with the same product type number(s) and title. A short data sheet is intended for quick reference only and should not be relied upon to contain detailed and full information. For detailed and full information see the relevant full data sheet, which is available on request via the local NXP Semiconductors sales office. In case of any inconsistency or conflict with the short data sheet, the full data sheet shall prevail.

**Product specification** — The information and data provided in a Product data sheet shall define the specification of the product as agreed between NXP Semiconductors and its customer, unless NXP Semiconductors and customer have explicitly agreed otherwise in writing. In no event however, shall an agreement be valid in which the NXP Semiconductors product is deemed to offer functions and qualities beyond those described in the Product data sheet.

### 16.3 Disclaimers

**Limited warranty and liability** — Information in this document is believed to be accurate and reliable. However, NXP Semiconductors does not give any representations or warranties, expressed or implied, as to the accuracy or completeness of such information and shall have no liability for the consequences of use of such information. NXP Semiconductors takes no responsibility for the content in this document if provided by an information source outside of NXP Semiconductors.

In no event shall NXP Semiconductors be liable for any indirect, incidental, punitive, special or consequential damages (including - without limitation - lost profits, lost savings, business interruption, costs related to the removal or replacement of any products or rework charges) whether or not such damages are based on tort (including negligence), warranty, breach of contract or any other legal theory.

Notwithstanding any damages that customer might incur for any reason whatsoever, NXP Semiconductors' aggregate and cumulative liability towards customer for the products described herein shall be limited in accordance with the *Terms and conditions of commercial sale* of NXP Semiconductors.

**Right to make changes** — NXP Semiconductors reserves the right to make changes to information published in this document, including without limitation specifications and product descriptions, at any time and without notice. This document supersedes and replaces all information supplied prior to the publication hereof.

**Suitability for use** — NXP Semiconductors products are not designed, authorized or warranted to be suitable for use in life support, life-critical or safety-critical systems or equipment, nor in applications where failure or malfunction of an NXP Semiconductors product can reasonably be expected to result in personal injury, death or severe property or environmental damage. NXP Semiconductors and its suppliers accept no liability for inclusion and/or use of NXP Semiconductors products in such equipment or applications and therefore such inclusion and/or use is at the customer's own risk.

**Applications** — Applications that are described herein for any of these products are for illustrative purposes only. NXP Semiconductors makes no representation or warranty that such applications will be suitable for the specified use without further testing or modification.

Customers are responsible for the design and operation of their applications and products using NXP Semiconductors products, and NXP Semiconductors accepts no liability for any assistance with applications or customer product design. It is customer's sole responsibility to determine whether the NXP Semiconductors product is suitable and fit for the customer's applications and products planned, as well as for the planned application and use of customer's third party customer(s). Customers should provide appropriate design and operating safeguards to minimize the risks associated with their applications and products.

NXP Semiconductors does not accept any liability related to any default, damage, costs or problem which is based on any weakness or default in the customer's applications or products, or the application or use by customer's third party customer(s). Customer is responsible for doing all necessary testing for the customer's applications and products using NXP Semiconductors products in order to avoid a default of the applications and the products or of the application or use by customer's third party customer(s). NXP does not accept any liability in this respect.

**Limiting values** — Stress above one or more limiting values (as defined in the Absolute Maximum Ratings System of IEC 60134) will cause permanent damage to the device. Limiting values are stress ratings only and (proper) operation of the device at these or any other conditions above those given in the Recommended operating conditions section (if present) or the Characteristics sections of this document is not warranted. Constant or repeated exposure to limiting values will permanently and irreversibly affect the quality and reliability of the device.

**Terms and conditions of commercial sale** — NXP Semiconductors products are sold subject to the general terms and conditions of commercial sale, as published at <http://www.nxp.com/profile/terms>, unless otherwise agreed in a valid written individual agreement. In case an individual agreement is concluded only the terms and conditions of the respective agreement shall apply. NXP Semiconductors hereby expressly objects to applying the customer's general terms and conditions with regard to the purchase of NXP Semiconductors products by customer.

**No offer to sell or license** — Nothing in this document may be interpreted or construed as an offer to sell products that is open for acceptance or the grant, conveyance or implication of any license under any copyrights, patents or other industrial or intellectual property rights.

**Export control** — This document as well as the item(s) described herein may be subject to export control regulations. Export might require a prior authorization from competent authorities.

**Non-automotive qualified products** — Unless this data sheet expressly states that this specific NXP Semiconductors product is automotive qualified, the product is not suitable for automotive use. It is neither qualified nor tested in accordance with automotive testing or application requirements. NXP Semiconductors accepts no liability for inclusion and/or use of non-automotive qualified products in automotive equipment or applications.

In the event that customer uses the product for design-in and use in automotive applications to automotive specifications and standards, customer (a) shall use the product without NXP Semiconductors' warranty of the product for such automotive applications, use and specifications, and (b) whenever customer uses the product for automotive applications beyond

NXP Semiconductors' specifications such use shall be solely at customer's own risk, and (c) customer fully indemnifies NXP Semiconductors for any liability, damages or failed product claims resulting from customer design and use of the product for automotive applications beyond NXP Semiconductors' standard warranty and NXP Semiconductors' product specifications.

**Translations** — A non-English (translated) version of a document is for reference only. The English version shall prevail in case of any discrepancy between the translated and English versions.

## 16.4 Trademarks

Notice: All referenced brands, product names, service names and trademarks are the property of their respective owners.

## 17. Contact information

For more information, please visit: <http://www.nxp.com>

For sales office addresses, please send an email to: [salesaddresses@nxp.com](mailto:salesaddresses@nxp.com)

## 18. Contents

---

<b>1</b>	<b>General description</b> . . . . .	<b>1</b>
<b>2</b>	<b>Features and benefits</b> . . . . .	<b>1</b>
<b>3</b>	<b>Applications</b> . . . . .	<b>1</b>
<b>4</b>	<b>Ordering information</b> . . . . .	<b>2</b>
4.1	Ordering options . . . . .	2
<b>5</b>	<b>Functional diagram</b> . . . . .	<b>2</b>
<b>6</b>	<b>Pinning information</b> . . . . .	<b>2</b>
6.1	Pinning . . . . .	2
6.2	Pin description . . . . .	3
<b>7</b>	<b>Functional description</b> . . . . .	<b>3</b>
<b>8</b>	<b>Limiting values</b> . . . . .	<b>3</b>
<b>9</b>	<b>Recommended operating conditions</b> . . . . .	<b>4</b>
<b>10</b>	<b>Thermal characteristics</b> . . . . .	<b>4</b>
<b>11</b>	<b>Static characteristics</b> . . . . .	<b>4</b>
11.1	Graphs . . . . .	5
11.2	ON resistance . . . . .	6
11.3	ON resistance test circuit and waveforms . . . . .	7
<b>12</b>	<b>Dynamic characteristics</b> . . . . .	<b>8</b>
12.1	Waveforms and test circuits . . . . .	9
<b>13</b>	<b>Package outline</b> . . . . .	<b>11</b>
<b>14</b>	<b>Abbreviations</b> . . . . .	<b>12</b>
<b>15</b>	<b>Revision history</b> . . . . .	<b>12</b>
<b>16</b>	<b>Legal information</b> . . . . .	<b>13</b>
16.1	Data sheet status . . . . .	13
16.2	Definitions . . . . .	13
16.3	Disclaimers . . . . .	13
16.4	Trademarks . . . . .	14
<b>17</b>	<b>Contact information</b> . . . . .	<b>14</b>
<b>18</b>	<b>Contents</b> . . . . .	<b>15</b>

Please be aware that important notices concerning this document and the product(s) described herein, have been included in section 'Legal information'.

© NXP Semiconductors N.V. 2018.

All rights reserved.

For more information, please visit: <http://www.nxp.com>

For sales office addresses, please send an email to: [salesaddresses@nxp.com](mailto:salesaddresses@nxp.com)

Date of release: 22 February 2018

Document identifier: NX3P2902B