

NVC3S5A51PLZ

Power MOSFET

–60V, 250mΩ, –1.8A, P-Channel



ON Semiconductor®

www.onsemi.com

Automotive Power MOSFET designed to minimize gate charge and low on resistance. AEC-Q101 qualified MOSFET and PPAP capable suitable for automotive applications.

Features

- 4V drive
- High ESD protection
- Low On-Resistance
- AEC-Q101 qualified and PPAP capable
- Pb-Free, Halogen Free and RoHS compliance

Typical Applications

- Reverse Battery Protection
- High Side Load Switch
- Automotive Body Controllers

SPECIFICATIONS

ABSOLUTE MAXIMUM RATING at Ta = 25°C (Note 1)

Parameter	Symbol	Value	Unit
Drain to Source Voltage	V _{DSS}	–60	V
Gate to Source Voltage	V _{GSS}	±20	V
Drain Current (DC) (Note 2)	I _D	–1.8	A
Drain Current (DC) (Note 3)		–1.7	A
Drain Current (Pulse) PW ≤ 10μs, duty cycle ≤ 1%	I _{DP}	–7.2	A
Power Dissipation Ta=25°C(Note 2)	P _D	1.2	W
Power Dissipation Ta=25°C(Note 3)		0.8	W
Junction Temperature and Storage Temperature	T _j , T _{stg}	–55 to +175	°C

Note 1 : Stresses exceeding those listed in the Maximum Ratings table may damage the device. If any of these limits are exceeded, device functionality should not be assumed, damage may occur and reliability may be affected.

THERMAL RESISTANCE RATINGS

Parameter	Symbol	Value	Unit
Junction to Ambient	R _{θJA}	125	°C/W
		182	°C/W

Note 2 : Surface mounted on ceramic substrate(900mm² × 0.8mm).

Note 3 : Surface mounted on FR4 board using a 92mm², 1 oz. Cu pad.

V _{DSS}	R _{DS(on)} Max	I _D Max
–60V	250mΩ@ –10V	–1.8A
	330mΩ@ –4.5V	
	350mΩ@ –4.0V	

ELECTRICAL CONNECTION P-Channel

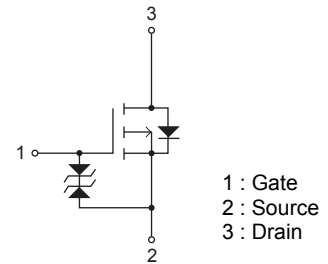

MARKING



ORDERING INFORMATION

See detailed ordering and shipping information on page 6 of this data sheet.

NVC3S5A51PLZ

ELECTRICAL CHARACTERISTICS at Ta = 25°C (Note 4)

Parameter	Symbol	Conditions	Value			Unit
			min	typ	max	
Drain to Source Breakdown Voltage	V(BR)DSS	ID=-1mA, VGS=0V	-60			V
Zero-Gate Voltage Drain Current	IDSS	VDS=-60V, VGS=0V			-1	μA
Gate to Source Leakage Current	IGSS	VGS=±16V, VDS=0V			±10	μA
Gate Threshold Voltage	VGS(th)	VDS=-10V, ID=-1mA	-1.2		-2.6	V
Forward Transconductance	gFS	VDS=-10V, ID=-1A		2.7		S
Static Drain to Source On-State Resistance	RDS(on)	ID=-1A, VGS=-10V		190	250	mΩ
		ID=-0.5A, VGS=-4.5V		235	330	mΩ
		ID=-0.5A, VGS=-4V		250	350	mΩ
Input Capacitance	Ciss	VDS=-20V, f=1MHz		262		pF
Output Capacitance	Coss			29		pF
Reverse Transfer Capacitance	Crss			19		pF
Turn-ON Delay Time	t _{d(on)}		See Fig. 1		5.1	
Rise Time	t _r			5.4		ns
Turn-OFF Delay Time	t _{d(off)}			34		ns
Fall Time	t _f			19		ns
Total Gate Charge	Qg	VDS=-30V, VGS=-10V, ID=-1.8A		6.0		nC
Gate to Source Charge	Qgs			0.83		nC
Gate to Drain "Miller" Charge	Qgd			1.3		nC
Forward Diode Voltage	VSD		IS=-1.8A, VGS=0V		-0.82	-1.2

Note 4 : Product parametric performance is indicated in the Electrical Characteristics for the listed test conditions, unless otherwise noted. Product performance may not be indicated by the Electrical Characteristics if operated under different conditions.

Fig.1 Switching Time Test Circuit

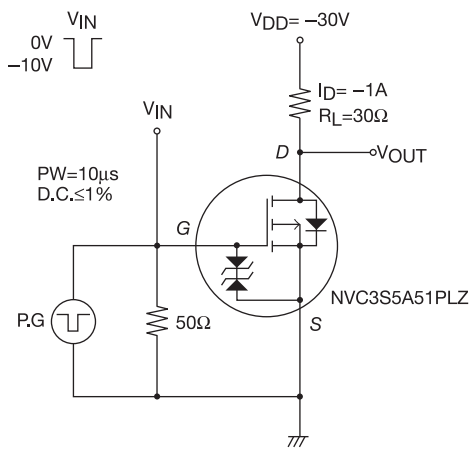

NVC3S5A51PLZ

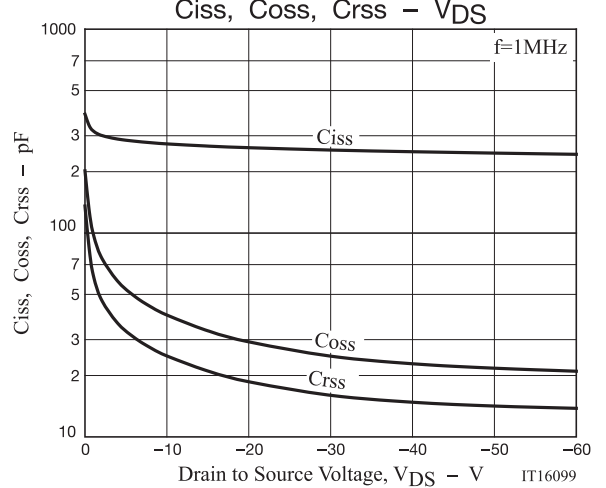
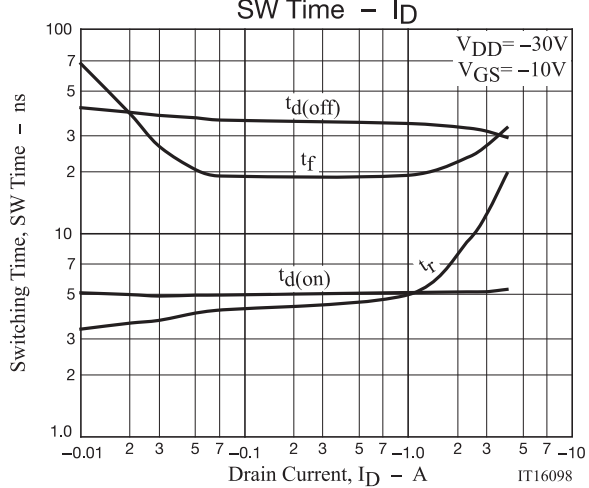
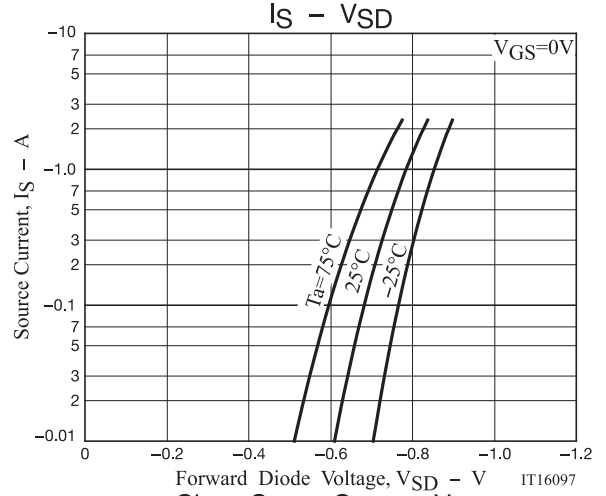
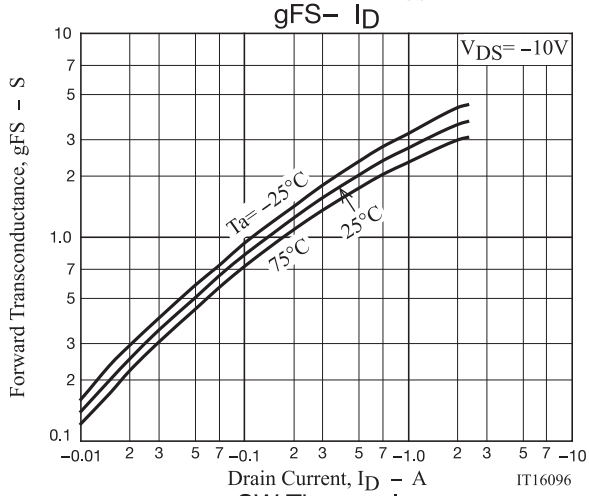
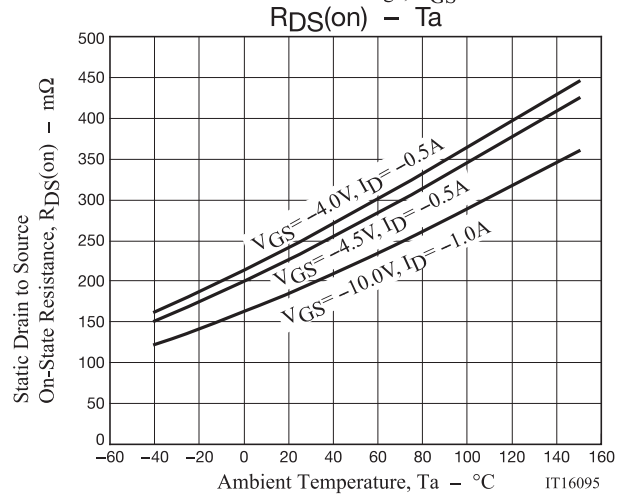
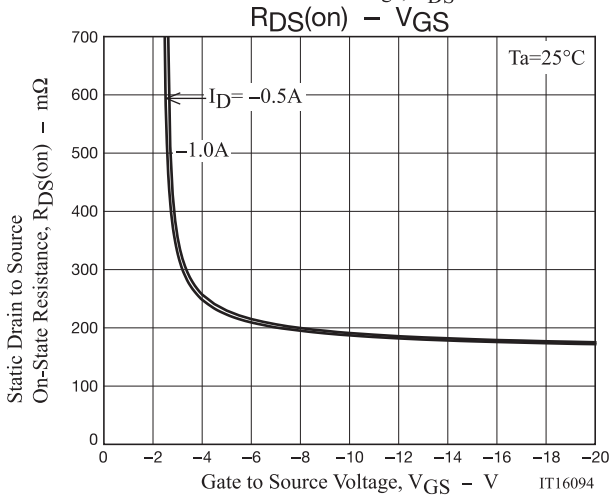
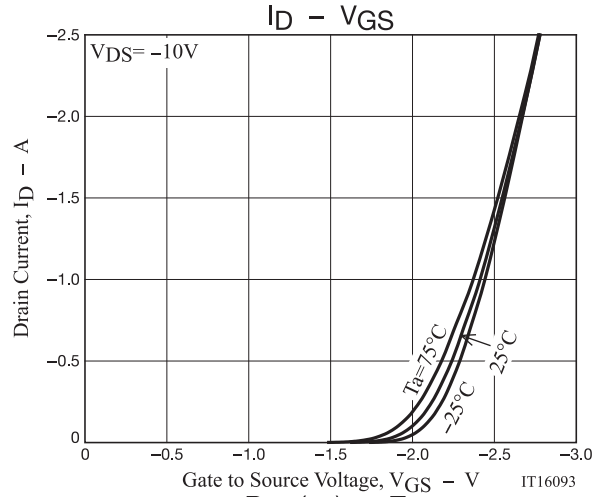
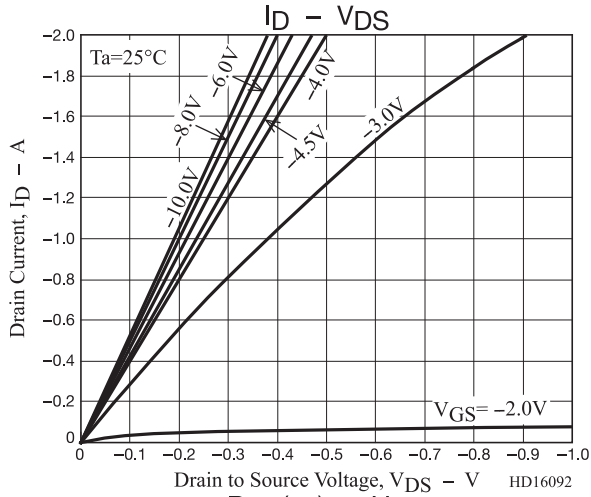

NVC3S5A51PLZ

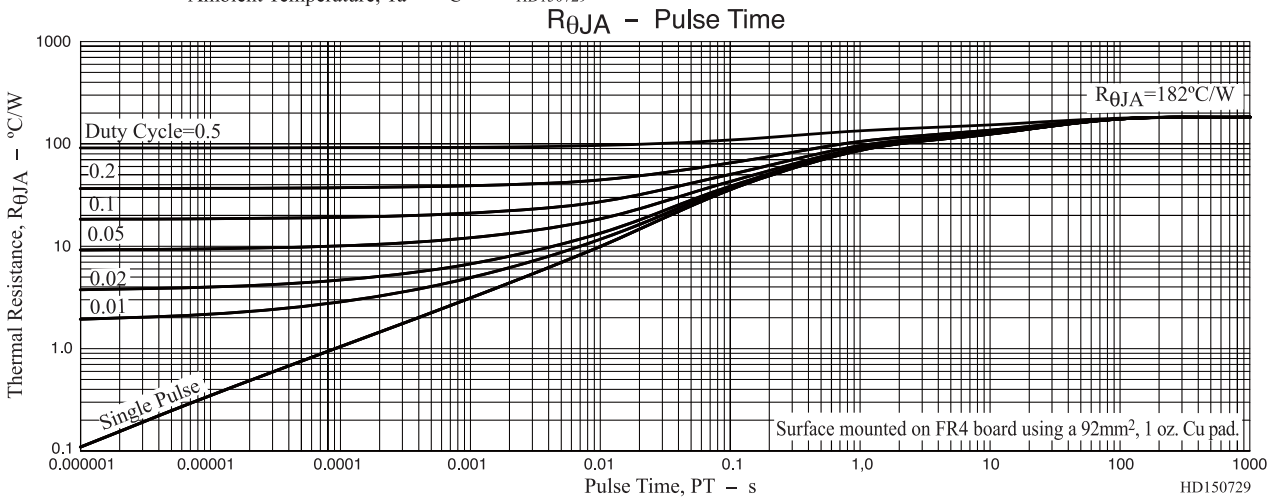
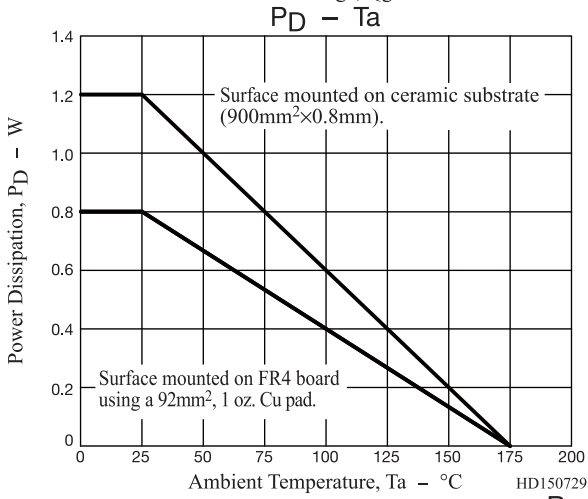
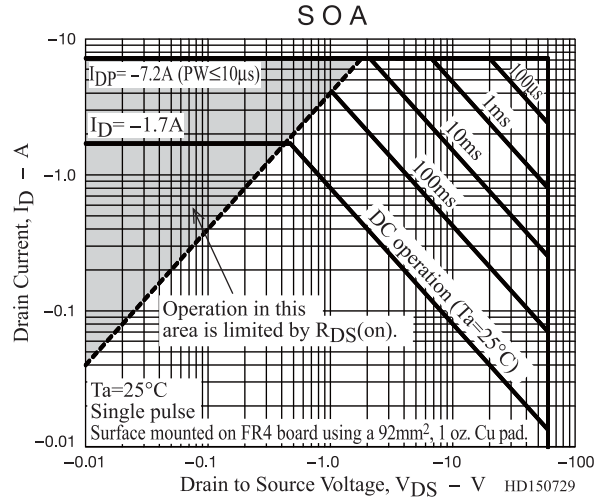
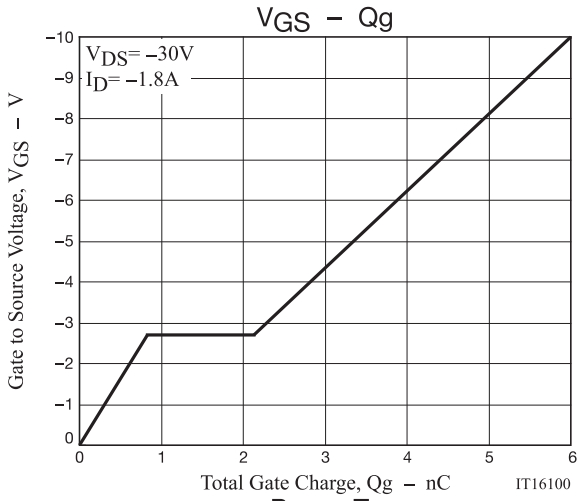

NVC3S5A51PLZ

PACKAGE DIMENSIONS

unit : mm

CPH3

CASE 318BA

ISSUE O

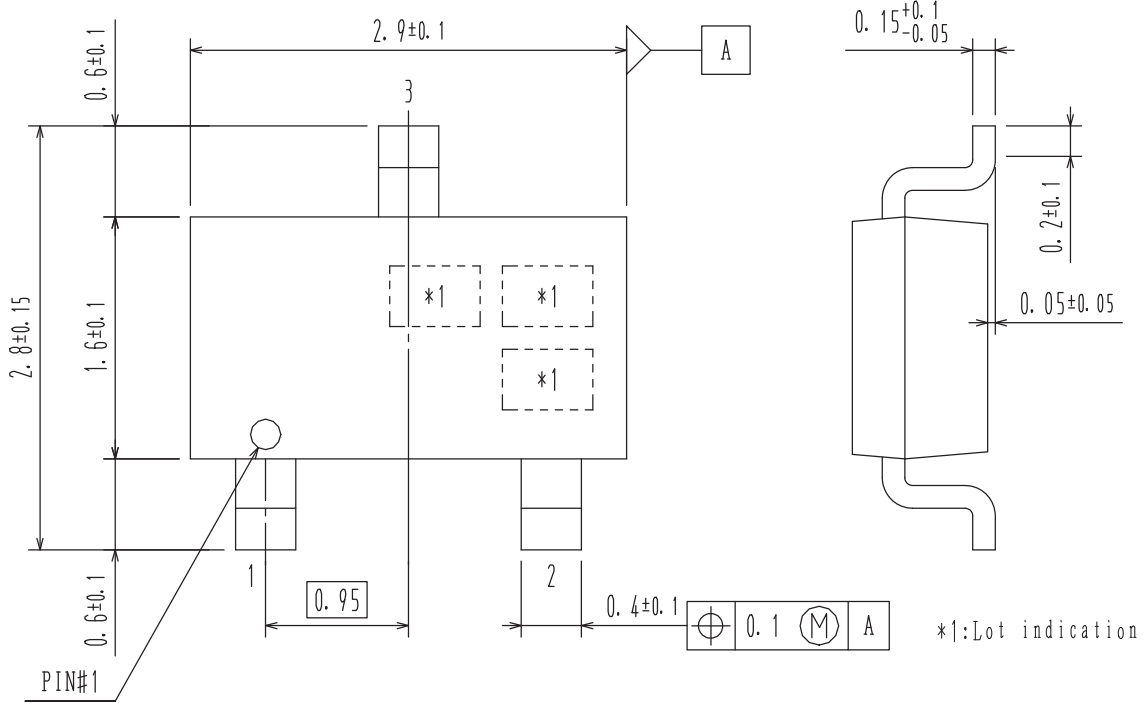

RECOMMENDED SOLDERING FOOTPRINT

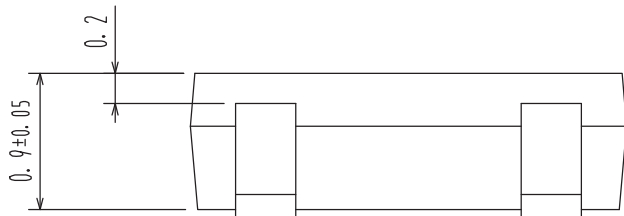

- 1 : Gate
- 2 : Source
- 3 : Drain

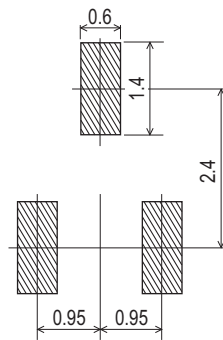

NVC3S5A51PLZ

ORDERING INFORMATION

Device	Marking	Package	Shipping (Qty / Packing)
NVC3S5A51PLZT1G	WH	CPH3 (Pb-Free / Halogen Free)	3,000 / Tape & Reel

† For information on tape and reel specifications, including part orientation and tape sizes, please refer to our Tape and Reel Packaging Specifications Brochure, BRD8011/D. http://www.onsemi.com/pub_link/Collateral/BRD8011-D.PDF

Note on usage : Since the NVC3S5A51PLZ is a MOSFET product, please avoid using this device in the vicinity of highly charged objects.

ON Semiconductor and the ON logo are registered trademarks of Semiconductor Components Industries, LLC (SCILLC) or its subsidiaries in the United States and/or other countries. SCILLC owns the rights to a number of patents, trademarks, copyrights, trade secrets, and other intellectual property. A listing of SCILLC's product/patent coverage may be accessed at www.onsemi.com/site/pdf/Patent-Marking.pdf. SCILLC reserves the right to make changes without further notice to any products herein. SCILLC makes no warranty, representation or guarantee regarding the suitability of its products for any particular purpose, nor does SCILLC assume any liability arising out of the application or use of any product or circuit, and specifically disclaims any and all liability, including without limitation special, consequential or incidental damages. "Typical" parameters which may be provided in SCILLC data sheets and/or specifications can and do vary in different applications and actual performance may vary over time. All operating parameters, including "Typicals" must be validated for each customer application by customer's technical experts. SCILLC does not convey any license under its patent rights nor the rights of others. SCILLC products are not designed, intended, or authorized for use as components in systems intended for surgical implant into the body, or other applications intended to support or sustain life, or for any other application in which the failure of the SCILLC product could create a situation where personal injury or death may occur. Should Buyer purchase or use SCILLC products for any such unintended or unauthorized application, Buyer shall indemnify and hold SCILLC and its officers, employees, subsidiaries, affiliates, and distributors harmless against all claims, costs, damages, and expenses, and reasonable attorney fees arising out of, directly or indirectly, any claim of personal injury or death associated with such unintended or unauthorized use, even if such claim alleges that SCILLC was negligent regarding the design or manufacture of the part. SCILLC is an Equal Opportunity/Affirmative Action Employer. This literature is subject to all applicable copyright laws and is not for resale in any manner.