

# NTMFS4933N

## Power MOSFET

30 V, 210 A, Single N-Channel, SO-8 FL

### Features

- Low  $R_{DS(on)}$  to Improve Conduction and Overall Efficiency
- These Devices are Pb-Free, Halogen Free/BFR Free and are RoHS Compliant

### Applications

- OR-ing FET, Power Load Switch, Motor Control
- Refer to Application Note AND8195/D for Mounting Information

### End Products

- Server, UPS, Fault-Tolerant Power Systems, Hot Swap

### MAXIMUM RATINGS ( $T_J = 25^\circ\text{C}$ unless otherwise stated)

| Parameter  | Symbol   | Value                     | Unit             |
|--|--|---------------------------|------------------|
| Drain-to-Source Voltage  | $V_{DS}$                                       | 30                        | V                |
| Gate-to-Source Voltage   | $V_{GS}$                                       | $\pm 20$                  | V                |
| Continuous Drain Current $R_{\theta JA}$ (Note 1)  | $I_D$  | $T_A = 25^\circ\text{C}$  | 34               |
|  |  | $T_A = 100^\circ\text{C}$ | 21.5             |
| Power Dissipation $R_{\theta JA}$ (Note 1)   | $P_D$  | 2.74                      | W                |
| Continuous Drain Current $R_{\theta JA} \leq 10$ s (Note 1)  | $I_D$  | $T_A = 25^\circ\text{C}$  | 43               |
|  |  | $T_A = 100^\circ\text{C}$ | 27               |
| Power Dissipation $R_{\theta JA} \leq 10$ s (Note 1)   | $P_D$  | 7.3                       | W                |
| Continuous Drain Current $R_{\theta JA}$ (Note 2)  | $I_D$  | $T_A = 25^\circ\text{C}$  | 20               |
|  |  | $T_A = 100^\circ\text{C}$ | 12.5             |
| Power Dissipation $R_{\theta JA}$ (Note 2)   | $P_D$  | 1.06                      | W                |
| Continuous Drain Current $R_{\theta JC}$ (Note 1)  | $I_D$  | $T_C = 25^\circ\text{C}$  | 210              |
|  |  | $T_C = 100^\circ\text{C}$ | 132              |
| Power Dissipation $R_{\theta JC}$ (Note 1)   | $P_D$  | 104                       | W                |
| Pulsed Drain Current   | $T_A = 25^\circ\text{C}, t_p = 10 \mu\text{s}$ | $I_{DM}$                  | 400              |
| Operating Junction and Storage Temperature   | $T_J, T_{STG}$                                 | -55 to +150               | $^\circ\text{C}$ |
| Source Current (Body Diode)  | $I_S$  | 95                        | A                |
| Drain to Source DV/dt  | $dV/dt$  | 4.4                       | V/ns             |
| Single Pulse Drain-to-Source Avalanche Energy ( $T_J = 25^\circ\text{C}, V_{DD} = 24$ V, $V_{GS} = 10$ V, $I_L = 58$ A <sub>pk</sub> , $L = 0.3$ mH, $R_G = 25 \Omega$ ) | $E_{AS}$                                       | 504                       | mJ               |
| Lead Temperature for Soldering Purposes (1/8" from case for 10 s)  | $T_L$  | 260                       | $^\circ\text{C}$ |

Stresses exceeding Maximum Ratings may damage the device. Maximum Ratings are stress ratings only. Functional operation above the Recommended Operating Conditions is not implied. Extended exposure to stresses above the Recommended Operating Conditions may affect device reliability.

1. Surface-mounted on FR4 board using 1 sq-in pad, 1 oz Cu.
2. Surface-mounted on FR4 board using the minimum recommended pad size. (Cu area = 50 mm<sup>2</sup> [1 oz])



ON Semiconductor®

<http://onsemi.com>

| $V_{(BR)DSS}$ | $R_{DS(ON)}$ MAX       | $I_D$ MAX |
|---------------|------------------------|-----------|
| 30 V          | 1.2 m $\Omega$ @ 10 V  | 210 A     |
|               | 2.0 m $\Omega$ @ 4.5 V |           |

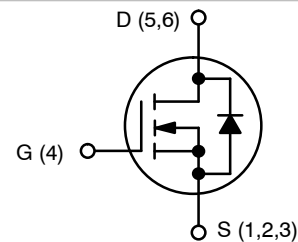

N-CHANNEL MOSFET

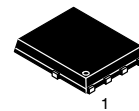

SO-8 FLAT LEAD  
CASE 488AA  
STYLE 1

### MARKING DIAGRAM

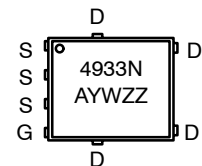

- A = Assembly Location
- Y = Year
- W = Work Week
- ZZ = Lot Traceability

### ORDERING INFORMATION

| Device        | Package           | Shipping†          |
|---------------|-------------------|--------------------|
| NTMFS4933NT1G | SO-8 FL (Pb-Free) | 1500 / Tape & Reel |
| NTMFS4933NT3G | SO-8 FL (Pb-Free) | 5000 / Tape & Reel |

†For information on tape and reel specifications, including part orientation and tape sizes, please refer to our Tape and Reel Packaging Specifications Brochure, BRD8011/D.

# NTMFS4933N

## THERMAL RESISTANCE MAXIMUM RATINGS

| Parameter                                       | Symbol          | Value | Unit |
|---|-----------------|-------|------|
| Junction-to-Case (Drain)                        | $R_{\theta JC}$ | 1.1   | °C/W |
| Junction-to-Ambient – Steady State (Note 3)     | $R_{\theta JA}$ | 45.6  |      |
| Junction-to-Ambient – Steady State (Note 4)     | $R_{\theta JA}$ | 117.5 |      |
| Junction-to-Ambient – ( $t \leq 10$ s) (Note 3) | $R_{\theta JA}$ | 17.13 |      |

3. Surface-mounted on FR4 board using 1 sq-in pad, 1 oz Cu.

4. Surface-mounted on FR4 board using the minimum recommended pad size. (Cu area = 50 mm<sup>2</sup> [1 oz])

## ELECTRICAL CHARACTERISTICS ( $T_J = 25^\circ\text{C}$ unless otherwise specified)

| Parameter | Symbol | Test Condition | Min | Typ | Max | Unit |
|-----------|--------|----------------|-----|-----|-----|------|
|-----------|--------|----------------|-----|-----|-----|------|

### OFF CHARACTERISTICS

|   |                   |                                     |                           |    |           |         |
|---|-------------------|-------------------------------------|---------------------------|----|-----------|---------|
| Drain-to-Source Breakdown Voltage                         | $V_{(BR)DSS}$     | $V_{GS} = 0$ V, $I_D = 250$ $\mu$ A | 30                        |    |           | V       |
| Drain-to-Source Breakdown Voltage Temperature Coefficient | $V_{(BR)DSS}/T_J$ |                                     |                           | 15 |           | mV/°C   |
| Zero Gate Voltage Drain Current                           | $I_{DSS}$         | $V_{GS} = 0$ V,<br>$V_{DS} = 24$ V  | $T_J = 25^\circ\text{C}$  |    | 1.0       | $\mu$ A |
|   |                   |                                     | $T_J = 125^\circ\text{C}$ |    | 10        |         |
| Gate-to-Source Leakage Current                            | $I_{GSS}$         | $V_{DS} = 0$ V, $V_{GS} = \pm 20$ V |                           |    | $\pm 100$ | nA      |

### ON CHARACTERISTICS (Note 5)

|  |                  |   |              |     |     |       |            |
|--|------------------|---|--------------|-----|-----|-------|------------|
| Gate Threshold Voltage                     | $V_{GS(TH)}$     | $V_{GS} = V_{DS}$ , $I_D = 250$ $\mu$ A | 1.2          | 1.6 | 2.2 | V     |            |
| Negative Threshold Temperature Coefficient | $V_{GS(TH)}/T_J$ |   |              | 4.0 |     | mV/°C |            |
| Drain-to-Source On Resistance              | $R_{DS(on)}$     | $V_{GS} = 10$ V                         | $I_D = 30$ A |     | 0.9 | 1.2   | m $\Omega$ |
|  |                  |   | $I_D = 15$ A |     | 0.9 |       |            |
|  |                  | $V_{GS} = 4.5$ V                        | $I_D = 30$ A |     | 1.5 | 2.0   |            |
|  |                  |   | $I_D = 15$ A |     | 1.5 |       |            |
| Forward Transconductance                   | $g_{FS}$         | $V_{DS} = 1.5$ V, $I_D = 15$ A          |              | 82  |     | S     |            |

### CHARGES, CAPACITANCES & GATE RESISTANCE

|                              |              |   |  |       |  |    |
|------------------------------|--------------|---|--|-------|--|----|
| Input Capacitance            | $C_{ISS}$    | $V_{GS} = 0$ V, $f = 1$ MHz, $V_{DS} = 15$ V    |  | 10930 |  | pF |
| Output Capacitance           | $C_{OSS}$    |   |  | 3230  |  |    |
| Reverse Transfer Capacitance | $C_{RSS}$    |   |  | 92    |  |    |
| Total Gate Charge            | $Q_{G(TOT)}$ | $V_{GS} = 4.5$ V, $V_{DS} = 15$ V; $I_D = 30$ A |  | 62.1  |  | nC |
| Threshold Gate Charge        | $Q_{G(TH)}$  |   |  | 15.7  |  |    |
| Gate-to-Source Charge        | $Q_{GS}$     |   |  | 27    |  |    |
| Gate-to-Drain Charge         | $Q_{GD}$     |   |  | 10.1  |  |    |
| Total Gate Charge            | $Q_{G(TOT)}$ | $V_{GS} = 10$ V, $V_{DS} = 15$ V; $I_D = 30$ A  |  | 148   |  | nC |

### SWITCHING CHARACTERISTICS (Note 6)

|                     |              |  |  |    |  |    |
|---------------------|--------------|--|--|----|--|----|
| Turn-On Delay Time  | $t_{d(ON)}$  | $V_{GS} = 4.5$ V, $V_{DS} = 15$ V,<br>$I_D = 15$ A, $R_G = 3.0$ $\Omega$ |  | 31 |  | ns |
| Rise Time           | $t_r$        |  |  | 33 |  |    |
| Turn-Off Delay Time | $t_{d(OFF)}$ |  |  | 47 |  |    |
| Fall Time           | $t_f$        |  |  | 23 |  |    |

5. Pulse Test: pulse width  $\leq 300$   $\mu$ s, duty cycle  $\leq 2\%$ .

6. Switching characteristics are independent of operating junction temperatures.

# NTMFS4933N

## ELECTRICAL CHARACTERISTICS (T<sub>J</sub> = 25°C unless otherwise specified)

| Parameter                                 | Symbol              | Test Condition   | Min | Typ  | Max | Unit |
|---|---------------------|--|-----|------|-----|------|
| <b>SWITCHING CHARACTERISTICS</b> (Note 6) |                     |  |     |      |     |      |
| Turn-On Delay Time                        | t <sub>d(ON)</sub>  | V <sub>GS</sub> = 10 V, V <sub>DS</sub> = 15 V,<br>I <sub>D</sub> = 15 A, R <sub>G</sub> = 3.0 Ω |     | 20   |     | ns   |
| Rise Time                                 | t <sub>r</sub>      |  |     | 26   |     |      |
| Turn-Off Delay Time                       | t <sub>d(OFF)</sub> |  |     | 88.6 |     |      |
| Fall Time                                 | t <sub>f</sub>      |  |     | 22   |     |      |

## DRAIN-SOURCE DIODE CHARACTERISTICS

|                         |                 |   |                        |      |      |     |   |
|-------------------------|-----------------|---|------------------------|------|------|-----|---|
| Forward Diode Voltage   | V <sub>SD</sub> | V <sub>GS</sub> = 0 V,<br>I <sub>S</sub> = 30 A                                 | T <sub>J</sub> = 25°C  |      | 0.82 | 1.1 | V |
|                         |                 |   | T <sub>J</sub> = 125°C |      | 0.68 |     |   |
| Reverse Recovery Time   | t <sub>RR</sub> | V <sub>GS</sub> = 0 V, dI <sub>S</sub> /dt = 100 A/μs,<br>I <sub>S</sub> = 30 A |                        | 73.5 |      | ns  |   |
| Charge Time             | t <sub>a</sub>  |   |                        | 35.9 |      |     |   |
| Discharge Time          | t <sub>b</sub>  |   |                        | 37.6 |      |     |   |
| Reverse Recovery Charge | Q <sub>RR</sub> |   |                        | 117  |      | nC  |   |

## PACKAGE PARASITIC VALUES

|                   |                |                       |  |       |     |    |
|-------------------|----------------|-----------------------|--|-------|-----|----|
| Source Inductance | L <sub>S</sub> | T <sub>A</sub> = 25°C |  | 0.50  |     | nH |
| Drain Inductance  | L <sub>D</sub> |                       |  | 0.005 |     | nH |
| Gate Inductance   | L <sub>G</sub> |                       |  | 1.84  |     | nH |
| Gate Resistance   | R <sub>G</sub> |                       |  | 1.1   | 2.2 | Ω  |

5. Pulse Test: pulse width ≤ 300 μs, duty cycle ≤ 2%.
6. Switching characteristics are independent of operating junction temperatures.

TYPICAL CHARACTERISTICS

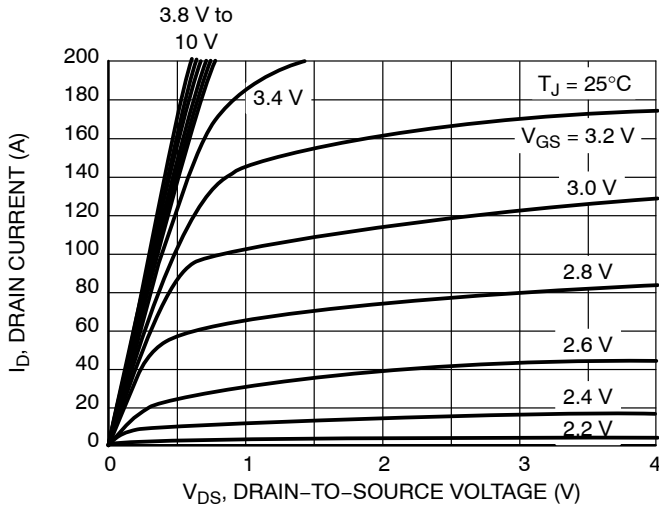

Figure 1. On-Region Characteristics

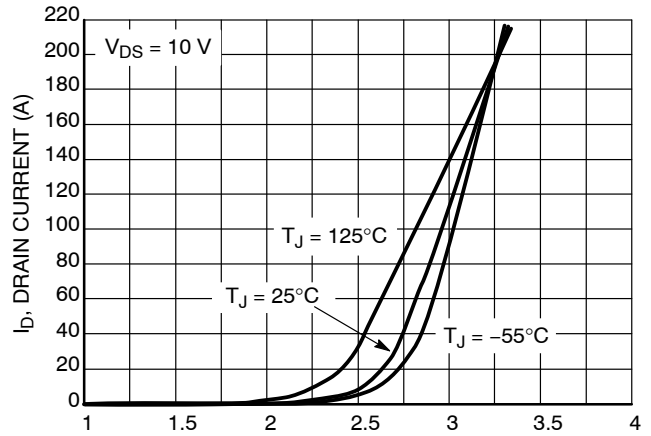

Figure 2. Transfer Characteristics

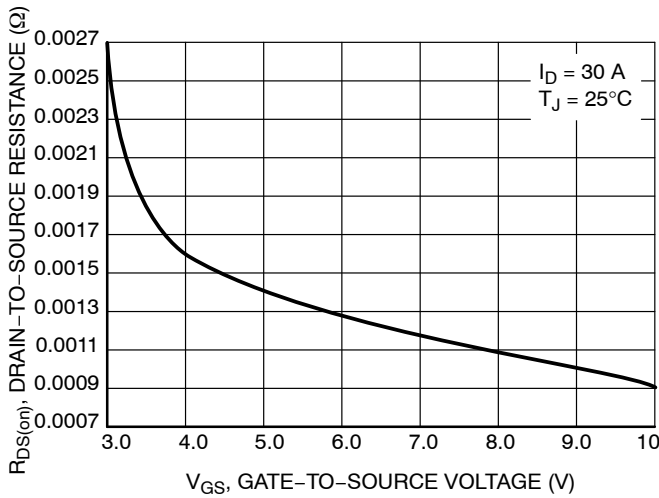

Figure 3. On-Resistance vs. Gate-to-Source Voltage

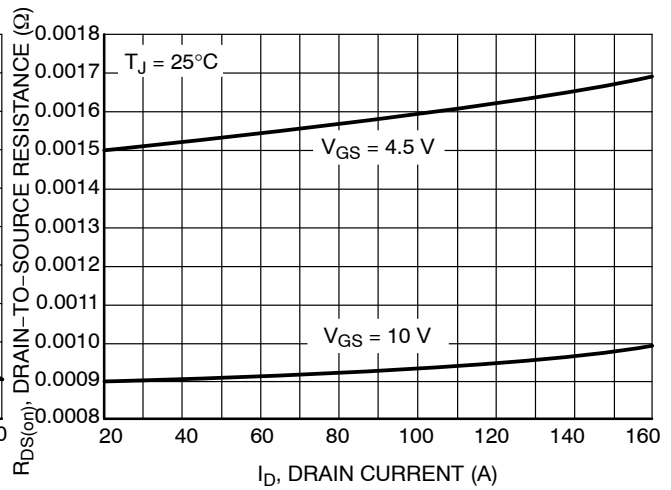

Figure 4. On-Resistance vs. Drain Current and Gate Voltage

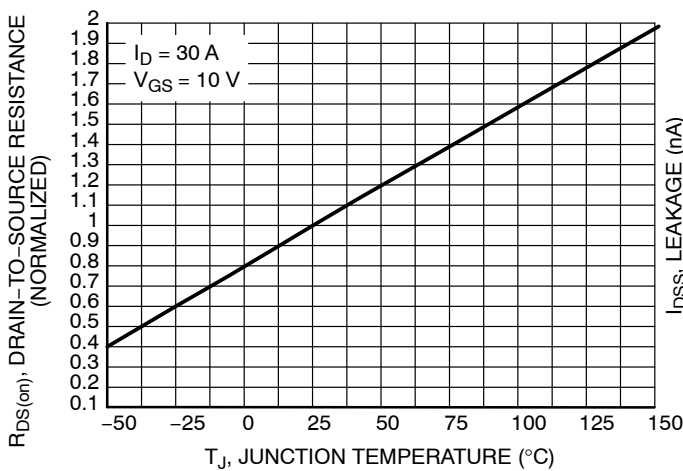

Figure 5. On-Resistance Variation with Temperature

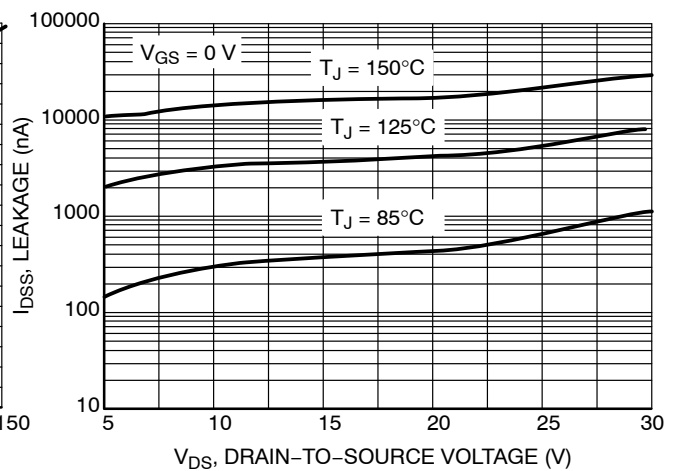

Figure 6. Drain-to-Source Leakage Current vs. Voltage

TYPICAL CHARACTERISTICS

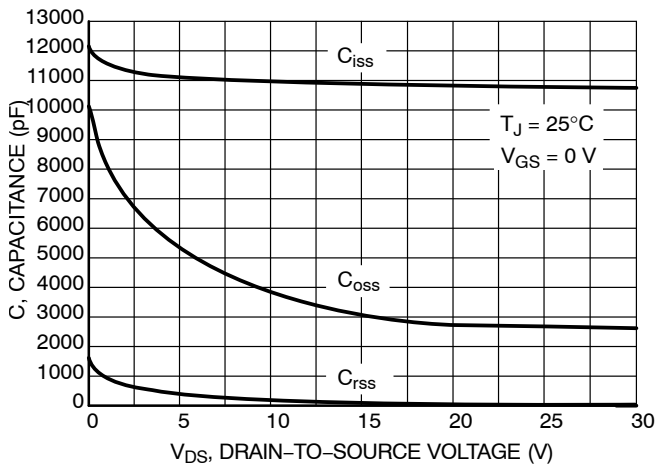

Figure 7. Capacitance Variation

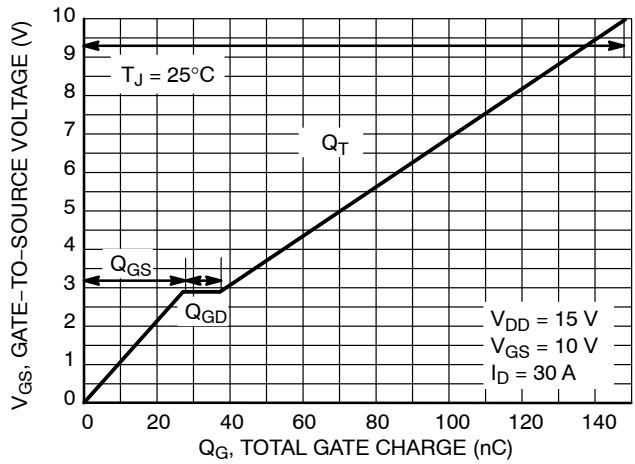

Figure 8. Gate-To-Source and Drain-To-Source Voltage vs. Total Charge

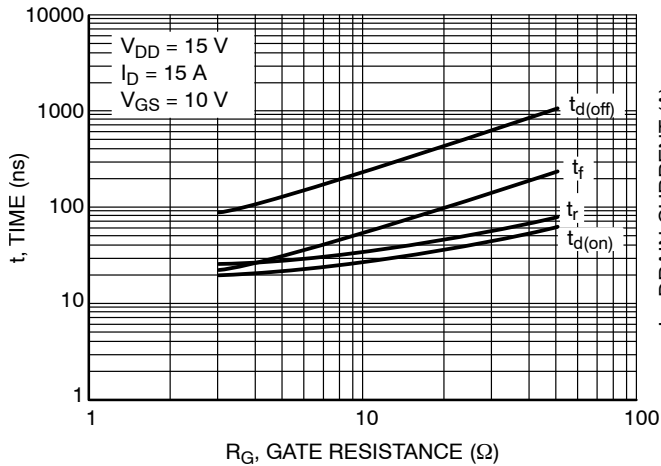

Figure 9. Resistive Switching Time Variation vs. Gate Resistance

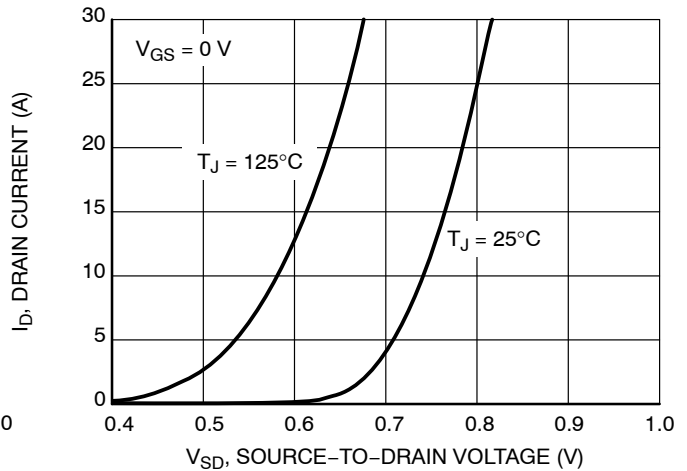

Figure 10. Diode Forward Voltage vs. Current

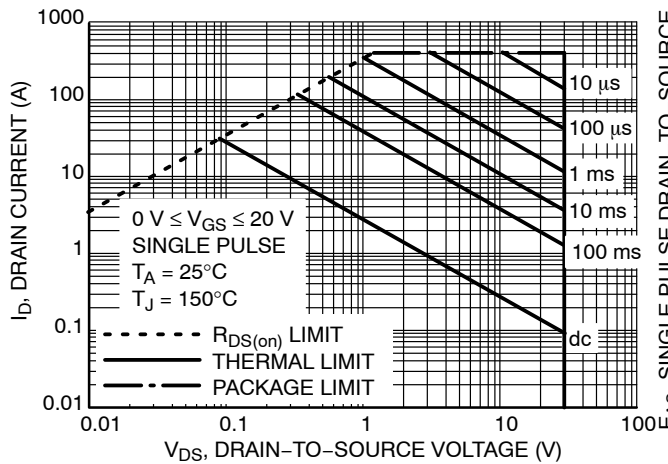

Figure 11. Maximum Rated Forward Biased Safe Operating Area

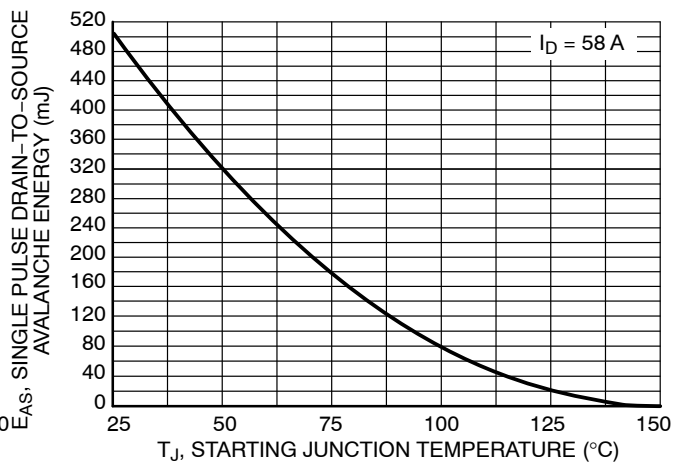

Figure 12. Maximum Avalanche Energy vs. Starting Junction Temperature

# NTMFS4933N

## TYPICAL CHARACTERISTICS

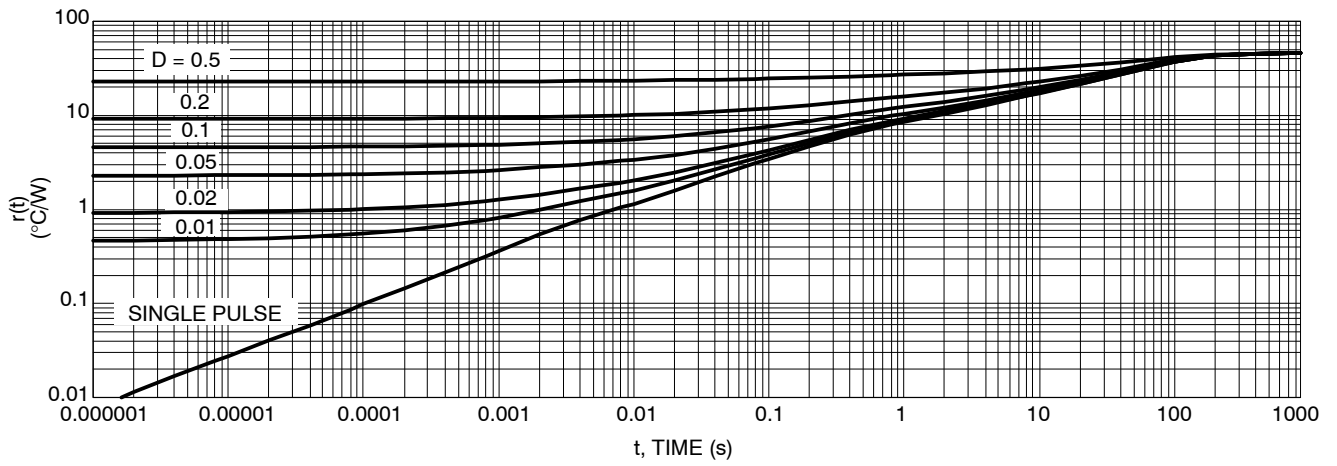

Figure 13. Thermal Response

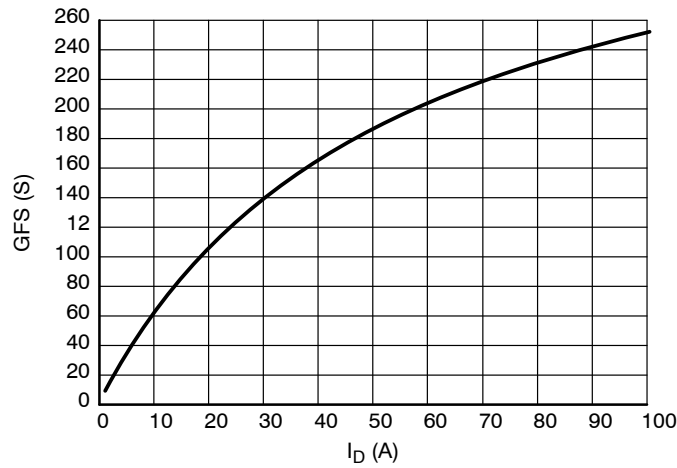
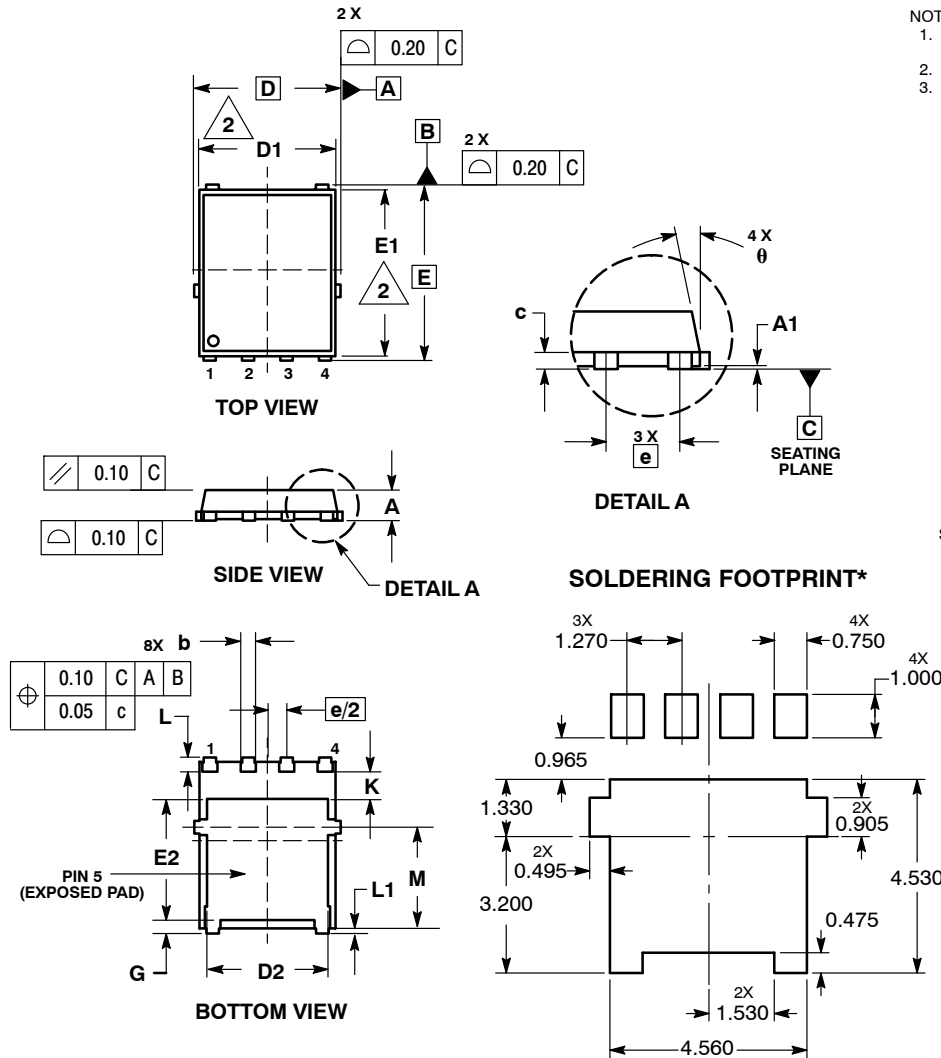

Figure 14. GFS vs.  $I_D$

# NTMFS4933N

## PACKAGE DIMENSIONS

DFN5 5x6, 1.27P  
(SO-8FL)  
CASE 488AA  
ISSUE G



- NOTES:
1. DIMENSIONING AND TOLERANCING PER ASME Y14.5M, 1994.
  2. CONTROLLING DIMENSION: MILLIMETER.
  3. DIMENSION D1 AND E1 DO NOT INCLUDE MOLD FLASH PROTRUSIONS OR GATE BURRS.

| DIM | MILLIMETERS |      |      |
|-----|-------------|------|------|
|     | MIN         | NOM  | MAX  |
| A   | 0.90        | 1.00 | 1.10 |
| A1  | 0.00        | ---  | 0.05 |
| b   | 0.33        | 0.41 | 0.51 |
| c   | 0.23        | 0.28 | 0.33 |
| D   | 5.15 BSC    |      |      |
| D1  | 4.50        | 4.90 | 5.10 |
| D2  | 3.50        | ---  | 4.22 |
| E   | 6.15 BSC    |      |      |
| E1  | 5.50        | 5.80 | 6.10 |
| E2  | 3.45        | ---  | 4.30 |
| e   | 1.27 BSC    |      |      |
| G   | 0.51        | 0.61 | 0.71 |
| K   | 1.20        | 1.35 | 1.50 |
| L   | 0.51        | 0.61 | 0.71 |
| L1  | 0.05        | 0.17 | 0.20 |
| M   | 3.00        | 3.40 | 3.80 |
| θ   | 0°          | ---  | 12°  |

- STYLE 1:  
PIN 1. SOURCE  
2. SOURCE  
3. SOURCE  
4. GATE  
5. DRAIN

\*For additional information on our Pb-Free strategy and soldering details, please download the ON Semiconductor Soldering and Mounting Techniques Reference Manual, SOLDERRM/D.

ON Semiconductor and are registered trademarks of Semiconductor Components Industries, LLC (SCILLC). SCILLC reserves the right to make changes without further notice to any products herein. SCILLC makes no warranty, representation or guarantee regarding the suitability of its products for any particular purpose, nor does SCILLC assume any liability arising out of the application or use of any product or circuit, and specifically disclaims any and all liability, including without limitation special, consequential or incidental damages. "Typical" parameters which may be provided in SCILLC data sheets and/or specifications can and do vary in different applications and actual performance may vary over time. All operating parameters, including "Typicals" must be validated for each customer application by customer's technical experts. SCILLC does not convey any license under its patent rights nor the rights of others. SCILLC products are not designed, intended, or authorized for use as components in systems intended for surgical implant into the body, or other applications intended to support or sustain life, or for any other application in which the failure of the SCILLC product could create a situation where personal injury or death may occur. Should Buyer purchase or use SCILLC products for any such unintended or unauthorized application, Buyer shall indemnify and hold SCILLC and its officers, employees, subsidiaries, affiliates, and distributors harmless against all claims, costs, damages, and expenses, and reasonable attorney fees arising out of, directly or indirectly, any claim of personal injury or death associated with such unintended or unauthorized use, even if such claim alleges that SCILLC was negligent regarding the design or manufacture of the part. SCILLC is an Equal Opportunity/Affirmative Action Employer. This literature is subject to all applicable copyright laws and is not for resale in any manner.

### PUBLICATION ORDERING INFORMATION

LITERATURE FULFILLMENT:  
Literature Distribution Center for ON Semiconductor  
P.O. Box 5163, Denver, Colorado 80217 USA  
Phone: 303-675-2175 or 800-344-3860 Toll Free USA/Canada  
Fax: 303-675-2176 or 800-344-3867 Toll Free USA/Canada  
Email: orderlit@onsemi.com

N. American Technical Support: 800-282-9855 Toll Free  
USA/Canada  
Europe, Middle East and Africa Technical Support:  
Phone: 421 33 790 2910  
Japan Customer Focus Center  
Phone: 81-3-5817-1050

ON Semiconductor Website: [www.onsemi.com](http://www.onsemi.com)  
Order Literature: <http://www.onsemi.com/orderlit>  
For additional information, please contact your local Sales Representative