

# NTMD4184PF

## Power MOSFET and Schottky Diode

-30 V, -4.0 A, Single P-Channel with 20 V, 2.2 A, Schottky Barrier Diode

### Features

- FETKY™ Surface Mount Package Saves Board Space
- Independent Pin-Out for MOSFET and Schottky Allowing for Design Flexibility
- Low  $R_{DS(on)}$  MOSFET and Low  $V_F$  Schottky to Minimize Conduction Losses
- Optimized Gate Charge to Minimize Switching Losses
- This is a Pb-Free Device

### Applications

- Disk Drives
- DC-DC Converters
- Printers

### MOSFET MAXIMUM RATINGS ( $T_J = 25^\circ\text{C}$ unless otherwise stated)

Rating	Symbol	Value	Unit	
Drain-to-Source Voltage	$V_{DSS}$	-30	V	
Gate-to-Source Voltage	$V_{GS}$	$\pm 20$	V	
Continuous Drain Current $R_{\theta JA}$ (Note 1)	$I_D$	$T_A = 25^\circ\text{C}$	-3.3	A
		$T_A = 70^\circ\text{C}$	-2.6	
Power Dissipation $R_{\theta JA}$ (Note 1)	$P_D$	1.6	W	
Continuous Drain Current $R_{\theta JA}$ (Note 2)	$I_D$	$T_A = 25^\circ\text{C}$	-2.3	A
		$T_A = 70^\circ\text{C}$	-1.8	
Power Dissipation $R_{\theta JA}$ (Note 2)	$P_D$	0.77	W	
Continuous Drain Current $R_{\theta JA} t < 10$ s (Note 1)	$I_D$	$T_A = 25^\circ\text{C}$	-4.0	A
		$T_A = 70^\circ\text{C}$	-3.2	
Power Dissipation $R_{\theta JA} t < 10$ s (Note 1)	$P_D$	2.31	W	
Pulsed Drain Current	$I_{DM}$	-10	A	
$T_A = 25^\circ\text{C}, t_p = 10 \mu\text{s}$				
Operating Junction and Storage Temperature	$T_J, T_{STG}$	-55 to +150	$^\circ\text{C}$	
Source Current (Body Diode)	$I_S$	-1.3	A	
Lead Temperature for Soldering Purposes (1/8" from case for 10 s)	$T_L$	260	$^\circ\text{C}$	

### SCHOTTKY MAXIMUM RATINGS ( $T_J = 25^\circ\text{C}$ unless otherwise stated)

Peak Repetitive Reverse Voltage	$V_{RRM}$	20	V	
DC Blocking Voltage	$V_R$	20	V	
Average Rectified Forward Current, (Note 1)	Steady State	$I_F$	2.2	A
	$t < 10$ s		3.2	



ON Semiconductor®

<http://onsemi.com>

### P-CHANNEL MOSFET

$V_{(BR)DSS}$	$R_{DS(on)}$ Max	$I_D$ Max
-30 V	95 m $\Omega$ @ -10 V	-4.0 A
	165 m $\Omega$ @ -4.5 V	

### SCHOTTKY DIODE

$V_R$ Max	$V_F$ Max	$I_F$ Max
20 V	0.58 V	2.2 A

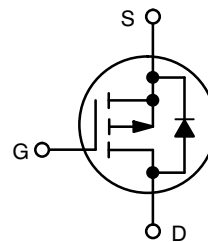

P-Channel MOSFET



Schottky Diode

### MARKING DIAGRAM & PIN ASSIGNMENT

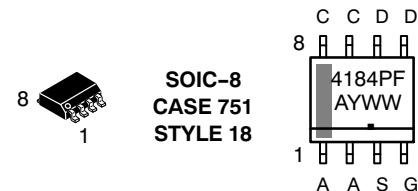

4184PF = Device Code  
 A = Assembly Location  
 Y = Year  
 WW = Work Week  
 ■ = Pb-Free Package

### ORDERING INFORMATION

Device	Package	Shipping†
NTMD4184PFR2G	SOIC-8 (Pb-Free)	2500/Tape & Reel

†For information on tape and reel specifications, including part orientation and tape sizes, please refer to our Tape and Reel Packaging Specification Brochure, BRD8011/D.

# NTMD4184PF

## THERMAL RESISTANCE MAXIMUM RATINGS

Parameter MOSFET & Schottky	Symbol	Max	Unit
Junction-to-Ambient – Steady State (Note 1)	$R_{\theta JA}$	79	°C/W
Junction-to-Ambient – $t \leq 10$ s Steady State (Note 1)	$R_{\theta JA}$	54	
Junction-to-FOOT (Drain) Equivalent to $R_{\theta JC}$	$R_{\theta JF}$	50	
Junction-to-Ambient – Steady State (Note 2)	$R_{\theta JA}$	163	

1. Surface-mounted on FR4 board using 1 inch sq pad size, 1 oz Cu.
2. Surface-mounted on FR4 board using the minimum recommended pad size.

## ELECTRICAL CHARACTERISTICS ( $T_J = 25^\circ\text{C}$ unless otherwise noted)

Characteristic	Symbol	Test Condition	Min	Typ	Max	Unit
----------------	--------	----------------	-----	-----	-----	------

### OFF CHARACTERISTICS

Drain-to-Source Breakdown Voltage	$V_{(BR)DSS}$	$V_{GS} = 0\text{ V}, I_D = 250\ \mu\text{A}$	-30			V
Drain-to-Source Breakdown Voltage Temperature Coefficient	$V_{(BR)DSS}/T_J$			30		mV/°C
Zero Gate Voltage Drain Current	$I_{DSS}$	$V_{GS} = 0\text{ V}, V_{DS} = -24\text{ V}$			-1.0	$\mu\text{A}$
		$T_J = 125^\circ\text{C}$			-10	
Gate-to-Source Leakage Current	$I_{GSS}$	$V_{DS} = 0\text{ V}, V_{GS} = \pm 20\text{ V}$			$\pm 100$	nA

### ON CHARACTERISTICS (Note 3)

Gate Threshold Voltage	$V_{GS(TH)}$	$V_{GS} = V_{DS}, I_D = 250\ \mu\text{A}$	-1.0		-3.0	V
Negative Threshold Temperature Coefficient	$V_{GS(TH)}/T_J$			4.4		mV/°C
Drain-to-Source On Resistance	$R_{DS(on)}$	$V_{GS} = -10\text{ V}, I_D = -3.0\text{ A}$ $V_{GS} = -4.5\text{ V}, I_D = -1.5\text{ A}$		70	95	m $\Omega$
				120	165	
Forward Transconductance	$g_{FS}$	$V_{DS} = -1.5\text{ V}, I_D = -3.0\text{ A}$		5.0		S

### CHARGES, CAPACITANCES AND GATE RESISTANCE

Input Capacitance	$C_{ISS}$	$V_{GS} = 0\text{ V}, f = 1.0\text{ MHz}, V_{DS} = -10\text{ V}$		280	360	pF
Output Capacitance	$C_{OSS}$			80	110	
Reverse Transfer Capacitance	$C_{RSS}$			52	80	
Total Gate Charge	$Q_{G(TOT)}$	$V_{GS} = -4.5\text{ V}, V_{DS} = -10\text{ V}, I_D = -3.0\text{ A}$		2.8	4.2	nC
Threshold Gate Charge	$Q_{G(TH)}$			0.4		
Gate-to-Source Charge	$Q_{GS}$			1.1		
Gate-to-Drain Charge	$Q_{GD}$			1.1		
Total Gate Charge	$Q_{G(TOT)}$	$V_{GS} = -10\text{ V}, V_{DS} = -10\text{ V}, I_D = -3.0\text{ A}$		5.8	8.8	nC

### SWITCHING CHARACTERISTICS (Note 4)

Turn-On Delay Time	$t_{d(ON)}$	$V_{GS} = -10\text{ V}, V_{DS} = -10\text{ V}, I_D = -1.0\text{ A}, R_G = 6.0\ \Omega$		7.2	15	ns
Rise Time	$t_r$			12	24	
Turn-Off Delay Time	$t_{d(OFF)}$			18	36	
Fall Time	$t_f$			2.6	6.0	

### DRAIN-TO-SOURCE CHARACTERISTICS

Forward Diode Voltage	$V_{SD}$	$V_{GS} = 0\text{ V}, I_D = -1.3\text{ A}$	$T_J = 25^\circ\text{C}$		-0.8	-1.0	V
			$T_J = 125^\circ\text{C}$		0.7		ns
Reverse Recovery Time	$t_{RR}$	$V_{GS} = 0\text{ V}, d_{IS}/d_t = 100\text{ A}/\mu\text{s}, I_S = -1.3\text{ A}$			12.8		
Charge Time	$t_a$				10		
Discharge Time	$t_b$				2.8		
Reverse Recovery Time	$Q_{RR}$				7.4		nC

# NTMD4184PF

## ELECTRICAL CHARACTERISTICS ( $T_J = 25^\circ\text{C}$ unless otherwise noted)

Characteristic	Symbol	Test Condition	Min	Typ	Max	Unit
----------------	--------	----------------	-----	-----	-----	------

## SCHOTTKY DIODE ELECTRICAL CHARACTERISTICS ( $T_J = 25^\circ\text{C}$ unless otherwise noted)

Parameter	Symbol	Test Conditions	Min	Typ	Max	Unit	
Maximum Instantaneous Forward Voltage	$V_F$	$I_F = 1.0\text{ A}$	$T_J = 25^\circ\text{C}$		0.43	0.50	V
			$T_J = 125^\circ\text{C}$		0.35	0.39	
		$I_F = 2.0\text{ A}$	$T_J = 25^\circ\text{C}$		0.5	0.58	
			$T_J = 125^\circ\text{C}$		0.45	0.53	
Maximum Instantaneous Reverse Current	$I_R$	$V_R = 10\text{ V}$	$T_J = 25^\circ\text{C}$		0.001	0.02	mA
			$T_J = 125^\circ\text{C}$		1.2	14	
		$V_R = 20\text{ V}$	$T_J = 25^\circ\text{C}$		0.004	0.05	
			$T_J = 125^\circ\text{C}$		2.0	18	

- Pulse Test: pulse width  $\leq 300\ \mu\text{s}$ , duty cycle  $\leq 2\%$ .
- Switching characteristics are independent of operating junction temperatures.

## TYPICAL CHARACTERISTICS

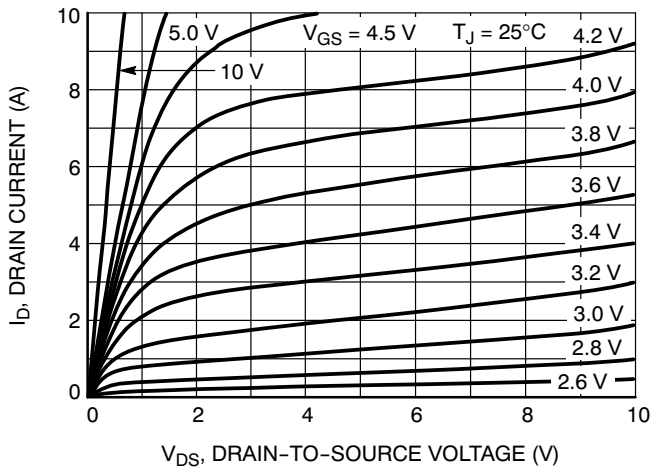

Figure 1. On-Region Characteristics

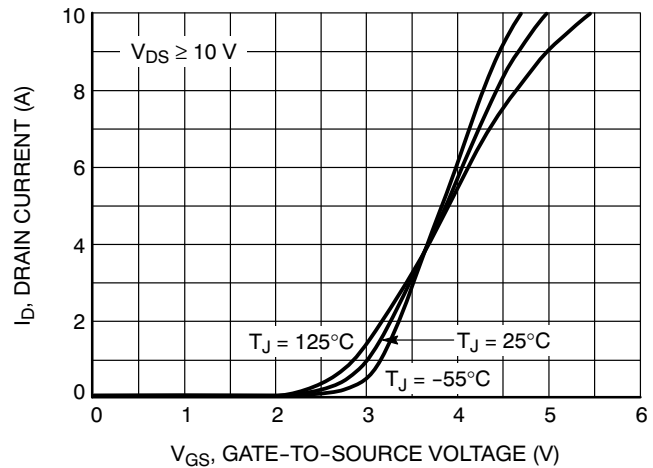

Figure 2. Transfer Characteristics

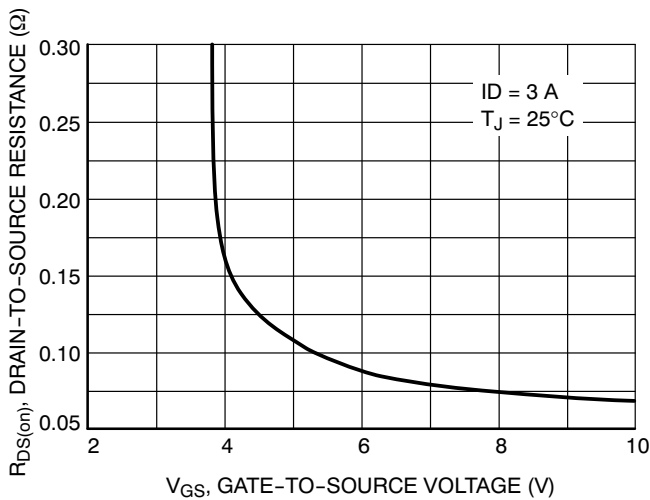

Figure 3. On-Resistance vs. Gate Voltage

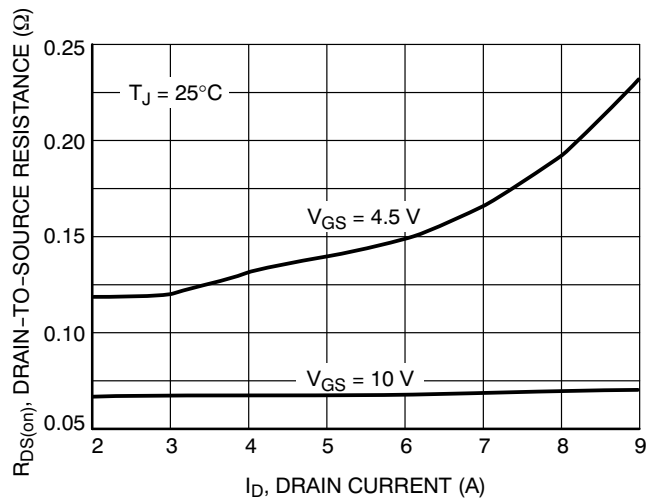

Figure 4. On-Resistance vs. Drain Current and Gate Voltage

TYPICAL CHARACTERISTICS

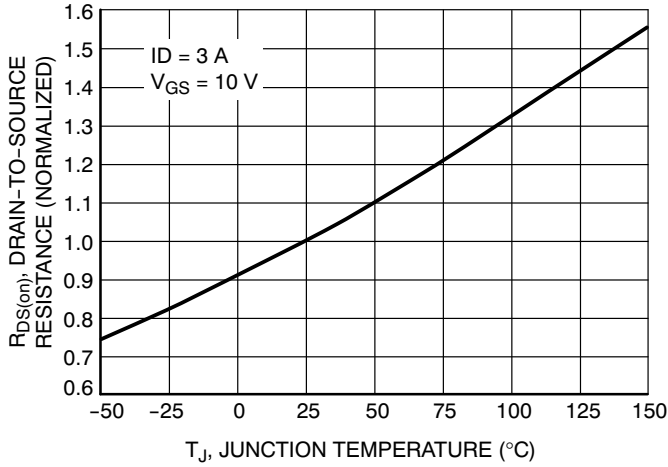

Figure 5. On-Resistance Variation with Temperature

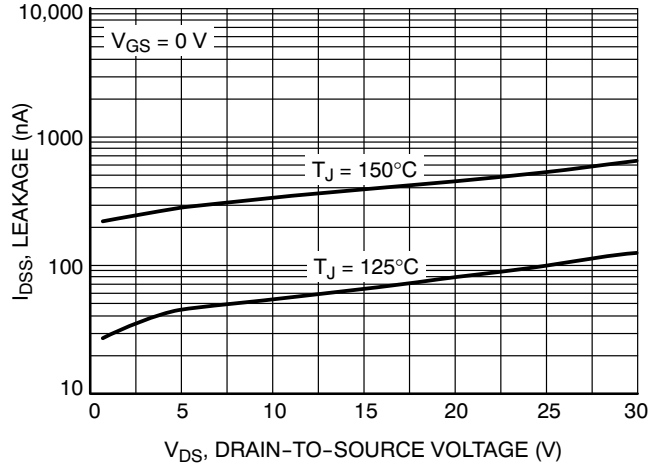

Figure 6. Drain-to-Source Leakage Current vs. Voltage

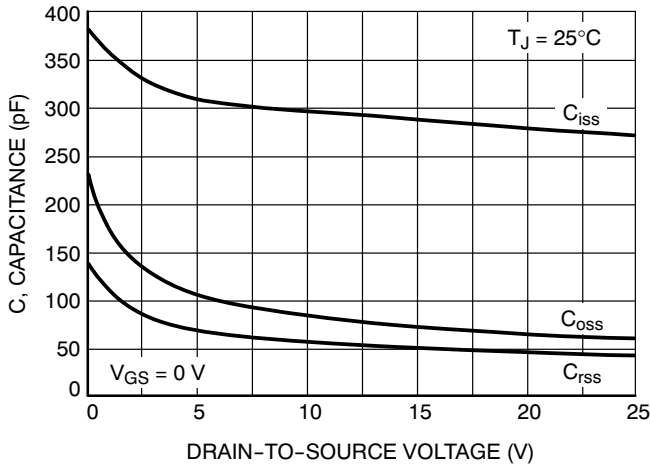

Figure 7. Capacitance Variation

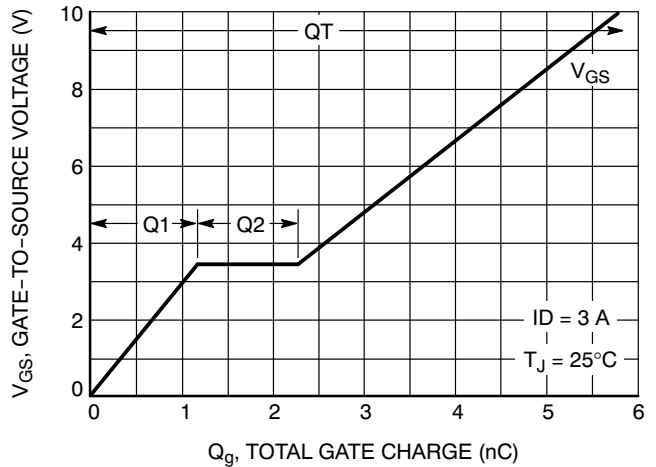

Figure 8. Gate-to-Source and Drain-to-Source Voltage vs. Total Charge

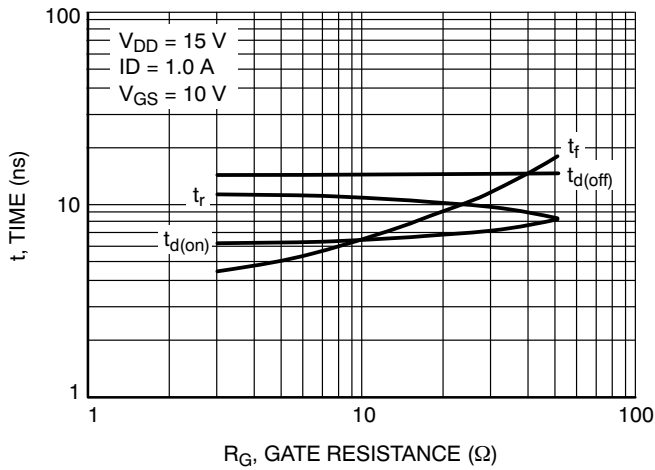

Figure 9. Resistive Switching Time Variation vs. Gate Resistance

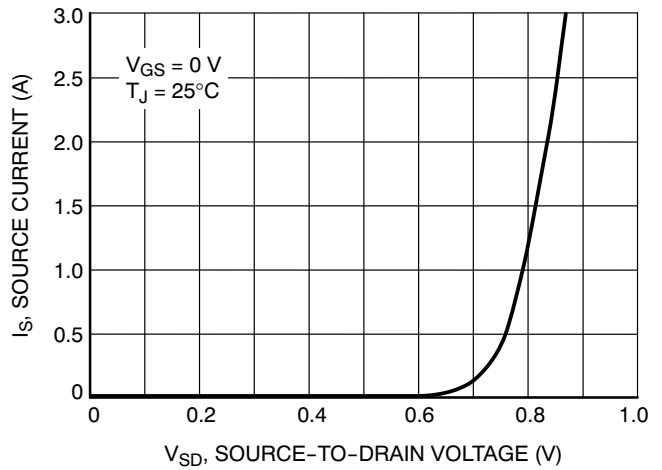

Figure 10. Diode Forward Voltage vs. Current

# NTMD4184PF

## TYPICAL CHARACTERISTICS

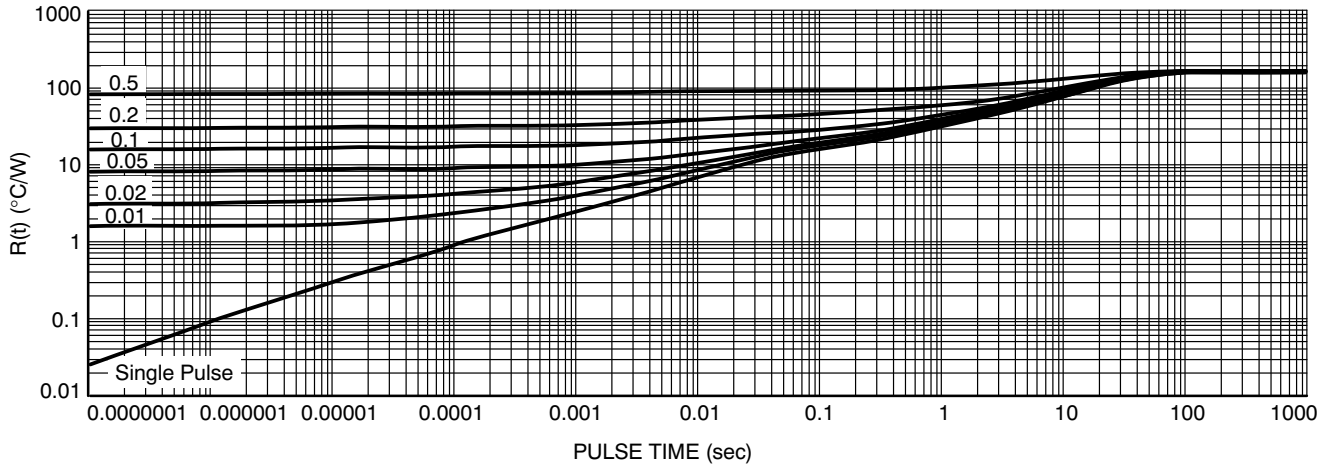

Figure 11. Thermal Response -  $R_{\theta JA}$  at Steady State (min pad)

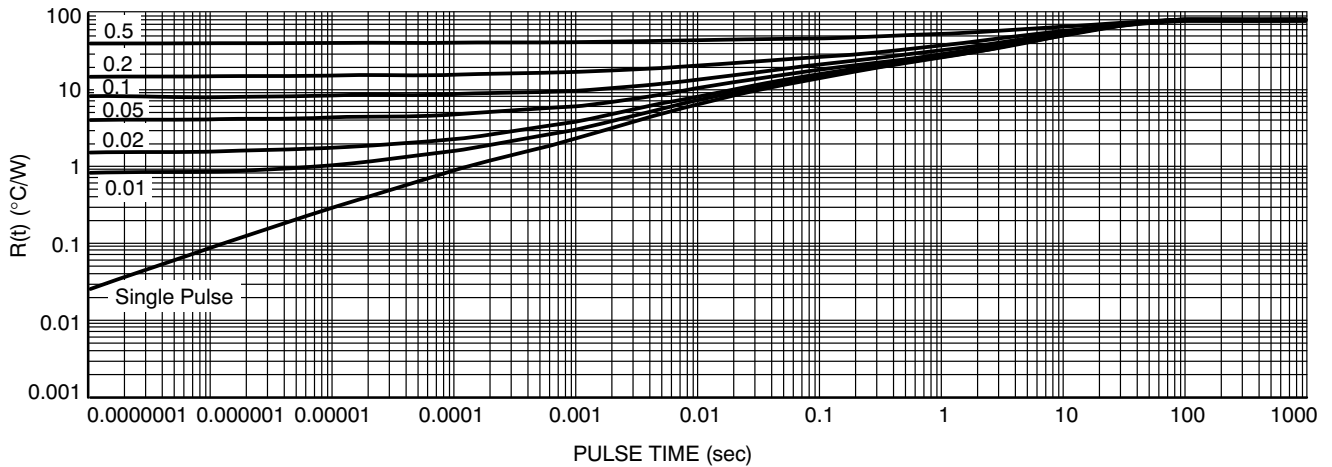

Figure 12. Thermal Response -  $R_{\theta JA}$  at Steady State (1 inch sq pad)

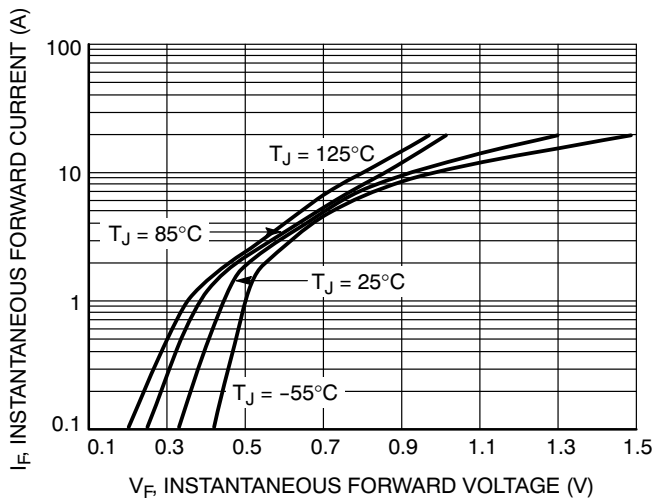

Figure 13. Typical Forward Voltage

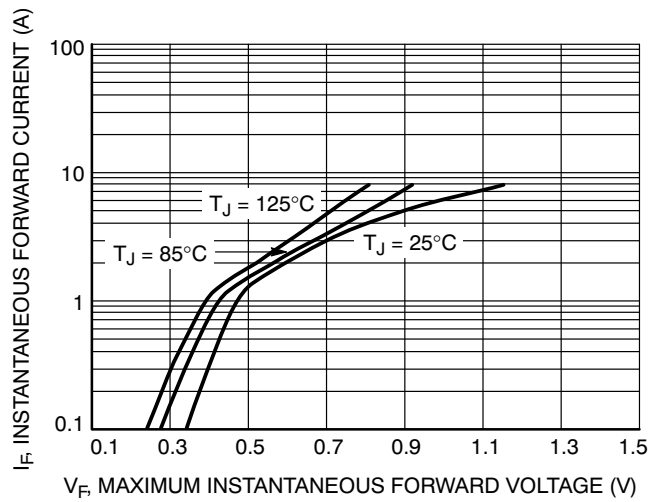

Figure 14. Maximum Forward Voltage

# NTMD4184PF

## TYPICAL CHARACTERISTICS

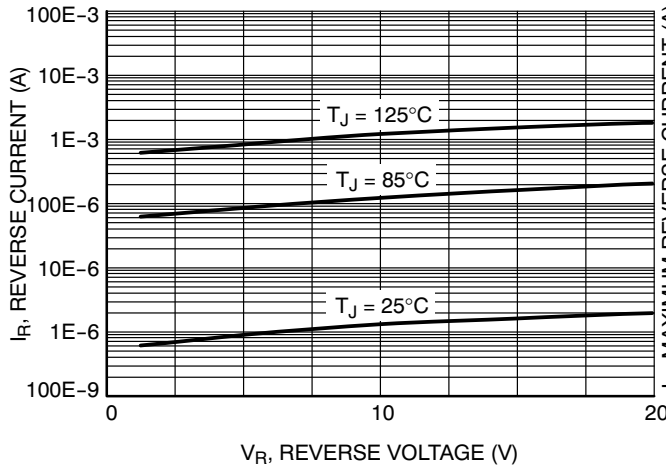

Figure 15. Typical Reverse Current

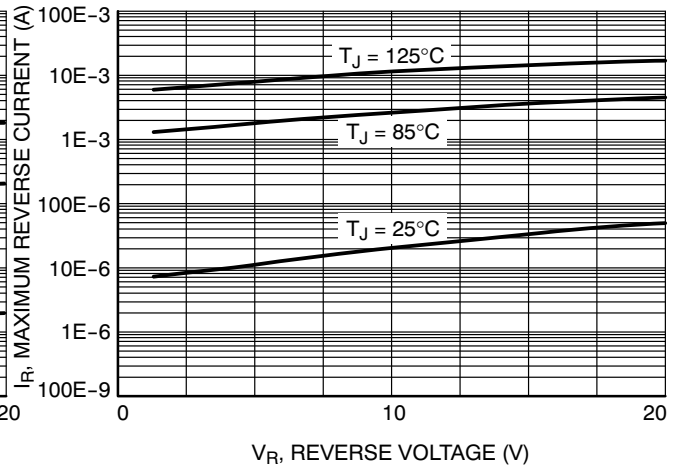

Figure 16. Maximum Reverse Current

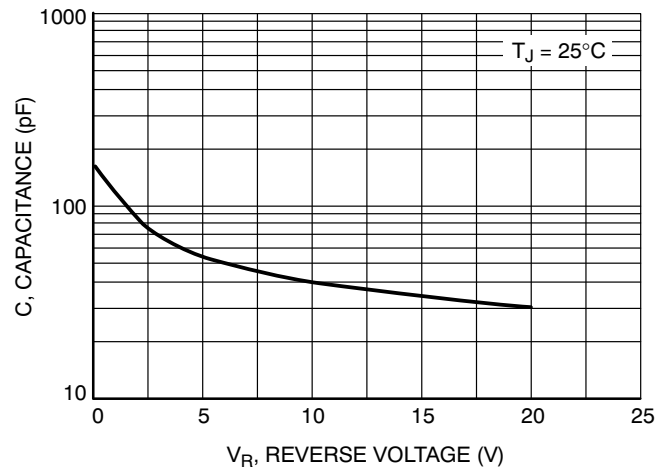
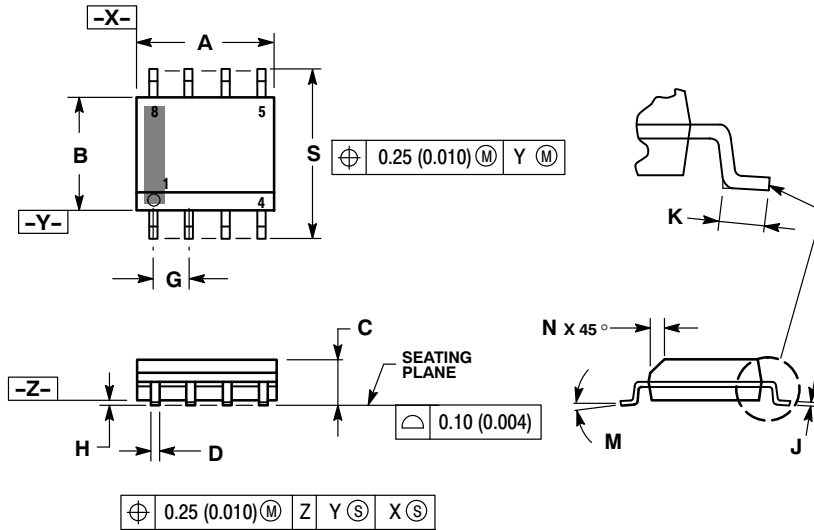

Figure 17. Capacitance

# NTMD4184PF

## PACKAGE DIMENSIONS

### SOIC-8 NB CASE 751-07 ISSUE AH



#### NOTES:

1. DIMENSIONING AND TOLERANCING PER ANSI Y14.5M, 1982.
2. CONTROLLING DIMENSION: MILLIMETER.
3. DIMENSION A AND B DO NOT INCLUDE MOLD PROTRUSION.
4. MAXIMUM MOLD PROTRUSION 0.15 (0.006) PER SIDE.
5. DIMENSION D DOES NOT INCLUDE DAMBAR PROTRUSION. ALLOWABLE DAMBAR PROTRUSION SHALL BE 0.127 (0.005) TOTAL IN EXCESS OF THE D DIMENSION AT MAXIMUM MATERIAL CONDITION.
6. 751-01 THRU 751-06 ARE OBSOLETE. NEW STANDARD IS 751-07.

DIM	MILLIMETERS		INCHES	
	MIN	MAX	MIN	MAX
A	4.80	5.00	0.189	0.197
B	3.80	4.00	0.150	0.157
C	1.35	1.75	0.053	0.069
D	0.33	0.51	0.013	0.020
G	1.27 BSC		0.050 BSC	
H	0.10	0.25	0.004	0.010
J	0.19	0.25	0.007	0.010
K	0.40	1.27	0.016	0.050
M	0°	8°	0°	8°
N	0.25	0.50	0.010	0.020
S	5.80	6.20	0.228	0.244

### SOLDERING FOOTPRINT\*

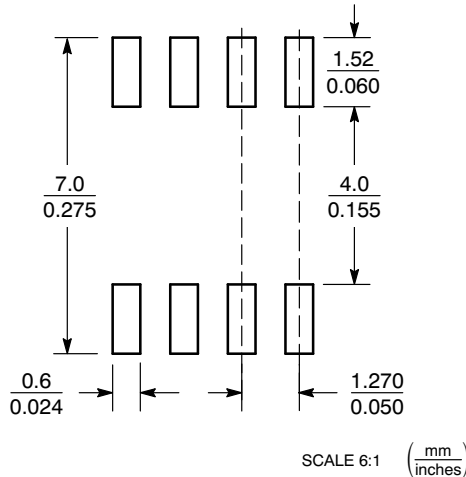

#### STYLE 18:

- PIN 1. ANODE
- ANODE
- SOURCE
- GATE
- DRAIN
- DRAIN
- CATHODE
- CATHODE

\*For additional information on our Pb-Free strategy and soldering details, please download the ON Semiconductor Soldering and Mounting Techniques Reference Manual, SOLDERRM/D.

FETKY and Micro8 are registered trademarks of International Rectifier Corporation.

ON Semiconductor and are registered trademarks of Semiconductor Components Industries, LLC (SCILLC). SCILLC reserves the right to make changes without further notice to any products herein. SCILLC makes no warranty, representation or guarantee regarding the suitability of its products for any particular purpose, nor does SCILLC assume any liability arising out of the application or use of any product or circuit, and specifically disclaims any and all liability, including without limitation special, consequential or incidental damages. "Typical" parameters which may be provided in SCILLC data sheets and/or specifications can and do vary in different applications and actual performance may vary over time. All operating parameters, including "Typicals" must be validated for each customer application by customer's technical experts. SCILLC does not convey any license under its patent rights nor the rights of others. SCILLC products are not designed, intended, or authorized for use as components in systems intended for surgical implant into the body, or other applications intended to support or sustain life, or for any other application in which the failure of the SCILLC product could create a situation where personal injury or death may occur. Should Buyer purchase or use SCILLC products for any such unintended or unauthorized application, Buyer shall indemnify and hold SCILLC and its officers, employees, subsidiaries, affiliates, and distributors harmless against all claims, costs, damages, and expenses, and reasonable attorney fees arising out of, directly or indirectly, any claim of personal injury or death associated with such unintended or unauthorized use, even if such claim alleges that SCILLC was negligent regarding the design or manufacture of the part. SCILLC is an Equal Opportunity/Affirmative Action Employer. This literature is subject to all applicable copyright laws and is not for resale in any manner.

### PUBLICATION ORDERING INFORMATION

**LITERATURE FULFILLMENT:**  
Literature Distribution Center for ON Semiconductor  
P.O. Box 5163, Denver, Colorado 80217 USA  
**Phone:** 303-675-2175 or 800-344-3860 Toll Free USA/Canada  
**Fax:** 303-675-2176 or 800-344-3867 Toll Free USA/Canada  
**Email:** orderlit@onsemi.com

**N. American Technical Support:** 800-282-9855 Toll Free  
USA/Canada

**Japan:** ON Semiconductor, Japan Customer Focus Center  
2-9-1 Kamimeguro, Meguro-ku, Tokyo, Japan 153-0051  
**Phone:** 81-3-5773-3850

**ON Semiconductor Website:** <http://onsemi.com>

**Order Literature:** <http://www.onsemi.com/litorder>

For additional information, please contact your local Sales Representative.