

# MBRAF440, NRVBAF440

## Surface Mount Schottky Power Rectifier

This device employs the Schottky Barrier principle in a large area metal-to-silicon power diode. State-of-the-art geometry features epitaxial construction with oxide passivation and metal overlay contact. Ideally suited for low voltage, high frequency rectification, or as free wheeling and polarity protection diodes in surface mount applications where compact size and weight are critical to the system.

### Features

- Low Profile Package for Space Constrained Applications
- Rectangular Package for Automated Handling
- Highly Stable Oxide Passivated Junction
- 150°C Operating Junction Temperature
- Guard-Ring for Stress Protection
- NRV Prefix for Automotive and Other Applications Requiring Unique Site and Control Change Requirements; AEC-Q101 Qualified and PPAP Capable
- These are Pb-Free and Halide-Free Devices

### Mechanical Characteristics

- Case: Epoxy, Molded, Epoxy Meets UL 94, V-0
- Weight: 95 mg (approximately)
- Finish: All External Surfaces Corrosion Resistant and Terminal Leads are Readily Solderable
- Lead and Mounting Surface Temperature for Soldering Purposes: 260°C Max. for 10 Seconds
- Cathode Polarity Band
- Device Meets MSL 1 Requirements



**ON Semiconductor®**

[www.onsemi.com](http://www.onsemi.com)

**SCHOTTKY BARRIER  
RECTIFIER  
4.0 AMPERE  
40 VOLTS**

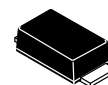

**SMA-FL  
CASE 403AA  
STYLE 6**

### MARKING DIAGRAM



RAF = Specific Device Code  
A = Assembly Location  
Y = Year  
WW = Work Week  
▪ = Pb-Free Package

### ORDERING INFORMATION

Device	Package	Shipping†
MBRAF440T3G	SMA-FL (Pb-Free)	5000 / Tape & Reel
NRVBAF440T3G	SMA-FL (Pb-Free)	5000 / Tape & Reel

†For information on tape and reel specifications, including part orientation and tape sizes, please refer to our Tape and Reel Packaging Specification Brochure, BRD8011/D.

# MBRAF440, NRVBAF440

## MAXIMUM RATINGS

Rating	Symbol	Value	Unit
Peak Repetitive Reverse Voltage Working Peak Reverse Voltage DC Blocking Voltage	$V_{RRM}$ $V_{RWM}$ $V_R$	40	V
Average Rectified Forward Current (At Rated $V_R$ , $T_L = 107^\circ\text{C}$ )	$I_O$	4.0	A
Non-Repetitive Peak Surge Current (Surge Applied at Rated Load Conditions Halfwave, Single Phase, 60 Hz)	$I_{FSM}$	100	A
Storage/Operating Case Temperature	$T_{stg}$ , $T_C$	-55 to +150	$^\circ\text{C}$
Operating Junction Temperature (Note 1)	$T_J$	-55 to +150	$^\circ\text{C}$
Voltage Rate of Change (Rated $V_R$ , $T_J = 25^\circ\text{C}$ )	dv/dt	10,000	V/ $\mu\text{s}$
ESD Rating	Human Body Model Machine Model	$ESD_{HBM}$ $ESD_{MM}$	3B M4 -

Stresses exceeding those listed in the Maximum Ratings table may damage the device. If any of these limits are exceeded, device functionality should not be assumed, damage may occur and reliability may be affected.

1. The heat generated must be less than the thermal conductivity from Junction-to-Ambient:  $dP_D/dT_J < 1/R_{\theta JA}$ .

## THERMAL CHARACTERISTICS

Characteristic	Symbol	Value	Unit
Thermal Resistance – Junction-to-Lead (Note 2)	$R_{\theta JL}$	25	$^\circ\text{C}/\text{W}$
Thermal Resistance – Junction-to-Ambient (Note 2)	$R_{\theta JA}$	90	

2. 1 inch square pad size (1 × 0.5 inch) for each lead on FR4 board.

## ELECTRICAL CHARACTERISTICS

Characteristic	Symbol	Value		Unit
		$T_J = 25^\circ\text{C}$	$T_J = 100^\circ\text{C}$	
Maximum Instantaneous Forward Voltage (Note 3) ( $I_F = 4.0\text{ A}$ )	$V_F$	0.485	0.435	V
Maximum Instantaneous Reverse Current ( $V_R = 40\text{ V}$ )	$I_R$	0.3	15	mA

Product parametric performance is indicated in the Electrical Characteristics for the listed test conditions, unless otherwise noted. Product performance may not be indicated by the Electrical Characteristics if operated under different conditions.

3. Pulse Test: Pulse Width  $\leq 250\ \mu\text{s}$ , Duty Cycle  $\leq 2.0\%$ .

# MBRAF440, NRVBAF440

## TYPICAL CHARACTERISTICS

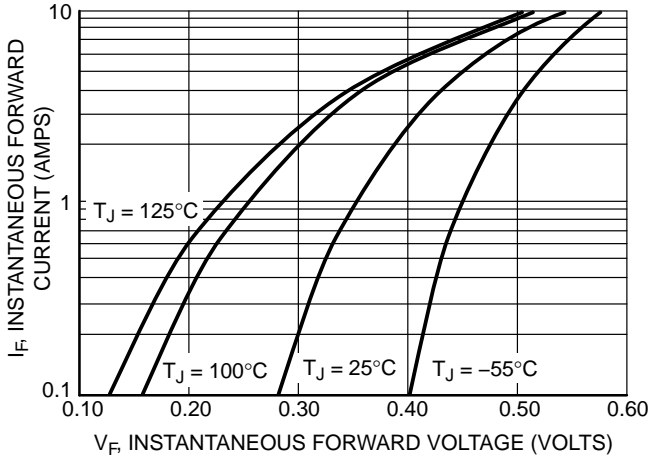

Figure 1. Typical Forward Voltage

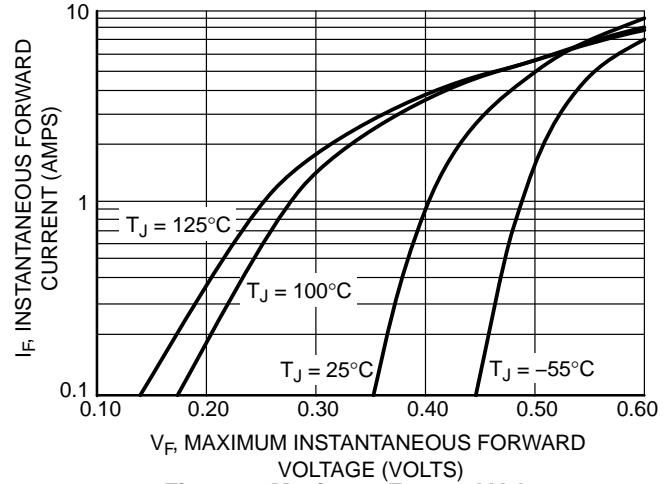

Figure 2. Maximum Forward Voltage

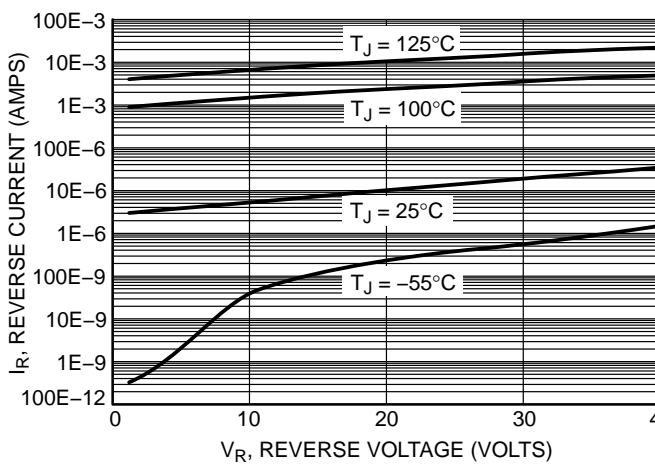

Figure 3. Typical Reverse Current

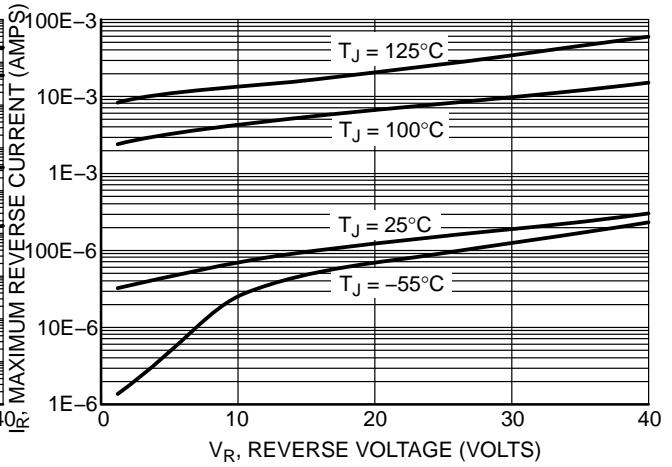

Figure 4. Maximum Reverse Current

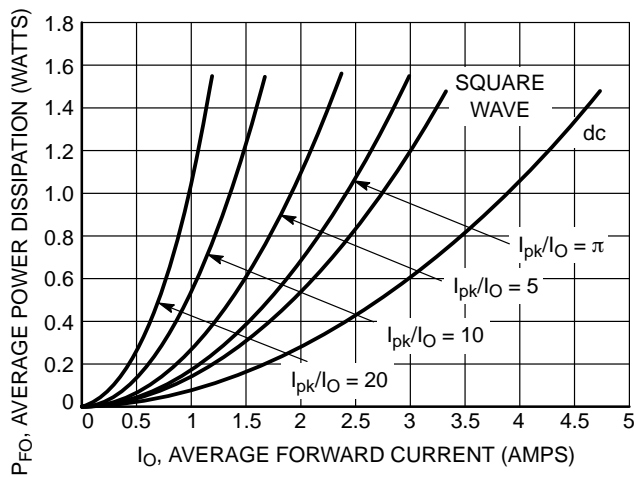

Figure 5. Forward Power Dissipation

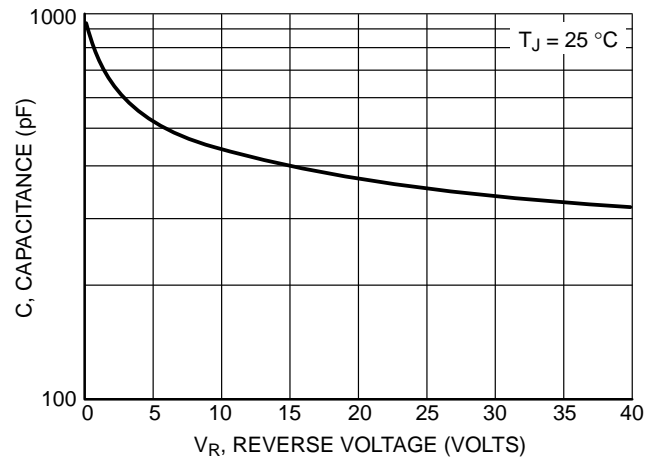

Figure 6. Capacitance

# MBRAF440, NRVBAF440

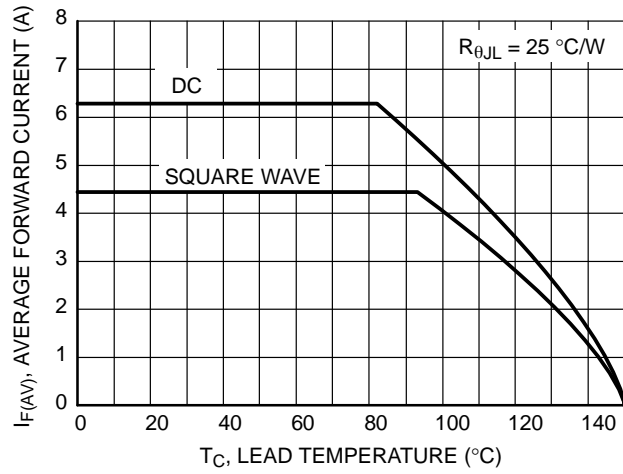

Figure 7. Current Derating

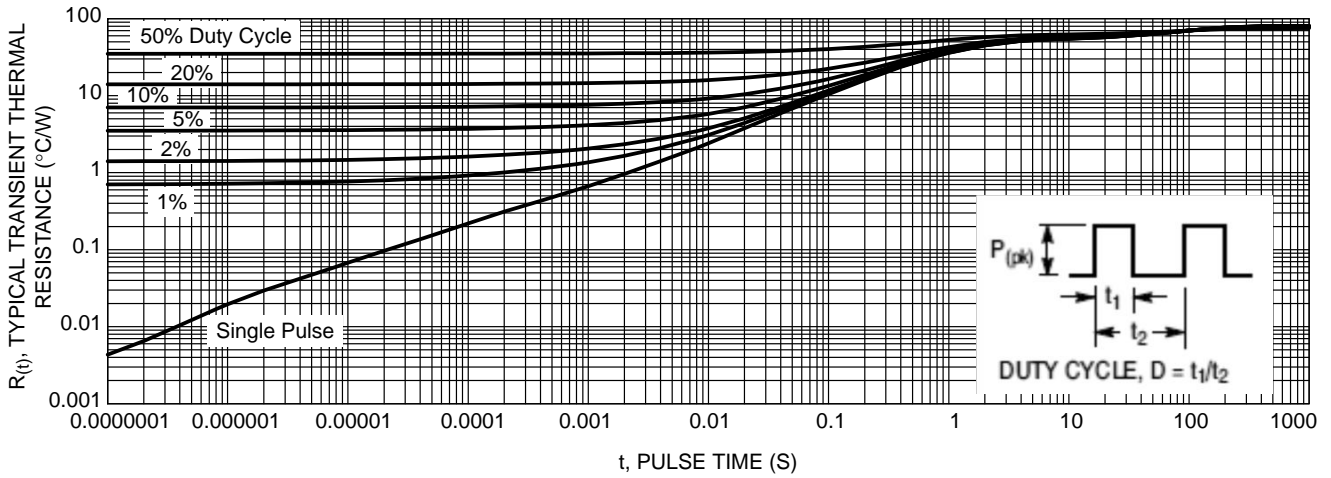
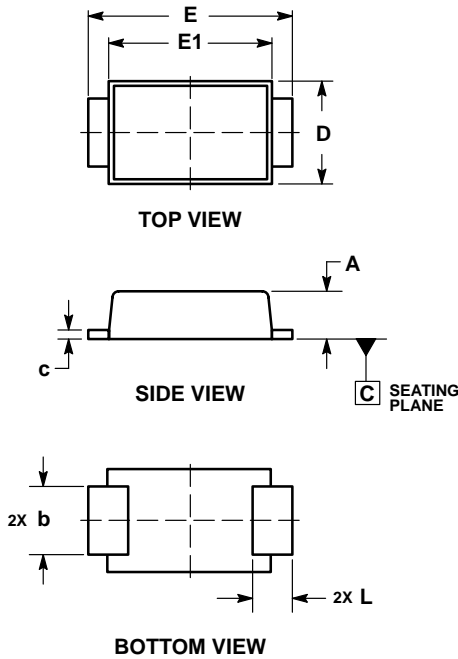

Figure 8. Typical Transient Thermal Response, Junction-to-Ambient

# MBRAF440, NRVBAF440

## PACKAGE DIMENSIONS

SMA-FL  
CASE 403AA  
ISSUE A



NOTES:

1. DIMENSIONING AND TOLERANCING PER ASME Y14.5M, 1994.
2. CONTROLLING DIMENSION: MILLIMETERS.

MILLIMETERS		
DIM	MIN	MAX
A	0.90	1.10
b	1.25	1.65
c	0.15	0.30
D	2.40	2.80
E	4.80	5.40
E1	4.00	4.60
L	0.70	1.10

### RECOMMENDED SOLDER FOOTPRINT\*

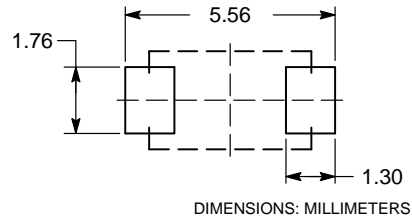

\*For additional information on our Pb-Free strategy and soldering details, please download the ON Semiconductor Soldering and Mounting Techniques Reference Manual, SOLDERRM/D.

ON Semiconductor and are trademarks of Semiconductor Components Industries, LLC dba ON Semiconductor or its subsidiaries in the United States and/or other countries. ON Semiconductor owns the rights to a number of patents, trademarks, copyrights, trade secrets, and other intellectual property. A listing of ON Semiconductor's product/patent coverage may be accessed at [www.onsemi.com/site/pdf/Patent-Marking.pdf](http://www.onsemi.com/site/pdf/Patent-Marking.pdf). ON Semiconductor reserves the right to make changes without further notice to any products herein. ON Semiconductor makes no warranty, representation or guarantee regarding the suitability of its products for any particular purpose, nor does ON Semiconductor assume any liability arising out of the application or use of any product or circuit, and specifically disclaims any and all liability, including without limitation special, consequential or incidental damages. Buyer is responsible for its products and applications using ON Semiconductor products, including compliance with all laws, regulations and safety requirements or standards, regardless of any support or applications information provided by ON Semiconductor. "Typical" parameters which may be provided in ON Semiconductor data sheets and/or specifications can and do vary in different applications and actual performance may vary over time. All operating parameters, including "Typicals" must be validated for each customer application by customer's technical experts. ON Semiconductor does not convey any license under its patent rights nor the rights of others. ON Semiconductor products are not designed, intended, or authorized for use as a critical component in life support systems or any FDA Class 3 medical devices or medical devices with a same or similar classification in a foreign jurisdiction or any devices intended for implantation in the human body. Should Buyer purchase or use ON Semiconductor products for any such unintended or unauthorized application, Buyer shall indemnify and hold ON Semiconductor and its officers, employees, subsidiaries, affiliates, and distributors harmless against all claims, costs, damages, and expenses, and reasonable attorney fees arising out of, directly or indirectly, any claim of personal injury or death associated with such unintended or unauthorized use, even if such claim alleges that ON Semiconductor was negligent regarding the design or manufacture of the part. ON Semiconductor is an Equal Opportunity/Affirmative Action Employer. This literature is subject to all applicable copyright laws and is not for resale in any manner.

### PUBLICATION ORDERING INFORMATION

**LITERATURE FULFILLMENT:**

Literature Distribution Center for ON Semiconductor  
19521 E. 32nd Pkwy, Aurora, Colorado 80011 USA  
Phone: 303-675-2175 or 800-344-3860 Toll Free USA/Canada  
Fax: 303-675-2176 or 800-344-3867 Toll Free USA/Canada  
Email: [orderlit@onsemi.com](mailto:orderlit@onsemi.com)

**N. American Technical Support:** 800-282-9855 Toll Free  
USA/Canada  
**Europe, Middle East and Africa Technical Support:**  
Phone: 421 33 790 2910  
**Japan Customer Focus Center**  
Phone: 81-3-5817-1050

**ON Semiconductor Website:** [www.onsemi.com](http://www.onsemi.com)  
**Order Literature:** <http://www.onsemi.com/orderlit>

For additional information, please contact your local Sales Representative