

Schmitt Trigger Buffer, Dual, Non-Inverting

NL27WZ17

The NL27WZ17 is a high performance dual buffer with Schmitt-Trigger inputs operating from a 1.65 to 5.5 V supply.

Features

- Designed for 1.65 V to 5.5 V V_{CC} Operation
- 3.7 ns t_{PD} at $V_{CC} = 5$ V (Typ)
- Inputs/Outputs Overvoltage Tolerant up to 5.5 V
- I_{OFF} Supports Partial Power Down Protection
- Sink 32 mA at 4.5 V
- Available in SC-88, SC-74, and UDFN6 Packages
- Chip Complexity < 100 FETs
- NLV Prefix for Automotive and Other Applications Requiring Unique Site and Control Change Requirements; AEC-Q100 Qualified and PPAP Capable
- These Devices are Pb-Free, Halogen Free/BFR Free and are RoHS Compliant

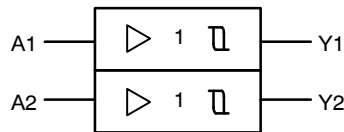

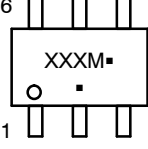

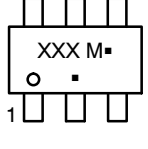





Figure 1. Logic Symbol



ON Semiconductor®

www.onsemi.com

MARKING DIAGRAMS		
	SC-88 DF SUFFIX CASE 419B-02	
	SC-74 CASE 318F-05	
	UDFN6 1.45x1.0, 0.5P CASE 517AQ	
	UDFN6 1x1, 0.35P CASE 517BX	

X, XXX = Specific Device Code
M = Date Code*
▪ = Pb-Free Package

(Note: Microdot may be in either location)

*Date Code orientation and/or position may vary depending upon manufacturing location.

ORDERING INFORMATION

See detailed ordering and shipping information in the package dimensions section on page 7 of this data sheet.

NL27WZ17

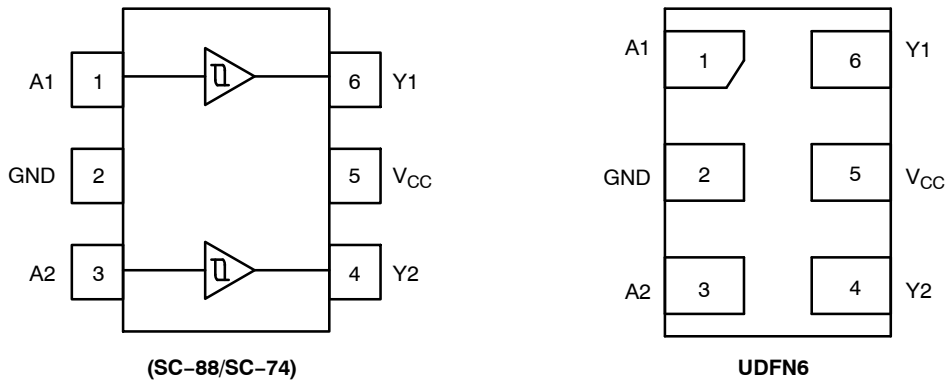

Figure 2. Pinout (Top View)

PIN ASSIGNMENT

Pin	Function
1	A1
2	GND
3	A2
4	Y2
5	V _{CC}
6	Y1

FUNCTION TABLE

A Input	Y Output
L	L
H	H

NL27WZ17

MAXIMUM RATINGS

Symbol	Characteristics	Value	Units
V _{CC}	DC Supply Voltage SC-88 (NLV) SC-88, SC-74, UDFN6	-0.5 to +7.0 -0.5 to +6.5	V
V _{IN}	DC Input Voltage SC-88 (NLV) SC-88, SC-74, UDFN6	-0.5 to +7.0 -0.5 to +6.5	V
V _{OUT}	DC Output Voltage SC-88 (NLV) Active-Mode (High or Low State) Tri-State Mode (Note 1) Power-Down Mode (V _{CC} = 0 V)	-0.5 to V _{CC} +0.5 -0.5 to +7.0 -0.5 to +7.0	V
	DC Output Voltage SC-88, SC-74, UDFN6 Active-Mode (High or Low State) Tri-State Mode (Note 1) Power-Down Mode (V _{CC} = 0 V)	-0.5 to V _{CC} +0.5 -0.5 to +6.5 -0.5 to +6.5	V
I _{IK}	DC Input Diode Current, V _{IN} < GND	-50	mA
I _{OK}	DC Output Diode Current, V _{OUT} < GND	-50	mA
I _{OUT}	DC Output Source/Sink Current	±50	mA
I _{CC} or I _{GND}	DC Supply Current per Supply Pin or Ground Pin	±100	mA
T _{STG}	Storage Temperature Range	-65 to +150	°C
T _L	Lead Temperature, 1 mm from Case for 10 secs	260	°C
T _J	Junction Temperature under Bias	+150	°C
θ _{JA}	Thermal Resistance (Note 2) SC-88 SC-74 UDFN6	377 320 154	°C/W
P _D	Power Dissipation in Still Air SC-88 SC-74 UDFN6	332 390 812	mW
MSL	Moisture Sensitivity	Level 1	-
F _R	Flameability Rating Oxygen Index: 28 to 34	UL 94-V-0 @ 0.125 in	-
V _{ESD}	ESD Withstand Voltage (Note 3) Human Body Model Charged Device Model (NLV) Charged Device Model	2000 1000 N/A	V
I _{LATCHUP}	Latchup Performance (Note 4) (NLV)	±100 ±500	mA

Stresses exceeding those listed in the Maximum Ratings table may damage the device. If any of these limits are exceeded, device functionality should not be assumed, damage may occur and reliability may be affected.

1. Applicable to devices with outputs that may be tri-stated.
2. Measured with minimum pad spacing on an FR4 board, using 10 mm-by-1 inch, 2 ounce copper trace no air flow per JESD51-7.
3. HBM tested to ANSI/ESDA/JEDEC JS-001-2017. CDM tested to EIA/JESD22-C101-F. JEDEC recommends that ESD qualification to EIA/JESD22-A115-A (Machine Model) be discontinued per JEDEC/JEP172A.
4. Tested to EIA/JESD78 Class II.

RECOMMENDED OPERATING CONDITIONS

Symbol	Parameter	Min	Max	Unit
V _{CC}	Positive DC Supply Voltage	1.65	5.5	V
V _{IN}	DC Input Voltage	0	5.5	V
V _{OUT}	DC Output Voltage Active-Mode (High or Low State) Tri-State Mode (Note 1) Power-Down Mode (V _{CC} = 0 V)	0	V _{CC}	V
		0	5.5	
		0	5.5	
T _A	Operating Temperature Range	-55	+125	°C
t _r , t _f	Input Transition Rise or Fall Rate V _{CC} = 1.65 V to 1.95 V V _{CC} = 2.3 V to 2.7 V V _{CC} = 3.0 V to 3.6 V V _{CC} = 4.5 V to 5.5 V	0 0 0 0	No Limit No Limit No Limit No Limit	ns

Functional operation above the stresses listed in the Recommended Operating Ranges is not implied. Extended exposure to stresses beyond the Recommended Operating Ranges limits may affect device reliability.

NL27WZ17

DC ELECTRICAL CHARACTERISTICS

Symbol	Parameter	Condition	V _{CC} (V)	T _A = 25°C			-40°C ≤ T _A ≤ 85°C		-55°C ≤ T _A ≤ 125°C		Unit
				Min	Typ	Max	Min	Max	Min	Max	
V _{T+}	Positive Input Threshold Voltage		1.65	-	1.0	1.4	-	1.4	-	1.4	V
			2.3	-	1.5	1.8	-	1.8	-	1.8	
			2.7	-	1.7	2	-	2	-	2	
			3	-	1.9	2.2	-	2.2	-	2.2	
			4.5	-	2.7	3.1	-	3.1	-	3.1	
			5.5	-	3.3	3.6	-	3.6	-	3.6	
V _{T-}	Negative Input Threshold Voltage		1.65	0.2	0.5	-	0.2	-	0.2	-	V
			2.3	0.4	0.75	-	0.4	-	0.4	-	
			2.7	0.5	0.87	-	0.5	-	0.5	-	
			3	0.6	1.0	-	0.6	-	0.6	-	
			4.5	1.0	1.5	-	1.0	-	1.0	-	
			5.5	1.2	1.9	-	1.2	-	1.2	-	
V _H	Input Hysteresis Voltage		1.65	0.1	0.48	0.9	0.1	0.9	0.1	0.9	V
			2.3	0.25	0.75	1.1	0.25	1.1	0.25	1.1	
			2.7	0.3	0.83	1.15	0.3	1.15	0.3	1.15	
			3	0.4	0.93	1.2	0.4	1.2	0.4	1.2	
			4.5	0.6	1.2	1.5	0.6	1.5	0.6	1.5	
			5.5	0.7	1.4	1.7	0.7	1.7	0.7	1.7	
V _{OH}	High-Level Output Voltage V _{IN} = V _{IH} or V _{IL}	I _{OH} = -100 μA	1.65 to 5.5	V _{CC} - 0.1	V _{CC}	-	V _{CC} - 0.1	-	V _{CC} - 0.1	-	V
		I _{OH} = -4 mA	1.65	1.29	1.52	-	1.29	-	1.29	-	
		I _{OH} = -8 mA	2.3	1.9	2.1	-	1.9	-	1.9	-	
		I _{OH} = -12 mA	2.7	2.2	2.4	-	2.2	-	2.2	-	
		I _{OH} = -16 mA	3	2.4	2.7	-	2.4	-	2.4	-	
		I _{OH} = -24 mA	3	2.3	2.5	-	2.3	-	2.3	-	
		I _{OH} = -32 mA	4.5	3.8	4	-	3.8	-	3.8	-	
V _{OL}	Low-Level Output Voltage V _{IN} = V _{IH} or V _{IL}	I _{OL} = 100 μA	1.65 to 5.5	-	-	0.1	-	0.1	-	0.1	V
		I _{OL} = 4 mA	1.65	-	0.08	0.24	-	0.24	-	0.24	
		I _{OL} = 8 mA	2.3	-	0.2	0.3	-	0.3	-	0.3	
		I _{OL} = 12 mA	2.7	-	0.22	0.4	-	0.4	-	0.4	
		I _{OL} = 16 mA	3	-	0.28	0.4	-	0.4	-	0.4	
		I _{OL} = 24 mA	3	-	0.38	0.55	-	0.55	-	0.55	
		I _{OL} = 32 mA	4.5	-	0.42	0.55	-	0.55	-	0.55	
I _{IN}	Input Leakage Current	V _{IN} = 5.5 V or GND	1.65 to 5.5	-	-	±0.1	-	±1.0	-	±1.0	μA
I _{OFF}	Power Off Leakage Current	V _{IN} = 5.5 V or V _{OUT} = 5.5 V	0	-	-	1	-	10	-	10	μA
I _{CC}	Quiescent Supply Current	V _{IN} = 5.5 V or GND	5.5	-	-	1	-	10	-	10	μA

NL27WZ17

AC ELECTRICAL CHARACTERISTICS

Symbol	Parameter	Condition	V _{CC} (V)	T _A = 25°C			-40°C ≤ T _A ≤ 85°C		-55°C ≤ T _A ≤ 125°C		Unit
				Min	Typ	Max	Min	Max	Min	Max	
t _{PLH} , t _{PHL}	Propagation Delay, A to Y (Figures 3 and 4)	R _L = 1 MΩ, C _L = 15 pF	1.65 to 1.95	-	9.1	15	-	15.6	-	15.6	ns
			2.3 to 2.7	-	5.0	9.0	-	9.5	-	9.5	
		R _L = 1 MΩ, C _L = 15 pF	3.0 to 3.6	-	3.7	6.3	-	6.5	-	6.5	
			4.5 to 5.5	-	3.1	5.2	-	5.5	-	5.5	
			R _L = 500 Ω, C _L = 50 pF	3.0 to 3.6	-	4.4	7.2	-	7.5	-	
		4.5 to 5.5		-	3.7	5.9	-	6.2	-	6.2	

CAPACITIVE CHARACTERISTICS

Symbol	Parameter	Condition	Typical	Unit
C _{IN}	Input Capacitance	V _{CC} = 5.5 V, V _I = 0 V or V _{CC}	2.5	pF
C _{OUT}	Output Capacitance	V _{CC} = 5.5 V, V _I = 0 V or V _{CC}	4.0	pF
C _{PD}	Power Dissipation Capacitance (Note 5)	10 MHz, V _{CC} = 3.3 V, V _{IN} = 0 V or V _{CC} 10 MHz, V _{CC} = 5.0 V, V _{IN} = 0 V or V _{CC}	11 12.5	pF

5. C_{PD} is defined as the value of the internal equivalent capacitance which is calculated from the operating current consumption without load. Average operating current can be obtained by the equation: $I_{CC(OPR)} = C_{PD} \cdot V_{CC} \cdot f_{in} \cdot I_{CC}$. C_{PD} is used to determine the no-load dynamic power consumption; $P_D = C_{PD} \cdot V_{CC}^2 \cdot f_{in} \cdot I_{CC} \cdot V_{CC}$.

NL27WZ17



C_L includes probe and jig capacitance
 R_T is Z_{OUT} of pulse generator (typically 50 Ω)
 $f = 1$ MHz

Figure 3. Test Circuit

Test	Switch Position	C_L , pF	R_L , Ω	R_1 , Ω
t_{PLH} / t_{PHL}	Open	See AC Characteristics Table		
t_{PLZ} / t_{PZL}	$2 \times V_{CC}$	-	-	-
		See AC Characteristics Table		
t_{PHZ} / t_{PZH}	GND	-	-	-
		See AC Characteristics Table		

X = Don't Care



Figure 4. Switching Waveforms

V_{CC} , V	V_{mi} , V	V_{mo} , V		V_Y , V
		t_{PLH} , t_{PHL}	t_{PZL} , t_{PLZ} , t_{PZH} , t_{PHZ}	
1.65 to 1.95	$V_{CC}/2$	$V_{CC}/2$	$V_{CC}/2$	0.15
2.3 to 2.7	$V_{CC}/2$	$V_{CC}/2$	$V_{CC}/2$	0.15
3.0 to 3.6	$V_{CC}/2$	$V_{CC}/2$	$V_{CC}/2$	0.3
4.5 to 5.5	$V_{CC}/2$	$V_{CC}/2$	$V_{CC}/2$	0.3

NL27WZ17

ORDERING INFORMATION

Device	Package	Specific Device Code	Pin1 Orientation (See below)	Shipping†
NL27WZ17DFT2G	SC-88	MX	Q4	3000 / Tape & Reel
NLV27WZ17DFT2G*	SC-88	MX	Q4	3000 / Tape & Reel
NL27WZ17DBVT1G	SC-74	AC	Q4	3000 / Tape & Reel
NL27WZ17MU1TCG	UDFN6 1.45 x 1.0, 0.5P	K (Rotated 90° CW)	Q4	3000 / Tape & Reel
NL27WZ17MU3TCG	UDFN6 1.0 x 1.0, 0.35P	D	Q4	3000 / Tape & Reel

†For information on tape and reel specifications, including part orientation and tape sizes, please refer to our Tape and Reel Packaging Specifications Brochure, BRD8011/D.

*NLV Prefix for Automotive and Other Applications Requiring Unique Site and Control Change Requirements; AEC-Q100 Qualified and PPAP Capable.

Pin 1 Orientation in Tape and Reel

Direction of Feed

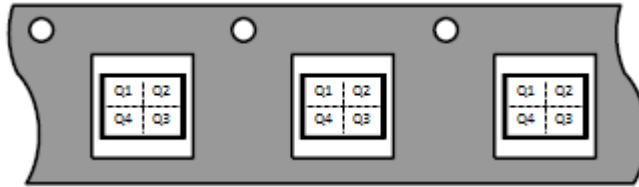

MECHANICAL CASE OUTLINE PACKAGE DIMENSIONS



SCALE 2:1

SC-74
CASE 318F
ISSUE P

DATE 07 OCT 2021

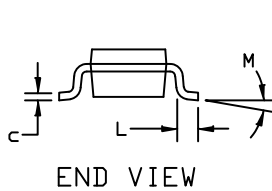
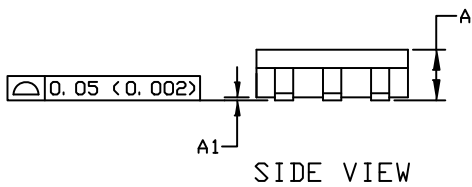
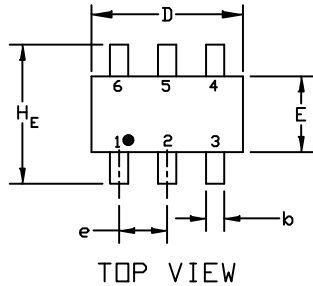

GENERIC MARKING DIAGRAM*

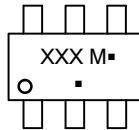

XXX = Specific Device Code
M = Date Code
▪ = Pb-Free Package

(Note: Microdot may be in either location)

*This information is generic. Please refer to device data sheet for actual part marking. Pb-Free indicator, "G" or microdot "▪", may or may not be present. Some products may not follow the Generic Marking.

NOTES:

1. DIMENSIONING AND TOLERANCING PER ASME Y14.5M, 1994
2. CONTROLLING DIMENSION: INCHES
3. MAXIMUM LEAD THICKNESS INCLUDES LEAD FINISH THICKNESS. MINIMUM LEAD THICKNESS IS THE MINIMUM THICKNESS OF THE BASE MATERIAL.

DIM	MILLIMETERS			INCHES		
	MIN.	NOM.	MAX.	MIN.	NOM.	MAX.
A	0.90	1.00	1.10	0.035	0.039	0.043
A1	0.01	0.06	0.10	0.001	0.002	0.004
b	0.25	0.37	0.50	0.010	0.015	0.020
c	0.10	0.18	0.26	0.004	0.007	0.010
D	2.90	3.00	3.10	0.114	0.118	0.122
E	1.30	1.50	1.70	0.051	0.059	0.067
e	0.85	0.95	1.05	0.034	0.037	0.041
HE	2.50	2.75	3.00	0.099	0.108	0.118
L	0.20	0.40	0.60	0.008	0.016	0.024
M	0*	---	10*	0*	---	10*

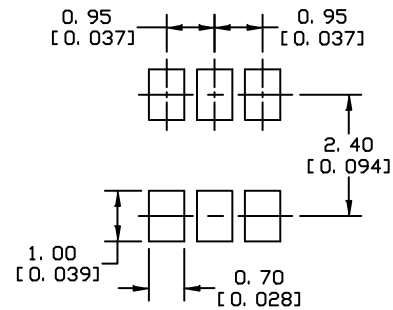

* For additional information on our Pb-Free strategy and soldering details, please download the DN Semiconductor Soldering and Mounting Techniques Reference Manual, SOLDERM/D.

SOLDERING FOOTPRINT

STYLE 1:

- PIN 1. CATHODE
- 2. ANODE
- 3. CATHODE
- 4. CATHODE
- 5. ANODE
- 6. CATHODE

STYLE 2:

- PIN 1. NO CONNECTION
- 2. COLLECTOR
- 3. EMITTER
- 4. NO CONNECTION
- 5. COLLECTOR
- 6. BASE

STYLE 3:

- PIN 1. EMITTER 1
- 2. BASE 1
- 3. COLLECTOR 2
- 4. EMITTER 2
- 5. BASE 2
- 6. COLLECTOR 1

STYLE 4:

- PIN 1. COLLECTOR 2
- 2. EMITTER 1/EMITTER 2
- 3. COLLECTOR 1
- 4. EMITTER 3
- 5. BASE 1/BASE 2/COLLECTOR 3
- 6. BASE 3

STYLE 5:

- PIN 1. CHANNEL 1
- 2. ANODE
- 3. CHANNEL 2
- 4. CHANNEL 3
- 5. CATHODE
- 6. CHANNEL 4

STYLE 6:

- PIN 1. CATHODE
- 2. ANODE
- 3. CATHODE
- 4. CATHODE
- 5. CATHODE
- 6. CATHODE

STYLE 7:

- PIN 1. SOURCE 1
- 2. GATE 1
- 3. DRAIN 2
- 4. SOURCE 2
- 5. GATE 2
- 6. DRAIN 1

STYLE 8:

- PIN 1. EMITTER 1
- 2. BASE 2
- 3. COLLECTOR 2
- 4. EMITTER 2
- 5. BASE 1
- 6. COLLECTOR 1

STYLE 9:

- PIN 1. EMITTER 2
- 2. BASE 2
- 3. COLLECTOR 1
- 4. EMITTER 1
- 5. BASE 1
- 6. COLLECTOR 2

STYLE 10:

- PIN 1. ANODE/CATHODE
- 2. BASE
- 3. EMITTER
- 4. COLLECTOR
- 5. ANODE
- 6. CATHODE

STYLE 11:

- PIN 1. EMITTER
- 2. BASE
- 3. ANODE/CATHODE
- 4. ANODE
- 5. CATHODE
- 6. COLLECTOR

DOCUMENT NUMBER:	98ASB42973B	Electronic versions are uncontrolled except when accessed directly from the Document Repository. Printed versions are uncontrolled except when stamped "CONTROLLED COPY" in red.
DESCRIPTION:	SC-74	PAGE 1 OF 1

onsemi and ONSEMI are trademarks of Semiconductor Components Industries, LLC dba onsemi or its subsidiaries in the United States and/or other countries. onsemi reserves the right to make changes without further notice to any products herein. onsemi makes no warranty, representation or guarantee regarding the suitability of its products for any particular purpose, nor does onsemi assume any liability arising out of the application or use of any product or circuit, and specifically disclaims any and all liability, including without limitation special, consequential or incidental damages. onsemi does not convey any license under its patent rights nor the rights of others.



1
 SCALE 2:1

SC-88/SC70-6/SOT-363
 CASE 419B-02
 ISSUE Y

DATE 11 DEC 2012

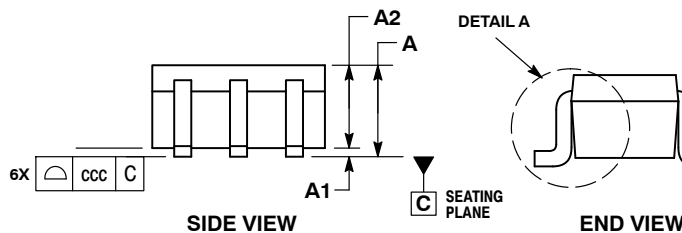
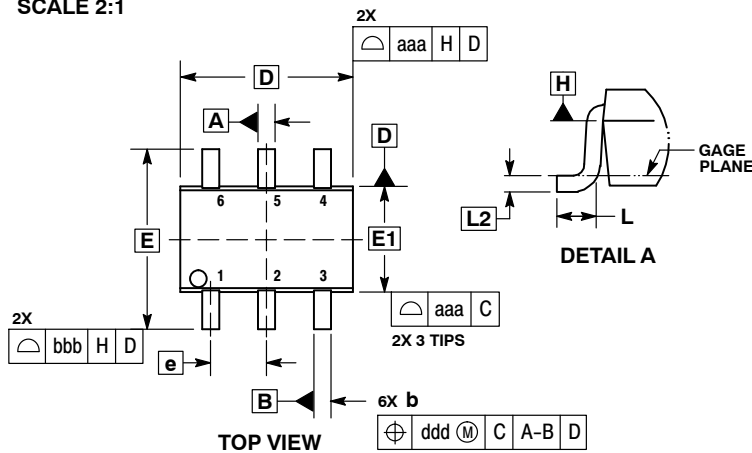

- NOTES:
1. DIMENSIONING AND TOLERANCING PER ASME Y14.5M, 1994.
 2. CONTROLLING DIMENSION: MILLIMETERS.
 3. DIMENSIONS D AND E1 DO NOT INCLUDE MOLD FLASH, PROTRUSIONS, OR GATE BURRS. MOLD FLASH, PROTRUSIONS, OR GATE BURRS SHALL NOT EXCEED 0.20 PER END.
 4. DIMENSIONS D AND E1 AT THE OUTERMOST EXTREMES OF THE PLASTIC BODY AND DATUM H.
 5. DATUMS A AND B ARE DETERMINED AT DATUM H.
 6. DIMENSIONS b AND c APPLY TO THE FLAT SECTION OF THE LEAD BETWEEN 0.08 AND 0.15 FROM THE TIP.
 7. DIMENSION b DOES NOT INCLUDE DAMBAR PROTRUSION. ALLOWABLE DAMBAR PROTRUSION SHALL BE 0.08 TOTAL IN EXCESS OF DIMENSION b AT MAXIMUM MATERIAL CONDITION. THE DAMBAR CANNOT BE LOCATED ON THE LOWER RADIUS OF THE FOOT.

DIM	MILLIMETERS			INCHES		
	MIN	NOM	MAX	MIN	NOM	MAX
A	---	---	1.10	---	---	0.043
A1	0.00	---	0.10	0.000	---	0.004
A2	0.70	0.90	1.00	0.027	0.035	0.039
b	0.15	0.20	0.25	0.006	0.008	0.010
C	0.08	0.15	0.22	0.003	0.006	0.009
D	1.80	2.00	2.20	0.070	0.078	0.086
E	2.00	2.10	2.20	0.078	0.082	0.086
E1	1.15	1.25	1.35	0.045	0.049	0.053
e	0.65 BSC			0.026 BSC		
L	0.26	0.36	0.46	0.010	0.014	0.018
L2	0.15 BSC			0.006 BSC		
aaa	0.15			0.006		
bbb	0.30			0.012		
ccc	0.10			0.004		
ddd	0.10			0.004		

GENERIC MARKING DIAGRAM*

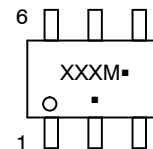

- XXX = Specific Device Code
- M = Date Code*
- = Pb-Free Package

(Note: Microdot may be in either location)

*Date Code orientation and/or position may vary depending upon manufacturing location.

*This information is generic. Please refer to device data sheet for actual part marking. Pb-Free indicator, "G" or microdot "▪", may or may not be present. Some products may not follow the Generic Marking.

RECOMMENDED SOLDERING FOOTPRINT*

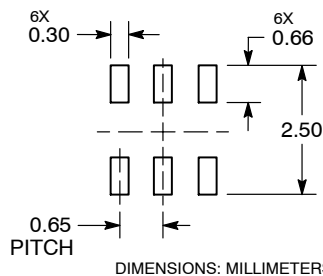

*For additional information on our Pb-Free strategy and soldering details, please download the ON Semiconductor Soldering and Mounting Techniques Reference Manual, SOLDERRM/D.

STYLES ON PAGE 2

DOCUMENT NUMBER:	98ASB42985B	Electronic versions are uncontrolled except when accessed directly from the Document Repository. Printed versions are uncontrolled except when stamped "CONTROLLED COPY" in red.
DESCRIPTION:	SC-88/SC70-6/SOT-363	PAGE 1 OF 2

ON Semiconductor and ON are trademarks of Semiconductor Components Industries, LLC dba ON Semiconductor or its subsidiaries in the United States and/or other countries. ON Semiconductor reserves the right to make changes without further notice to any products herein. ON Semiconductor makes no warranty, representation or guarantee regarding the suitability of its products for any particular purpose, nor does ON Semiconductor assume any liability arising out of the application or use of any product or circuit, and specifically disclaims any and all liability, including without limitation special, consequential or incidental damages. ON Semiconductor does not convey any license under its patent rights nor the rights of others.

SC-88/SC70-6/SOT-363
CASE 419B-02
ISSUE Y

DATE 11 DEC 2012

STYLE 1: PIN 1. EMITTER 2 2. BASE 2 3. COLLECTOR 1 4. EMITTER 1 5. BASE 1 6. COLLECTOR 2	STYLE 2: CANCELLED	STYLE 3: CANCELLED	STYLE 4: PIN 1. CATHODE 2. CATHODE 3. COLLECTOR 4. EMITTER 5. BASE 6. ANODE	STYLE 5: PIN 1. ANODE 2. ANODE 3. COLLECTOR 4. EMITTER 5. BASE 6. CATHODE	STYLE 6: PIN 1. ANODE 2 2. N/C 3. CATHODE 1 4. ANODE 1 5. N/C 6. CATHODE 2
STYLE 7: PIN 1. SOURCE 2 2. DRAIN 2 3. GATE 1 4. SOURCE 1 5. DRAIN 1 6. GATE 2	STYLE 8: CANCELLED	STYLE 9: PIN 1. EMITTER 2 2. EMITTER 1 3. COLLECTOR 1 4. BASE 1 5. BASE 2 6. COLLECTOR 2	STYLE 10: PIN 1. SOURCE 2 2. SOURCE 1 3. GATE 1 4. DRAIN 1 5. DRAIN 2 6. GATE 2	STYLE 11: PIN 1. CATHODE 2 2. CATHODE 2 3. ANODE 1 4. CATHODE 1 5. CATHODE 1 6. ANODE 2	STYLE 12: PIN 1. ANODE 2 2. ANODE 2 3. CATHODE 1 4. ANODE 1 5. ANODE 1 6. CATHODE 2
STYLE 13: PIN 1. ANODE 2. N/C 3. COLLECTOR 4. EMITTER 5. BASE 6. CATHODE	STYLE 14: PIN 1. VREF 2. GND 3. GND 4. IOUT 5. VEN 6. VCC	STYLE 15: PIN 1. ANODE 1 2. ANODE 2 3. ANODE 3 4. CATHODE 3 5. CATHODE 2 6. CATHODE 1	STYLE 16: PIN 1. BASE 1 2. EMITTER 2 3. COLLECTOR 2 4. BASE 2 5. EMITTER 1 6. COLLECTOR 1	STYLE 17: PIN 1. BASE 1 2. EMITTER 1 3. COLLECTOR 2 4. BASE 2 5. EMITTER 2 6. COLLECTOR 1	STYLE 18: PIN 1. VIN1 2. VCC 3. VOUT2 4. VIN2 5. GND 6. VOUT1
STYLE 19: PIN 1. IOUT 2. GND 3. GND 4. V CC 5. V EN 6. V REF	STYLE 20: PIN 1. COLLECTOR 2. COLLECTOR 3. BASE 4. EMITTER 5. COLLECTOR 6. COLLECTOR	STYLE 21: PIN 1. ANODE 1 2. N/C 3. ANODE 2 4. CATHODE 2 5. N/C 6. CATHODE 1	STYLE 22: PIN 1. D1 (i) 2. GND 3. D2 (i) 4. D2 (c) 5. VBUS 6. D1 (c)	STYLE 23: PIN 1. Vn 2. CH1 3. Vp 4. N/C 5. CH2 6. N/C	STYLE 24: PIN 1. CATHODE 2. ANODE 3. CATHODE 4. CATHODE 5. CATHODE 6. CATHODE
STYLE 25: PIN 1. BASE 1 2. CATHODE 3. COLLECTOR 2 4. BASE 2 5. EMITTER 6. COLLECTOR 1	STYLE 26: PIN 1. SOURCE 1 2. GATE 1 3. DRAIN 2 4. SOURCE 2 5. GATE 2 6. DRAIN 1	STYLE 27: PIN 1. BASE 2 2. BASE 1 3. COLLECTOR 1 4. EMITTER 1 5. EMITTER 2 6. COLLECTOR 2	STYLE 28: PIN 1. DRAIN 2. DRAIN 3. GATE 4. SOURCE 5. DRAIN 6. DRAIN	STYLE 29: PIN 1. ANODE 2. ANODE 3. COLLECTOR 4. EMITTER 5. BASE/ANODE 6. CATHODE	STYLE 30: PIN 1. SOURCE 1 2. DRAIN 2 3. DRAIN 2 4. SOURCE 2 5. GATE 1 6. DRAIN 1

Note: Please refer to datasheet for style callout. If style type is not called out in the datasheet refer to the device datasheet pinout or pin assignment.

DOCUMENT NUMBER:	98ASB42985B	Electronic versions are uncontrolled except when accessed directly from the Document Repository. Printed versions are uncontrolled except when stamped "CONTROLLED COPY" in red.
DESCRIPTION:	SC-88/SC70-6/SOT-363	PAGE 2 OF 2

ON Semiconductor and  are trademarks of Semiconductor Components Industries, LLC dba ON Semiconductor or its subsidiaries in the United States and/or other countries. ON Semiconductor reserves the right to make changes without further notice to any products herein. ON Semiconductor makes no warranty, representation or guarantee regarding the suitability of its products for any particular purpose, nor does ON Semiconductor assume any liability arising out of the application or use of any product or circuit, and specifically disclaims any and all liability, including without limitation special, consequential or incidental damages. ON Semiconductor does not convey any license under its patent rights nor the rights of others.

MECHANICAL CASE OUTLINE PACKAGE DIMENSIONS



SCALE 4:1

UDFN6, 1.45x1.0, 0.5P
CASE 517AQ
ISSUE O

DATE 15 MAY 2008



DETAIL A
OPTIONAL
CONSTRUCTIONS

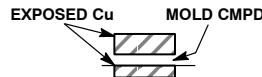

DETAIL B
OPTIONAL
CONSTRUCTIONS

NOTES:

1. DIMENSIONING AND TOLERANCING PER ASME Y14.5M, 1994.
2. CONTROLLING DIMENSION: MILLIMETERS.
3. DIMENSION b APPLIES TO PLATED TERMINAL AND IS MEASURED BETWEEN 0.15 AND 0.30 mm FROM THE TERMINAL TIP.

MILLIMETERS		
DIM	MIN	MAX
A	0.45	0.55
A1	0.00	0.05
A2	0.07	REF
b	0.20	0.30
D	1.45	BSC
E	1.00	BSC
e	0.50	BSC
L	0.30	0.40
L1	---	0.15

MOUNTING FOOTPRINT



DIMENSIONS: MILLIMETERS

*For additional information on our Pb-Free strategy and soldering details, please download the ON Semiconductor Soldering and Mounting Techniques Reference Manual, SOLDERRM/D.

**GENERIC
MARKING DIAGRAM***



X = Specific Device Code
M = Date Code

*This information is generic. Please refer to device data sheet for actual part marking. Pb-Free indicator, "G" or microdot "▪", may or may not be present.

DOCUMENT NUMBER:	98AON30313E	Electronic versions are uncontrolled except when accessed directly from the Document Repository. Printed versions are uncontrolled except when stamped "CONTROLLED COPY" in red.
DESCRIPTION:	UDFN6, 1.45x1.0, 0.5P	PAGE 1 OF 1

onsemi and ONsemi are trademarks of Semiconductor Components Industries, LLC dba onsemi or its subsidiaries in the United States and/or other countries. onsemi reserves the right to make changes without further notice to any products herein. onsemi makes no warranty, representation or guarantee regarding the suitability of its products for any particular purpose, nor does onsemi assume any liability arising out of the application or use of any product or circuit, and specifically disclaims any and all liability, including without limitation special, consequential or incidental damages. onsemi does not convey any license under its patent rights nor the rights of others.

MECHANICAL CASE OUTLINE PACKAGE DIMENSIONS



UDFN6, 1x1, 0.35P
CASE 517BX
ISSUE O

SCALE 4:1

DATE 18 MAY 2011



NOTES:

1. DIMENSIONING AND TOLERANCING PER ASME Y14.5M, 1994.
2. CONTROLLING DIMENSION: MILLIMETERS.
3. DIMENSION b APPLIES TO PLATED TERMINAL AND IS MEASURED BETWEEN 0.15 AND 0.20 MM FROM TERMINAL TIP.
4. PACKAGE DIMENSIONS EXCLUSIVE OF BURRS AND MOLD FLASH.

MILLIMETERS		
DIM	MIN	MAX
A	0.45	0.55
A1	0.00	0.05
A3	0.13	REF
b	0.12	0.22
D	1.00	BSC
E	1.00	BSC
e	0.35	BSC
L	0.25	0.35
L1	0.30	0.40

**RECOMMENDED
SOLDERING FOOTPRINT***

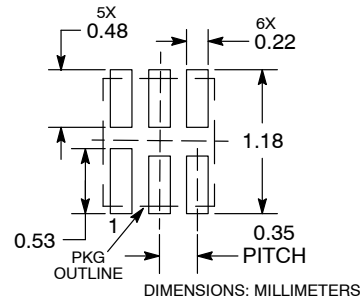

*For additional information on our Pb-Free strategy and soldering details, please download the ON Semiconductor Soldering and Mounting Techniques Reference Manual, SOLDERRM/D.

**GENERIC
MARKING DIAGRAM***

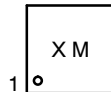

X = Specific Device Code
M = Date Code

*This information is generic. Please refer to device data sheet for actual part marking. Pb-Free indicator, "G" or microdot "▪", may or may not be present. Some products may not follow the Generic Marking.

DOCUMENT NUMBER:	98AON56787E	Electronic versions are uncontrolled except when accessed directly from the Document Repository. Printed versions are uncontrolled except when stamped "CONTROLLED COPY" in red.
DESCRIPTION:	UDFN6, 1x1, 0.35P	PAGE 1 OF 1

onsemi and onsemi are trademarks of Semiconductor Components Industries, LLC dba onsemi or its subsidiaries in the United States and/or other countries. onsemi reserves the right to make changes without further notice to any products herein. onsemi makes no warranty, representation or guarantee regarding the suitability of its products for any particular purpose, nor does onsemi assume any liability arising out of the application or use of any product or circuit, and specifically disclaims any and all liability, including without limitation special, consequential or incidental damages. onsemi does not convey any license under its patent rights nor the rights of others.

onsemi, **Onsemi**, and other names, marks, and brands are registered and/or common law trademarks of Semiconductor Components Industries, LLC dba "**onsemi**" or its affiliates and/or subsidiaries in the United States and/or other countries. **onsemi** owns the rights to a number of patents, trademarks, copyrights, trade secrets, and other intellectual property. A listing of **onsemi**'s product/patent coverage may be accessed at www.onsemi.com/site/pdf/Patent-Marking.pdf. **onsemi** reserves the right to make changes at any time to any products or information herein, without notice. The information herein is provided "as-is" and **onsemi** makes no warranty, representation or guarantee regarding the accuracy of the information, product features, availability, functionality, or suitability of its products for any particular purpose, nor does **onsemi** assume any liability arising out of the application or use of any product or circuit, and specifically disclaims any and all liability, including without limitation special, consequential or incidental damages. Buyer is responsible for its products and applications using **onsemi** products, including compliance with all laws, regulations and safety requirements or standards, regardless of any support or applications information provided by **onsemi**. "Typical" parameters which may be provided in **onsemi** data sheets and/or specifications can and do vary in different applications and actual performance may vary over time. All operating parameters, including "Typicals" must be validated for each customer application by customer's technical experts. **onsemi** does not convey any license under any of its intellectual property rights nor the rights of others. **onsemi** products are not designed, intended, or authorized for use as a critical component in life support systems or any FDA Class 3 medical devices or medical devices with a same or similar classification in a foreign jurisdiction or any devices intended for implantation in the human body. Should Buyer purchase or use **onsemi** products for any such unintended or unauthorized application, Buyer shall indemnify and hold **onsemi** and its officers, employees, subsidiaries, affiliates, and distributors harmless against all claims, costs, damages, and expenses, and reasonable attorney fees arising out of, directly or indirectly, any claim of personal injury or death associated with such unintended or unauthorized use, even if such claim alleges that **onsemi** was negligent regarding the design or manufacture of the part. **onsemi** is an Equal Opportunity/Affirmative Action Employer. This literature is subject to all applicable copyright laws and is not for resale in any manner.

PUBLICATION ORDERING INFORMATION

LITERATURE FULFILLMENT:

Email Requests to: orderlit@onsemi.com

onsemi Website: www.onsemi.com

TECHNICAL SUPPORT

North American Technical Support:

Voice Mail: 1 800-282-9855 Toll Free USA/Canada

Phone: 011 421 33 790 2910

Europe, Middle East and Africa Technical Support:

Phone: 00421 33 790 2910

For additional information, please contact your local Sales Representative