

NGTB15N60R2FG

IGBT 600V, 14A, N-Channel



ON Semiconductor®

www.onsemi.com

Features

- Reverse Conducting II IGBT
- IGBT $V_{CE(sat)}=1.85V$ typ. ($I_C=15A$, $V_{GE}=15V$)
- IGBT $t_f=75ns$ typ.
- Diode $V_F=1.7V$ typ. ($I_F=15A$)
- Diode $t_{rr}=95ns$ typ.
- $10\mu s$ Short Circuit Capability

Applications

- General Purpose Inverter

Specifications

Absolute Maximum Ratings at $T_a = 25^\circ C$, Unless otherwise specified

Parameter	Symbol	Value	Unit
Collector to Emitter Voltage	V_{CES}	600	V
Gate to Emitter Voltage	V_{GES}	± 20	V
Collector Current (DC)	I_C *1	24	A
Limited by T_{jmax}		@ $T_c=100^\circ C$ *2	14
Collector Current (Peak)	I_{CP}	60	A
Pulse width Limited by T_{jmax}			
Diode Average Output Current	I_O	15	A
Power Dissipation	P_D	54	W
$T_c=25^\circ C$ (Our ideal heat dissipation condition) *2			
Junction Temperature	T_j	175	$^\circ C$
Storage Temperature	T_{stg}	-55 to +175	$^\circ C$

Note : *1 Collector Current is calculated from the following formula.

$$I_C(T_c) = \frac{T_{jmax} - T_c}{R_{th(j-c)} \times V_{CE(sat)}(I_C(T_c))}$$

*2 Our condition is radiation from backside.

The method is applying silicone grease to the backside of the device and attaching the device to water-cooled radiator made of aluminum.

Stresses exceeding those listed in the Maximum Ratings table may damage the device. If any of these limits are exceeded, device functionality should not be assumed, damage may occur and reliability may be affected.

Electrical Connection N-Channel

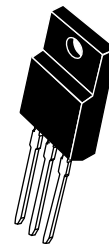
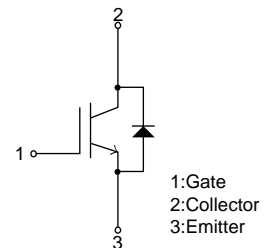

TO-220F-3FS

Marking

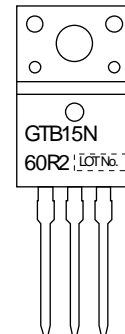

ORDERING INFORMATION

See detailed ordering and shipping information on page 7 of this data sheet.

NGTB15N60R2FG

Electrical Characteristics at Ta = 25°C, Unless otherwise specified

Parameter	Symbol	Conditions	Value			Unit	
			min	typ	max		
Collector to Emitter Breakdown Voltage	V(BR)CES	IC=500μA, VGE=0V	600			V	
Collector to Emitter Cut off Current	ICES	VCE=600V, VGE=0V	Tc=25°C		10	μA	
			Tc=125°C		1	mA	
Gate to Emitter Leakage Current	IGES	VGE=±20V, VCE=0V			±100	nA	
Gate to Emitter Threshold Voltage	VGE(th)	VCE=20V, IC=250μA	4.5		7.0	V	
Collector to Emitter Saturation Voltage	VCE(sat)	VGE=15V, IC=15A		1.85	2.1	V	
		VGE=15V, IC=14A	Tc=100°C		2.0	2.3	V
Forward Diode Voltage	VF	IF=15A		1.7	2.1	V	
Input Capacitance	Cies	VCE=20V, f=1MHz		2000		pF	
Output Capacitance	Coes			65		pF	
Reverse Transfer Capacitance	Cres			50		pF	
Turn-ON Delay Time	t _{d(on)}			70		ns	
Rise Time	t _r	VCC=300V, IC=15A RG=30Ω, L=500μH VGE=0V/15V Vclamp=400V Tc=25°C See Fig.1, See Fig.2		40		ns	
Turn-ON Time	ton			200		ns	
Turn-OFF Delay Time	t _{d(off)}			190		ns	
Fall Time	t _f			75		ns	
Turn-OFF Time	toff			290		ns	
Turn-ON Energy	Eon			550		μJ	
Turn-OFF Energy	Eoff			220		μJ	
Total Gate Charge	Qg			80		nC	
Gate to Emitter Charge	Qge		VCE=300V, VGE=15V, IC=15A		16		nC
Gate to Collector "Miller" Charge	Qgc				38		nC
Diode Reverse Recovery Time	t _{rr}	IF=15A, di/dt=300A/μs, VCC=300V, See Fig.3		95		ns	

Product parametric performance is indicated in the Electrical Characteristics for the listed test conditions, unless otherwise noted. Product performance may not be indicated by the Electrical Characteristics if operated under different conditions.

Thermal Characteristics at Ta = 25°C, Unless otherwise specified

Parameter	Symbol	Conditions	Value	Unit
Thermal Resistance IGBT (Junction to Case)	Rth(j-c) (IGBT)	Tc=25°C (Our ideal heat dissipation condition) *2	2.78	°C/W
Thermal Resistance (Junction to Ambient)	Rth(j-a)		69	°C/W

Note : *2 Our condition is radiation from backside.

The method is applying silicone grease to the backside of the device and attaching the device to water-cooled radiator made of aluminum.

NGTB15N60R2FG

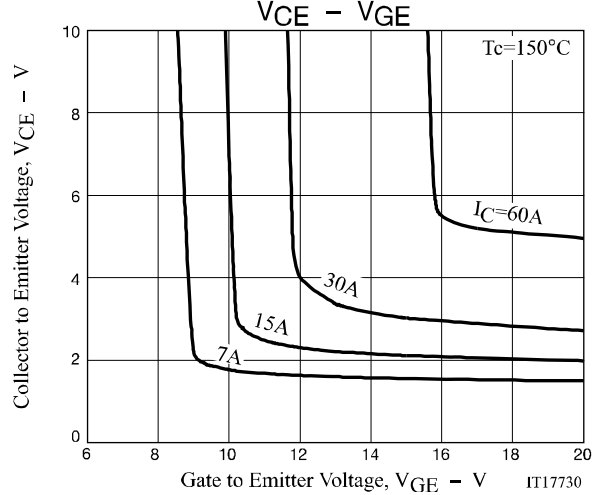
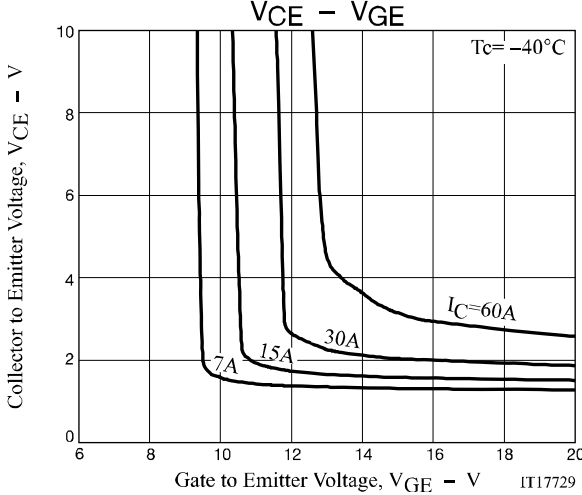
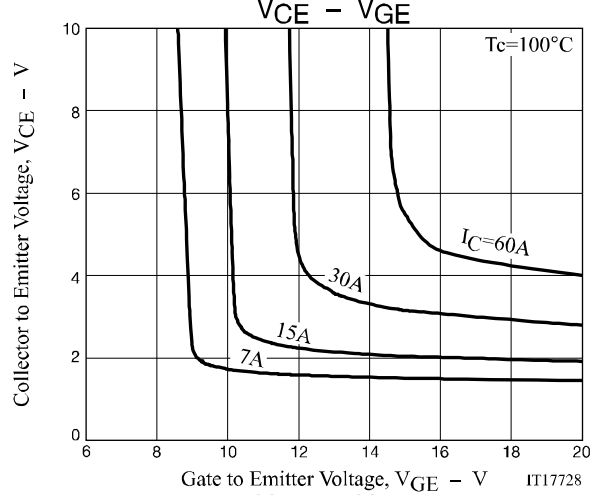
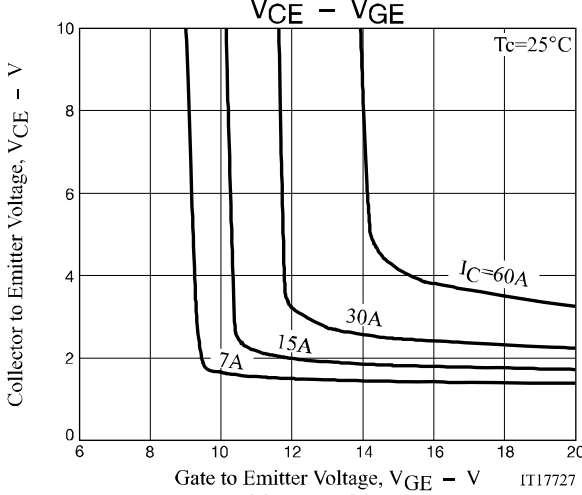
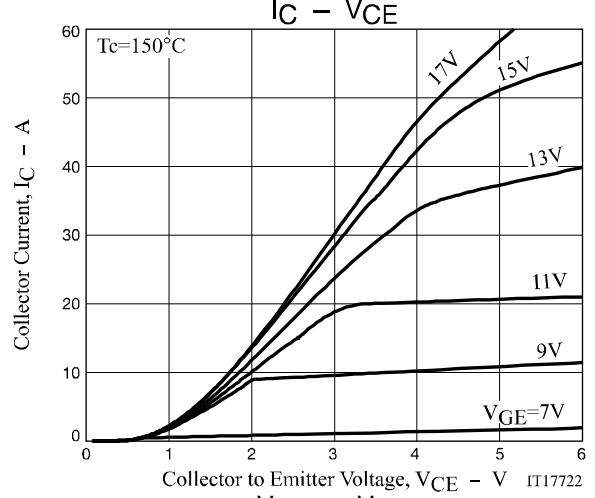
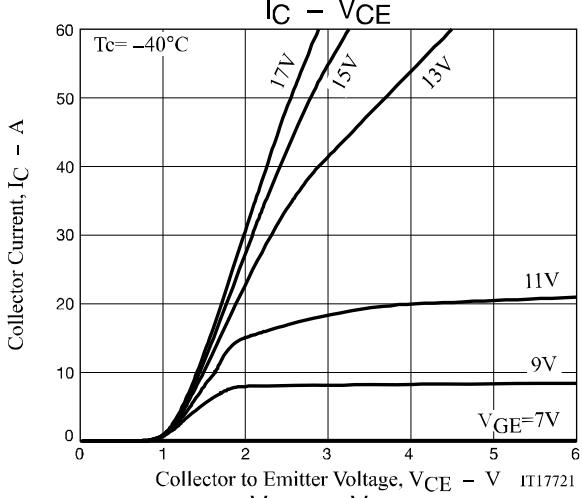
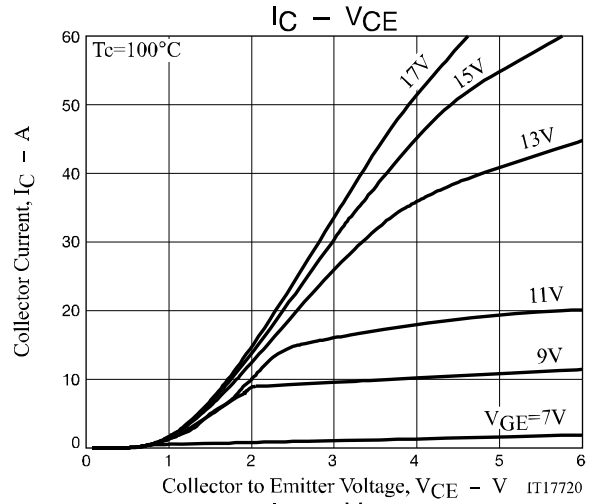
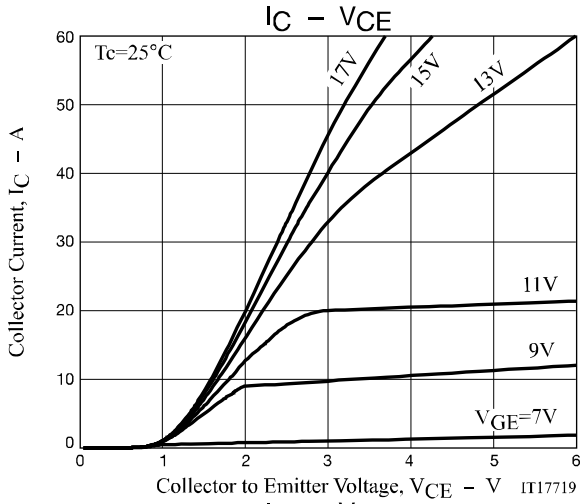

NGTB15N60R2FG

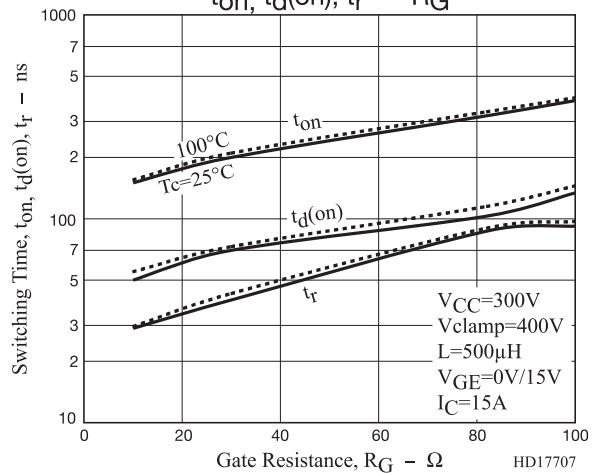
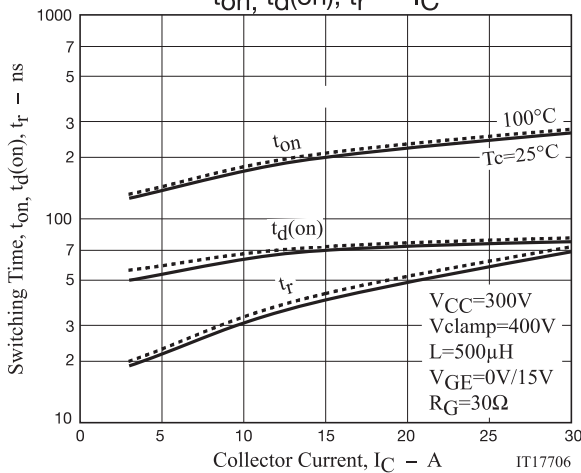
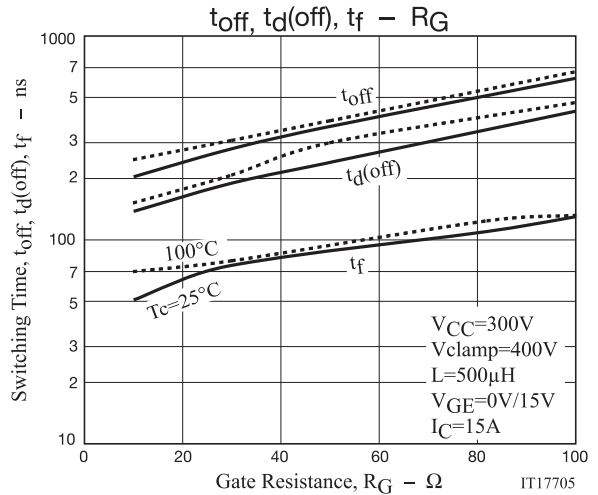
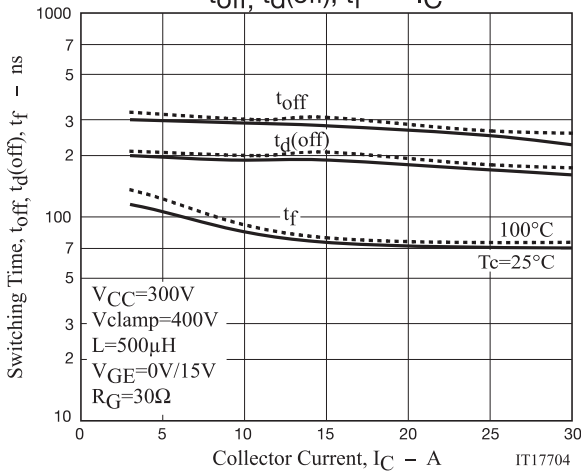
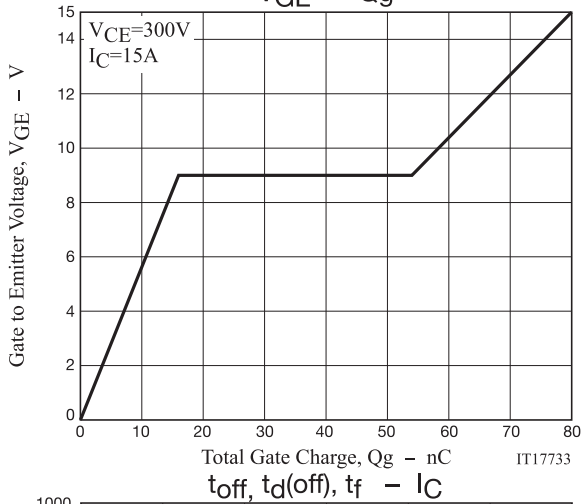
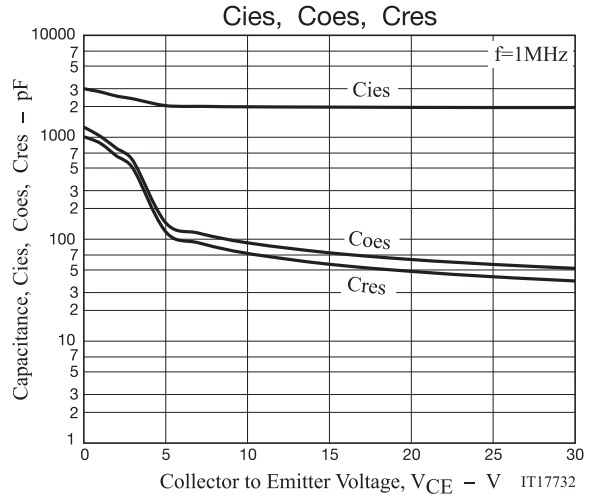
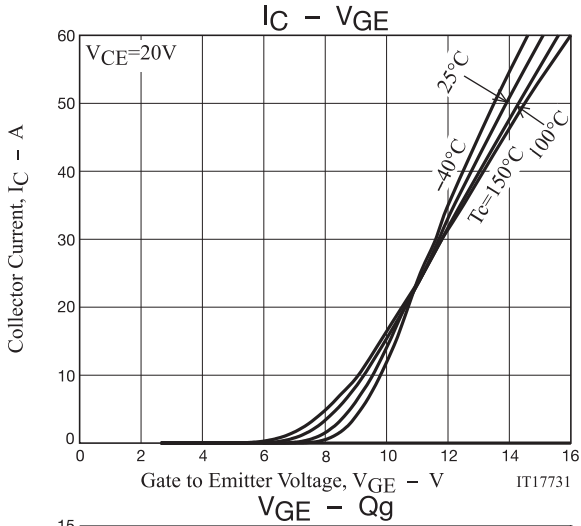

NGTB15N60R2FG

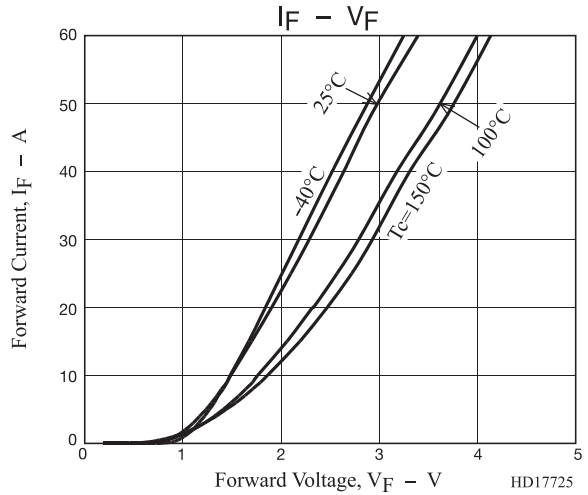
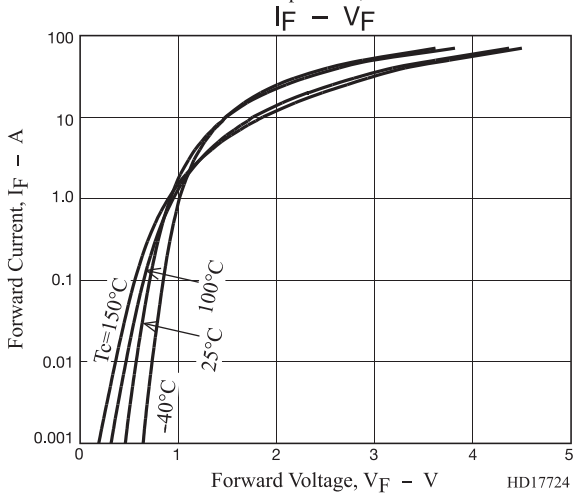
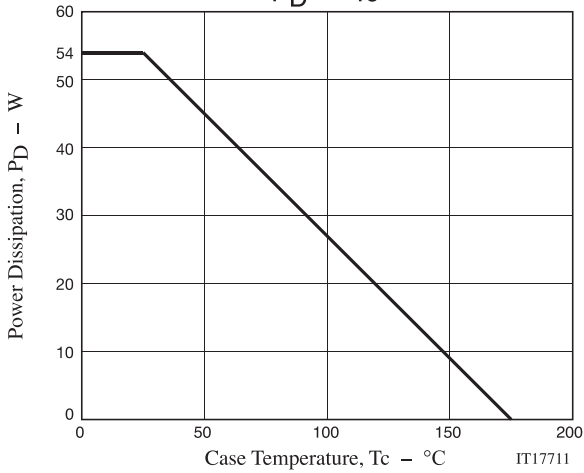
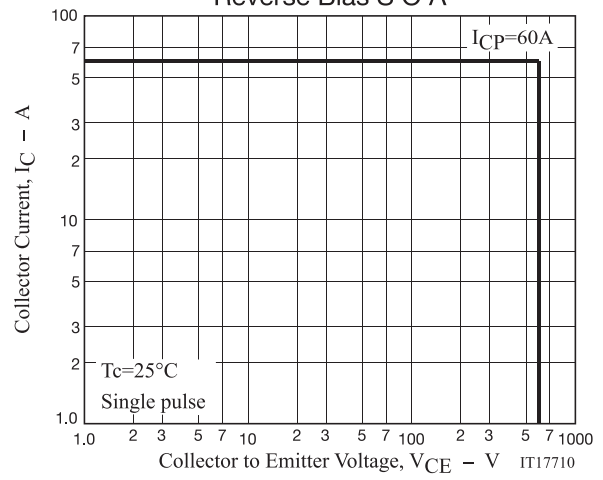
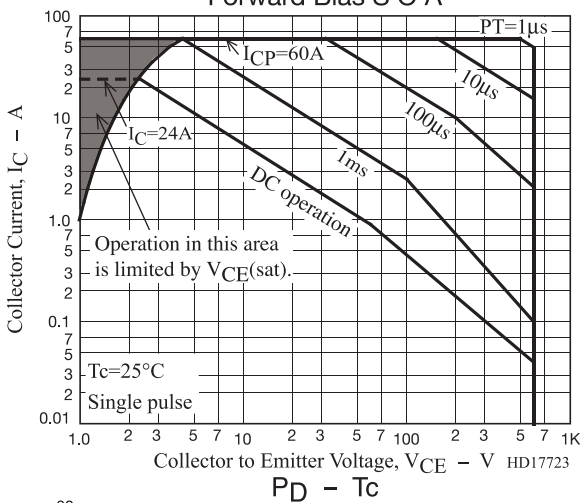
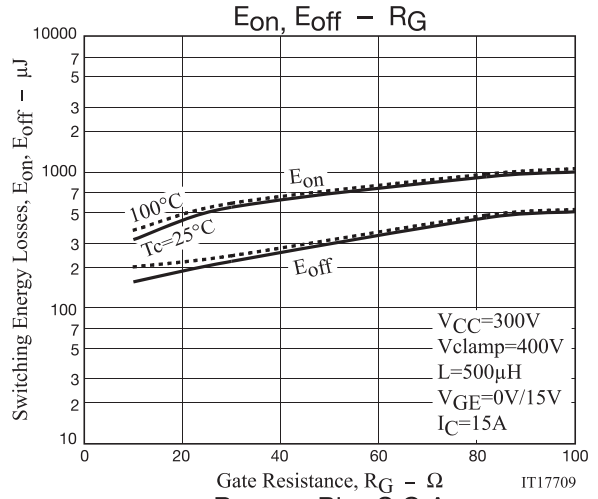
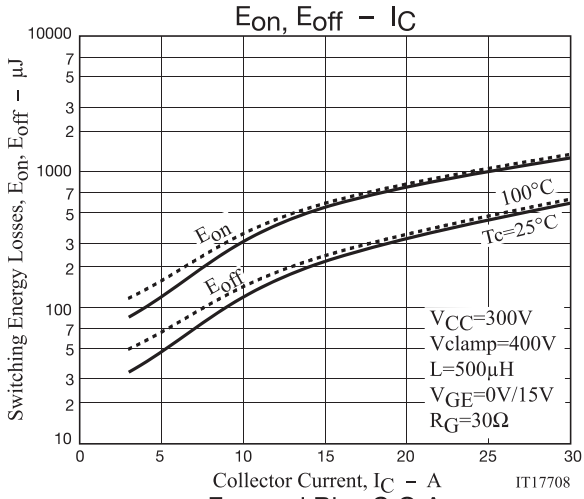

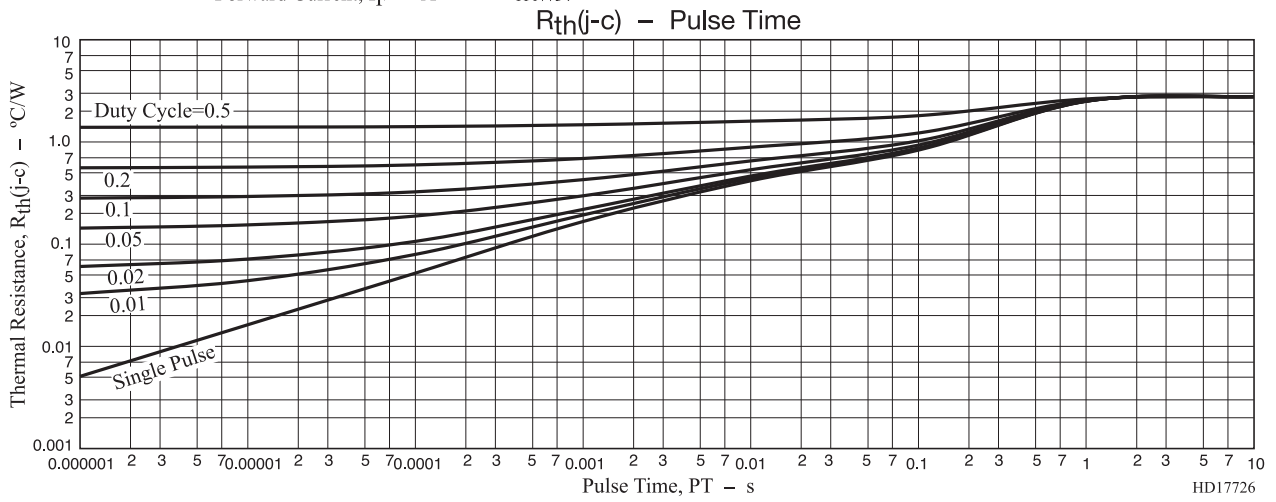
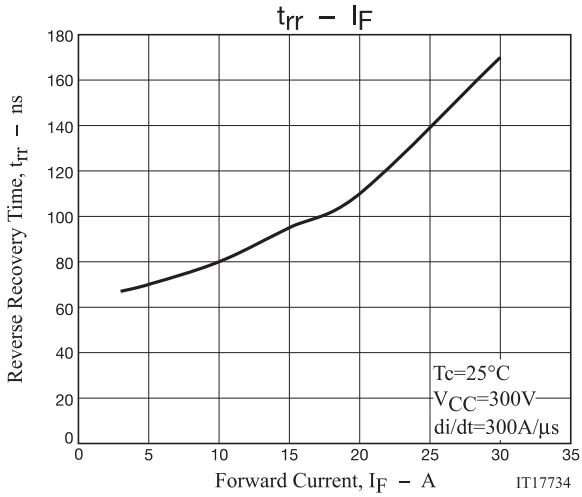

Fig.1 Switching Time Test Circuit

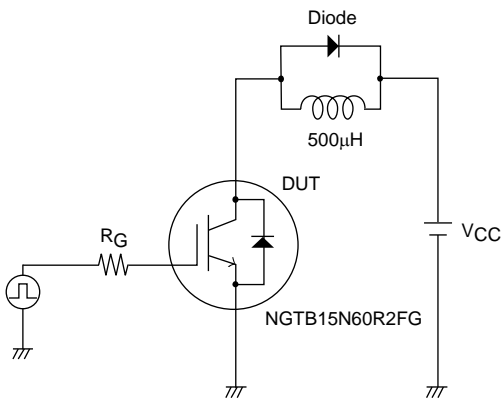

Fig.2 Timing Chart

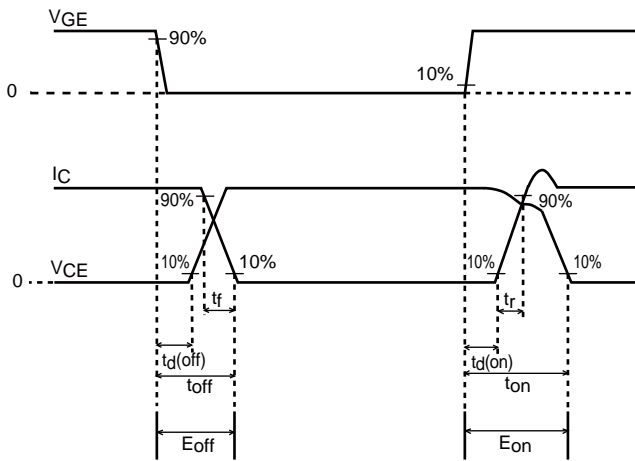
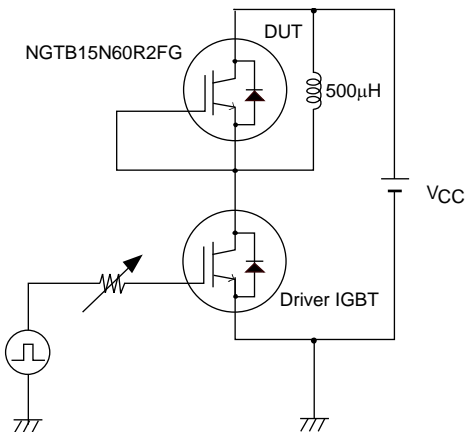

Fig.3 Reverse Recovery Time Test Circuit



NGTB15N60R2FG

Package Dimensions

NGTB15N60R2FG

TO-220F-3FS

CASE 221AM

ISSUE O

unit : mm

1:Gate

2:Collector

3:Emitter

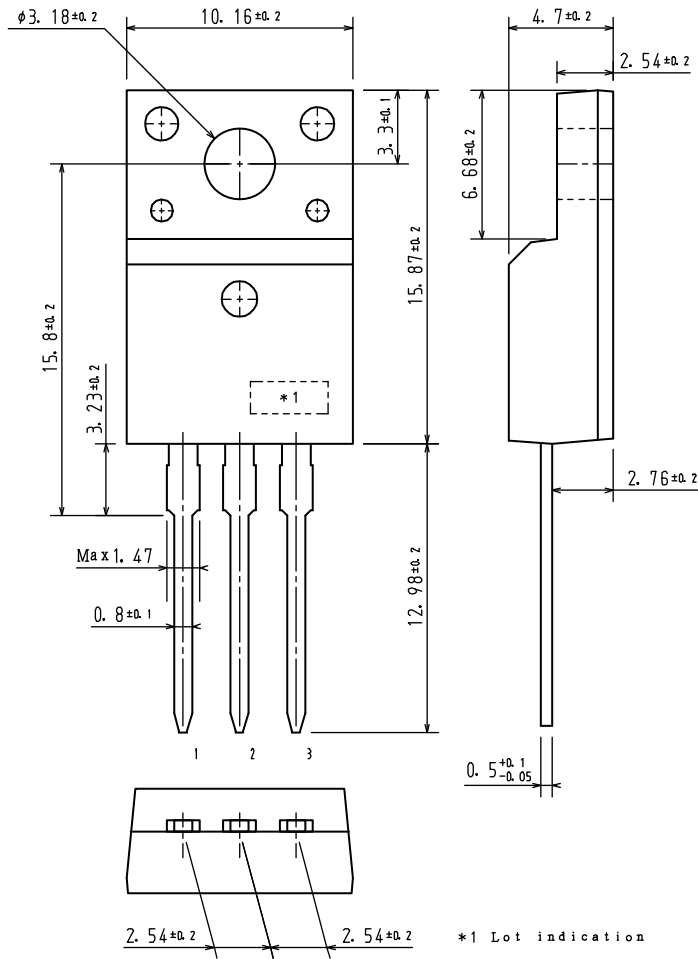

ORDERING INFORMATION

Device	Package	Shipping	note
NGTB15N60R2FG	TO-220F-3FS	50 pcs. / tube	Pb-Free and Halogen Free

ON Semiconductor and the ON logo are registered trademarks of Semiconductor Components Industries, LLC (SCILLC) or its subsidiaries in the United States and/or other countries. SCILLC owns the rights to a number of patents, trademarks, copyrights, trade secrets, and other intellectual property. A listing of SCILLC's product/patent coverage may be accessed at www.onsemi.com/site/pdf/Patent-Marking.pdf. SCILLC reserves the right to make changes without further notice to any products herein. SCILLC makes no warranty, representation or guarantee regarding the suitability of its products for any particular purpose, nor does SCILLC assume any liability arising out of the application or use of any product or circuit, and specifically disclaims any and all liability, including without limitation special, consequential or incidental damages. "Typical" parameters which may be provided in SCILLC data sheets and/or specifications can and do vary in different applications and actual performance may vary over time. All operating parameters, including "Typicals" must be validated for each customer application by customer's technical experts. SCILLC does not convey any license under its patent rights nor the rights of others. SCILLC products are not designed, intended, or authorized for use as components in systems intended for surgical implant into the body, or other applications intended to support or sustain life, or for any other application in which the failure of the SCILLC product could create a situation where personal injury or death may occur. Should Buyer purchase or use SCILLC products for any such unintended or unauthorized application, Buyer shall indemnify and hold SCILLC and its officers, employees, subsidiaries, affiliates, and distributors harmless against all claims, costs, damages, and expenses, and reasonable attorney fees arising out of, directly or indirectly, any claim of personal injury or death associated with such unintended or unauthorized use, even if such claim alleges that SCILLC was negligent regarding the design or manufacture of the part. SCILLC is an Equal Opportunity/Affirmative Action Employer. This literature is subject to all applicable copyright laws and is not for resale in any manner.