

# NCV8537

## 500 mA High Accuracy Low Dropout Linear Regulator, with Power Good Function

The NCV8537 is a high performance low dropout linear voltage regulator. Based on the popular NCV8535, the device retains all the best features of its predecessor which includes high accuracy, excellent stability, low noise performance and reverse bias protection but now includes a Power Good output signal to enable monitoring of the supply system. The device is available with fixed or adjustable outputs and is packaged in a 10 pin 3x3 mm DFN package.

### Features

- High Accuracy Output Over Line and Load Variances ( $\pm 0.9\%$  at  $25^{\circ}\text{C}$ )
- Operating Temperature Range:  $-40^{\circ}\text{C}$  to  $125^{\circ}\text{C}$
- Power Good Output to Indicate the Regulator is Within Specified Limits
- Stable Output with Low Value Capacitors of any type and with no Minimum Load Current Requirement
- Incorporates Current Limiting and Reverse Bias Protection
- Thermal Shutdown Protection
- Low Dropout Voltage at Full Load (340 mV typ at  $V_o = 3.3\text{ V}$ )
- Low Noise (33  $\mu\text{Vrms}$  w/ 10 nF  $C_{nr}$  and 52  $\mu\text{Vrms}$  w/out  $C_{nr}$ )
- Low Shutdown Current ( $< 1\text{ mA}$ )
- Reverse Bias Protected
- 2.9 V to 12 V Supply Range
- Available in 1.8 V, 2.5 V, 3.3 V, 5.0 V and Adjustable Output Voltages
- NCV Prefix for Automotive and Other Applications Requiring Unique Site and Control Change Requirements; AEC-Q100 Qualified and PPAP Capable
- These are Pb-Free Devices

### Applications

- Networking Systems, DSL/Cable Modems
- Audio Systems for Automotive Applications
- Navigation Systems
- Satellite Receivers



ON Semiconductor®

[www.onsemi.com](http://www.onsemi.com)



DFN10  
MN SUFFIX  
CASE 485C

### PIN CONFIGURATION

Pin 1, 2.  $V_{out}$   
3. Sense / ADJ  
4. GND  
5. PWRG  
6. NC  
7. NR  
8.  $\overline{SD}$   
9, 10.  $V_{in}$   
EP, GND

### MARKING DIAGRAM

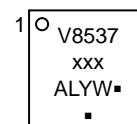

xxx = Specific Device Marking  
A = Assembly Location  
L = Wafer Lot  
Y = Year  
W = Work Week  
▪ = Pb-Free Package

(Note: Microdot may be in either location)

### ORDERING INFORMATION

See detailed ordering, marking and shipping information in the package dimensions section on page 15 of this data sheet.

This document contains information on some products that are still under development. ON Semiconductor reserves the right to change or discontinue these products without notice.

# NCV8537

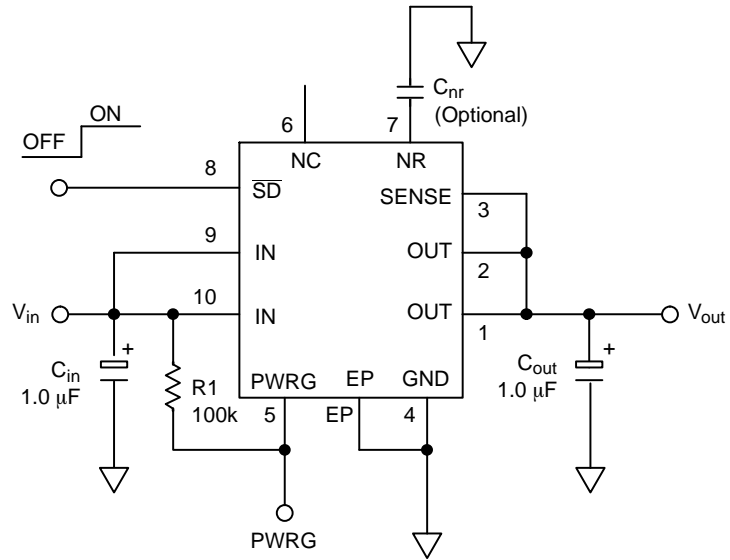

Figure 1. Typical Fixed Version Application Schematic

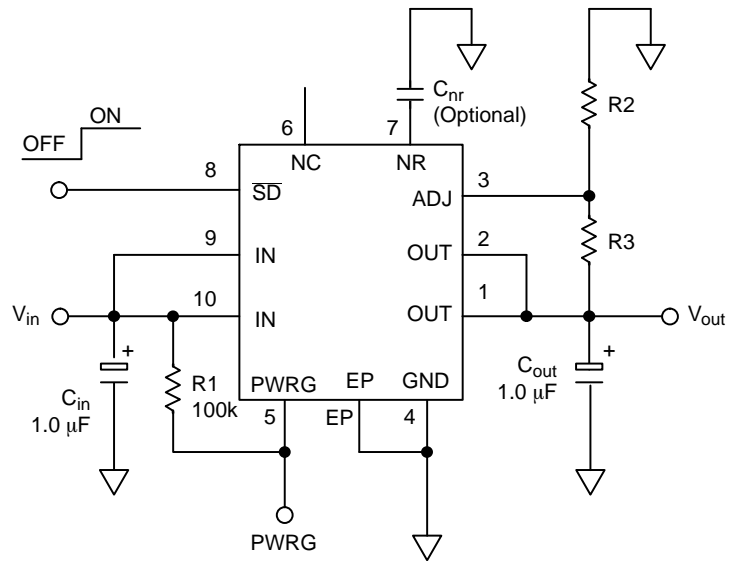

Figure 2. Typical Adjustable Version Application Schematic

# NCV8537

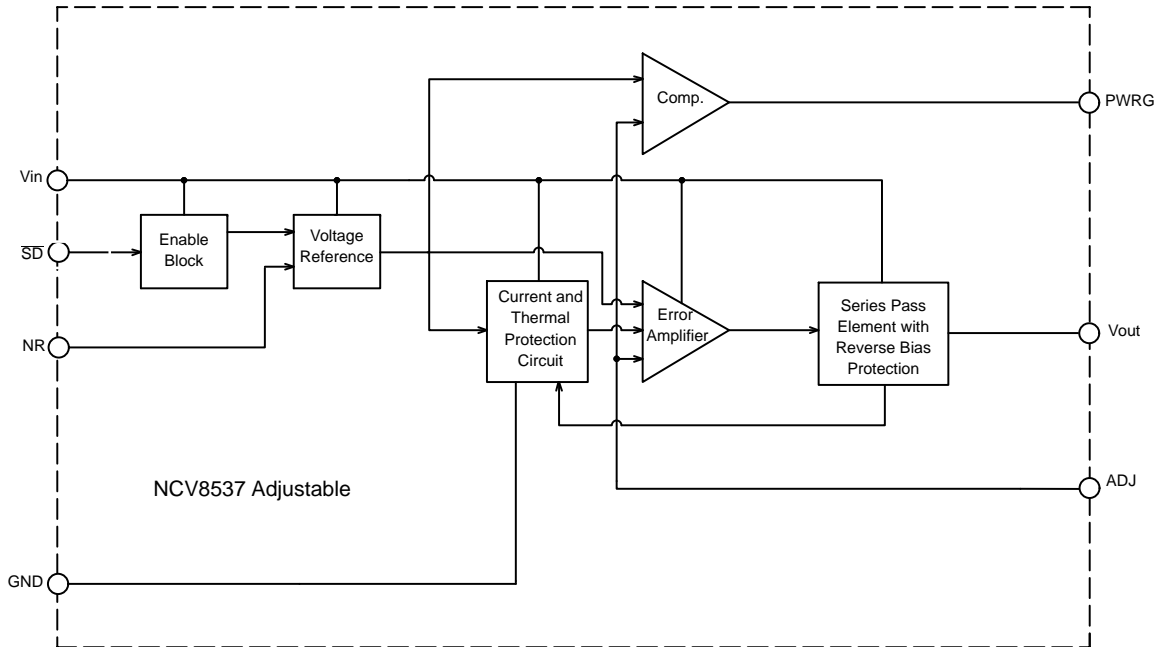

Figure 3. Block Diagram, Adjustable Output Version

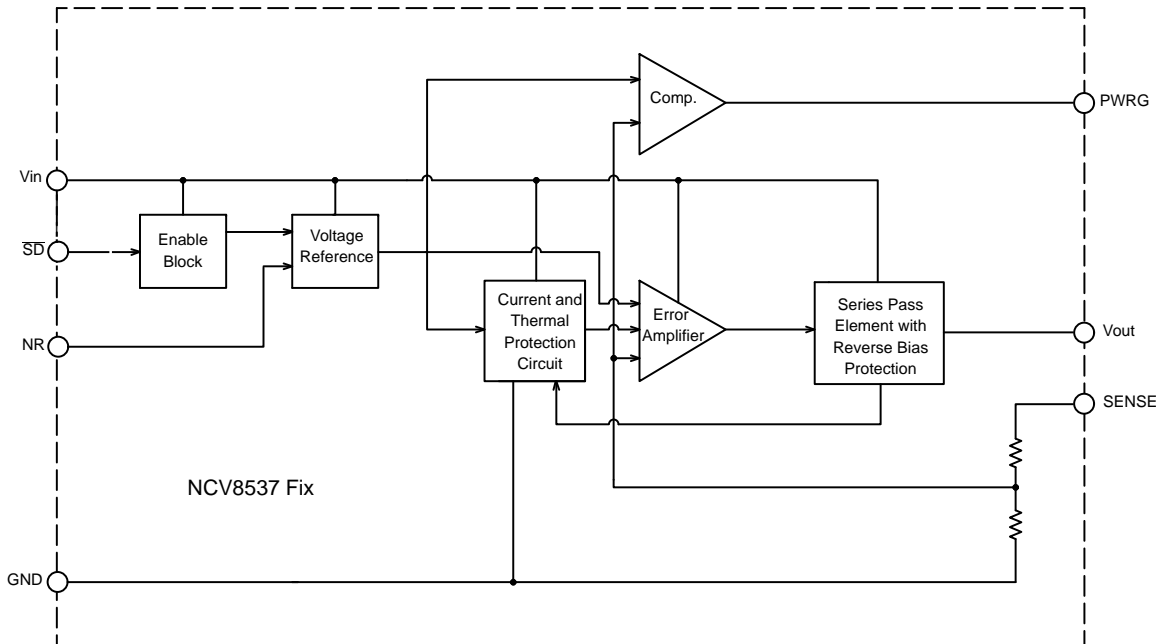

Figure 4. Block Diagram, Fixed Output Version

# NCV8537

## PIN FUNCTION DESCRIPTION

| Pin No. | Pin Name         | Description   |
|---------|------------------|---|
| 1, 2    | V <sub>out</sub> | Regulated output voltage. Bypass to ground with C <sub>out</sub> ≥ 1.0 μF   |
| 3       | SENSE/ADJ        | For output voltage sensing, connect to Pins 1 and 2. at Fixed output Voltage version<br>Adjustable pin at Adjustable output version |
| 4       | GND              | Power Supply Ground   |
| 5       | PWRG             | Power Good  |
| 6       | NC               | Not Connected   |
| 7       | NR               | Noise Reduction Pin. This is an optional pin used to further reduce noise.  |
| 8       | $\overline{SD}$  | Shutdown pin. When not in use, this pin should be connected to the input pin.   |
| 9, 10   | V <sub>in</sub>  | Power Supply Input Voltage  |
| EPAD    | EPAD             | Exposed thermal pad should be connected to ground.  |

## MAXIMUM RATINGS

| Rating                     | Symbol            | Value                                 | Unit |
|----------------------------|-------------------|---------------------------------------|------|
| Input Voltage              | V <sub>in</sub>   | -0.3 to +16                           | V    |
| Output Voltage             | V <sub>out</sub>  | -0.3 to V <sub>in</sub> +0.3 or 10 V* | V    |
| PWRG Pin Voltage           | V <sub>PWRG</sub> | -0.3 to +16                           | V    |
| Shutdown Pin Voltage       | V <sub>sh</sub>   | -0.3 to +16                           | V    |
| Junction Temperature Range | T <sub>J</sub>    | -40 to +150                           | °C   |
| Storage Temperature Range  | T <sub>stg</sub>  | -50 to +150                           | °C   |

Stresses exceeding those listed in the Maximum Ratings table may damage the device. If any of these limits are exceeded, device functionality should not be assumed, damage may occur and reliability may be affected.

NOTE: This device series contains ESD protection and exceeds the following tests:  
 Human Body Model (HBM) tested per AEC-Q100-002 (EIA/JESD22-A114)  
 Machine Model (MM) tested per AEC-Q100-003 (EIA/JESD22-A115)  
 Charged Device Model (CDM) tested per EIA/JESD22-C101.

\*Which ever is less. Reverse bias protection feature valid only if (V<sub>out</sub> - V<sub>in</sub>) ≤ 7 V.

## THERMAL CHARACTERISTICS

| Characteristic                   | Test Conditions (Typical Value) |                       | Unit |
|----------------------------------|---------------------------------|-----------------------|------|
|                                  | Min Pad Board (Note 1)          | 1" Pad Board (Note 1) |      |
| Junction-to-Air, θ <sub>JA</sub> | 215                             | 66                    | °C/W |
| Junction-to-Pin, J-L4            | 58                              | 18                    | °C/W |

1. As mounted on a 35 x 35 x 1.5 mm FR4 Substrate, with a single layer of a specified copper area of 2 oz (0.07 mm thick) copper traces and heat spreading area. JEDEC 51 specifications for a low and high conductivity test board recommend a 2 oz copper thickness. Test conditions are under natural convection or zero air flow.

**ELECTRICAL CHARACTERISTICS – 1.8 V**

( $V_{out} = 1.8 \text{ V}$  typical,  $V_{in} = 2.9 \text{ V}$ ,  $T_A = -40^\circ\text{C}$  to  $+125^\circ\text{C}$ , unless otherwise noted, Note 2)

| Characteristic  | Symbol   | Min            | Typ                    | Max                     | Unit  |
|---|--|----------------|------------------------|-------------------------|---|
| Output Voltage (Accuracy)<br>$V_{in} = 2.9 \text{ V}$ to $5.8 \text{ V}$ , $I_{load} = 0.1 \text{ mA}$ to $500 \text{ mA}$ , $T_A = 25^\circ\text{C}$   | $V_{out}$  | -0.9%<br>1.783 | 1.8                    | +0.9%<br>1.817          | V   |
| Output Voltage (Accuracy)<br>$V_{in} = 2.9 \text{ V}$ to $5.8 \text{ V}$ , $I_{load} = 0.1 \text{ mA}$ to $500 \text{ mA}$ , $T_A = 0^\circ\text{C}$ to $+85^\circ\text{C}$   | $V_{out}$  | -1.4%<br>1.774 | 1.8                    | +1.4%<br>1.826          | V   |
| Output Voltage (Accuracy)<br>$V_{in} = 2.9 \text{ V}$ to $5.8 \text{ V}$ , $I_{load} = 0.1 \text{ mA}$ to $500 \text{ mA}$ , $T_A = -40^\circ\text{C}$ to $+125^\circ\text{C}$  | $V_{out}$  | -1.5%<br>1.773 | 1.8                    | +1.5%<br>1.827          | V   |
| Minimum Input Voltage   | $V_{inmin}$                                      |                | 2.9                    |                         | V   |
| Line Regulation<br>$V_{in} = 2.9 \text{ V}$ to $12 \text{ V}$ , $I_{load} = 0.1 \text{ mA}$   | LineReg  |                | 0.04                   |                         | mV/V  |
| Load Regulation<br>$V_{in} = 2.9 \text{ V}$ , $I_{load} = 0.1 \text{ mA}$ to $500 \text{ mA}$   | LoadReg  |                | 0.04                   |                         | mV/mA                                       |
| Dropout Voltage (See Figure 9)<br>$I_{load} = 500 \text{ mA}$ (Notes 3, 4)<br>$I_{load} = 300 \text{ mA}$ (Notes 3, 4)<br>$I_{load} = 50 \text{ mA}$ (Notes 3, 4)   | $V_{DO}$   |                | 620<br>230<br>95       |                         | mV  |
| Peak Output Current (See Figures 14 and 17)   | $I_{pk}$   | 500            | 700                    | 830                     | mA  |
| Short Output Current (See Figure 14) $V_{in} < 7 \text{ V}$ , $T_A = 25^\circ\text{C}$  | $I_{sc}$   |                |                        | 900                     | mA  |
| Thermal Shutdown / Hysteresis   | $T_J$  |                | 160/10                 |                         | $^\circ\text{C}$                            |
| Ground Current<br>In Regulation<br>$I_{load} = 500 \text{ mA}$ (Note 3)<br>$I_{load} = 300 \text{ mA}$ (Note 3)<br>$I_{load} = 50 \text{ mA}$<br>$I_{load} = 0.1 \text{ mA}$<br><br>In Dropout<br>$V_{in} = 2.2 \text{ V}$ , $I_{load} = 0.1 \text{ mA}$<br><br>In Shutdown<br>$V_{SD} = 0 \text{ V}$ | $I_{GND}$<br><br><br><br><br><br><br>$I_{GNDsh}$ |                | 9.0<br>4.6<br>0.8<br>– | 14<br>7.5<br>2.5<br>220 | mA<br><br><br><br><br><br><br>$\mu\text{A}$ |
| Output Noise<br>$C_{nr} = 0 \text{ nF}$ , $I_{load} = 500 \text{ mA}$ , $f = 10 \text{ Hz}$ to $100 \text{ kHz}$ , $C_{out} = 10 \mu\text{F}$<br>$C_{nr} = 10 \text{ nF}$ , $I_{load} = 500 \text{ mA}$ , $f = 10 \text{ Hz}$ to $100 \text{ kHz}$ , $C_{out} = 10 \mu\text{F}$                       | $V_{noise}$                                      |                | 52<br>33               |                         | $\mu\text{Vrms}$<br>$\mu\text{Vrms}$        |
| Power Good Voltage<br>Low Threshold<br>Hysteresis<br>High Threshold   | $V_{elft}$                                       | 93             | 95<br>2<br>97          | 99                      | % of $V_{out}$                              |
| Power Good Pin Voltage Saturation ( $I_{ef} = 1.0 \text{ mA}$ )   | $V_{efdo}$                                       |                | 200                    |                         | mV  |
| Power Good Pin Leakage  | $I_{efleak}$                                     |                | 1.0                    |                         | $\mu\text{A}$                               |
| Power Good Blanking Time (Note 7)   | $t_{ef}$   |                | 50                     |                         | $\mu\text{s}$                               |
| Shutdown<br>Threshold Voltage ON<br>Threshold Voltage OFF   | $V_{SD}$   | 2.0            |                        | 0.4                     | V<br>V                                      |
| SD Input Current, $V_{SD} = 0 \text{ V}$ to $0.4 \text{ V}$ or $V_{SD} = 2.0 \text{ V}$ to $V_{in}$   | $I_{SD}$   |                | 0.07                   | 1.0                     | $\mu\text{A}$                               |
| Output Current In Shutdown Mode, $V_{out} = 0 \text{ V}$  | $I_{OSD}$  |                | 0.07                   | 1.0                     | $\mu\text{A}$                               |
| Reverse Bias Protection, Current Flowing from the Output Pin to GND<br>( $V_{in} = 0 \text{ V}$ , $V_{out\_forced} = 1.8 \text{ V}$ )   | $I_{OUTR}$                                       |                | 10                     |                         | $\mu\text{A}$                               |

- Performance guaranteed over the operating temperature range by design and/or characterization, production tested at  $T_J = T_A = 25^\circ\text{C}$ . Low duty cycle pulse techniques are used during testing to maintain the junction temperature as close to ambient as possible.
- $T_A$  must be greater than  $0^\circ\text{C}$ .
- Maximum dropout voltage is limited by minimum input voltage  $V_{in} = 2.9 \text{ V}$  recommended for guaranteed operation.

# NCV8537

## ELECTRICAL CHARACTERISTICS – 2.5 V

( $V_{out} = 2.5$  V typical,  $V_{in} = 2.9$  V,  $T_A = -40^{\circ}\text{C}$  to  $+125^{\circ}\text{C}$ , unless otherwise noted, Note 5)

| Characteristic   | Symbol                                       | Min            | Typ                     | Max                     | Unit  |
|--|--|----------------|-------------------------|-------------------------|---|
| Output Voltage (Accuracy)<br>$V_{in} = 2.9$ V to $6.5$ V, $I_{load} = 0.1$ mA to $500$ mA, $T_A = 25^{\circ}\text{C}$  | $V_{out}$                                    | -0.9%<br>2.477 | 2.5                     | +0.9%<br>2.523          | V   |
| Output Voltage (Accuracy)<br>$V_{in} = 2.9$ V to $6.5$ V, $I_{load} = 0.1$ mA to $500$ mA, $T_A = 0^{\circ}\text{C}$ to $+85^{\circ}\text{C}$  | $V_{out}$                                    | -1.4%<br>2.465 | 2.5                     | +1.4%<br>2.535          | V   |
| Output Voltage (Accuracy)<br>$V_{in} = 2.9$ V to $6.5$ V, $I_{load} = 0.1$ mA to $500$ mA, $T_A = -40^{\circ}\text{C}$ to $+125^{\circ}\text{C}$   | $V_{out}$                                    | -1.5%<br>2.462 | 2.5                     | +1.5%<br>2.538          | V   |
| Minimum Input Voltage  | $V_{inmin}$                                  |                | 2.9                     |                         | V   |
| Line Regulation<br>$V_{in} = 2.9$ V to $12$ V, $I_{load} = 0.1$ mA   | LineReg                                      |                | 0.04                    |                         | mV/V  |
| Load Regulation<br>$V_{in} = 2.9$ V, $I_{load} = 0.1$ mA to $500$ mA   | LoadReg                                      |                | 0.04                    |                         | mV/mA   |
| Dropout Voltage (See Figure 10)<br>$I_{load} = 500$ mA (Note 6)<br>$I_{load} = 300$ mA (Note 6)<br>$I_{load} = 50$ mA<br>$I_{load} = 0.1$ mA   | $V_{DO}$                                     |                | 340<br>230<br>110<br>10 |                         | mV  |
| Peak Output Current (See Figures 14 and 18)  | $I_{pk}$                                     | 500            | 700                     | 800                     | mA  |
| Short Output Current (See Figure 14) $V_{in} < 7$ V, $T_A = 25^{\circ}\text{C}$  | $I_{sc}$                                     |                |                         | 900                     | mA  |
| Thermal Shutdown / Hysteresis  | $T_J$  |                | 160/10                  |                         | $^{\circ}\text{C}$  |
| Ground Current<br>In Regulation<br>$I_{load} = 500$ mA (Note 6)<br>$I_{load} = 300$ mA (Note 6)<br>$I_{load} = 50$ mA<br>$I_{load} = 0.1$ mA<br><br>In Dropout<br>$V_{in} = 2.4$ V, $I_{load} = 0.1$ mA<br><br>In Shutdown<br>$V_{SD} = 0$ V | $I_{GND}$<br><br><br><br><br><br>$I_{GNDsh}$ |                | 9.0<br>4.6<br>0.8<br>–  | 14<br>7.5<br>2.5<br>220 | mA<br><br><br>$\mu\text{A}$<br><br>500 $\mu\text{A}$<br><br>1.0 $\mu\text{A}$ |
| Output Noise<br>$C_{nr} = 0$ nF, $I_{load} = 500$ mA, $f = 10$ Hz to $100$ kHz, $C_{out} = 10$ $\mu\text{F}$<br>$C_{nr} = 10$ nF, $I_{load} = 500$ mA, $f = 10$ Hz to $100$ kHz, $C_{out} = 10$ $\mu\text{F}$                                | $V_{noise}$                                  |                | 56<br>35                |                         | $\mu\text{Vrms}$<br>$\mu\text{Vrms}$  |
| Power Good Voltage<br>Low Threshold<br>Hysteresis<br>High Threshold  | $V_{elft}$                                   | 93             | 95<br>2<br>97           | 99                      | % of $V_{out}$  |
| Power Good Pin Voltage Saturation ( $I_{ef} = 1.0$ mA)   | $V_{efdo}$                                   |                | 200                     |                         | mV  |
| Power Good Pin Leakage   | $I_{efleak}$                                 |                | 1.0                     |                         | $\mu\text{A}$   |
| Power Good Blanking Time (Note 7)  | $t_{ef}$                                     |                | 50                      |                         | $\mu\text{s}$   |
| Shutdown<br>Threshold Voltage ON<br>Threshold Voltage OFF  | $V_{SD}$                                     | 2.0            |                         | 0.4                     | V<br>V  |
| $S_D$ Input Current, $V_{SD} = 0$ V to $0.4$ V or $V_{SD} = 2.0$ V to $V_{in}$   | $I_{SD}$                                     |                | 0.07                    | 1.0                     | $\mu\text{A}$   |
| Output Current In Shutdown Mode, $V_{out} = 0$ V   | $I_{OSD}$                                    |                | 0.07                    | 1.0                     | $\mu\text{A}$   |
| Reverse Bias Protection, Current Flowing from the Output Pin to GND<br>( $V_{in} = 0$ V, $V_{out\_forced} = 2.5$ V)  | $I_{OUTR}$                                   |                | 10                      |                         | $\mu\text{A}$   |

5. Performance guaranteed over the operating temperature range by design and/or characterization, production tested at  $T_J = T_A = 25^{\circ}\text{C}$ . Low duty cycle pulse techniques are used during testing to maintain the junction temperature as close to ambient as possible.

6.  $T_A$  must be greater than  $0^{\circ}\text{C}$ .

7. Can be disabled per customer request.

**ELECTRICAL CHARACTERISTICS – 3.3 V**

( $V_{out} = 3.3\text{ V}$  typical,  $V_{in} = 3.7\text{ V}$ ,  $T_A = -40^\circ\text{C}$  to  $+125^\circ\text{C}$ , unless otherwise noted, Note 8)

| Characteristic  | Symbol                                       | Min             | Typ                     | Max                                 | Unit   |
|---|--|-----------------|-------------------------|-------------------------------------|--|
| Output Voltage (Accuracy) $V_{in}$<br>$V_{in} = 3.7\text{ V}$ to $7.3\text{ V}$ , $I_{load} = 0.1\text{ mA}$ to $500\text{ mA}$ , $T_A = 25^\circ\text{C}$  | $V_{out}$                                    | -0.90%<br>3.27  | 3.3                     | 0.90%<br>3.33                       | V  |
| Output Voltage (Accuracy)<br>$V_{in} = 3.7\text{ V}$ to $7.3\text{ V}$ , $I_{load} = 0.1\text{ mA}$ to $500\text{ mA}$ , $T_A = 0^\circ\text{C}$ to $+85^\circ\text{C}$   | $V_{out}$                                    | -1.40%<br>3.254 | 3.3                     | 1.40%<br>3.346                      | V  |
| Output Voltage (Accuracy)<br>$V_{in} = 3.7\text{ V}$ to $7.3\text{ V}$ , $I_{load} = 0.1\text{ mA}$ to $500\text{ mA}$ , $T_A = -40^\circ\text{C}$ to $+125^\circ\text{C}$  | $V_{out}$                                    | -1.50%<br>3.25  | 3.3                     | 1.50%<br>3.35                       | V  |
| Line Regulation<br>$V_{in} = 3.7\text{ V}$ to $12\text{ V}$ , $I_{load} = 0.1\text{ mA}$  | LineReg                                      |                 | 0.04                    |                                     | mV/V   |
| Load Regulation<br>$V_{in} = 3.7\text{ V}$ , $I_{load} = 0.1\text{ mA}$ to $500\text{ mA}$  | LoadReg                                      |                 | 0.04                    |                                     | mV/mA  |
| Dropout Voltage<br>$I_{load} = 500\text{ mA}$<br>$I_{load} = 300\text{ mA}$<br>$I_{load} = 50\text{ mA}$<br>$I_{load} = 0.1\text{ mA}$  | $V_{DO}$                                     |                 | 340<br>230<br>110<br>10 |                                     | mV   |
| Peak Output Current (See Figure 14)   | $I_{pk}$                                     | 500             | 700                     | 800                                 | mA   |
| Short Output Current (See Figure 14) $V_{in} < 7\text{ V}$ , $T_A = 25^\circ\text{C}$   | $I_{sc}$                                     |                 |                         | 900                                 | mA   |
| Thermal Shutdown / Hysteresis   | $T_J$  |                 | 160/10                  |                                     | $^\circ\text{C}$   |
| Ground Current<br>In Regulation<br>$I_{load} = 500\text{ mA}$ (Note 8)<br>$I_{load} = 300\text{ mA}$<br>$I_{load} = 50\text{ mA}$<br>$I_{load} = 0.1\text{ mA}$<br>In Dropout<br>$V_{in} = 3.7\text{ V}$ , $I_{load} = 0.1\text{ mA}$<br>In Shutdown<br>$V_{SD} = 0\text{ V}$         | $I_{GND}$<br><br><br><br><br><br>$I_{GNDsh}$ |                 | 9<br>4.6<br>0.8<br>–    | 14<br>7.5<br>2.5<br>220<br>500<br>1 | mA<br><br><br><br><br><br>$\mu\text{A}$<br><br><br><br><br>$\mu\text{A}$ |
| Output Noise<br>$C_{nr} = 0\text{ nF}$ , $I_{load} = 500\text{ mA}$ , $f = 10\text{ Hz}$ to $100\text{ kHz}$ , $C_{out} = 10\text{ }\mu\text{F}$<br>$C_{nr} = 10\text{ nF}$ , $I_{load} = 500\text{ mA}$ , $f = 10\text{ Hz}$ to $100\text{ kHz}$ , $C_{out} = 10\text{ }\mu\text{F}$ | $V_{noise}$                                  |                 | 69<br>46                |                                     | $\mu\text{Vrms}$   |
| Power Good Voltage<br>Low Threshold<br>Hysteresis<br>High Threshold   | $V_{elft}$                                   | 93              | 95<br>2<br>97           | 99                                  | % of $V_{out}$   |
| Power Good Pin Voltage Saturation ( $I_{ef} = 1.0\text{ mA}$ )  | $V_{efdo}$                                   |                 | 200                     |                                     | mV   |
| Power Good Pin Leakage  | $I_{efleak}$                                 |                 | 1                       |                                     | $\mu\text{A}$  |
| Power Good Blanking Time (Note 9)   | $t_{ef}$                                     |                 | 50                      |                                     | $\mu\text{s}$  |
| Shutdown<br>Threshold Voltage ON<br>Threshold Voltage OFF   | $V_{SD}$                                     | 2               |                         | 0.4                                 | V  |
| SD Input Current, $V_{SD} = 0\text{ V}$ to $0.4\text{ V}$ or $V_{SD} = 2.0\text{ V}$ to $V_{in}$  | $I_{SD}$                                     |                 | 0.07                    | 1                                   | $\mu\text{A}$  |
| Output Current In Shutdown Mode, $V_{out} = 0\text{ V}$   | $I_{OSD}$                                    |                 | 0.07                    | 1                                   | $\mu\text{A}$  |
| Reverse Bias Protection, Current Flowing from the Output Pin to GND<br>( $V_{in} = 0\text{ V}$ , $V_{out\_forced} = 3.3\text{ V}$ )   | $I_{OUTR}$                                   |                 | 10                      |                                     | $\mu\text{A}$  |

8. Performance guaranteed over the operating temperature range by design and/or characterization, production tested at  $T_J = T_A = 25^\circ\text{C}$ . Low duty cycle pulse techniques are used during testing to maintain the junction temperature as close to ambient as possible.

9. Can be disabled per customer request.

# NCV8537

## ELECTRICAL CHARACTERISTICS – 5 V

( $V_{out} = 5.0$  V typical,  $V_{in} = 5.4$  V,  $T_A = -40^\circ\text{C}$  to  $+125^\circ\text{C}$ , unless otherwise noted, Note 10)

| Characteristic   | Symbol   | Min             | Typ                  | Max                                 | Unit  |
|--|--|-----------------|----------------------|-------------------------------------|---|
| Output Voltage (Accuracy) $V_{in}$<br>$V_{in} = 5.4$ V to $7.3$ V, $I_{load} = 0.1$ mA to $500$ mA, $T_A = 25^\circ\text{C}$   | $V_{out}$  | -0.90%<br>4.955 | 5                    | 0.90%<br>5.045                      | V   |
| Output Voltage (Accuracy)<br>$V_{in} = 5.4$ V to $7.3$ V, $I_{load} = 0.1$ mA to $500$ mA, $T_A = 0^\circ\text{C}$ to $+85^\circ\text{C}$  | $V_{out}$  | -1.40%<br>4.93  | 5                    | 1.40%<br>5.07                       | V   |
| Output Voltage (Accuracy)<br>$V_{in} = 5.4$ V to $7.3$ V, $I_{load} = 0.1$ mA to $500$ mA, $T_A = -40^\circ\text{C}$ to $+125^\circ\text{C}$   | $V_{out}$  | -1.50%<br>4.925 | 5                    | 1.50%<br>5.075                      | V   |
| Line Regulation<br>$V_{in} = 5.4$ V to $12$ V, $I_{load} = 0.1$ mA   | LineReg  |                 | 0.04                 |                                     | mV/V  |
| Load Regulation<br>$V_{in} = 5.4$ V, $I_{load} = 0.1$ mA to $500$ mA   | LoadReg  |                 | 0.04                 |                                     | mV/mA                                       |
| Dropout Voltage<br>$I_{load} = 500$ mA<br>$I_{load} = 300$ mA<br>$I_{load} = 50$ mA<br>$I_{load} = 0.1$ mA   | $V_{DO}$   |                 |                      | 340<br>230<br>110<br>10             | mV  |
| Peak Output Current (See Figure 14)  | $I_{pk}$   | 500             | 700                  | 830                                 | mA  |
| Short Output Current (See Figure 14) $V_{in} < 7$ V, $T_A = 25^\circ\text{C}$  | $I_{sc}$   |                 |                      | 930                                 | mA  |
| Thermal Shutdown / Hysteresis  | $T_J$  |                 | 160/10               |                                     | $^\circ\text{C}$                            |
| Ground Current<br>In Regulation<br>$I_{load} = 500$ mA (Note 10)<br>$I_{load} = 300$ mA<br>$I_{load} = 50$ mA<br>$I_{load} = 0.1$ mA<br>In Dropout<br>$V_{in} = 3.2$ V, $I_{load} = 0.1$ mA<br>In Shutdown<br>$V_{SD} = 0$ V | $I_{GND}$<br><br><br><br><br><br><br>$I_{GNDsh}$ |                 | 9<br>4.6<br>0.8<br>– | 14<br>7.5<br>2.5<br>220<br>500<br>1 | mA<br><br><br><br><br><br><br>$\mu\text{A}$ |
| Output Noise<br>$C_{nr} = 0$ nF, $I_{load} = 500$ mA, $f = 10$ Hz to $100$ kHz, $C_{out} = 10$ $\mu\text{F}$<br>$C_{nr} = 10$ nF, $I_{load} = 500$ mA, $f = 10$ Hz to $100$ kHz, $C_{out} = 10$ $\mu\text{F}$                | $V_{noise}$                                      |                 | 93<br>58             |                                     | $\mu\text{Vrms}$                            |
| Power Good Voltage<br>Low Threshold<br>Hysteresis<br>High Threshold  | $V_{elft}$                                       | 93              | 95<br>2<br>97        | 99                                  | % of $V_{out}$                              |
| Power Good Pin Voltage Saturation ( $I_{ef} = 1.0$ mA)   | $V_{efdo}$                                       |                 | 200                  |                                     | mV  |
| Power Good Pin Leakage   | $I_{efleak}$                                     |                 | 1                    |                                     | $\mu\text{A}$                               |
| Power Good Blanking Time (Note 11)   | $t_{ef}$   |                 | 50                   |                                     | $\mu\text{s}$                               |
| Shutdown<br>Threshold Voltage ON<br>Threshold Voltage OFF  | $V_{SD}$   | 2               |                      | 0.4                                 | V   |
| SD Input Current, $V_{SD} = 0$ V to $0.4$ V or $V_{SD} = 2.0$ V to $V_{in}$  | $I_{SD}$   |                 | 0.07                 | 1                                   | $\mu\text{A}$                               |
| Output Current In Shutdown Mode, $V_{out} = 0$ V   | $I_{OSD}$  |                 | 0.07                 | 1                                   | $\mu\text{A}$                               |
| Reverse Bias Protection, Current Flowing from the Output Pin to GND<br>( $V_{in} = 0$ V, $V_{out\_forced} = 5$ V)  | $I_{OUTR}$                                       |                 | 10                   |                                     | $\mu\text{A}$                               |

10. Performance guaranteed over the operating temperature range by design and/or characterization, production tested at  $T_J = T_A = 25^\circ\text{C}$ . Low duty cycle pulse techniques are used during testing to maintain the junction temperature as close to ambient as possible.

11. Can be disabled per customer request.



**ELECTRICAL CHARACTERISTICS – ADJUSTABLE**

( $V_{out} = 1.25\text{ V}$  typical,  $V_{in} = 2.9\text{ V}$ ,  $T_A = -40^\circ\text{C}$  to  $+125^\circ\text{C}$ , unless otherwise noted, Note 12)

| Characteristic  | Symbol   | Min             | Typ                     | Max                                 | Unit  |
|---|--|-----------------|-------------------------|-------------------------------------|---|
| Reference Voltage (Accuracy)<br>$V_{in} = 2.9\text{ V}$ to $V_{out} + 4.0\text{ V}$ , $I_{load} = 0.1\text{ mA}$ to $500\text{ mA}$ , $T_A = 25^\circ\text{C}$  | $V_{ref}$  | -0.90%<br>1.239 | 1.25                    | 0.90%<br>1.261                      | V   |
| Reference Voltage (Accuracy)<br>$V_{in} = 2.9\text{ V}$ to $V_{out} + 4.0\text{ V}$ , $I_{load} = 0.1\text{ mA}$ to $500\text{ mA}$ , $T_A = 0^\circ\text{C}$ to $+85^\circ\text{C}$  | $V_{ref}$  | -1.40%<br>1.233 | 1.25                    | 1.40%<br>1.268                      | V   |
| Reference Voltage (Accuracy)<br>$V_{in} = 2.9\text{ V}$ to $V_{out} + 4.0\text{ V}$ , $I_{load} = 0.1\text{ mA}$ to $500\text{ mA}$ , $T_A = -40^\circ\text{C}$ to $+125^\circ\text{C}$   | $V_{ref}$  | -1.50%<br>1.231 | 1.25                    | 1.50%<br>1.269                      | V   |
| Line Regulation<br>$V_{in} = 2.9\text{ V}$ to $12\text{ V}$ , $I_{load} = 0.1\text{ mA}$  | $Line_{Reg}$   |                 | 0.04                    |                                     | mV/V  |
| Load Regulation<br>$V_{in} = 2.9\text{ V}$ to $12\text{ V}$ , $I_{load} = 0.1\text{ mA}$ to $500\text{ mA}$   | $Load_{Reg}$   |                 | 0.04                    |                                     | mV/mA   |
| Dropout Voltage ( $V_{out} = 2.5\text{ V} - 10\text{ V}$ )<br>$I_{load} = 500\text{ mA}$<br>$I_{load} = 300\text{ mA}$<br>$I_{load} = 50\text{ mA}$<br>$I_{load} = 0.1\text{ mA}$   | $V_{DO}$   |                 | 340<br>230<br>110<br>10 |                                     | mV  |
| Peak Output Current (See Figure 14)   | $I_{pk}$   | 500             | 700                     | 830                                 | mA  |
| Short Output Current (See Figure 14) $V_{in} < 7\text{ V}$ , $T_A = 25^\circ\text{C}$<br>$V_{out} \leq 3.3\text{ V}$<br>$V_{out} > 3.3\text{ V}$  | $I_{sc}$   |                 |                         | 900<br>930                          | mA  |
| Thermal Shutdown / Hysteresis   | $T_J$  |                 | 160/<br>10              |                                     | $^\circ\text{C}$                                |
| Ground Current<br>In Regulation<br>$I_{load} = 500\text{ mA}$ (Note 12)<br>$I_{load} = 300\text{ mA}$<br>$I_{load} = 50\text{ mA}$<br>$I_{load} = 0.1\text{ mA}$<br>In Dropout<br>$V_{in} = V_{out} + 0.1\text{ V}$ or $2.9\text{ V}$ (whichever is higher), $I_{load} = 0.1\text{ mA}$<br>In Shutdown<br>$V_{SD} = 0\text{ V}$ | $I_{GND}$<br><br><br><br><br><br><br><br>$I_{GNDsh}$ |                 | 9<br>4.6<br>0.8         | 14<br>7.5<br>2.5<br>220<br>500<br>1 | mA<br><br><br><br><br><br><br><br>$\mu\text{A}$ |
| Output Noise<br>$C_{nr} = 0\text{ nF}$ , $I_{load} = 500\text{ mA}$ , $f = 10\text{ Hz}$ to $100\text{ kHz}$ , $C_{out} = 10\text{ }\mu\text{F}$<br>$C_{nr} = 10\text{ nF}$ , $I_{load} = 500\text{ mA}$ , $f = 10\text{ Hz}$ to $100\text{ kHz}$ , $C_{out} = 10\text{ }\mu\text{F}$   | $V_{noise}$  |                 | 69<br>46                |                                     | $\mu\text{V}_{rms}$                             |
| Power Good Voltage<br>Low Threshold<br>Hysteresis<br>High Threshold   | $V_{elft}$   | 93              | 95<br>2<br>97           | 99                                  | % of $V_{out}$                                  |
| Power Good Pin Voltage Saturation ( $I_{ef} = 1.0\text{ mA}$ )  | $V_{efdo}$   |                 | 200                     |                                     | mV  |
| Power Good Pin Leakage  | $I_{efleak}$   |                 | 1                       |                                     | $\mu\text{A}$                                   |
| Power Good Pin Blanking Time (Note 13)  | $t_{ef}$   |                 | 50                      |                                     | $\mu\text{s}$                                   |
| Shutdown<br>Threshold Voltage ON<br>Threshold Voltage OFF   | $V_{SD}$   | 2               |                         | 0.4                                 | V   |
| SD Input Current, $V_{SD} = 0\text{ V}$ to $0.4\text{ V}$ or $V_{SD} = 2.0\text{ V}$ to $V_{in}$<br>$V_{in} \leq 5.4\text{ V}$<br>$V_{in} > 5.4\text{ V}$   | $I_{SD}$   |                 | 0.07                    | 1<br>5                              | $\mu\text{A}$                                   |
| Output Current In Shutdown Mode, $V_{out} = 0\text{ V}$   | $I_{OSD}$  |                 | 0.07                    | 1                                   | $\mu\text{A}$                                   |
| Reverse Bias Protection, Current Flowing from the Output Pin to GND<br>( $V_{in} = 0\text{ V}$ , $V_{out\_forced} = V_{out}(\text{nom}) \leq 7\text{ V}$ )  | $I_{OUTR}$   |                 | 1                       |                                     | $\mu\text{A}$                                   |

12. Performance guaranteed over the operating temperature range by design and/or characterization, production tested at  $T_J = T_A = 25^\circ\text{C}$ . Low duty cycle pulse techniques are used during testing to maintain the junction temperature as close to ambient as possible.

13. Can be disabled per customer request.

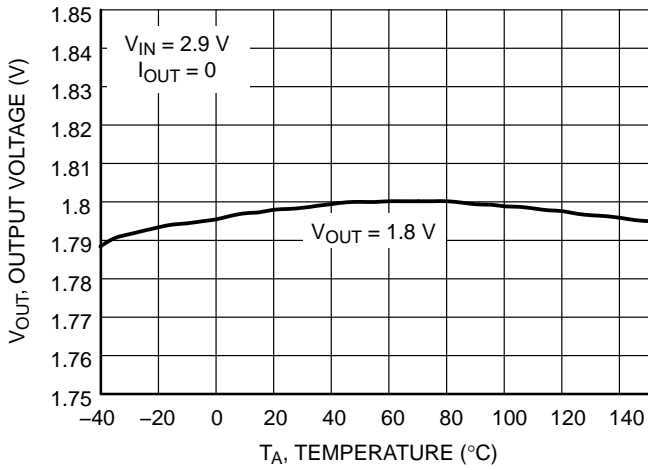

Figure 5. Output Voltage vs. Temperature 1.8 V Version

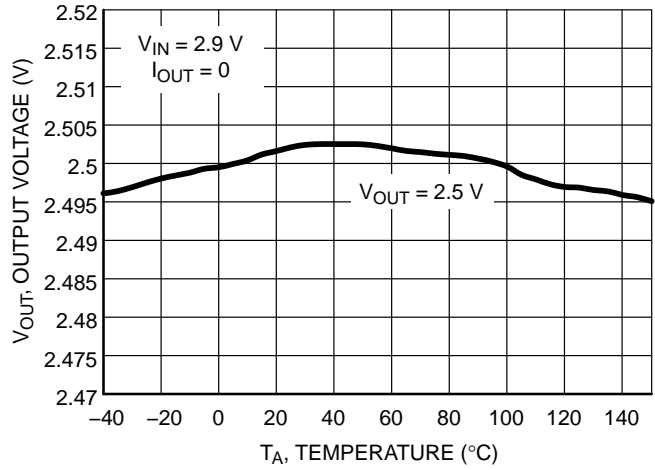

Figure 6. Output Voltage vs. Temperature 2.5 V Version

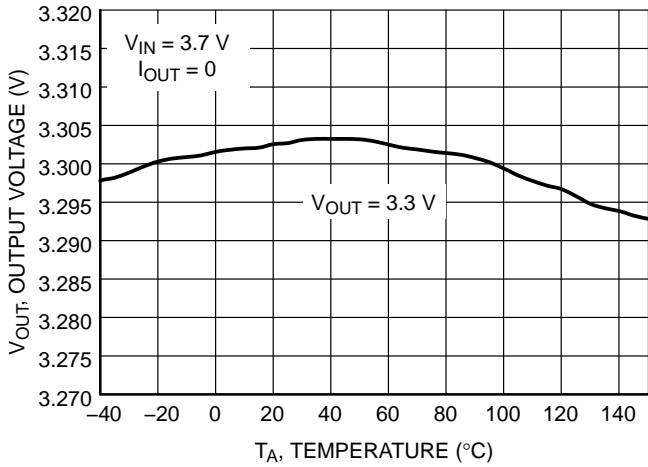

Figure 7. Output Voltage vs. Temperature 3.3 V Version

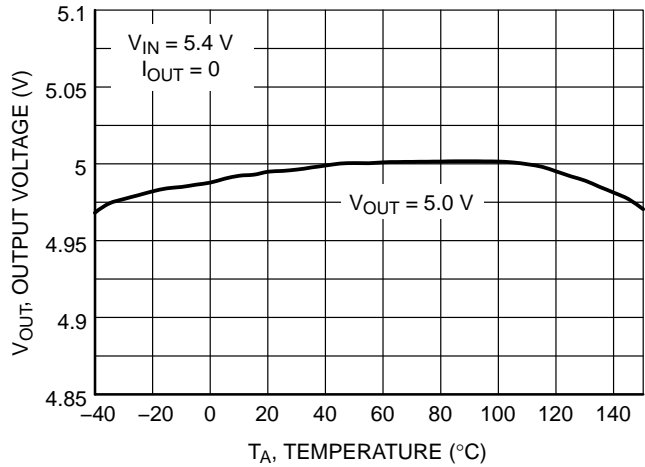

Figure 8. Output Voltage vs. Temperature 5.0 V Version

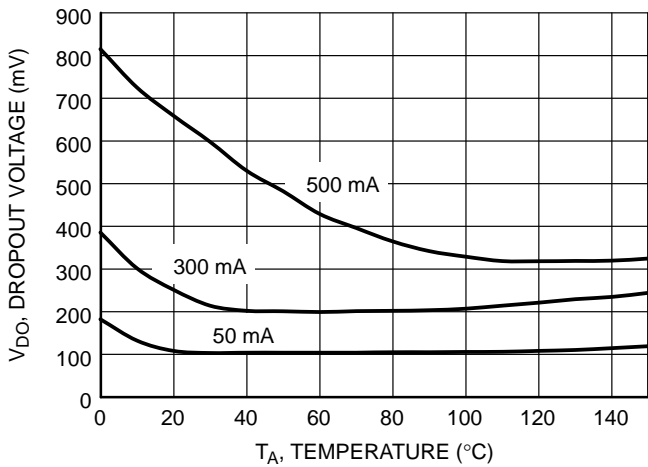

Figure 9. Dropout Voltage vs. Temperature 1.8 V Version

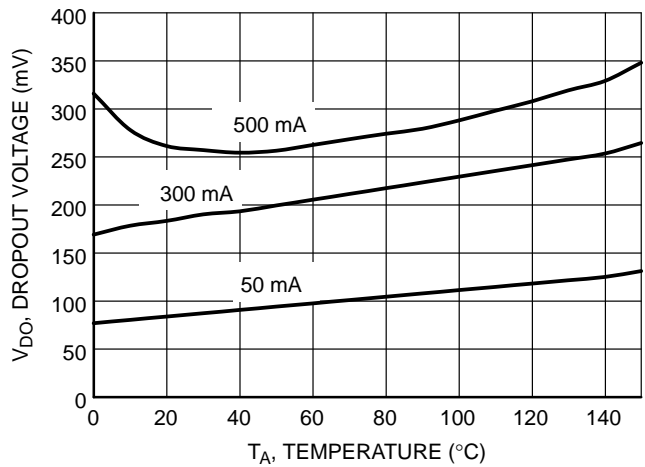

Figure 10. Dropout Voltage vs. Temperature 2.5 V Version

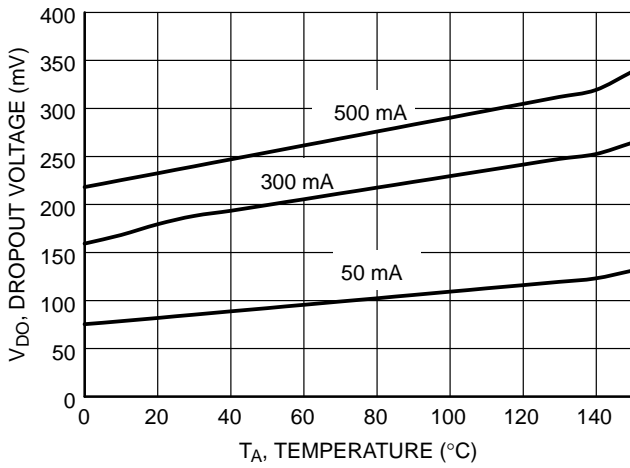

Figure 11. Dropout Voltage vs. Temperature  
3.3 V Version

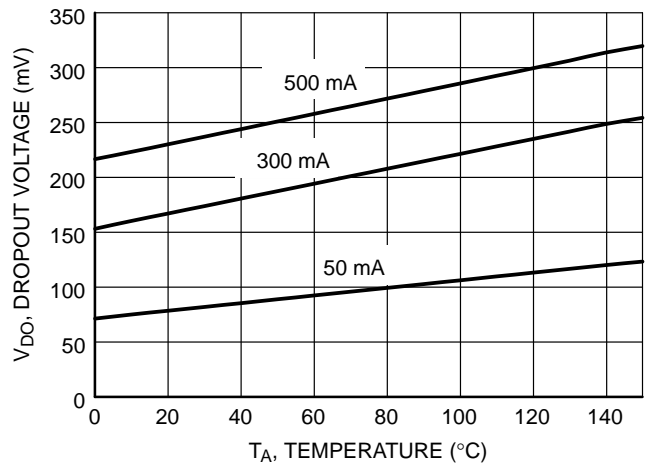

Figure 12. Dropout Voltage vs. Temperature  
5.0 V Version

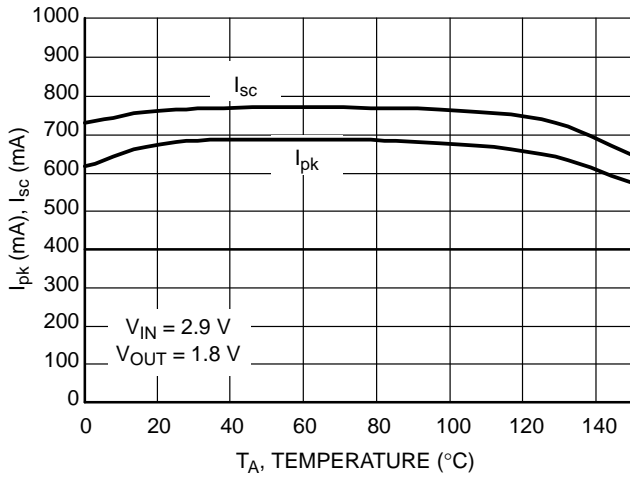
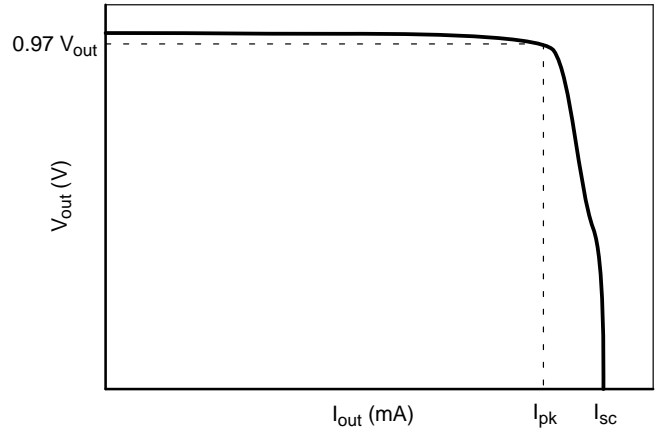

Figure 13. Peak and Short Current  
vs. Temperature



(For specific values of  $I_{pk}$  and  $I_{sc}$ , please refer to Figure 13)

Figure 14. Output Voltage vs. Output Current

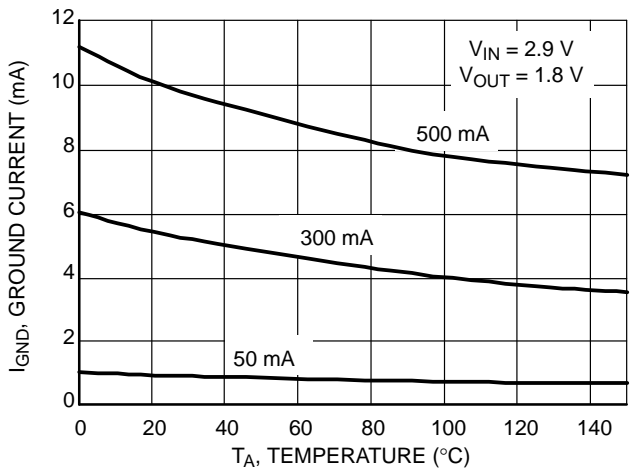

Figure 15. Ground Current vs. Temperature

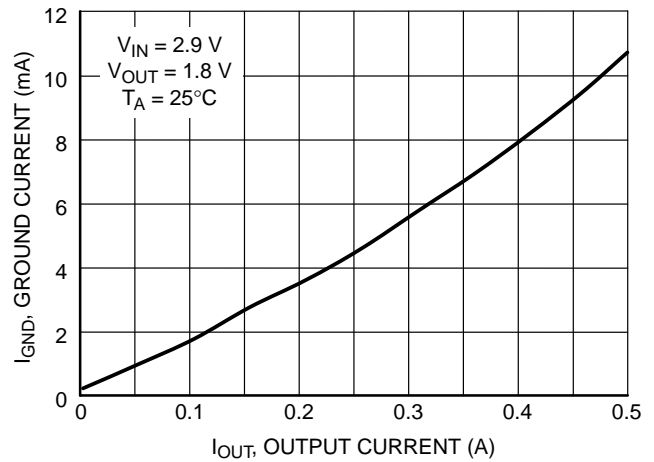

Figure 16. Ground Current vs. Output Current

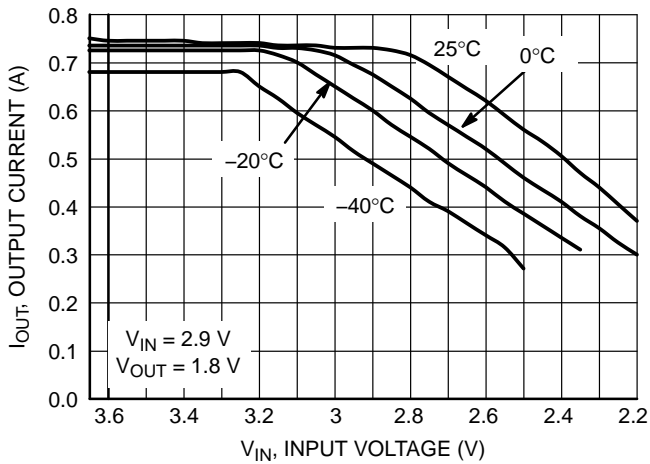

Figure 17. Output Current Capability for the 1.8 V Version

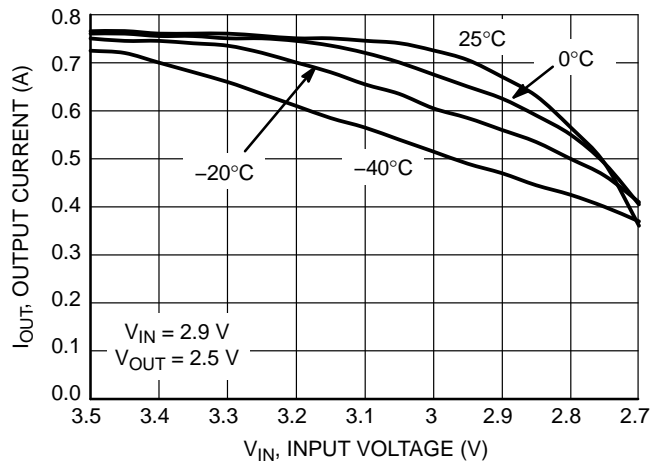

Figure 18. Output Current Capability for the 2.5 V Version

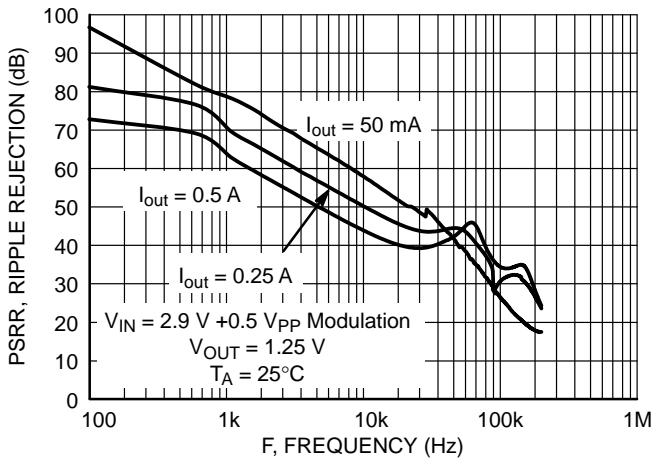

Figure 20. PSRR vs. Frequency Adjustable Version

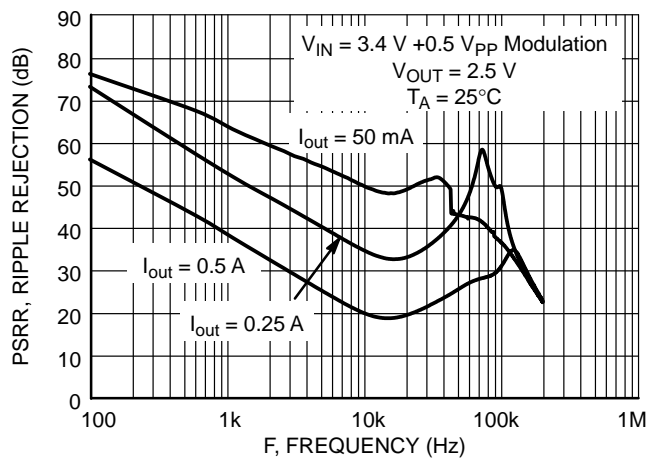

Figure 21. PSRR vs. Frequency 2.5 V Version

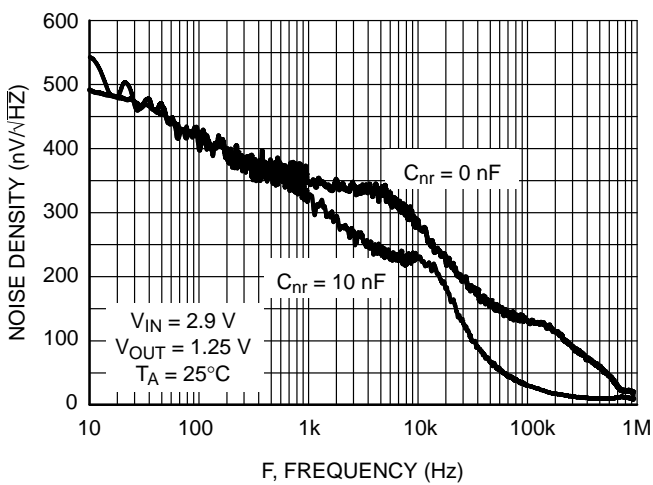

Figure 22. Output Noise Density Adjustable Version

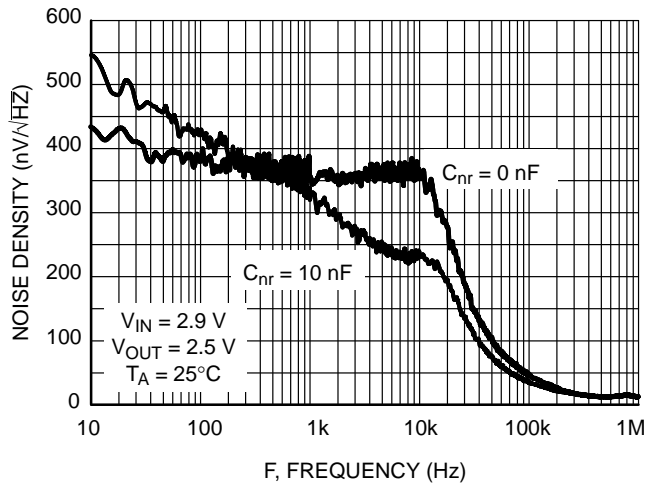

Figure 23. Output Noise Density 2.5 V Version

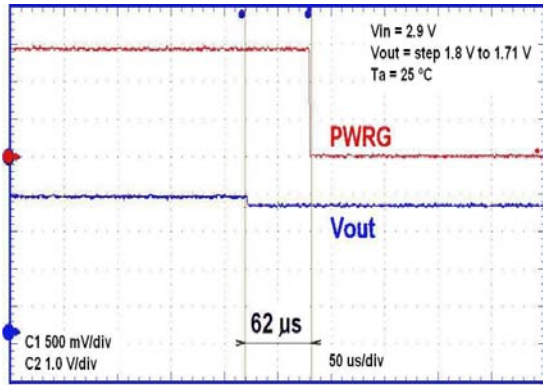

Figure 24. Power Good Activation

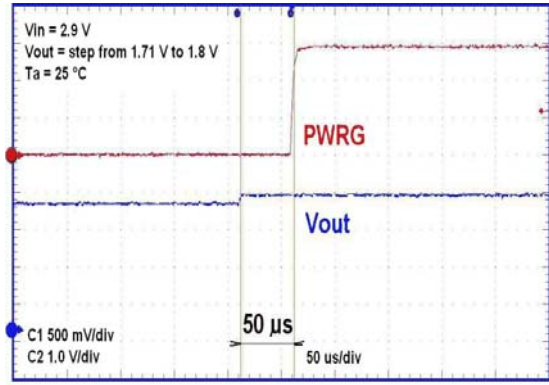

Figure 25. Power Good Inactivation

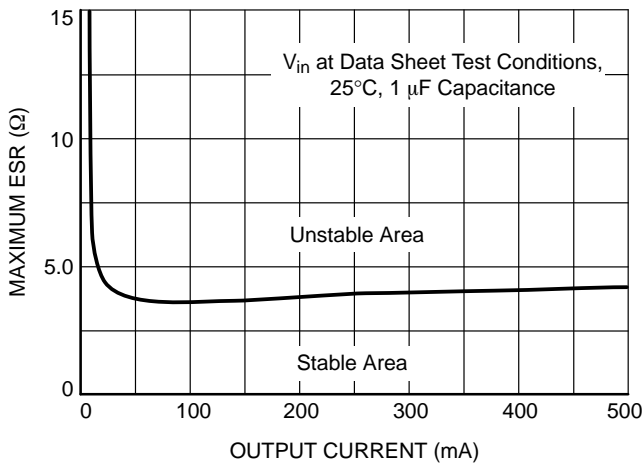

Figure 26. Stability with ESR vs. Output Current

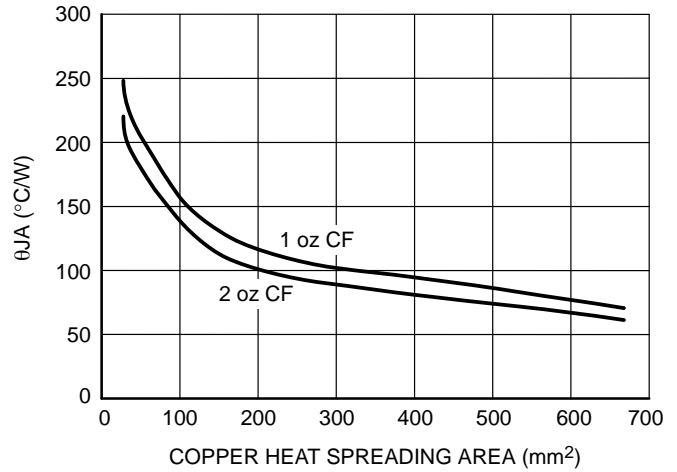

Figure 27. DFN10 Self-Heating Thermal Characteristics as a Function of Copper Area on the PCB

NOTE: Typical characteristics were measured with the same conditions as electrical characteristics.

APPLICATIONS INFORMATION

**Reverse Bias Protection**

Reverse bias is a condition caused when the input voltage goes to zero, but the output voltage is kept high either by a large output capacitor or another source in the application which feeds the output pin.

Normally in a bipolar LDO all the current will flow from the output pin to input pin through the PN junction with limited current capability and with the potential to destroy the IC.

Due to an improved architecture, the NCV8537 can withstand up to 7.0 V on the output pin with virtually no current flowing from output pin to input pin, and only negligible amount of current (tens of  $\mu\text{A}$ ) flowing from the output pin to ground for infinite duration.

**Input Capacitor**

An input capacitor of at least 1.0  $\mu\text{F}$ , any type, is recommended to improve the transient response of the regulator and/or if the regulator is located more than a few inches from the power source. It will also reduce the circuit's sensitivity to the input line impedance at high frequencies. The capacitor should be mounted with the shortest possible track length directly across the regular's input terminals.

**Output Capacitor**

The NCV8537 remains stable with any type of capacitor as long as it fulfills its 1.0  $\mu\text{F}$  requirement. There are no constraints on the minimum ESR and it will remain stable up to an ESR of 5.0  $\Omega$ . Larger capacitor values will improve the noise rejection and load transient response.

**Noise Reduction Pin**

Output noise can be greatly reduced by connecting a 10 nF capacitor ( $C_{nr}$ ) between the noise reduction pin and ground (see Figure 1). In applications where very low noise is not required, the noise reduction pin can be left unconnected.

**Dropout Voltage**

The voltage dropout is measured at 97% of the nominal output voltage.

**Thermal Considerations**

Internal thermal limiting circuitry is provided to protect the integrated circuit in the event that the maximum junction

temperature is exceeded. This feature provides protection from a catastrophic device failure due to accidental overheating. This protection feature is not intended to be used as a substitute to heat sinking. The maximum power that can be dissipated, can be calculated with the equation below:

$$P_D = \frac{T_{J(max)} - T_A}{R_{\theta JA}} \quad (\text{eq. 1})$$

For improved thermal performance, contact the factory for the DFN package option. The DFN package includes an exposed metal pad that is specifically designed to reduce the junction to air thermal resistance,  $R_{\theta JA}$ .

**Adjustable Operation**

The output voltage can be set by using a resistor divider as shown in Figure 2 with a range of 1.25 to 10 V. The appropriate resistor divider can be found by solving the equation below. The recommended current through the resistor divider is from 10  $\mu\text{A}$  to 100  $\mu\text{A}$ . This can be accomplished by selecting resistors in the  $\text{k}\Omega$  range. As result, the  $I_{adj} * R_2$  becomes negligible in the equation and can be ignored.

$$V_{out} = 1.25 * (1 + R_3/R_2) + I_{adj} * R_2 \quad (\text{eq. 2})$$

**Power Good Operation**

The Power Good pin on the NCV8537 will produce a logic Low when it drops below the nominal output voltage. Refer to the electrical characteristics for the threshold values at which point the Power Good goes Low. When the NCV8537 is above the nominal output voltage, the Power Good will remain at logic High.

The external pullup resistor needs to be connected between  $V_{in}$  and the Power Good pin. A resistor of approximately 100  $\text{k}\Omega$  is recommended to minimize the current consumption. No pullup resistor is required if the Power Good output is not being used. The Power Good does not function during thermal shutdown and when the part is disabled.

# NCV8537

## ORDERING INFORMATION

| Device*           | Voltage Option | Marking   | Package            | Package                       | Shipping†          |
|-------------------|----------------|-----------|--------------------|-------------------------------|--------------------|
| NCV8537MN180R2G   | 1.8 V          | V8537 180 | DFN10<br>(Pb-Free) | Non-Wettable<br>Flank         | 3000 / Tape & Reel |
| NCV8537MN250R2G   | 2.5 V          | V8537 250 |                    |                               |                    |
| NCV8537MN330R2G   | 3.3 V          | V8537 330 |                    |                               |                    |
| NCV8537MN500R2G   | 5.0 V          | V8537 500 |                    |                               |                    |
| NCV8537MNADJR2G   | Adj            | V8537 ADJ |                    |                               |                    |
| NCV8537ML180R2G** | 1.8 V          | L8537 180 | DFN10<br>(Pb-Free) | Wettable Flank<br>SLP Process | 3000 / Tape & Reel |
| NCV8537ML250R2G** | 2.5 V          | L8537 250 |                    |                               |                    |
| NCV8537ML330R2G** | 3.3 V          | L8537 330 |                    |                               |                    |
| NCV8537ML500R2G** | 5.0 V          | L8537 500 |                    |                               |                    |
| NCV8537MLADJR2G** | Adj            | L8537 ADJ |                    |                               |                    |

†For information on tape and reel specifications, including part orientation and tape sizes, please refer to our Tape and Reel Packaging Specifications Brochure, BRD8011/D.

\*NCV Prefix for Automotive and Other Applications Requiring Unique Site and Control Change Requirements; AEC-Q100 Qualified and PPAP Capable.

\*\*In Development.

# NCV8537

## PACKAGE DIMENSIONS

DFN10, 3x3, 0.5P  
CASE 485C  
ISSUE E

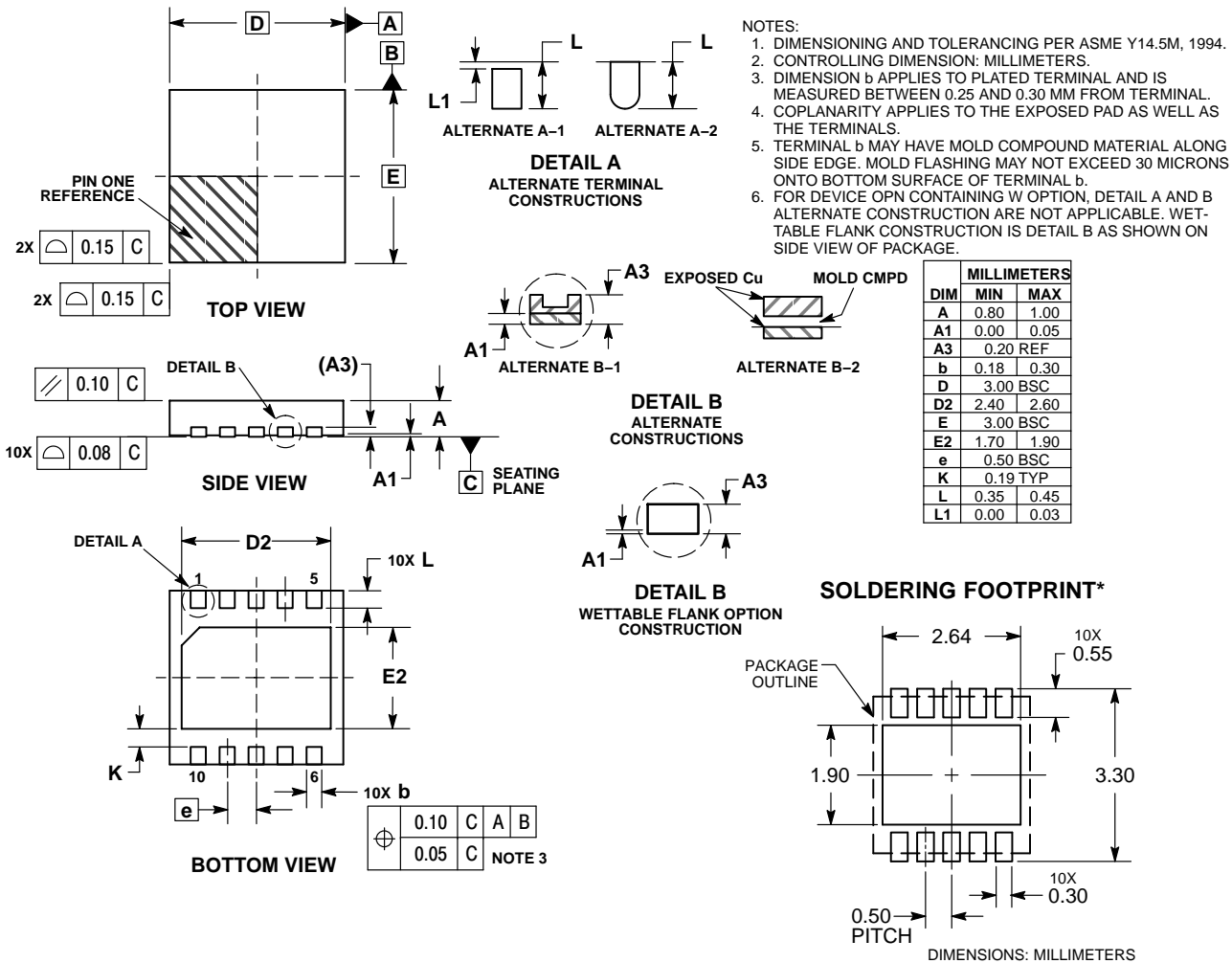

- NOTES:
1. DIMENSIONING AND TOLERANCING PER ASME Y14.5M, 1994.
  2. CONTROLLING DIMENSION: MILLIMETERS.
  3. DIMENSION b APPLIES TO PLATED TERMINAL AND IS MEASURED BETWEEN 0.25 AND 0.30 MM FROM TERMINAL.
  4. COPLANARITY APPLIES TO THE EXPOSED PAD AS WELL AS THE TERMINALS.
  5. TERMINAL b MAY HAVE MOLD COMPOUND MATERIAL ALONG SIDE EDGE. MOLD FLASHING MAY NOT EXCEED 30 MICRONS ONTO BOTTOM SURFACE OF TERMINAL b.
  6. FOR DEVICE OPN CONTAINING W OPTION, DETAIL A AND B ALTERNATE CONSTRUCTION ARE NOT APPLICABLE. WETTABLE FLANK CONSTRUCTION IS DETAIL B AS SHOWN ON SIDE VIEW OF PACKAGE.

\*For additional information on our Pb-Free strategy and soldering details, please download the ON Semiconductor Soldering and Mounting Techniques Reference Manual, SOLDERRM/D.

ON Semiconductor and are trademarks of Semiconductor Components Industries, LLC dba ON Semiconductor or its subsidiaries in the United States and/or other countries. ON Semiconductor owns the rights to a number of patents, trademarks, copyrights, trade secrets, and other intellectual property. A listing of ON Semiconductor's product/patent coverage may be accessed at [www.onsemi.com/site/pdf/Patent-Marking.pdf](http://www.onsemi.com/site/pdf/Patent-Marking.pdf). ON Semiconductor reserves the right to make changes without further notice to any products herein. ON Semiconductor makes no warranty, representation or guarantee regarding the suitability of its products for any particular purpose, nor does ON Semiconductor assume any liability arising out of the application or use of any product or circuit, and specifically disclaims any and all liability, including without limitation special, consequential or incidental damages. Buyer is responsible for its products and applications using ON Semiconductor products, including compliance with all laws, regulations and safety requirements or standards, regardless of any support or applications information provided by ON Semiconductor. "Typical" parameters which may be provided in ON Semiconductor data sheets and/or specifications can and do vary in different applications and actual performance may vary over time. All operating parameters, including "Typicals" must be validated for each customer application by customer's technical experts. ON Semiconductor does not convey any license under its patent rights nor the rights of others. ON Semiconductor products are not designed, intended, or authorized for use as a critical component in life support systems or any FDA Class 3 medical devices or medical devices with a same or similar classification in a foreign jurisdiction or any devices intended for implantation in the human body. Should Buyer purchase or use ON Semiconductor products for any such unintended or unauthorized application, Buyer shall indemnify and hold ON Semiconductor and its officers, employees, subsidiaries, affiliates, and distributors harmless against all claims, costs, damages, and expenses, and reasonable attorney fees arising out of, directly or indirectly, any claim of personal injury or death associated with such unintended or unauthorized use, even if such claim alleges that ON Semiconductor was negligent regarding the design or manufacture of the part. ON Semiconductor is an Equal Opportunity/Affirmative Action Employer. This literature is subject to all applicable copyright laws and is not for resale in any manner.

### PUBLICATION ORDERING INFORMATION

#### LITERATURE FULFILLMENT:

Literature Distribution Center for ON Semiconductor  
19521 E. 32nd Pkwy, Aurora, Colorado 80011 USA  
Phone: 303-675-2175 or 800-344-3860 Toll Free USA/Canada  
Fax: 303-675-2176 or 800-344-3867 Toll Free USA/Canada  
Email: [orderlit@onsemi.com](mailto:orderlit@onsemi.com)

N. American Technical Support: 800-282-9855 Toll Free  
USA/Canada  
Europe, Middle East and Africa Technical Support:  
Phone: 421 33 790 2910  
Japan Customer Focus Center  
Phone: 81-3-5817-1050

ON Semiconductor Website: [www.onsemi.com](http://www.onsemi.com)

Order Literature: <http://www.onsemi.com/orderlit>

For additional information, please contact your local Sales Representative