

# NCP51199, NCV51199

## DDR 2-Amp Source / Sink $V_{TT}$ Termination Regulator

The NCP/NCV51199 is a linear regulator designed to supply a regulated  $V_{TT}$  termination voltage for DDR-2 and DDR-3 memory applications. The regulator is capable of actively sourcing and sinking  $\pm 2$  A peak currents for DDR-2, and DDR-3 up to  $\pm 1.5$  A while regulating the  $V_{TT}$  output voltage to within  $\pm 10$  mV. The output termination voltage is regulated to track  $V_{DDQ} / 2$  by two external voltage divider resistors connected to the  $PV_{CC}$ , GND, and  $V_{REF}$  pins.

The NCP/NCV51199 incorporates a high-speed differential amplifier to provide ultra-fast response to line and load transients. Other features include source/sink current limiting, soft-start and on-chip thermal shutdown protection.

### Features

- Supports DDR-2  $V_{TT}$  Termination to  $\pm 2$  A, DDR-3 to  $\pm 1.5$  A (peak)
- Stable with 10  $\mu$ F Ceramic Capacitance on  $V_{TT}$  Output
- Integrated Power MOSFETs
- High Accuracy  $V_{TT}$  Output at Full-Load
- Fast Transient Response
- Built-in Soft-Start
- Shutdown for Standby or Suspend Mode
- Integrated Thermal and Current-Limit Protection
- NCV Prefix for Automotive and Other Applications Requiring Unique Site and Control Change Requirements; AEC-Q100 Qualified and PPAP Capable
- These Devices are Pb-Free and are RoHS Compliant

### Typical Applications

- SDRAM Termination Voltage for DDR-2 / DDR-3
- Motherboard, Notebook, and VGA Card Memory Termination
- Set Top Box, Digital TV, Printers



ON Semiconductor®

[www.onsemi.com](http://www.onsemi.com)

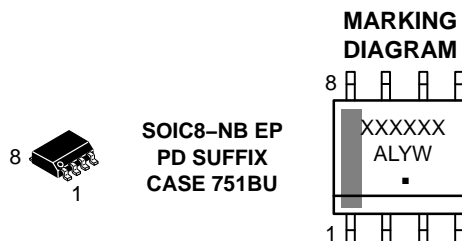

SOIC8-NB EP  
PD SUFFIX  
CASE 751BU

XXXXXX = Specific Device Code  
A = Assembly Location  
L = Wafer Lot  
Y = Year  
WW = Work Week  
▪ = Pb-Free Package

### PIN CONNECTION

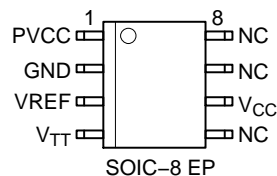

### ORDERING INFORMATION

See detailed ordering, marking and shipping information in the package dimensions section on page 6 of this data sheet.

# NCP51199, NCV51199

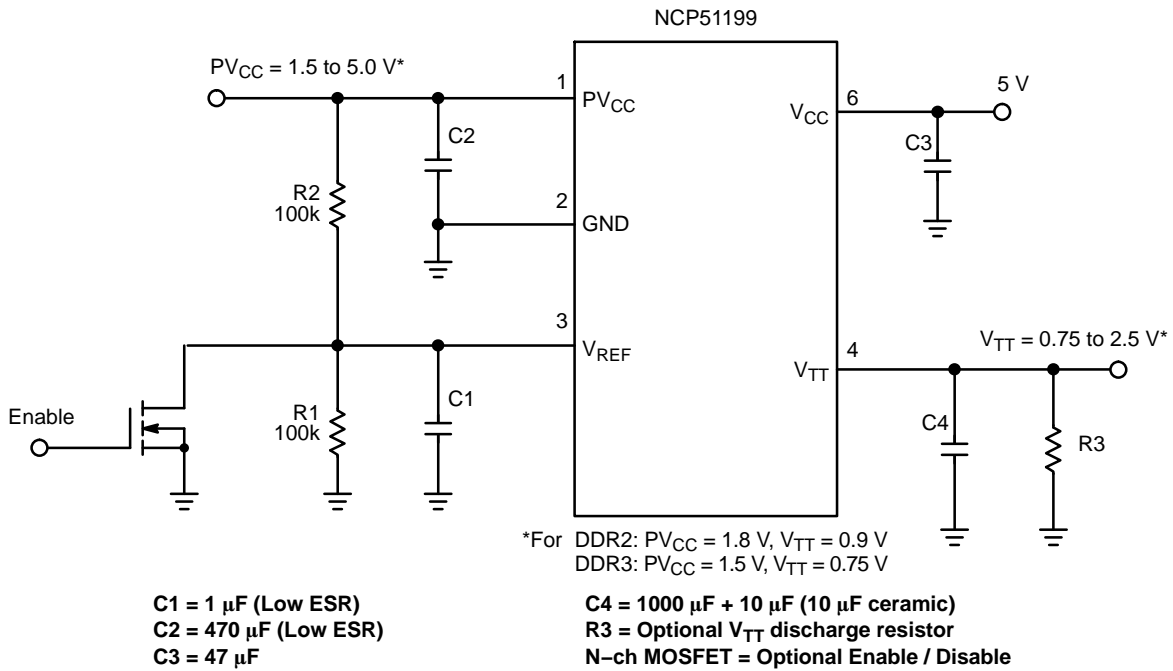

Figure 1. Application Diagram

## PIN FUNCTION DESCRIPTION

Pin No.	Pin Name	Description
1	$PV_{CC}$	Input voltage which supplies current to the output pin. $C_{IN} = 470 \mu\text{F}$ with low ESR.
2	$GND$	Common Ground
3	$V_{REF}$	Buffered reference voltage input equal to $\frac{1}{2}$ of $V_{DDQ}$ and active low shutdown pin. An external resistor divider dividing down the $PV_{CC}$ voltage creates the regulated output voltage. Pulling the pin to ground (0.15 V maximum) turns the device off.
4	$V_{TT}$	Regulator output voltage capable of sourcing and sinking current while regulating the output rail. $C_{OUT} = 1000 \mu\text{F} + 10 \mu\text{F}$ ceramic with low ESR.
5	NC	True No Connect
6	$V_{CC}$	The $V_{CC}$ pin is a 5 V input pin that provides internal bias to the controller. $PV_{CC}$ should always be kept lower or equal to $V_{CC}$ .
7	NC	True No Connect
8	NC	True No Connect
EP	Thermal Pad	Pad for thermal connection. The exposed pad must be connected to the ground plane using multiple vias for maximum power dissipation performance.

# NCP51199, NCV51199

## ABSOLUTE MAXIMUM RATINGS

Rating	Symbol	Value	Unit
Input Supply Voltage Range ( $V_{CC} \geq PV_{CC}$ ) (Note 1)	$PV_{CC}, V_{CC}$	-0.3 to 6	V
Output Voltage Range	$V_{TT}$	-0.3 to 6	V
Reference Input Range	$V_{REF}$	-0.3 to 6	V
Maximum Junction Temperature	$T_{J(max)}$	125	°C
Storage Temperature Range	TSTG	-65 to 150	°C
ESD Capability, Human Body Model (Note 2)	ESDHBM	2	kV
ESD Capability, Machine Model (Note 2)	ESDMM	150	V
Lead Temperature Soldering Reflow (SMD Styles Only), Pb-Free Versions (Note 3)	$T_{SLD}$	260	°C

Stresses exceeding those listed in the Maximum Ratings table may damage the device. If any of these limits are exceeded, device functionality should not be assumed, damage may occur and reliability may be affected.

1. Refer to ELECTRICAL CHARACTERISTICS and APPLICATION INFORMATION for Safe Operating Area.
2. This device series incorporates ESD protection and is tested by the following methods:  
ESD Human Body Model tested per AEC-Q100-002 (EIA/JESD22-A114)  
ESD Machine Model tested per AEC-Q100-003 (EIA/JESD22-A115)  
Latchup Current Maximum Rating:  $\leq 150$  mA per JEDEC standard: JESD78
3. For information, please refer to our Soldering and Mounting Techniques Reference Manual, SOLDERRM/D

## THERMAL CHARACTERISTICS

Rating	Symbol	Value	Unit
Thermal Characteristics, SO8-EP (Note 4) Thermal Resistance, Junction-to-Air (Note 5) Power Rating at 25°C Ambient = 1.19 W, derate 12 mW/°C Thermal Reference, Junction-to-Lead2 (Note 5)	$R_{\theta JA}$ $R_{\psi JL}$	84 20	°C/W

4. Refer to ELECTRICAL CHARACTERISTICS and APPLICATION INFORMATION for Safe Operating Area.
5. Values based on copper area of 645 mm<sup>2</sup> (or 1 in<sup>2</sup>) of 1 oz copper thickness and FR4 PCB substrate.

## OPERATING RANGES (Note 6)

Rating	Symbol	Min	Max	Unit
Input Voltage	$PV_{CC}$	1.5	5.5	V
Bias Supply Voltage	$V_{CC}$	4.75	5.25	V
Ambient Temperature	$T_A$	-40	85	°C
Junction Temperature	$T_J$	-40	125	°C

6. Refer to ELECTRICAL CHARACTERISTICS and APPLICATION INFORMATION for Safe Operating Area.

# NCP51199, NCV51199

## ELECTRICAL CHARACTERISTICS

$PV_{CC} = 1.8\text{ V} / 1.5\text{ V}$ ;  $V_{CC} = 5\text{ V}$ ;  $V_{REF} = 0.9\text{ V} / 0.75\text{ V}$ ;  $C_{OUT} = 10\text{ }\mu\text{F}$  (Ceramic);  $T_A = +25^\circ\text{C}$ , unless otherwise noted.

Parameter	Test Conditions	Symbol	Min	Typ	Max	Unit
-----------	-----------------	--------	-----	-----	-----	------

### REGULATOR OUTPUT

Output Offset Voltage	$I_{out} = 0\text{ A}$	$V_{OS}$	-20	-	+20	mV
Load Regulation	$V_{REF} = 900\text{ mV}$ , $I_{out} = \pm 1.8\text{ A}$ , $PV_{CC} = 1.8\text{ V}$ $V_{REF} = 750\text{ mV}$ , $I_{out} = \pm 1.4\text{ A}$ , $PV_{CC} = 1.5\text{ V}$	$Reg_{load}$	-10	-	+10	mV

### INPUT AND STANDBY CURRENTS

Bias Supply Current	$I_{out} = 0\text{ A}$	$I_{BIAS}$	-	0.8	2.5	mA
Standby Current	$V_{REF} < 0.2\text{ V}$ (Shutdown), $R_{LOAD} = 180\Omega$	$I_{STB}$	-	1	90	$\mu\text{A}$

### CURRENT LIMIT PROTECTION

Current Limit	$PV_{CC} = 1.8\text{ V}$ , $V_{REF} = 0.9\text{ V}$	$I_{LIM}$	2.0	-	3.5	A
	$PV_{CC} = 1.5\text{ V}$ , $V_{REF} = 0.75\text{ V}$		1.5	-	3.5	

### SHUTDOWN THRESHOLDS

Shutdown Threshold Voltage	Enable	$V_{IH}$	0.6	-	-	V
	Shutdown	$V_{IL}$	-	-	0.15	

### THERMAL SHUTDOWN

Thermal Shutdown Temperature	$V_{CC} = 5\text{ V}$	$T_{SD}$	160	168	176	$^\circ\text{C}$
Thermal Shutdown Hysteresis	$V_{CC} = 5\text{ V}$	$T_{SH}$	35	35	40	$^\circ\text{C}$

TYPICAL CHARACTERISTICS

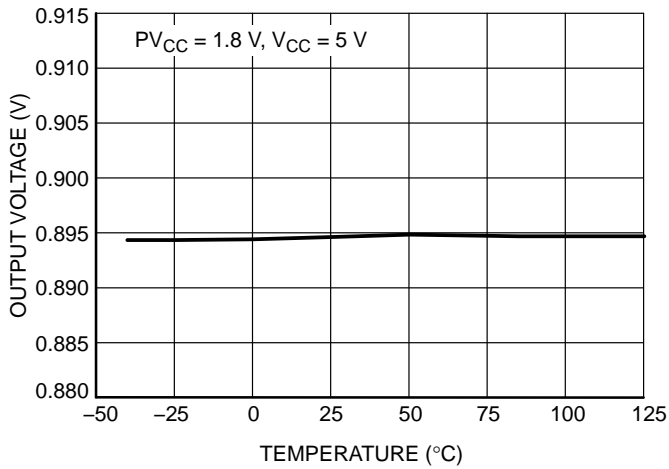

Figure 2. Output Voltage vs. Temperature

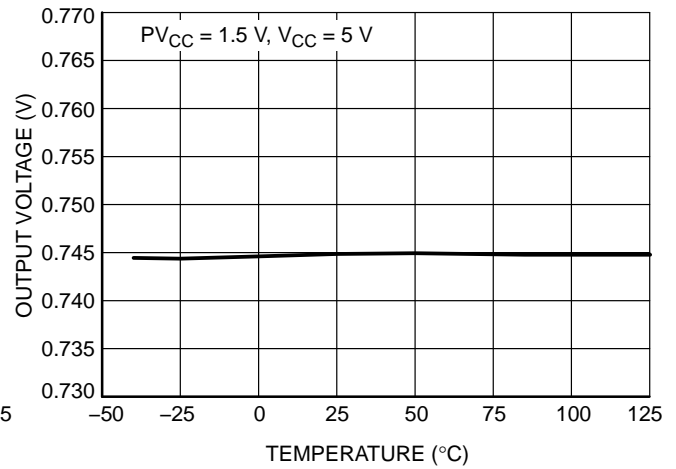

Figure 3. Output Voltage vs. Temperature

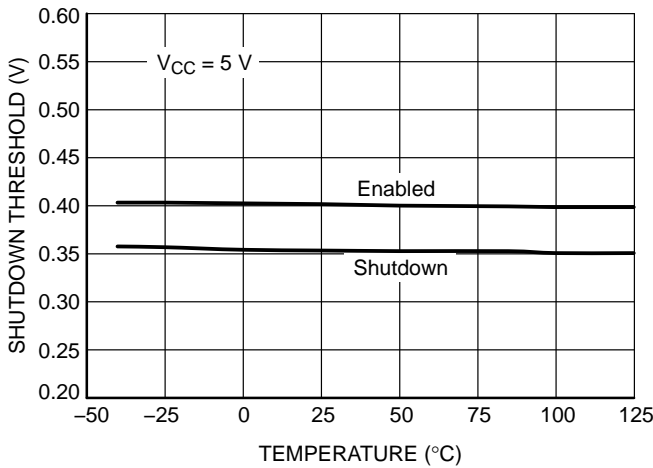

Figure 4. Shutdown Threshold vs. Temperature

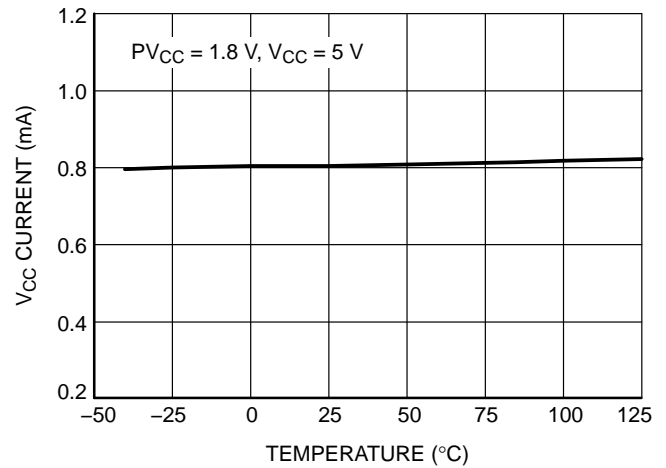

Figure 5. VCC Current vs. Temperature

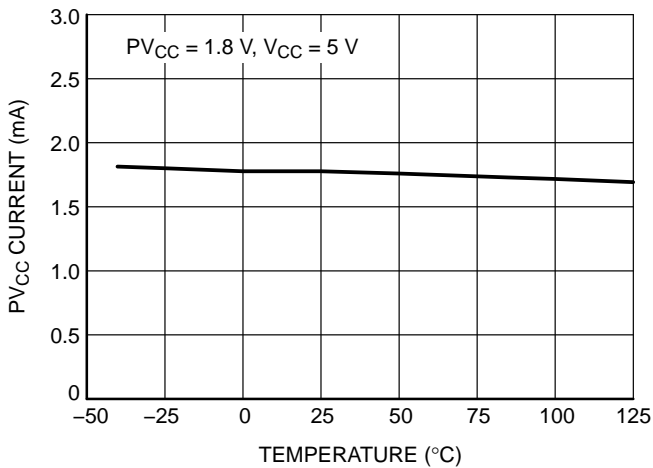

Figure 6. PVCC Current vs. Temperature

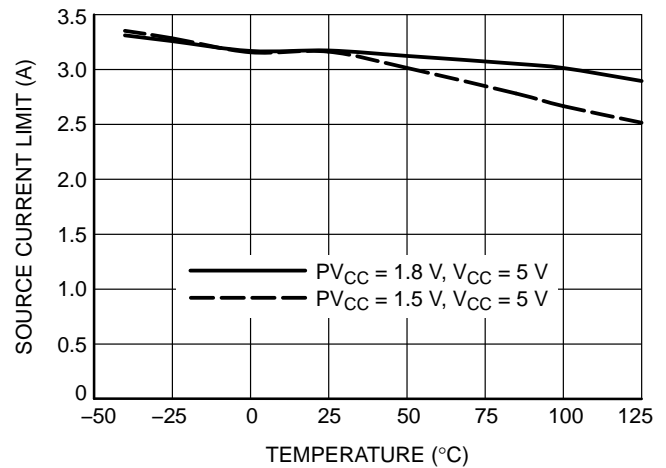

Figure 7. Source Current Limits vs. Temperature

# NCP51199, NCV51199

## TYPICAL CHARACTERISTICS

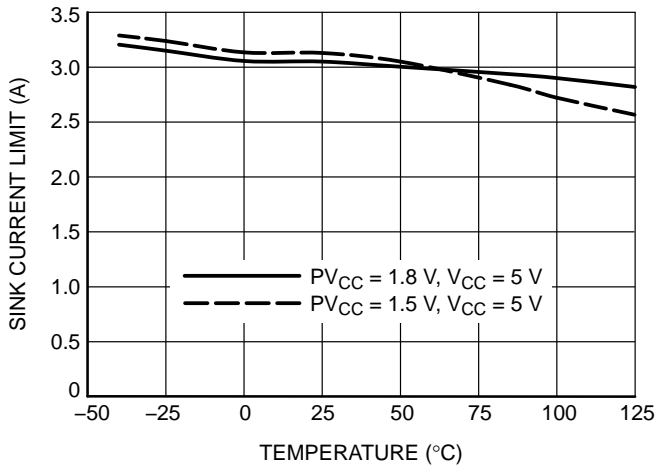

Figure 8. Sink Current Limits vs. Temperature

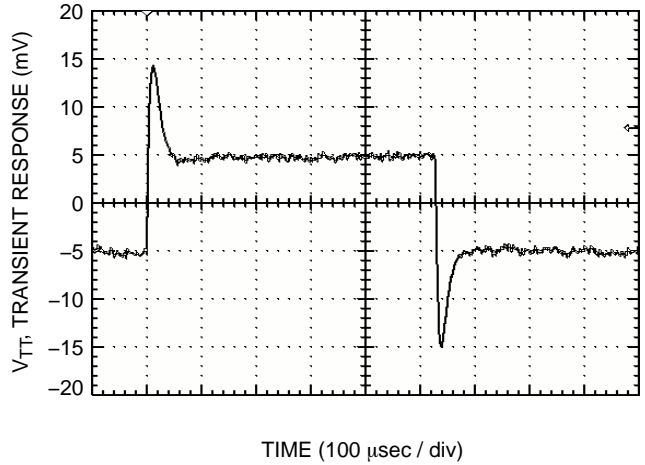

Figure 9. 1.25 V, ±1.6 A Transient Response

Table 1. ORDERING INFORMATION

Device	Marking	Package	Shipping †
NCP51199PDR2G	51199	SOIC-8 (Pb-Free)	2500 / Tape & Reel
NCV51199PDR2G*	V51199		

†For information on tape and reel specifications, including part orientation and tape sizes, please refer to our Tape and Reel Packaging Specifications Brochure, BRD8011/D.

\*NCV Prefix for Automotive and Other Applications Requiring Unique Site and Control Change Requirements; AEC-Q100 Qualified and PPAP Capable.

# NCP51199, NCV51199

## PACKAGE DIMENSIONS

### SOIC8-NB EP CASE 751BU ISSUE E

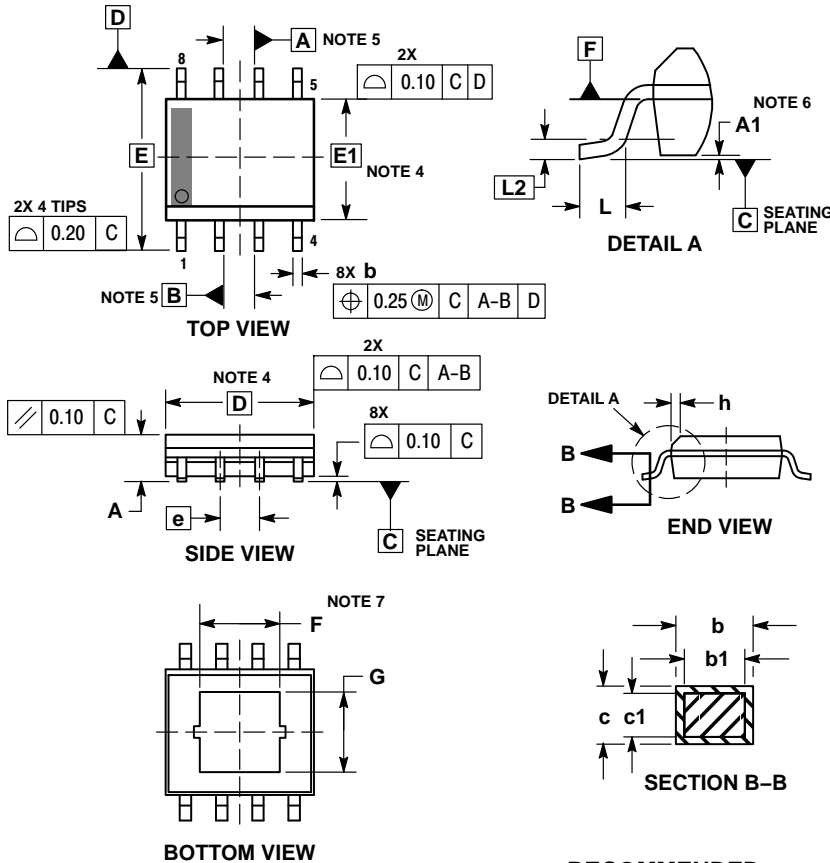

- NOTES:
1. DIMENSIONING AND TOLERANCING PER ASME Y14.5M, 1994.
  2. CONTROLLING DIMENSION: MILLIMETERS.
  3. DIMENSION b DOES NOT INCLUDE DAMBAR PROTRUSION, ALLOWABLE PROTRUSION SHALL BE 0.10mm IN EXCESS OF MAXIMUM MATERIAL CONDITION.
  4. DIMENSION D DOES NOT INCLUDE MOLD FLASH, PROTRUSIONS, OR GATE BURRS. MOLD FLASH, PROTRUSIONS, OR GATE BURRS SHALL NOT EXCEED 0.15mm PER SIDE. DIMENSION E DOES NOT INCLUDE INTERLEAD FLASH OR PROTRUSION. INTERLEAD FLASH OR PROTRUSION SHALL NOT EXCEED 0.25mm PER SIDE. DIMENSIONS D AND E ARE DETERMINED AT DATUM F.
  5. DIMENSIONS A AND B ARE TO BE DETERMINED AT DATUM F.
  6. A1 IS DEFINED AS THE VERTICAL DISTANCE FROM THE SEATING PLANE TO THE LOWEST POINT ON THE PACKAGE BODY.
  7. TAB CONTOUR MAY VARY MINIMALLY TO INCLUDE TOOLING FEATURES.

DIM	MILLIMETERS	
	MIN	MAX
A	1.35	1.75
A1	0.00	0.10
b	0.31	0.51
b1	0.28	0.48
c	0.17	0.25
c1	0.17	0.23
D	4.90 BSC	
E	6.00 BSC	
E1	3.90 BSC	
e	1.27 BSC	
F	1.55	2.39
G	1.55	2.39
h	0.25	0.50
L	0.40	1.27
L2	0.25 BSC	

### RECOMMENDED SOLDERING FOOTPRINT\*

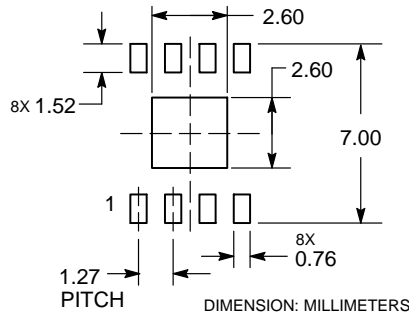

\*For additional information on our Pb-Free strategy and soldering details, please download the ON Semiconductor Soldering and Mounting Techniques Reference Manual, SOLDERRM/D.

ON Semiconductor and  are trademarks of Semiconductor Components Industries, LLC dba ON Semiconductor or its subsidiaries in the United States and/or other countries. ON Semiconductor owns the rights to a number of patents, trademarks, copyrights, trade secrets, and other intellectual property. A listing of ON Semiconductor's product/patent coverage may be accessed at [www.onsemi.com/site/pdf/Patent-Marking.pdf](http://www.onsemi.com/site/pdf/Patent-Marking.pdf). ON Semiconductor reserves the right to make changes without further notice to any products herein. ON Semiconductor makes no warranty, representation or guarantee regarding the suitability of its products for any particular purpose, nor does ON Semiconductor assume any liability arising out of the application or use of any product or circuit, and specifically disclaims any and all liability, including without limitation special, consequential or incidental damages. Buyer is responsible for its products and applications using ON Semiconductor products, including compliance with all laws, regulations and safety requirements or standards, regardless of any support or applications information provided by ON Semiconductor. "Typical" parameters which may be provided in ON Semiconductor data sheets and/or specifications can and do vary in different applications and actual performance may vary over time. All operating parameters, including "Typicals" must be validated for each customer application by customer's technical experts. ON Semiconductor does not convey any license under its patent rights nor the rights of others. ON Semiconductor products are not designed, intended, or authorized for use as a critical component in life support systems or any FDA Class 3 medical devices or medical devices with a same or similar classification in a foreign jurisdiction or any devices intended for implantation in the human body. Should Buyer purchase or use ON Semiconductor products for any such unintended or unauthorized application, Buyer shall indemnify and hold ON Semiconductor and its officers, employees, subsidiaries, affiliates, and distributors harmless against all claims, costs, damages, and expenses, and reasonable attorney fees arising out of, directly or indirectly, any claim of personal injury or death associated with such unintended or unauthorized use, even if such claim alleges that ON Semiconductor was negligent regarding the design or manufacture of the part. ON Semiconductor is an Equal Opportunity/Affirmative Action Employer. This literature is subject to all applicable copyright laws and is not for resale in any manner.

## PUBLICATION ORDERING INFORMATION

### LITERATURE FULFILLMENT:

Literature Distribution Center for ON Semiconductor  
19521 E. 32nd Pkwy, Aurora, Colorado 80011 USA  
**Phone:** 303-675-2175 or 800-344-3860 Toll Free USA/Canada  
**Fax:** 303-675-2176 or 800-344-3867 Toll Free USA/Canada  
**Email:** [orderlit@onsemi.com](mailto:orderlit@onsemi.com)

**N. American Technical Support:** 800-282-9855 Toll Free  
USA/Canada  
**Europe, Middle East and Africa Technical Support:**  
Phone: 421 33 790 2910  
**Japan Customer Focus Center**  
Phone: 81-3-5817-1050

**ON Semiconductor Website:** [www.onsemi.com](http://www.onsemi.com)  
**Order Literature:** <http://www.onsemi.com/orderlit>  
For additional information, please contact your local  
Sales Representative