

# NCP4632

## 3A, Low Voltage, Low Dropout Linear Voltage Regulator with Reverse Current Protection

The NCP4632 is a CMOS Linear voltage regulator with high output current capability (up to 3 A). This device can provide output voltages as low as 0.8 V while maintaining a low dropout voltage of 510 mV typ. at full load. The NCP4632 is designed to draw only 350  $\mu$ A of supply current and less than 1  $\mu$ A in standby mode to minimize current consumption for battery operated applications. The device has a high accuracy output voltage of  $\pm 1\%$  along with soft-start and reverse current protection circuits to protect the device and the application. The NCP4632 is available in a Pb-Free DPAK-5 package in both fixed and adjustable output voltage options. The output voltage for the fixed options can be modified in 0.1 V steps from 0.8 V to 4.2 V. Please contact your sales office for any additional fixed voltage outputs to those already listed.

### Features

- Operating Input Voltage Range: 1.6 V to 5.25 V
- Output Voltage Range: 0.8 to 4.5 V (0.1 V steps for fixed options)
- Supply current: Typical Operation Mode – 350.0  $\mu$ A  
Standby Mode – 1.0  $\mu$ A
- Dropout Voltage:  
150 mV Typ. at  $I_{OUT} = 1$  A,  $V_{OUT} = 2.5$  V  
510 mV Typ. at  $I_{OUT} = 3$  A,  $V_{OUT} = 2.5$  V
- $\pm 1\%$  Output Voltage Accuracy
- Line Regulation 0.15%/V Typ.
- Current Fold Back Protection Typ. 220 mA
- Stable with Ceramic Capacitors
- Available in DPAK-5 Package (TO252-5)
- These are Pb-Free Devices

### Typical Applications

- Battery Powered Equipments
- Portable Communication Equipments
- Cameras, VCRs and Camcorders
- Home appliances

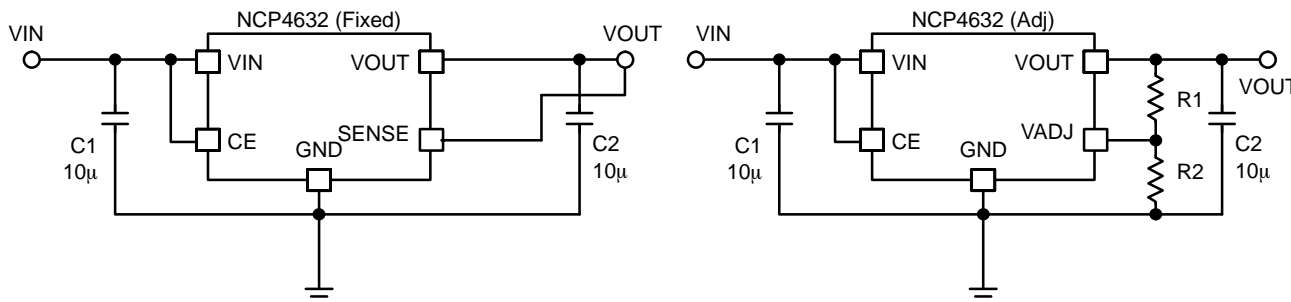

Figure 1. Typical Application Schematics



ON Semiconductor®

[www.onsemi.com](http://www.onsemi.com)

### MARKING DIAGRAM

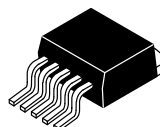

DPAK-5  
CASE 369AE

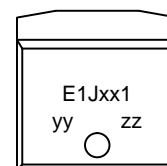

1 2 3 4 5

xx = Specific Device Code  
YY = B – Without Active Discharge  
= D – With Active Discharge  
zz = Lot Number

### ORDERING INFORMATION

See detailed ordering and shipping information in the package dimensions section on page 13 of this data sheet.

# NCP4632

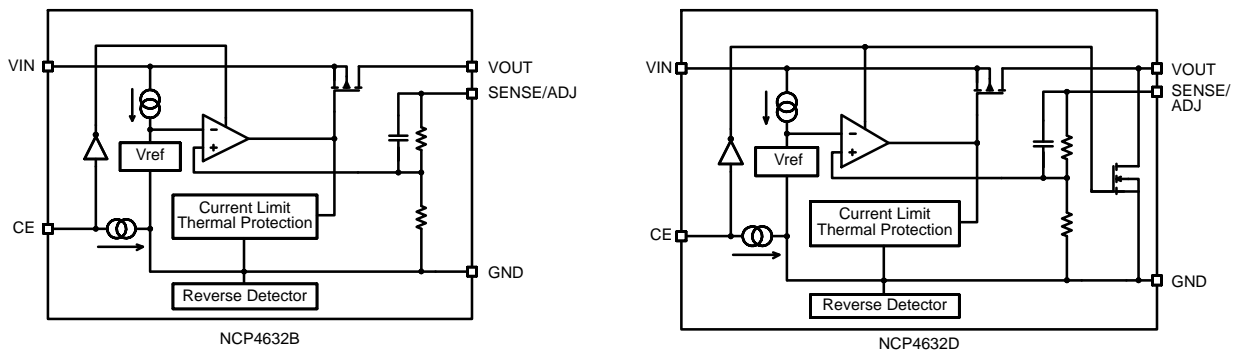

Figure 2. Simplified Schematic Block Diagram

## PIN FUNCTION DESCRIPTION

Pin No. TO252-5-P2	Pin Name	Description
4	VOUT	Output Voltage Pin
2	VIN	Input Voltage Pin
3	GND (Note 1)	Ground Pin
1	CE	Chip Enable Pin, Active "H", Connect to VIN pin if not used.
5	SENSE / ADJ	Sense Pin on Fixed Options, ADJ for Adjustable

1. TAB is internally connected to pin 3 GND.

## ABSOLUTE MAXIMUM RATINGS

Rating	Symbol	Value	Unit
Input Voltage	$V_{IN}$	6.0	V
Output Voltage	$V_{OUT}$	-0.3 to $V_{IN} + 0.3$	V
Chip Enable Input	$V_{CE}$	-0.3 to 6.0	V
Sense Input	$V_{sense}$	-0.3 to 6.0	V
Output Current	$I_{OUT}$	3000	mA
Power Dissipation (Note 2)	$P_{D(MAX)}$	3800	mW
Storage Temperature Range	$T_{STG}$	-55 to 125	°C
Maximum Junction Temperature	$T_{J(MAX)}$	125	°C
ESD Capability, Human Body Model (Note 3)	$ESD_{HBM}$	2000	V
ESD Capability, Machine Model (Note 3)	$ESD_{MM}$	200	V

Stresses exceeding those listed in the Maximum Ratings table may damage the device. If any of these limits are exceeded, device functionality should not be assumed, damage may occur and reliability may be affected.

2. JEDEC standard 76.2mm x 114.3 mm, FR4 Four-layers board

3. This device series incorporates ESD protection and is tested by the following methods:

ESD Human Body Model tested per AEC-Q100-002 (EIA/JESD22-A114)

ESD Machine Model tested per AEC-Q100-003 (EIA/JESD22-A115)

Latchup Current Maximum Rating tested per JEDEC standard: JESD78.

## THERMAL CHARACTERISTICS

Rating	Symbol	Value	Unit
Thermal Characteristics, DPAK-5 Thermal Resistance, Junction-to-Air	$R_{\theta JA}$	53	°C/W

# NCP4632

**ELECTRICAL CHARACTERISTICS**  $-40^{\circ}\text{C} \leq T_J \leq 85^{\circ}\text{C}$ ;  $V_{IN} = V_{OUT(NOM)} + 1\text{ V}$ ;  $I_{OUT} = 1\text{ mA}$ ;  $C_{IN} = C_{OUT} = 10\text{ }\mu\text{F}$ ; unless otherwise noted. Typical values are at  $T_J = +25^{\circ}\text{C}$ .

Parameter	Test Conditions		Symbol	Min	Typ	Max	Unit
Operating Input Voltage (Note 4)			$V_{IN}$	1.6		5.25	V
Output Voltage	$T_J = +25^{\circ}\text{C}$ , $I_{OUT} = 5\text{ mA}$	$V_{OUT} > 1.5\text{ V}$	$V_{OUT}$	x0.99		x1.01	V
		$V_{OUT} \leq 1.5\text{ V}$		-15		15	mV
	$-40^{\circ}\text{C} \leq T_J \leq 85^{\circ}\text{C}$ , $I_{OUT} = 5\text{ mA}$	$V_{OUT} > 2\text{ V}$		x0.97		x1.02	V
		$V_{OUT} \leq 2\text{ V}$		-45		30	mV
Output Voltage (Adjustable Option)	$T_J = +25^{\circ}\text{C}$ , $I_{OUT} = 5\text{ mA}$ $V_{OUT} = \text{ADJ}$		$V_{ADJ}$	0.792	0.8	0.808	V
Output Current	$T_J = -40\text{ to }85^{\circ}\text{C}$		$I_{OUT}$	3			A
Line Regulation	$V_{IN} = V_{OUT} + 0.5\text{ V to }5\text{ V}$ , $I_{OUT} = 1\text{ mA}$ $V_{IN} \geq 1.6\text{ V}$ for NCP4632xDT08T5G, $I_{OUT} = 1\text{ mA}$		LineReg	0.15			%/V
Load Regulation			LoadReg	-15	2	20	mV
				-70	3	50	
Dropout Voltage	$T_J = +25^{\circ}\text{C}$ , $I_{OUT} = 1000\text{ mA}$ $V_{OUT} = 3.3\text{ V}$		$V_{DO}$		100		mV
Dropout Voltage	$I_{OUT} = 3000\text{ mA}$	$0.8\text{ V} \leq V_{OUT} < 0.9\text{ V}$	$V_{DO}$		0.910	1.110	V
		$0.9\text{ V} \leq V_{OUT} < 1.0\text{ V}$			0.865	1.000	
		$1.0\text{ V} \leq V_{OUT} < 1.1\text{ V}$			0.810	0.950	
		$1.1\text{ V} \leq V_{OUT} < 1.2\text{ V}$			0.755	0.895	
		$1.2\text{ V} \leq V_{OUT} < 1.5\text{ V}$			0.720	0.840	
		$1.5\text{ V} \leq V_{OUT} < 2.5\text{ V}$			0.630	0.760	
		$2.5\text{ V} \leq V_{OUT} < 3.3\text{ V}$			0.510	0.600	
		$3.3\text{ V} \leq V_{OUT} < 4.2\text{ V}$			0.480	0.560	
Short Current Limit	$V_{OUT} = 0\text{ V}$		$I_{SC}$		220		mA
Quiescent Current	$I_{OUT} = 0\text{ mA}$ , $V_{IN} = 5.25\text{ V}$	$V_{OUT} \leq 1.5\text{ V}$	$I_Q$		390	450	$\mu\text{A}$
		$V_{OUT} > 1.5\text{ V}$			350	430	
Supply Current	$I_{OUT} = 3000\text{ mA}$		$I_{GND}$			450	$\mu\text{A}$
Standby Current	$V_{CE} = 0\text{ V}$ , $T_J = 25^{\circ}\text{C}$		$I_{STB}$		1		$\mu\text{A}$
CE Pin Threshold Voltage	CE Input Voltage "H"		$V_{CEH}$	1.0			V
	CE Input Voltage "L"		$V_{CEL}$			0.4	
CE Pull Down Current			$I_{CEPD}$		0.3	0.6	$\mu\text{A}$
Power Supply Rejection Ratio	$V_{IN} = V_{OUT} + 1\text{ V}$ or $2.2\text{ V}$ whichever is higher, $\Delta V_{IN} = 0.2\text{ V}_{pk-pk}$ , $I_{OUT} = 300\text{ mA}$ , $f = 1\text{ kHz}$		PSRR		55		dB
Output Noise Voltage	$V_{OUT} = 1.5\text{ V}$ , $I_{OUT} = 300\text{ mA}$ , $f = 10\text{ Hz to }100\text{ kHz}$		$V_N$		60		$\mu\text{V}_{rms}$
Auto Discharge Low Output Nch Tr. On Resistance	$V_{IN} = 4\text{ V}$ , $V_{CE} = 0\text{ V}$		$R_{LOW}$		30		$\Omega$
Reverse Current Limit	$V_{OUT} > 0.5\text{ V}$ , $0\text{ V} \leq V_{IN} < 5.25\text{ V}$		$I_{REV}$		10		$\mu\text{A}$

Product parametric performance is indicated in the Electrical Characteristics for the listed test conditions, unless otherwise noted. Product performance may not be indicated by the Electrical Characteristics if operated under different conditions.

4. The maximum Input Voltage of the ELECTRICAL CHARACTERISTICS is 5.25 V. In case of exceeding this specification, the IC must be operated on condition that the Input Voltage is up to 5.5 V and the total operating time is within 500 hrs.

# NCP4632

## TYPICAL CHARACTERISTICS

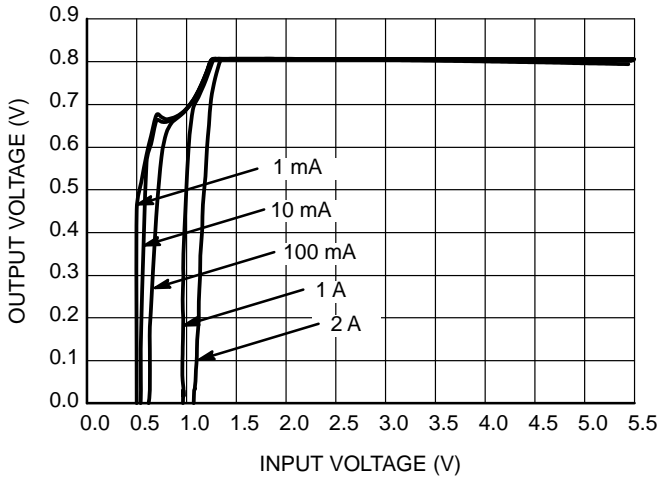

Figure 3. Output Voltage vs. Input Voltage at NCP4632xDT08

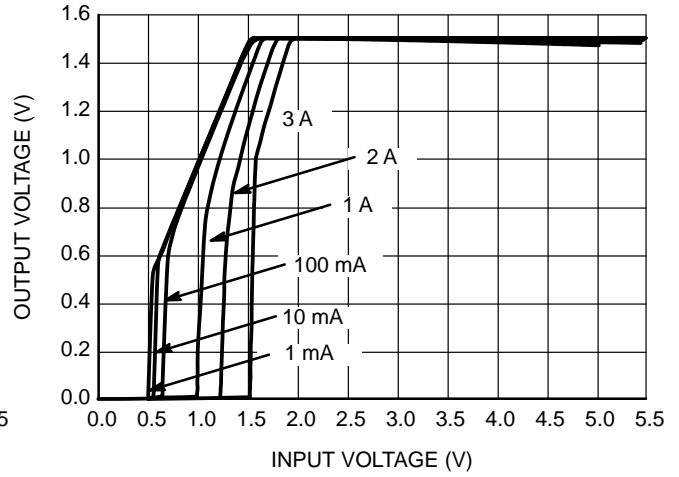

Figure 4. Output Voltage vs. Input Voltage at NCP4632xDT15

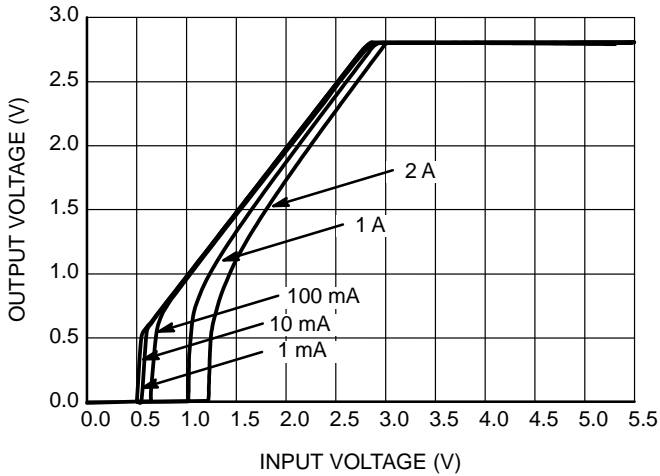

Figure 5. Output Voltage vs. Input Voltage at NCP4632xDT28

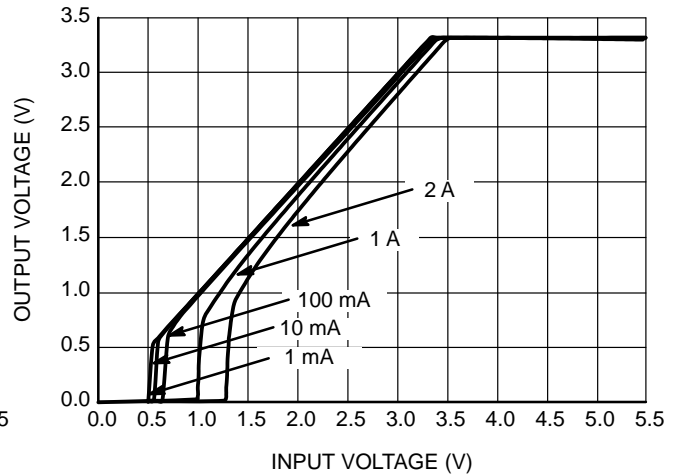

Figure 6. Output Voltage vs. Input Voltage at NCP4632xDT33

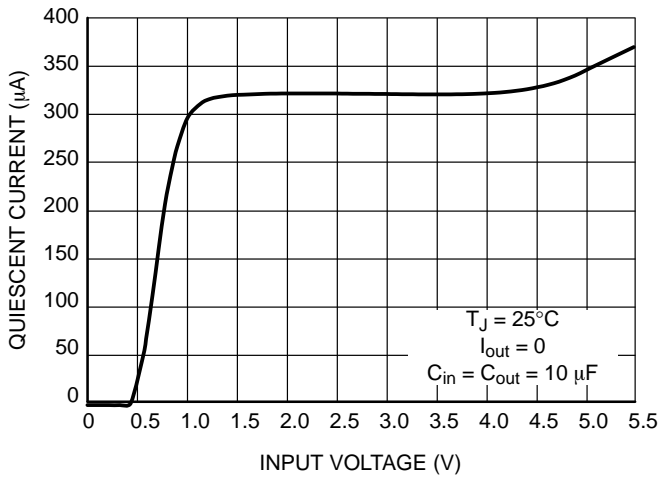

Figure 7. Quiescent Current vs. Input Voltage at NCP4632xDT08

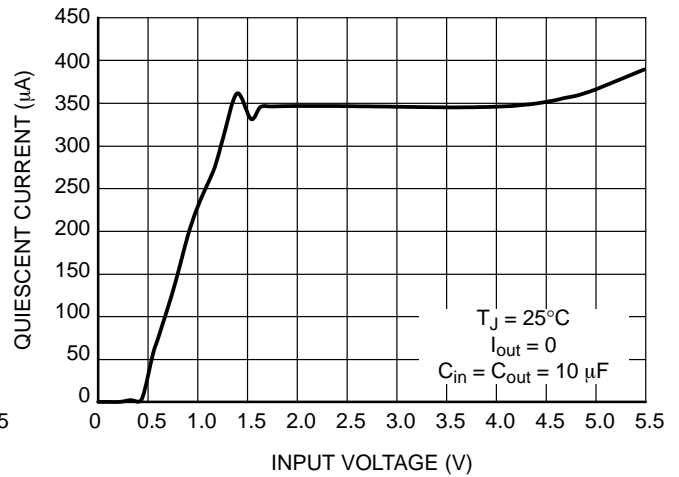

Figure 8. Quiescent Current vs. Input Voltage at NCP4632xDT15

TYPICAL CHARACTERISTICS

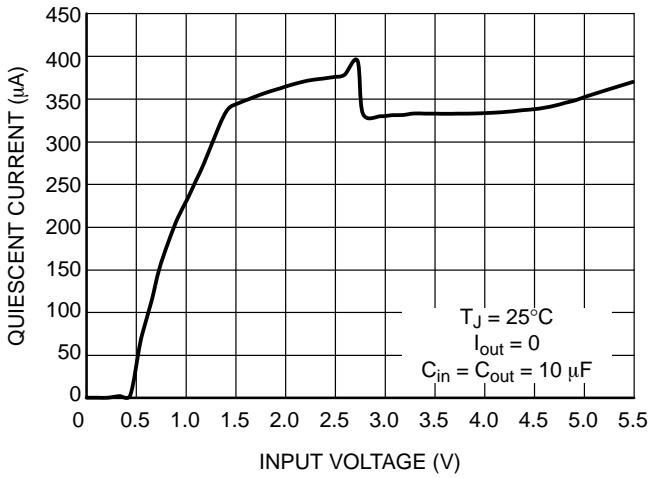

Figure 9. Quiescent Current vs. Input Voltage at NCP4632xDT28

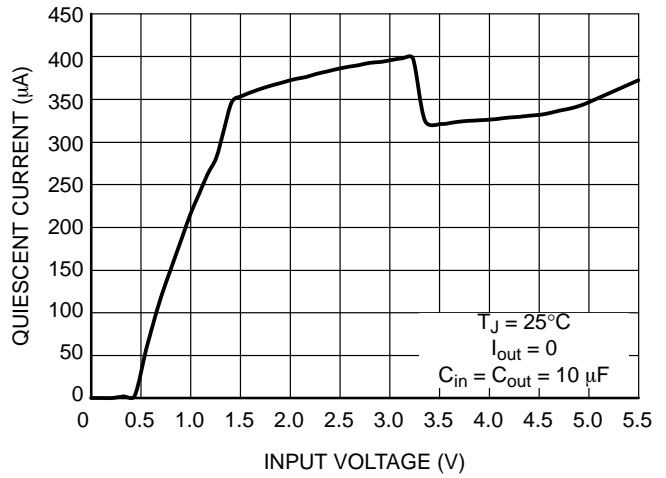

Figure 10. Quiescent Current vs. Input Voltage at NCP4632xDT33

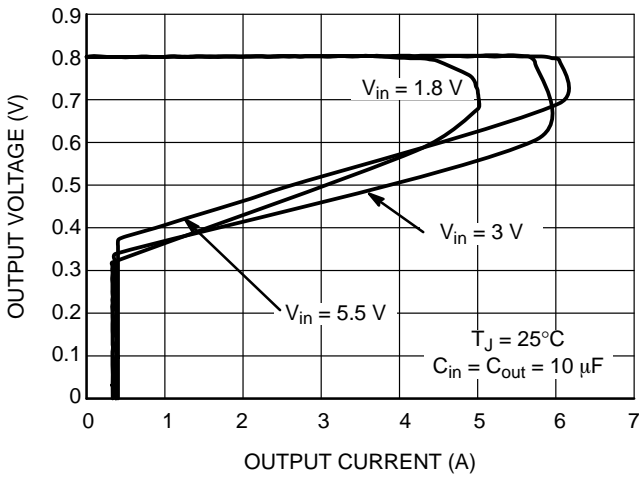

Figure 11. Output Voltage vs. Output Current at NCP4632xDT08

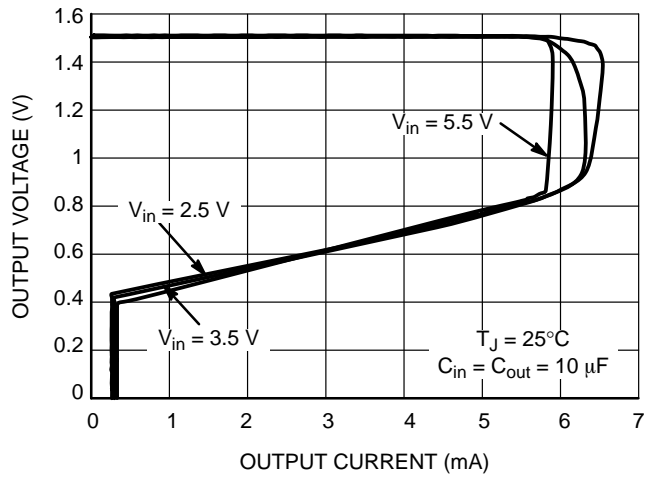

Figure 12. Output Voltage vs. Output Current at NCP4632xDT15

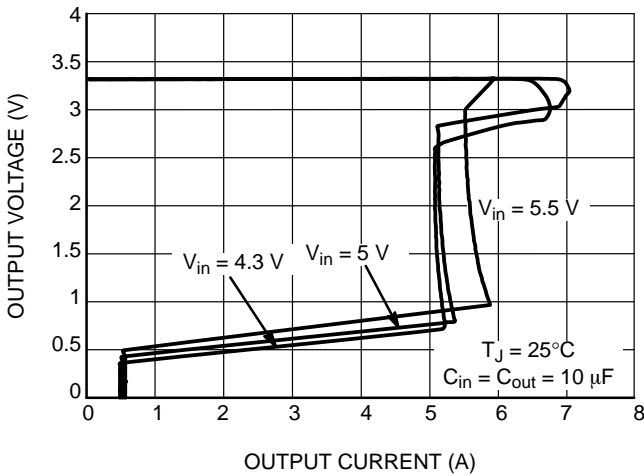

Figure 13. Output Voltage vs. Output Current at NCP4632xDT33

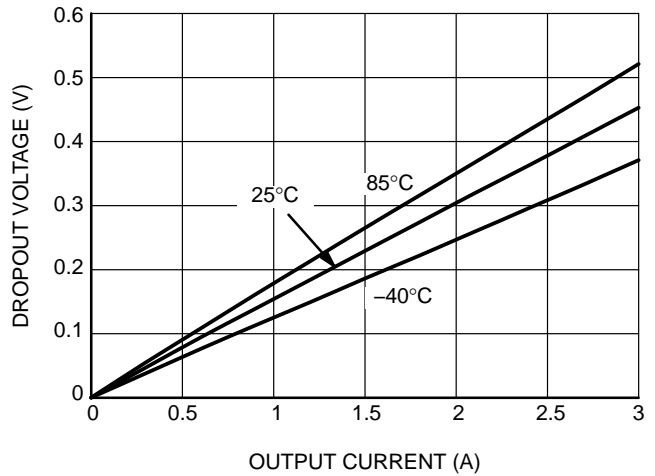

Figure 14. Dropout Voltage vs. Output Current at NCP4632xDT15

# NCP4632

## TYPICAL CHARACTERISTICS

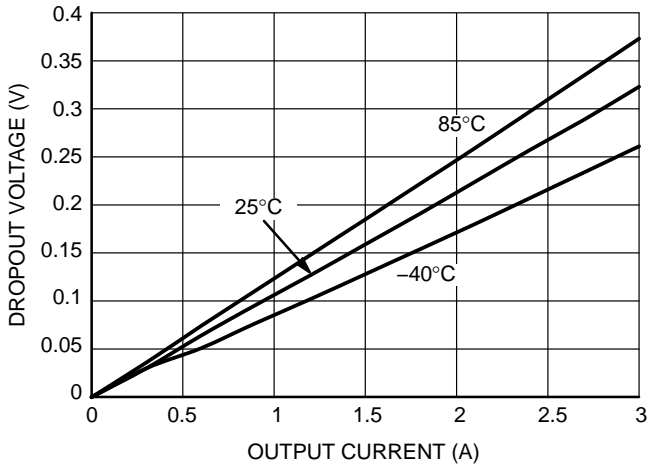

Figure 15. Dropout Voltage vs. Output Current at NCP4632xDT28

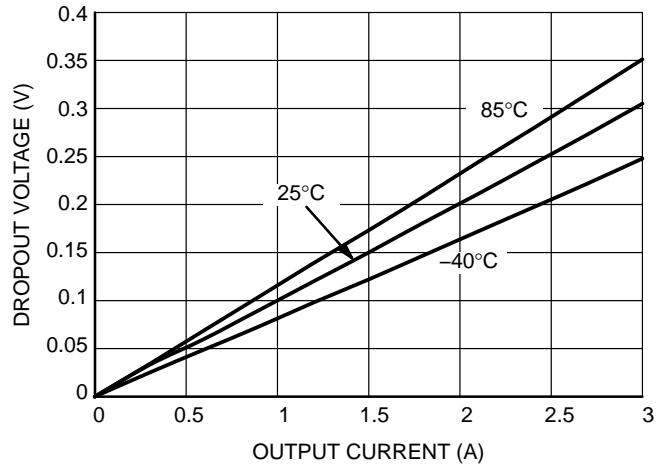

Figure 16. Dropout Voltage vs. Output Current at NCP4632xDT33

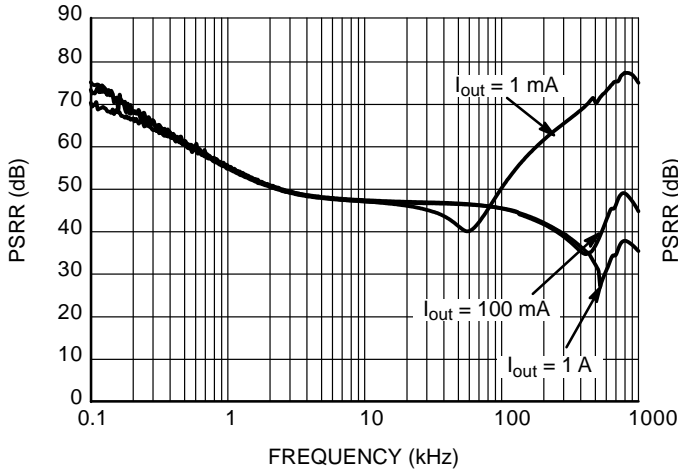

Figure 17. PSRR vs. Frequency at NCP4632xDT08

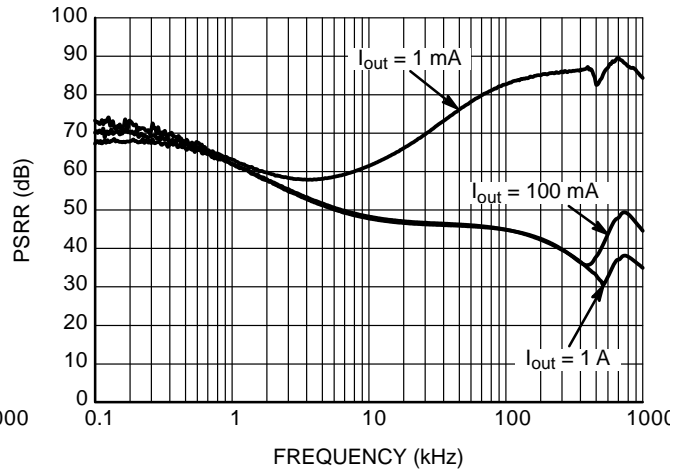

Figure 18. PSRR vs. Frequency at NCP4632xDT15

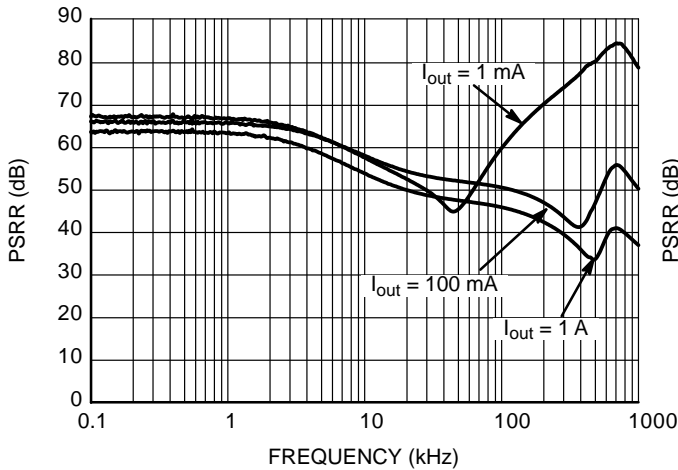

Figure 19. PSRR vs. Frequency at NCP4632xDT28

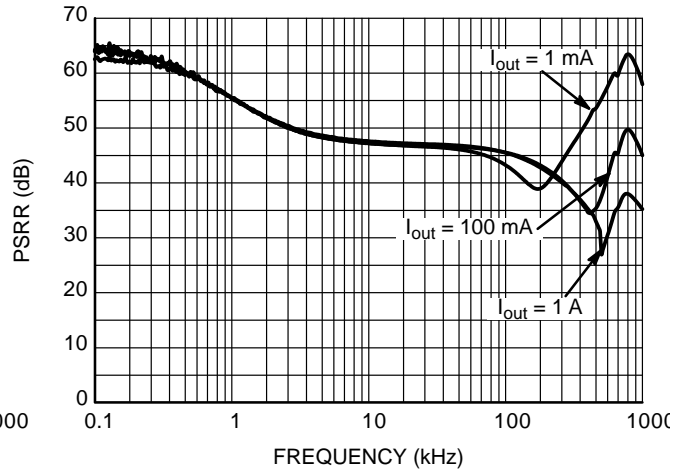
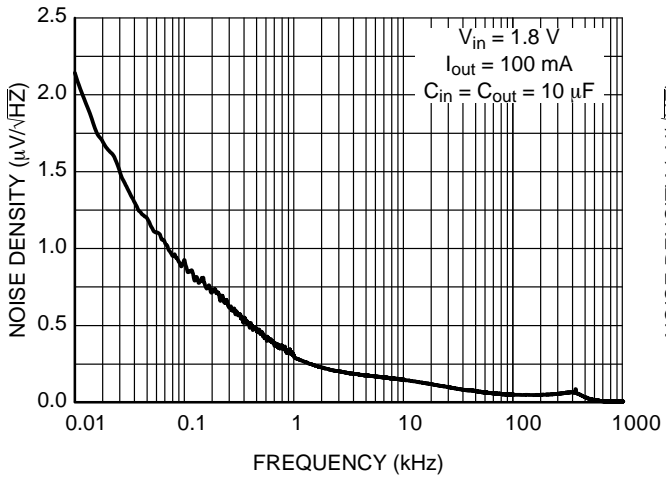

Figure 20. PSRR vs. Frequency at NCP4632xDT33

# NCP4632

## TYPICAL CHARACTERISTICS



**Figure 21. Output Noise Density vs. Frequency at NCP4632xDT08**

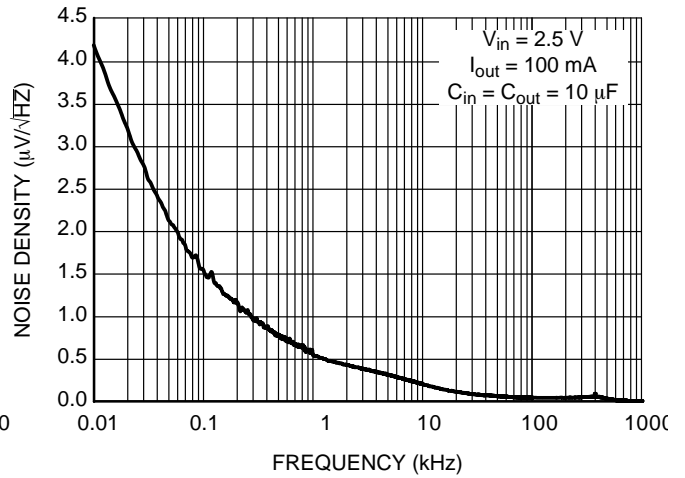

**Figure 22. Output Noise Density vs. Frequency at NCP4632xDT15**

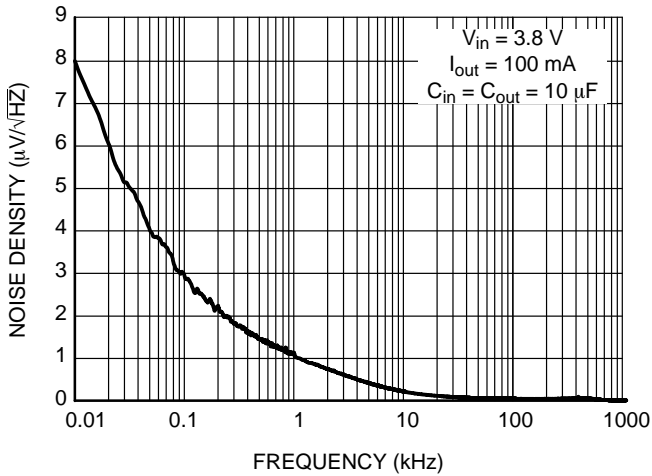

**Figure 23. Output Noise Density vs. Frequency at NCP4632xDT28**

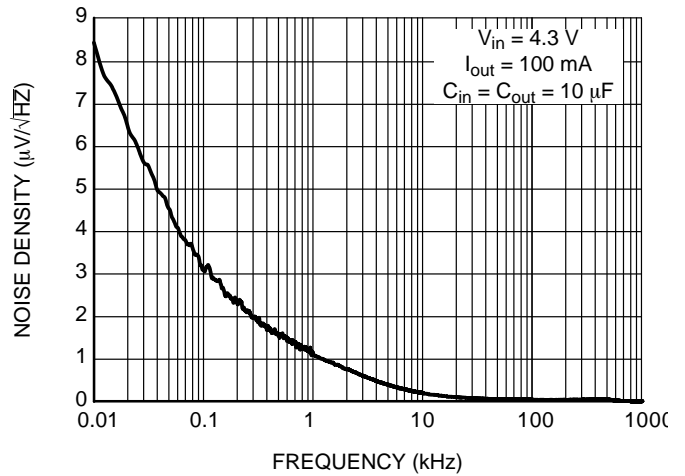

**Figure 24. Output Noise density vs. Frequency at NCP4632xDT33**

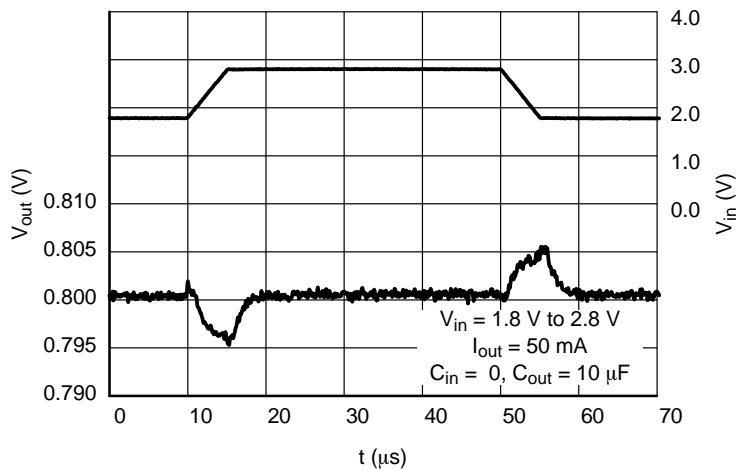

**Figure 25. Line Transient Response at NCP4632xDT08**

# NCP4632

## TYPICAL CHARACTERISTICS

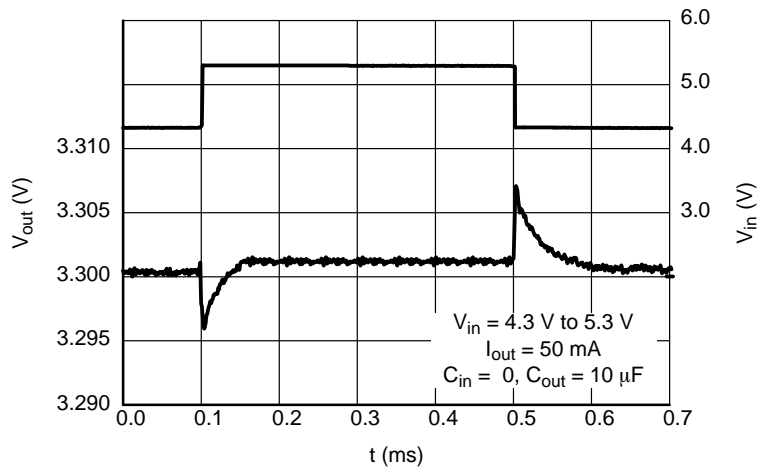

Figure 26. Line Transient Response at NCP4632xDT33

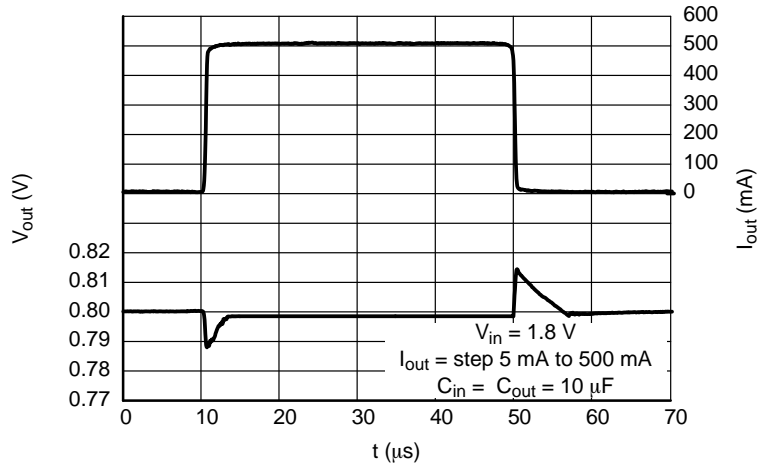

Figure 27. Load Transient Response at NCP4632xDT08

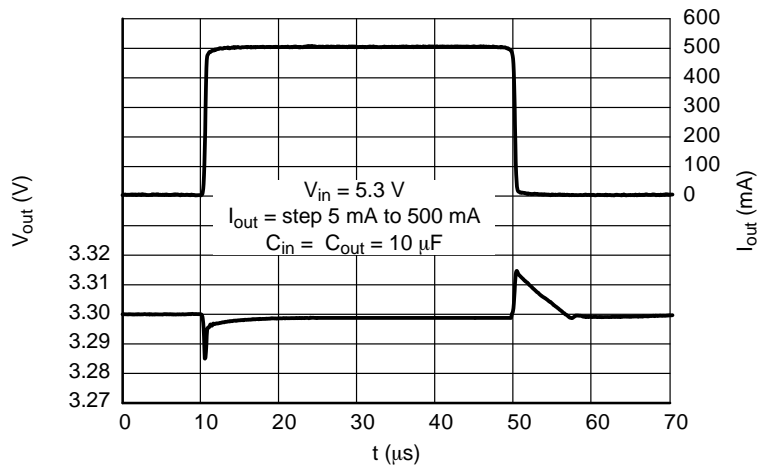

Figure 28. Load Transient Response at NCP4632xDT33



# NCP4632

## TYPICAL CHARACTERISTICS

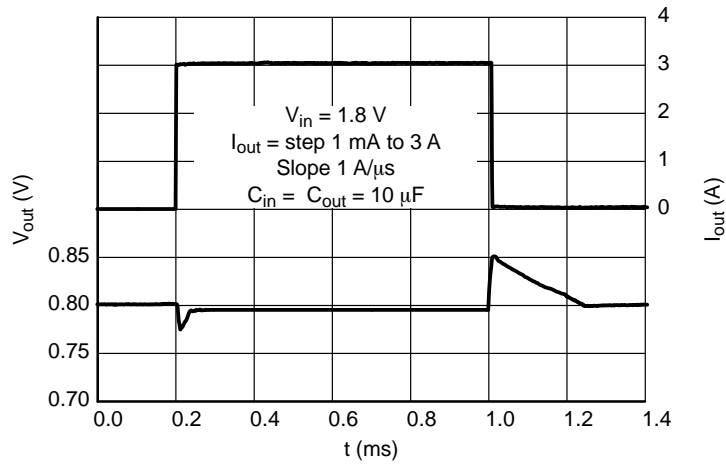

Figure 29. Load Transient Response at NCP4632xDT08

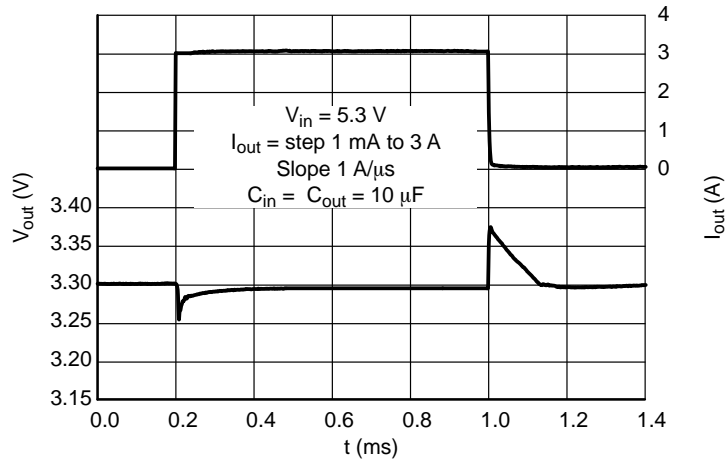

Figure 30. Load Transient Response at NCP4632xDT33

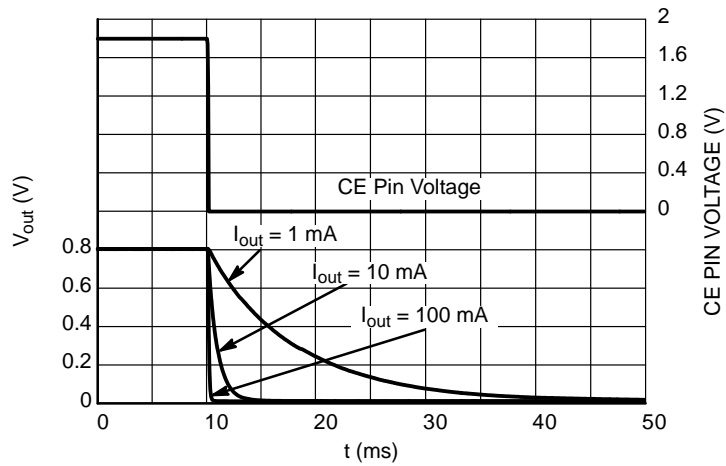

Figure 31. Turn Off with CE pin vs. Output Current at NCP4632BDT08

# NCP4632

## TYPICAL CHARACTERISTICS

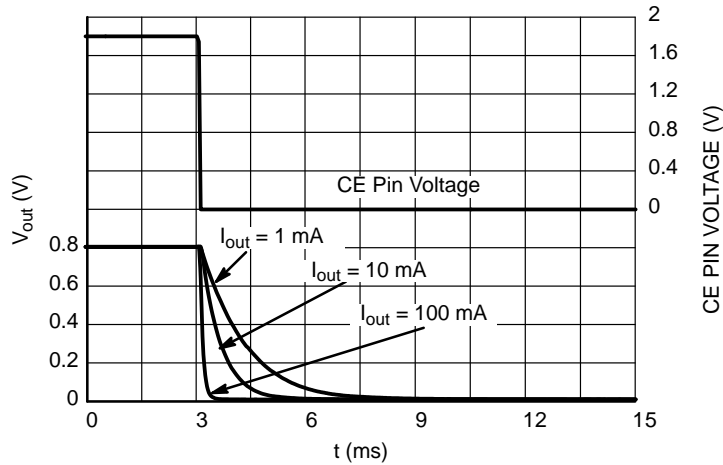

Figure 32. Turn Off with CE pin vs. Output Current at NCP4632DDT08

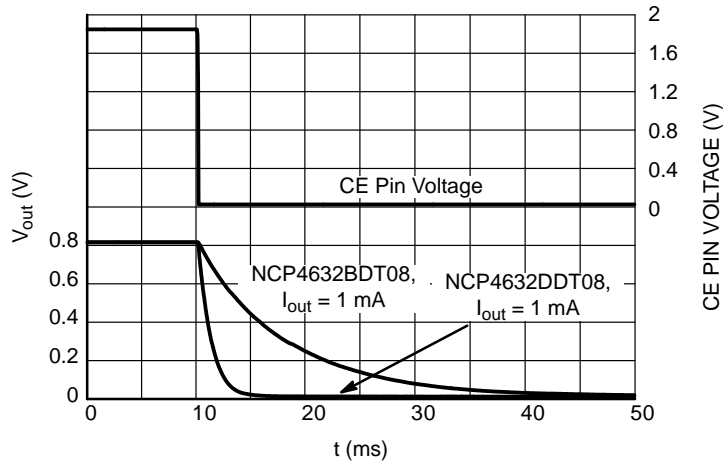

Figure 33. Turn Off with CE pin at NCP4632xDT08,  $I_{out} = 1 \text{ mA}$

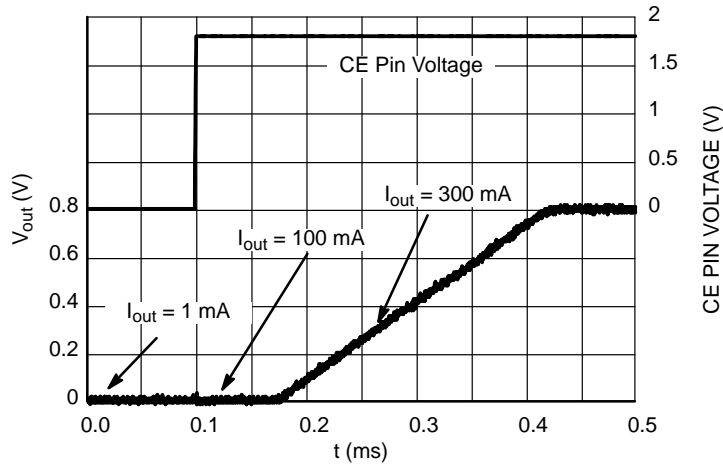

Figure 34. Turn On with CE pin at NCP4632xDT08

# NCP4632

## TYPICAL CHARACTERISTICS

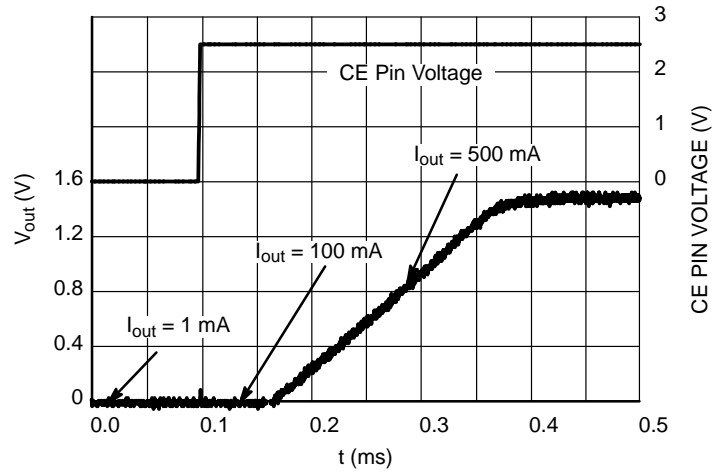

Figure 35. Turn On with CE Pin at NCP4632xDT15

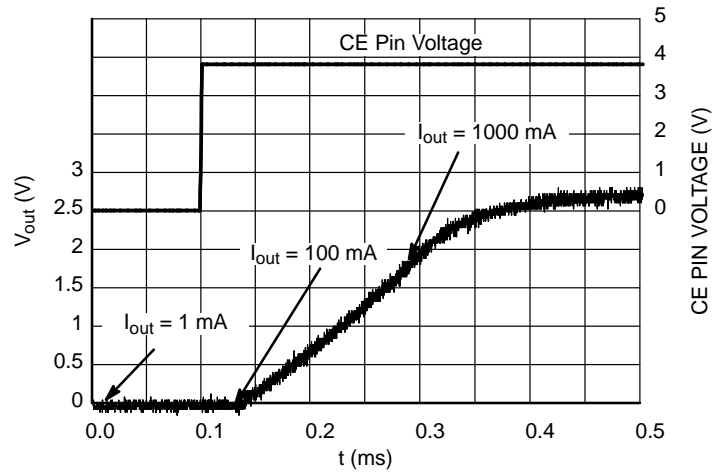

Figure 36. Turn On with CE Pin at NCP4632xDT28

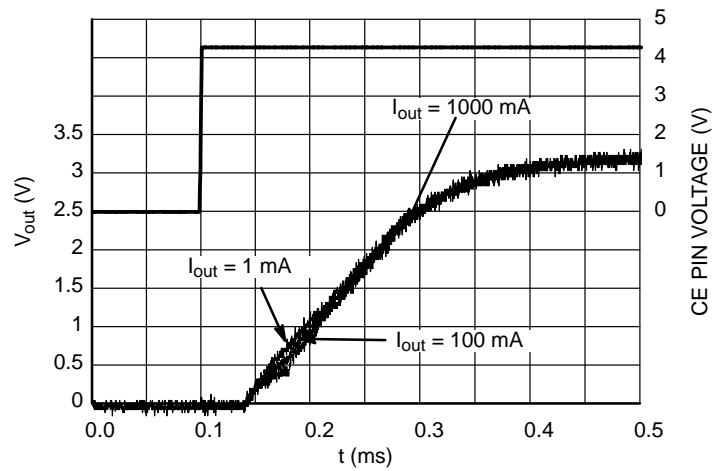

Figure 37. Turn On with CE Pin at NCP4632xDT33

APPLICATION INFORMATION

A typical application circuit for NCP4632 series is shown in Figure 38.

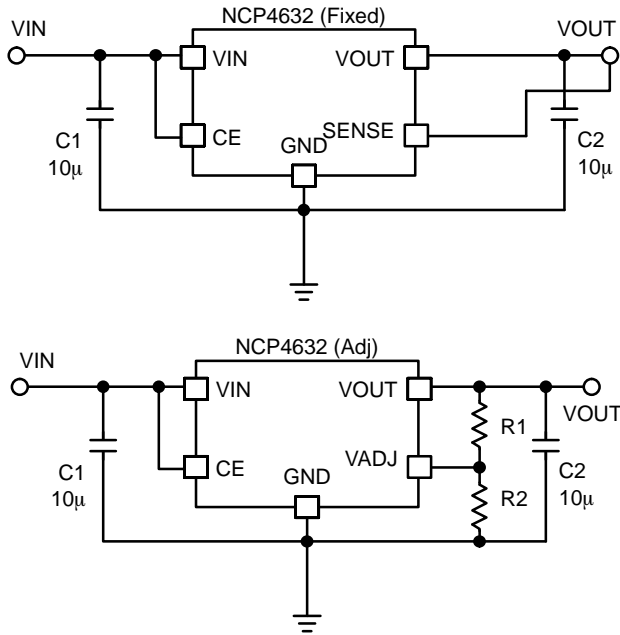

Figure 38. Typical Application Schematic

**Input Decoupling Capacitor (C1)**

A 10 µF ceramic input decoupling capacitor should be connected as close as possible to the input and ground pin of the NCP4632. Higher values and lower ESR improves line transient response.

**Output Decoupling Capacitor (C2)**

A 10 µF ceramic output decoupling capacitor is sufficient to achieve stable operation of the IC. If a tantalum capacitor is used, and its ESR is high, loop oscillation may result. Using multiple ceramic capacitors in parallel should be avoided if possible as this can lead to unstable operation. The Output capacitor should be connected as close as possible to the output and ground pin. Larger capacitance values and lower ESR improves dynamic parameters.

**Enable Operation**

The Enable pin (CE) may be used for turning the regulator on and off. The regulator is switched on when the CE pin voltage is above logic high level. The Enable pin has an internal pull down current source with a 300 nA current capability. If the enable function is not needed, connect CE pin to VIN pin.

**Output Voltage Setting**

For the Adjustable version of the NCP4632, the output voltage can be adjusted by using an external resistor divider. The output voltage can be calculated using Equation 1.

$$V_{OUT} = 0.8 \times \left(1 + \frac{R1}{R2}\right) + R1 \times I_{ADJ} \quad (\text{eq. 1})$$

The current consumption  $I_{ADJ}$  flowing into the ADJ pin can be described by Equation 2.

$$R1 \times I_{ADJ} = V_{SET} \times \frac{R1}{R_{ADJ}} \quad (\text{eq. 2})$$

By choosing  $R1 \ll R_{ADJ}$  ( $R_{ADJ}$  is typically around 1.6 MΩ), this value becomes very small in which case we can omit the term  $R1 \times I_{ADJ}$  in Equation 1. The simplified equation for the output voltage calculation is shown in Equation 3.

$$V_{OUT} = 0.8 \times \left(1 + \frac{R1}{R2}\right) \quad (\text{eq. 3})$$

The resistor divider should be kept to values below 500 kΩ to ensure stability.

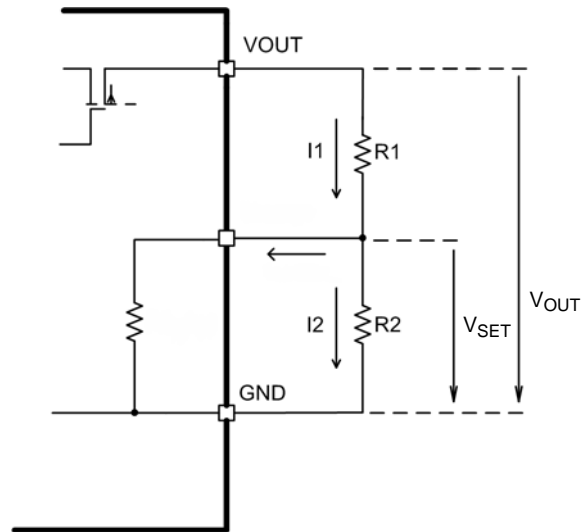

Figure 39. Output Voltage Setting

**Output Discharger**

The D version includes a transistor between VOUT and GND that is used for faster discharging of the output capacitor. This function is activated when the IC goes into disable mode.

**Thermal**

As power across the IC increases, it might become necessary to provide some thermal relief. The maximum power dissipation supported by the device is dependent upon board design and layout. Mounting pad configuration on the PCB, the board material, and also the ambient temperature affect the rate of temperature rise for the part. That is to say, when the device has good thermal conductivity through the PCB, the junction temperature will be relatively low with high power dissipation applications.

# NCP4632

## PCB layout

Make VIN and GND line sufficient. If their impedance is high, noise pickup or unstable operation may result. Connect capacitors C1 and C2 as close as possible to the IC, and make wiring as short as possible.

## Reverse Current Protection

The NCP4632 device include a Reverse Current Protection Circuit, which stops a reverse current flowing from the VOUT pin to the VIN or GND pin when the voltage on VOUT becomes higher than VIN. The reverse current protection circuitry switches the output power device of the

regulator off as soon as VIN drops to < 30 mV above VOUT. In this state, reverse current is restricted to less than 10  $\mu$ A, which flows to ground. As VIN recovers, the power device is switched back on. In order to avoid unstable behavior, there is a 5 mV hysteresis incorporated in the design which will require the dropout to rise above 35 mV before the power device is switched on again. Therefore, the minimum voltage dropout of the device at small output current is limited to 35 mV. Figures 40 and 41 show the diagrams of both operating modes.

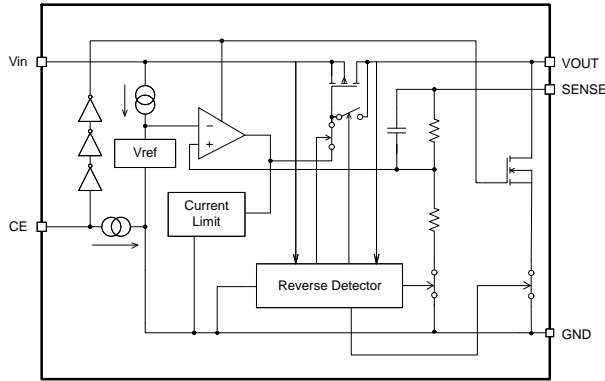

Figure 40. Normal Operating Mode

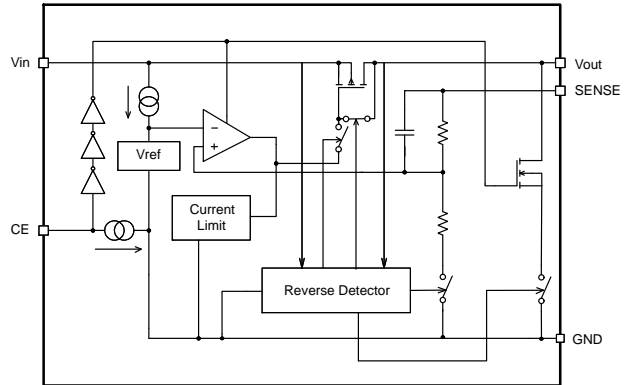

Figure 41. Reverse Operating Mode

## ORDERING INFORMATION

Device	Nominal Output Voltage	Description	Marking	Package	Shipping†
NCP4632DDTADJT5G	Adj	Adjustable, auto discharge	E1J081D	DPAK-5 (Pb-Free)	3000 / Tape & Reel
NCP4632BDT08T5G	0.8 V	W/O Auto discharge	E1J081B	DPAK-5 (Pb-Free)	3000 / Tape & Reel
NCP4632DDT08T5G	0.8 V	Auto discharge	E1J081D	DPAK-5 (Pb-Free)	3000 / Tape & Reel
NCP4632DDT15T5G	1.5 V	Auto discharge	E1J151D	DPAK-5 (Pb-Free)	3000 / Tape & Reel
NCP4632DDT28T5G	2.8 V	Auto discharge	E1J281D	DPAK-5 (Pb-Free)	3000 / Tape & Reel
NCP4632DDT33T5G	3.3 V	Auto discharge	E1J331D	DPAK-5 (Pb-Free)	3000 / Tape & Reel

NOTE: The Adjustable and the 0.8 V fixed voltage option devices are interchangeable and have the same device marking. Evaluation Boards are available for select devices. Consult our website for further details

†For information on tape and reel specifications, including part orientation and tape sizes, please refer to our Tape and Reel Packaging Specifications Brochure, BRD8011/D.

# NCP4632

## PACKAGE DIMENSIONS

### DPAK-5 (TO-252, 5 LEAD) CASE 369AE ISSUE A

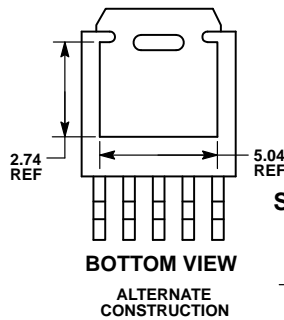
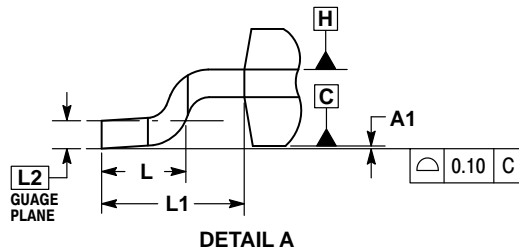
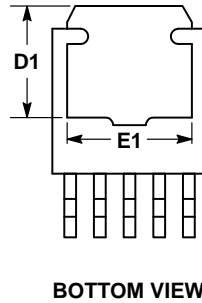
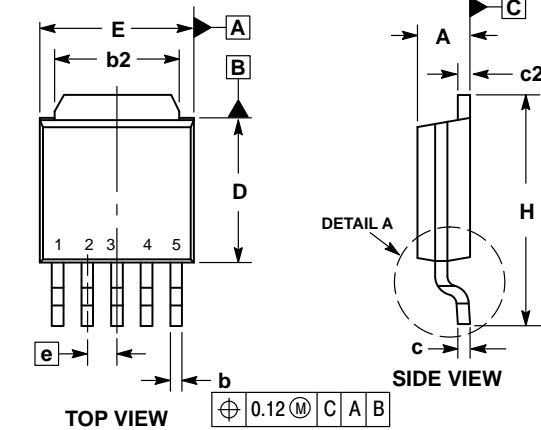

**NOTES:**

1. DIMENSIONING AND TOLERANCING PER ASME Y14.5M, 1994.
2. CONTROLLING DIMENSION: MILLIMETERS.
3. THERMAL PAD CONTOUR OPTIONAL, WITHIN DIMENSIONS SHOWN.
4. DIMENSIONS D AND E DO NOT INCLUDE MOLD FLASH, PROTRUSIONS OR BURRS. MOLD FLASH, PROTRUSIONS OR GATE BURRS SHALL NOT EXCEED 0.15mm PER SIDE.
5. DIMENSIONS D AND E ARE DETERMINED AT THE OUTERMOST EXTREMES OF THE PLASTIC BODY.
6. DATUMS A AND B ARE DETERMINED AT DATUM PLANE H.

MILLIMETERS		
DIM	MIN	MAX
A	2.10	2.50
A1	0.00	0.13
b	0.40	0.60
b2	5.14	5.54
c	0.40	0.60
c2	0.40	0.60
D	5.40	6.30
D1	4.80	5.10
E	6.35	6.80
E1	4.75	5.05
e	1.27 BSC	
H	9.50	10.20
L	1.39	1.78
L1	2.50	2.90
L2	0.51 BSC	

### RECOMMENDED SOLDERING FOOTPRINT\*

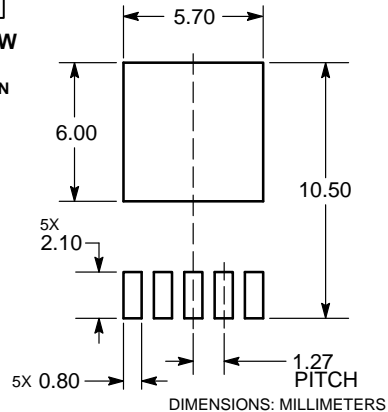

\*For additional information on our Pb-Free strategy and soldering details, please download the ON Semiconductor Soldering and Mounting Techniques Reference Manual, SOLDERRM/D.

ON Semiconductor and are trademarks of Semiconductor Components Industries, LLC dba ON Semiconductor or its subsidiaries in the United States and/or other countries. ON Semiconductor owns the rights to a number of patents, trademarks, copyrights, trade secrets, and other intellectual property. A listing of ON Semiconductor's product/patent coverage may be accessed at [www.onsemi.com/site/pdf/Patent-Marking.pdf](http://www.onsemi.com/site/pdf/Patent-Marking.pdf). ON Semiconductor reserves the right to make changes without further notice to any products herein. ON Semiconductor makes no warranty, representation or guarantee regarding the suitability of its products for any particular purpose, nor does ON Semiconductor assume any liability arising out of the application or use of any product or circuit, and specifically disclaims any and all liability, including without limitation special, consequential or incidental damages. Buyer is responsible for its products and applications using ON Semiconductor products, including compliance with all laws, regulations and safety requirements or standards, regardless of any support or applications information provided by ON Semiconductor. "Typical" parameters which may be provided in ON Semiconductor data sheets and/or specifications can and do vary in different applications and actual performance may vary over time. All operating parameters, including "Typicals" must be validated for each customer application by customer's technical experts. ON Semiconductor does not convey any license under its patent rights nor the rights of others. ON Semiconductor products are not designed, intended, or authorized for use as a critical component in life support systems or any FDA Class 3 medical devices or medical devices with a same or similar classification in a foreign jurisdiction or any devices intended for implantation in the human body. Should Buyer purchase or use ON Semiconductor products for any such unintended or unauthorized application, Buyer shall indemnify and hold ON Semiconductor and its officers, employees, subsidiaries, affiliates, and distributors harmless against all claims, costs, damages, and expenses, and reasonable attorney fees arising out of, directly or indirectly, any claim of personal injury or death associated with such unintended or unauthorized use, even if such claim alleges that ON Semiconductor was negligent regarding the design or manufacture of the part. ON Semiconductor is an Equal Opportunity/Affirmative Action Employer. This literature is subject to all applicable copyright laws and is not for resale in any manner.

### PUBLICATION ORDERING INFORMATION

**LITERATURE FULFILLMENT:**

Literature Distribution Center for ON Semiconductor  
19521 E. 32nd Pkwy, Aurora, Colorado 80011 USA  
Phone: 303-675-2175 or 800-344-3860 Toll Free USA/Canada  
Fax: 303-675-2176 or 800-344-3867 Toll Free USA/Canada  
Email: [orderlit@onsemi.com](mailto:orderlit@onsemi.com)

**N. American Technical Support:** 800-282-9855 Toll Free  
USA/Canada  
**Europe, Middle East and Africa Technical Support:**  
Phone: 421 33 790 2910  
**Japan Customer Focus Center**  
Phone: 81-3-5817-1050

**ON Semiconductor Website:** [www.onsemi.com](http://www.onsemi.com)

**Order Literature:** <http://www.onsemi.com/orderlit>

For additional information, please contact your local Sales Representative