

# Cascadable Silicon Bipolar MMIC Amplifier

## Technical Data

### MSA-0886

#### Features

- **Usable Gain to 5.5 GHz**
- **High Gain:**  
32.5 dB Typical at 0.1 GHz  
22.5 dB Typical at 1.0 GHz
- **Low Noise Figure:**  
3.3 dB Typical at 1.0 GHz
- **Surface Mount Plastic Package**
- **Tape-and-Reel Packaging Option Available<sup>(1)</sup>**

#### Note:

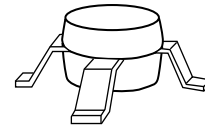
1. Refer to PACKAGING section "Tape-and-Reel Packaging for Semiconductor Devices."

#### Description

The MSA-0886 is a high performance silicon bipolar Monolithic Microwave Integrated Circuit (MMIC) housed in a low cost, surface mount plastic package. This MMIC is designed for use as a general purpose 50 Ω gain block above 0.5 GHz and can be used as a high gain transistor below this frequency. Typical applications include narrow and moderate band IF and RF amplifiers in commercial and industrial applications.

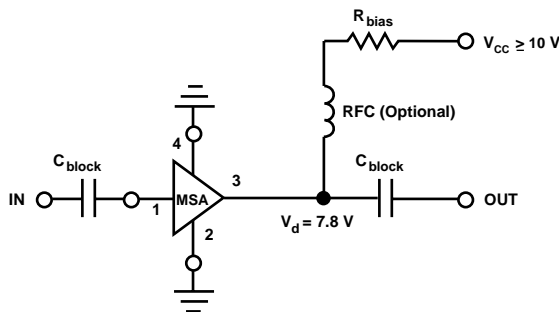
The MSA-series is fabricated using HP's 10 GHz  $f_T$ , 25 GHz  $f_{MAX}$ , silicon bipolar MMIC process which uses nitride self-alignment,

#### 86 Plastic Package



ion implantation, and gold metallization to achieve excellent performance, uniformity and reliability. The use of an external bias resistor for temperature and current stability also allows bias flexibility.

#### Typical Biasing Configuration



## MSA-0886 Absolute Maximum Ratings

Parameter	Absolute Maximum <sup>[1]</sup>
Device Current	65 mA
Power Dissipation <sup>[2,3]</sup>	500 mW
RF Input Power	+13 dBm
Junction Temperature	150°C
Storage Temperature	-65°C to 150°C

**Thermal Resistance<sup>[2,4]</sup>:**

$$\theta_{jc} = 140^{\circ}\text{C/W}$$

### Notes:

1. Permanent damage may occur if any of these limits are exceeded.
2.  $T_{\text{CASE}} = 25^{\circ}\text{C}$ .
3. Derate at  $7.1 \text{ mW/}^{\circ}\text{C}$  for  $T_{\text{C}} > 80^{\circ}\text{C}$ .
4. See MEASUREMENTS section "Thermal Resistance" for more information.

## Electrical Specifications<sup>[1]</sup>, $T_{\text{A}} = 25^{\circ}\text{C}$

Symbol	Parameters and Test Conditions: $I_{\text{d}} = 36 \text{ mA}$ , $Z_0 = 50 \Omega$	Units	Min.	Typ.	Max.
GP	Power Gain ( $ S_{21} ^2$ ) f = 0.1 GHz f = 1.0 GHz	dB	20.5	32.5 22.5	
VSWR	Input VSWR f = 0.1 to 3.0 GHz			2.1:1	
	Output VSWR f = 0.1 to 3.0 GHz			1.9:1	
NF	50 $\Omega$ Noise Figure f = 1.0 GHz	dB		3.3	
P <sub>1</sub> dB	Output Power at 1 dB Gain Compression f = 1.0 GHz	dBm		12.5	
IP <sub>3</sub>	Third Order Intercept Point f = 1.0 GHz	dBm		27.0	
t <sub>D</sub>	Group Delay f = 1.0 GHz	psec		140	
V <sub>d</sub>	Device Voltage	V	6.2	7.8	9.4
dV/dT	Device Voltage Temperature Coefficient	mV/°C		-17.0	

### Note:

1. The recommended operating current range for this device is 20 to 40 mA. Typical performance as a function of current is on the following page.

## Part Number Ordering Information

Part Number	No. of Devices	Container
MSA-0886-TR1	1000	7" Reel
MSA-0886-BLK	100	Antistatic Bag

For more information, see "Tape and Reel Packaging for Semiconductor Devices".

### MSA-0886 Typical Scattering Parameters<sup>[1]</sup> ( $Z_0 = 50 \Omega$ , $T_A = 25^\circ\text{C}$ , $I_d = 36 \text{ mA}$ )

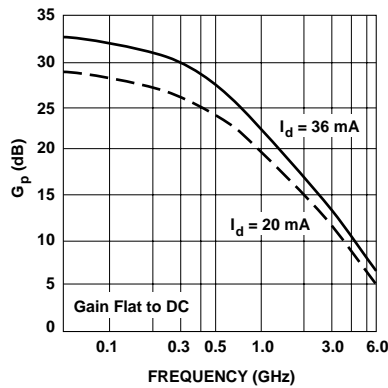
Freq. GHz	S <sub>11</sub>		S <sub>21</sub>			S <sub>12</sub>			S <sub>22</sub>		k
	Mag	Ang	dB	Mag	Ang	dB	Mag	Ang	Mag	Ang	
0.1	.63	-22	32.5	42.12	160	-36.7	.015	54	.62	-24	0.68
0.2	.56	-41	31.3	36.68	143	-33.9	.020	50	.55	-46	0.64
0.4	.43	-69	28.6	26.94	119	-29.1	.035	52	.43	-79	0.69
0.6	.35	-88	26.4	20.89	104	-27.0	.045	49	.34	-103	0.77
0.8	.30	-104	24.2	16.21	93	-25.3	.054	50	.29	-124	0.83
1.0	.27	-116	22.4	13.20	83	-24.2	.062	49	.26	-139	0.87
1.5	.27	-144	19.2	9.15	65	-21.6	.083	46	.23	-172	0.93
2.0	.31	-166	16.7	6.84	49	-19.5	.105	41	.22	163	0.96
2.5	.35	178	14.8	5.50	38	-17.9	.128	36	.21	149	0.96
3.0	.40	162	12.9	4.41	25	-17.4	.135	30	.20	132	1.01
3.5	.45	149	11.4	3.72	13	-16.8	.145	25	.19	124	1.02
4.0	.51	137	9.9	3.14	1	-16.1	.157	19	.18	121	1.01
5.0	.61	116	7.3	2.31	-22	-15.7	.164	10	.17	130	1.00
6.0	.68	100	4.6	1.69	-42	-15.2	.173	4	.23	143	0.95

**Note:**

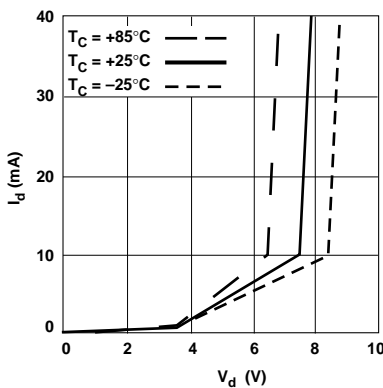
1. A model for this device is available in the DEVICE MODELS section.

### Typical Performance, $T_A = 25^\circ\text{C}$

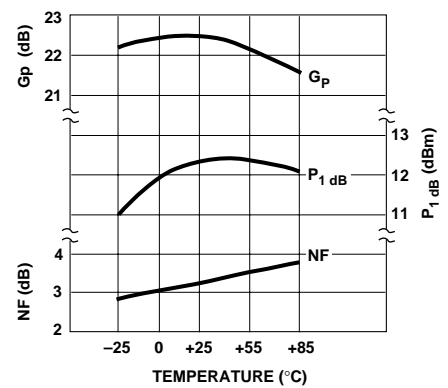
(unless otherwise noted)



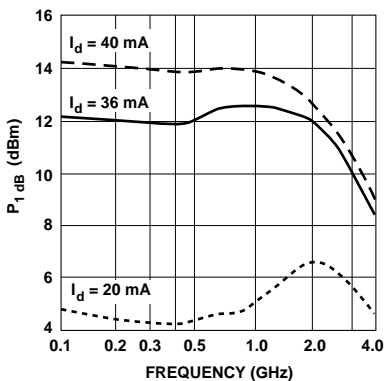
**Figure 1. Typical Power Gain vs. Frequency,  $I_d = 36 \text{ mA}$ .**



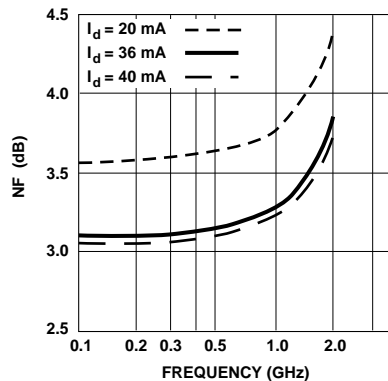
**Figure 2. Device Current vs. Voltage.**



**Figure 3. Output Power at 1 dB Gain Compression, NF and Power Gain vs. Case Temperature,  $f = 1.0 \text{ GHz}$ ,  $I_d = 36 \text{ mA}$ .**

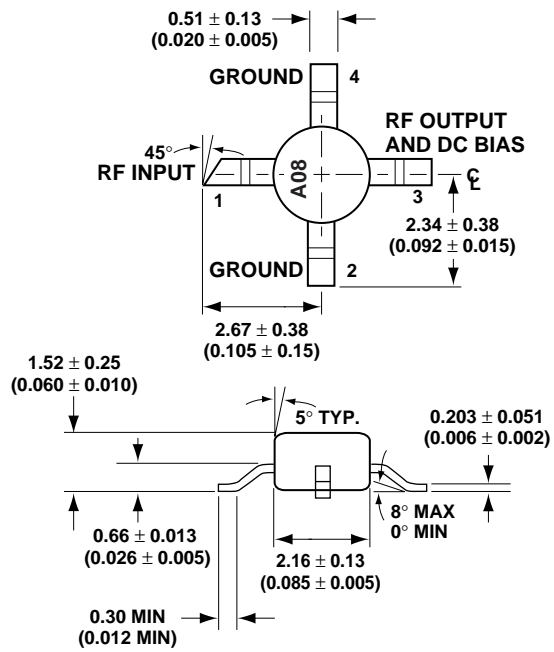


**Figure 4. Output Power at 1 dB Gain Compression vs. Frequency.**



**Figure 5. Noise Figure vs. Frequency.**

## 86 Plastic Package Dimensions



DIMENSIONS ARE IN MILLIMETERS (INCHES)