

MRA4003T3 Series

Surface Mount Standard Recovery Power Rectifier

SMA Power Surface Mount Package

Features construction with glass passivation. Ideally suited for surface mounted Automotive application.

- Compact Package with J-Bend Leads Ideal for Automated Handling
- Stable, High Temperature, Glass Passivated Junction

Mechanical Characteristics

- Case: Molded Epoxy
Epoxy meets UL 94 V-0 @ 0.125 in
- Weight: 70 mg (Approximately)
- Finish: All External Surfaces are Corrosion Resistant and Terminal Leads are Readily Solderable
- Lead and Mounting Surface Temperature for Soldering Purposes: 260°C Max. for 10 seconds in Solder Bath
- Polarity: Band in Plastic Body Indicates Cathode Lead
- Marking: MRA4003T3 = R13
MRA4004T3 = R14
MRA4005T1 = R15
MRA4005T3 = R15
MRA4006T3 = R16
MRA4007T3 = R17

ORDERING INFORMATION

Device	Package	Shipping†
MRA4003T3	SMA	5000/Tape & Reel
MRA4003T3G	SMA (Pb-Free)	5000/Tape & Reel
MRA4004T3	SMA	5000/Tape & Reel
MRA4004T3G	SMA (Pb-Free)	5000/Tape & Reel
MRA4005T1	SMA	1500/Tape & Reel
MRA4005T3	SMA	5000/Tape & Reel
MRA4006T3	SMA	5000/Tape & Reel
MRA4007T3	SMA	5000/Tape & Reel
MRA4007T3G	SMA (Pb-Free)	5000/Tape & Reel

†For information on tape and reel specifications, including part orientation and tape sizes, please refer to our Tape and Reel Packaging Specifications Brochure, BRD8011/D.

MAXIMUM RATINGS

Please See the Table on the Following Page



ON Semiconductor®

<http://onsemi.com>

STANDARD RECOVERY
RECTIFIERS
1.0 AMPERES
300-1000 VOLTS



CASE 403D
SMA
PLASTIC

MARKING DIAGRAM



R1x = Specific Device Code
A = Assembly Location
L = Wafer Lot
Y = Year
W = Work Week
▪ = Pb-Free Package

MRA4003T3 Series

MAXIMUM RATINGS

Rating	Symbol	Value					Unit
		MRA4003T3	MRA4004T3	MRA4005T1, MRA4005T3	MRA4006T3	MRA4007T3	
Peak Repetitive Reverse Voltage Working Peak Reverse Voltage DC Blocking Voltage	V_{RRM} V_{RWM} V_R	300	400	600	800	1000	Volts
Avg. Rectified Forward Current (At Rated V_R , $T_L = 150^\circ\text{C}$)	I_O	1					Amp
Peak Repetitive Forward Current (At Rated V_R , Square Wave, 20 kHz, $T_L = 150^\circ\text{C}$)	I_{FRM}	2					Amps
Non-Repetitive Peak Surge Current (Surge applied at rated load conditions, halfwave, single phase, 60 Hz)	I_{FSM}	30					Amps
Storage/Operating Case Temperature	T_{stg} , T_C	-55 to 150					$^\circ\text{C}$
Operating Junction Temperature	T_J	-55 to 175					$^\circ\text{C}$

Maximum ratings are those values beyond which device damage can occur. Maximum ratings applied to the device are individual stress limit values (not normal operating conditions) and are not valid simultaneously. If these limits are exceeded, device functional operation is not implied, damage may occur and reliability may be affected.

THERMAL CHARACTERISTICS

Characteristic	Symbol	Value	Unit
Thermal Resistance, Junction-to-Lead (Note 1)	$R_{\theta JL}$	16.2	$^\circ\text{C}/\text{W}$
Thermal Resistance, Junction-to-Ambient (Note 2)	$R_{\theta JA}$	88.3	$^\circ\text{C}/\text{W}$

ELECTRICAL CHARACTERISTICS

Characteristic	Symbol	Value		Unit
		$T_J = 25^\circ\text{C}$	$T_J = 100^\circ\text{C}$	
Maximum Instantaneous Forward Voltage (Note 3) ($I_F = 1\text{ A}$) ($I_F = 2\text{ A}$)	V_F	1.1 1.18	1.04 1.12	Volts
Maximum Instantaneous Reverse Current (at rated DC voltage)	I_R	10	50	μA

1. Minimum Pad Size
2. 1 inch Pad Size
3. Pulse Test: Pulse Width $\leq 250\ \mu\text{s}$, Duty Cycle $\leq 2\%$.

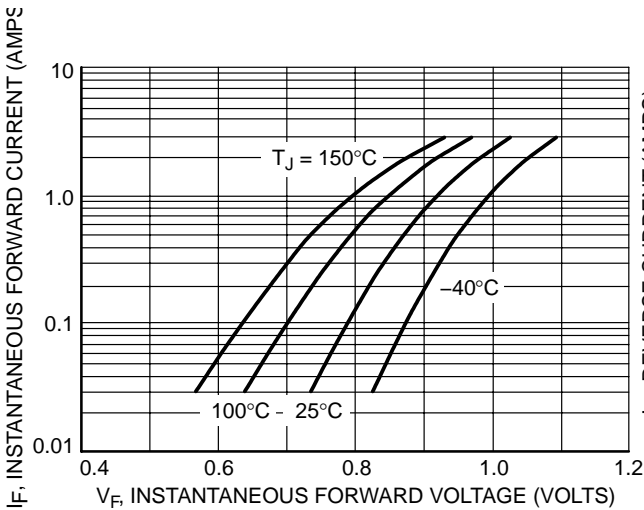

Figure 1. Typical Forward Voltage

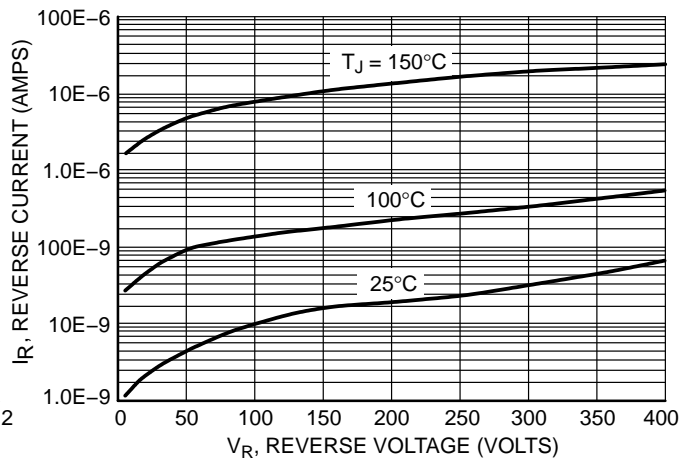

Figure 2. Typical Reverse Current

MRA4003T3 Series

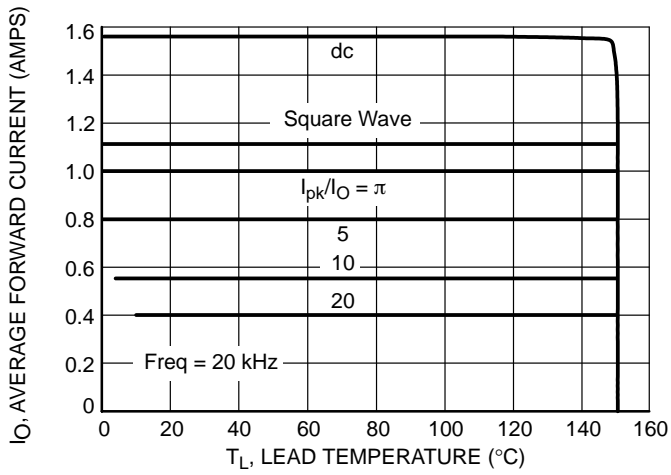

Figure 3. Current Derating per Leg

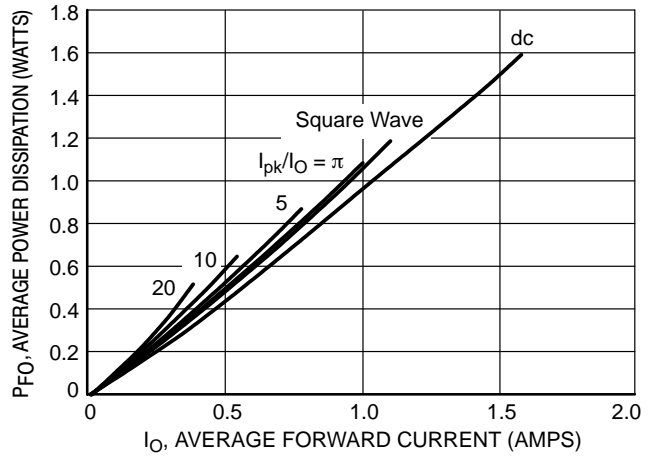

Figure 4. Forward Power Dissipation per Leg

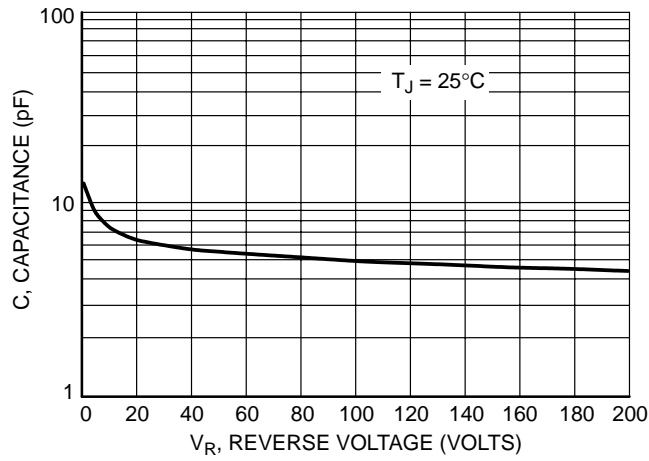

Figure 5. Capacitance

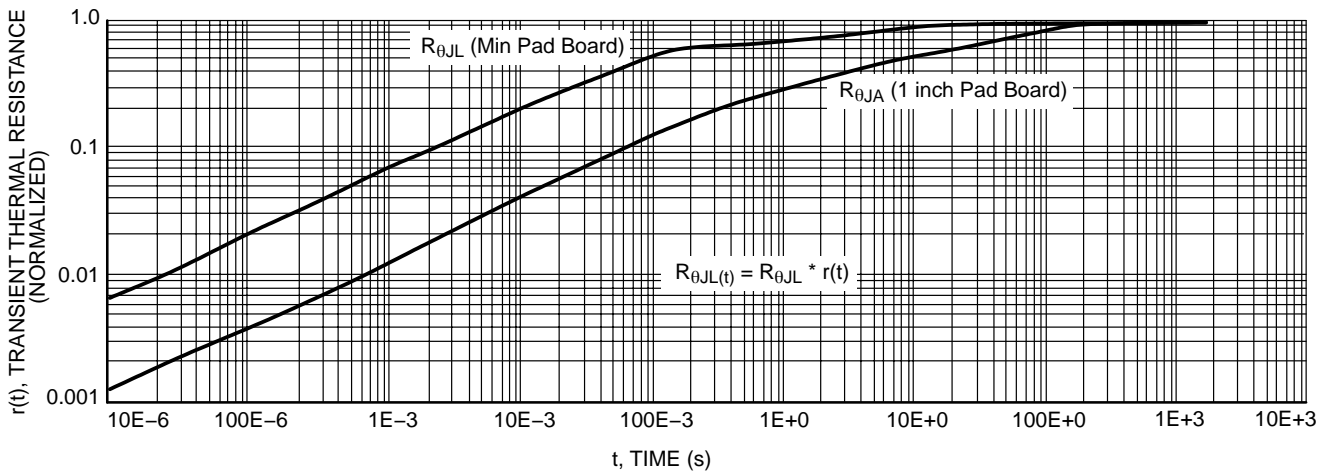
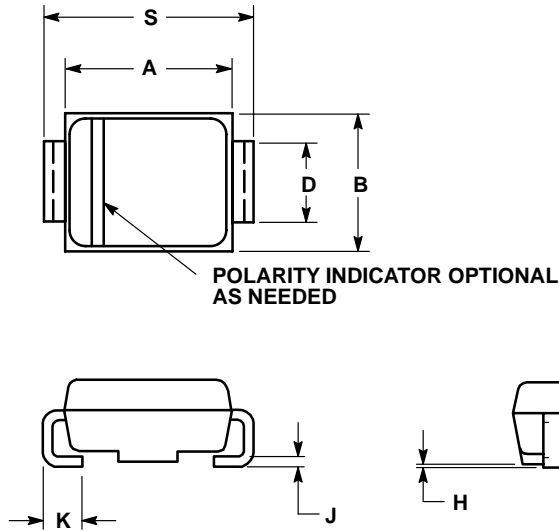

Figure 6. Thermal Response

MRA4003T3 Series

PACKAGE DIMENSIONS

SMA PLASTIC PACKAGE CASE 403D-02 ISSUE A



NOTES:

1. DIMENSIONING AND TOLERANCING PER ANSI Y14.5M, 1982.
2. CONTROLLING DIMENSION: INCH.
3. 403D-01 OBSOLETE, NEW STANDARD IS 403D-02.

DIM	INCHES		MILLIMETERS	
	MIN	MAX	MIN	MAX
A	0.160	0.180	4.06	4.57
B	0.090	0.115	2.29	2.92
C	0.075	0.095	1.91	2.41
D	0.050	0.064	1.27	1.63
H	0.002	0.006	0.05	0.15
J	0.006	0.016	0.15	0.41
K	0.030	0.060	0.76	1.52
S	0.190	0.220	4.83	5.59

ON Semiconductor and  are registered trademarks of Semiconductor Components Industries, LLC (SCILLC). SCILLC reserves the right to make changes without further notice to any products herein. SCILLC makes no warranty, representation or guarantee regarding the suitability of its products for any particular purpose, nor does SCILLC assume any liability arising out of the application or use of any product or circuit, and specifically disclaims any and all liability, including without limitation special, consequential or incidental damages. "Typical" parameters which may be provided in SCILLC data sheets and/or specifications can and do vary in different applications and actual performance may vary over time. All operating parameters, including "Typicals" must be validated for each customer application by customer's technical experts. SCILLC does not convey any license under its patent rights nor the rights of others. SCILLC products are not designed, intended, or authorized for use as components in systems intended for surgical implant into the body, or other applications intended to support or sustain life, or for any other application in which the failure of the SCILLC product could create a situation where personal injury or death may occur. Should Buyer purchase or use SCILLC products for any such unintended or unauthorized application, Buyer shall indemnify and hold SCILLC and its officers, employees, subsidiaries, affiliates, and distributors harmless against all claims, costs, damages, and expenses, and reasonable attorney fees arising out of, directly or indirectly, any claim of personal injury or death associated with such unintended or unauthorized use, even if such claim alleges that SCILLC was negligent regarding the design or manufacture of the part. SCILLC is an Equal Opportunity/Affirmative Action Employer. This literature is subject to all applicable copyright laws and is not for resale in any manner.

PUBLICATION ORDERING INFORMATION

LITERATURE FULFILLMENT:

Literature Distribution Center for ON Semiconductor
P.O. Box 61312, Phoenix, Arizona 85082-1312 USA
Phone: 480-829-7710 or 800-344-3860 Toll Free USA/Canada
Fax: 480-829-7709 or 800-344-3867 Toll Free USA/Canada
Email: orderlit@onsemi.com

N. American Technical Support: 800-282-9855 Toll Free USA/Canada

Japan: ON Semiconductor, Japan Customer Focus Center
2-9-1 Kamimeguro, Meguro-ku, Tokyo, Japan 153-0051
Phone: 81-3-5773-3850

ON Semiconductor Website: <http://onsemi.com>

Order Literature: <http://www.onsemi.com/litorder>

For additional information, please contact your local Sales Representative.