

Pb Free Plating Product

MJL21194G



200 Watt Silicon Epitaxial Planar NPN Type Power Transistor

DESCRIPTION

- With TO-3PL-SQ(TO-3PBL/TO-3BPL) pkg
- Complement to type MJL21193G

APPLICATIONS

- Power amplifier applications
- Recommended for 100W high fidelity audio frequency amplifier output stage

PINNING

PIN	DESCRIPTION
E	Emitter
C	Collector;connected to mounting base
B	Base

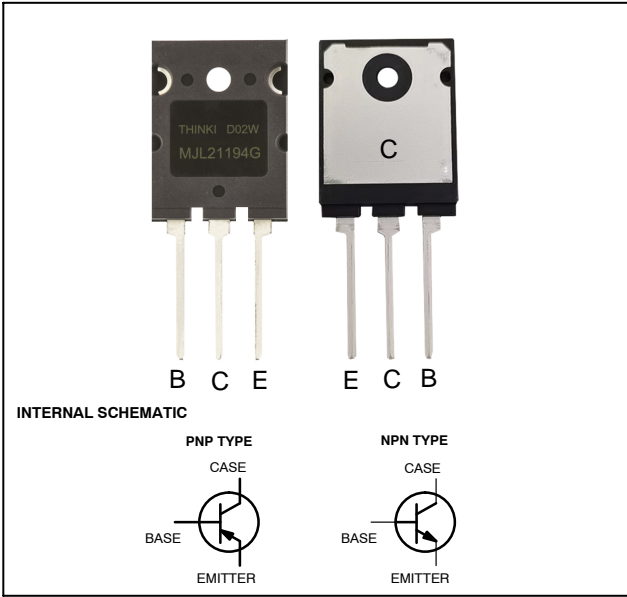

Absolute Maximum Ratings(Ta=25°C)

Characteristics	Symbol	Rating	Unit
Collector-base voltage	V_{CBO}	400	V
Collector-emitter voltage	V_{CEO}	250	V
Emitter-base voltage	V_{EBO}	5	V
Collector current	I_C	16	A
Base current	I_B	5	A
Collector power dissipation(Tc=25°C)	P_C	200	W
Junction temperature	T_j	150	°C
Storage temperature range	T_{STG}	-55~150	°C

Electrical Characteristics (Tc=25°C):

Characteristics	Symbol	Test Condition	Min	Typ	Max	Unit
Collector cut-off current	I_{CBO}	$V_{CB}=250V; I_E=0$			10	μA
Emitter cut-off current	I_{EBO}	$V_{EB}=5V; I_C=0$			10	μA
Collector-emitter breakdown voltage	$V_{(BR)CEO}$	$I_C=50mA, I_B=0$	250			V
Dc current gain	h_{FE}	$V_{CE}=5V; I_C=8A;$	20		80	
	$h_{FE(2)}$	$V_{CE}=5V; I_C=16A;$	8			
Collector-emitter saturation voltage	$V_{CE(sat)}$	$I_C=8A; I_B=0.8A$			1.4	V
	$V_{CE(sat)}$	$I_C=16A; I_B=3.2A$			4	V
Base-emitter voltage	V_{BE}	$V_{CE}=5V; I_C=8A$			2.2	V
Transition frequency	f_T	$V_{CE}=10V; I_C=1A$	4			MHz

Symbol	Parameter	Typ	Units
$R_{\theta JC}$	Junction-to-Case	0.63	$^{\circ}C/W$

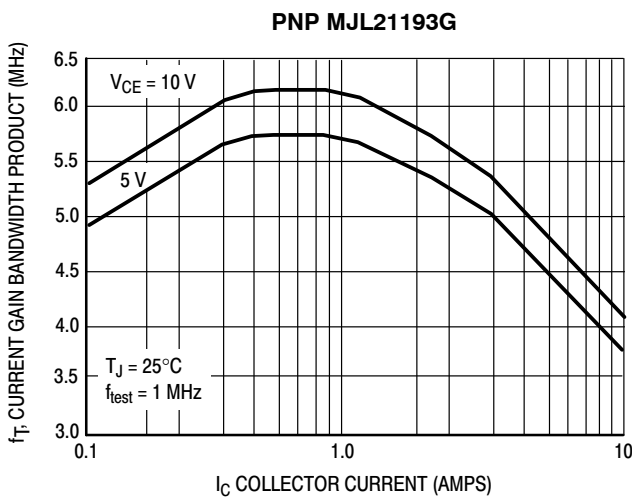

Figure 1. Typical Current Gain Bandwidth Product

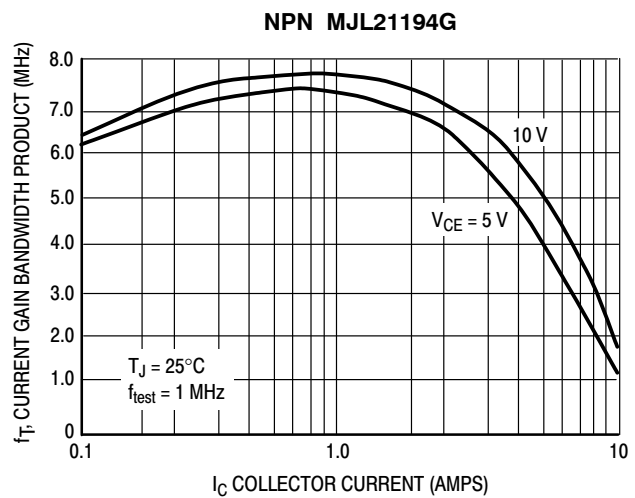

Figure 2. Typical Current Gain Bandwidth Product

TYPICAL CHARACTERISTICS

PNP MJL21193G

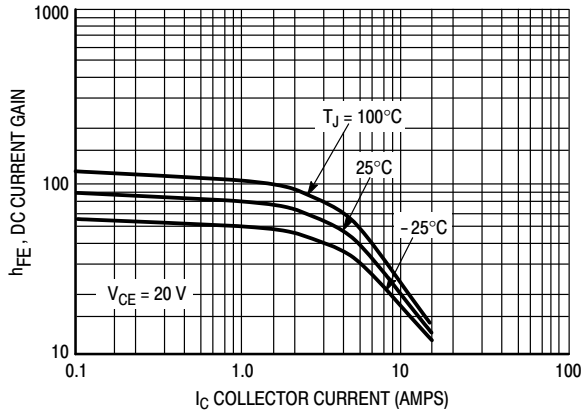

Figure 3. DC Current Gain, $V_{CE} = 20\text{ V}$

NPN MJL21194G

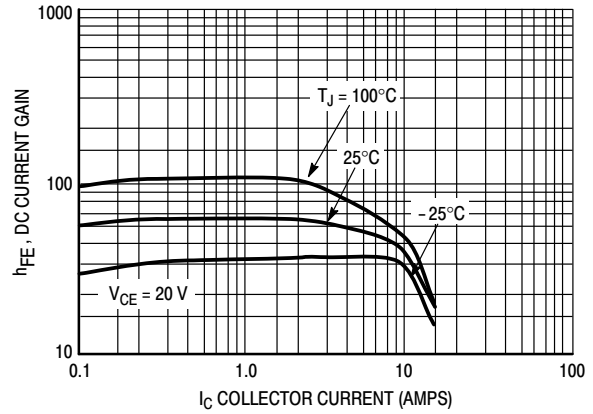

Figure 4. DC Current Gain, $V_{CE} = 20\text{ V}$

PNP MJL21193G

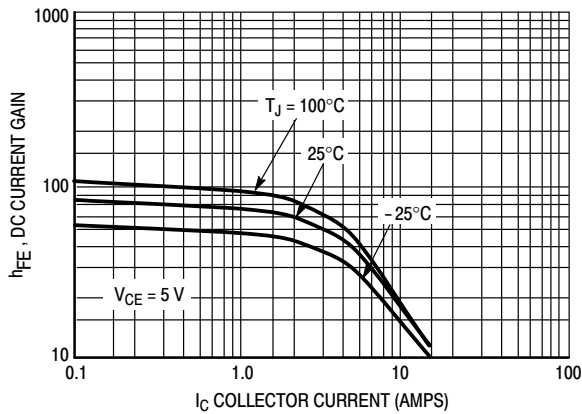

Figure 5. DC Current Gain, $V_{CE} = 5\text{ V}$

NPN MJL21194G

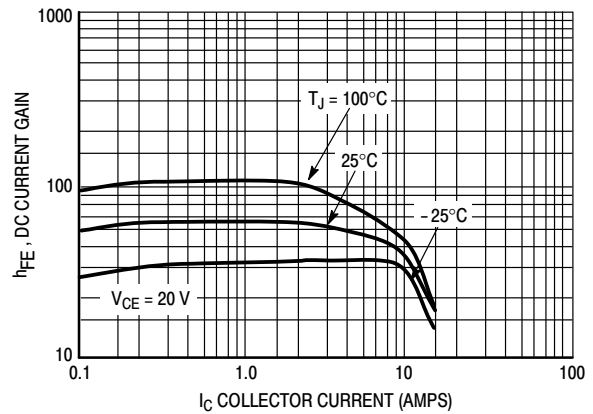

Figure 6. DC Current Gain, $V_{CE} = 5\text{ V}$

PNP MJL21193G

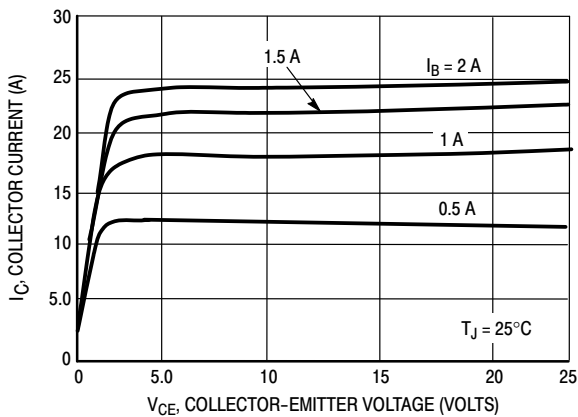

Figure 7. Typical Output Characteristics

NPN MJL21194G

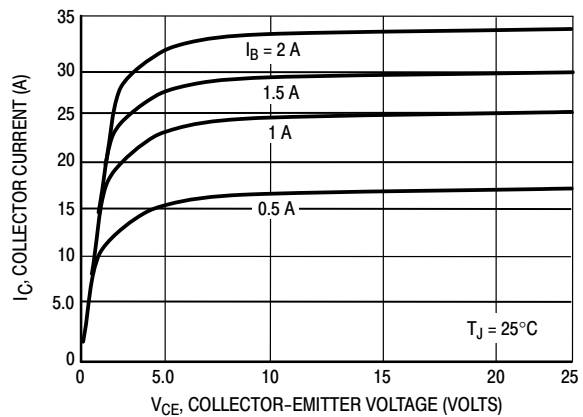

Figure 8. Typical Output Characteristics

TYPICAL CHARACTERISTICS

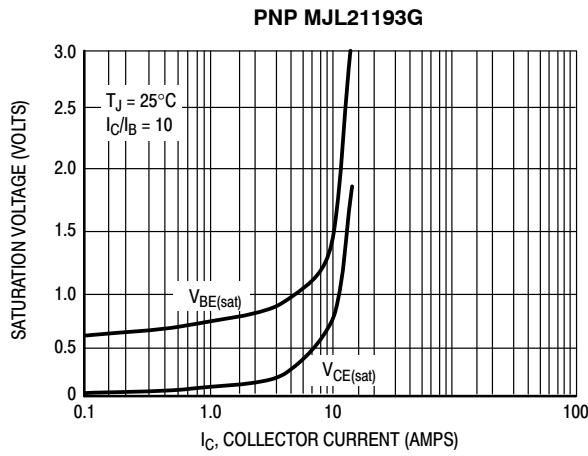

Figure 9. Typical Saturation Voltages

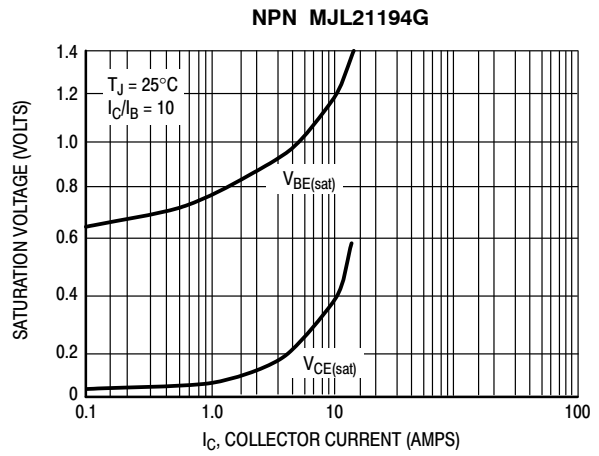

Figure 10. Typical Saturation Voltages

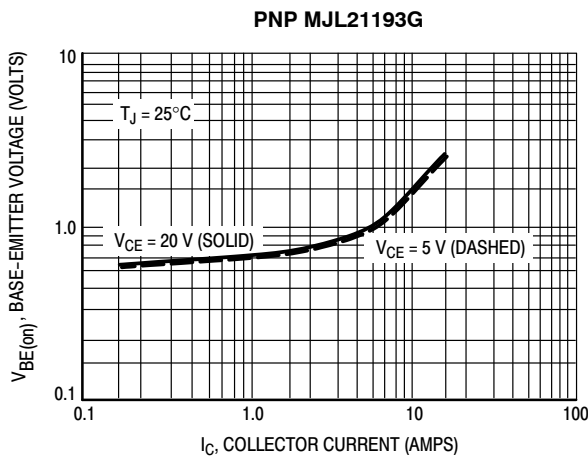

Figure 11. Typical Base-Emitter Voltage

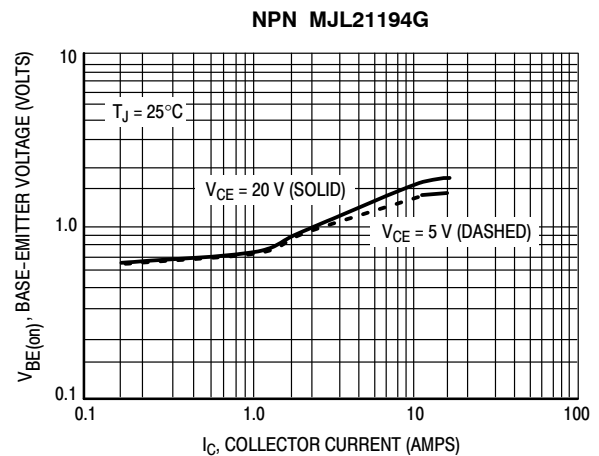

Figure 12. Typical Base-Emitter Voltage

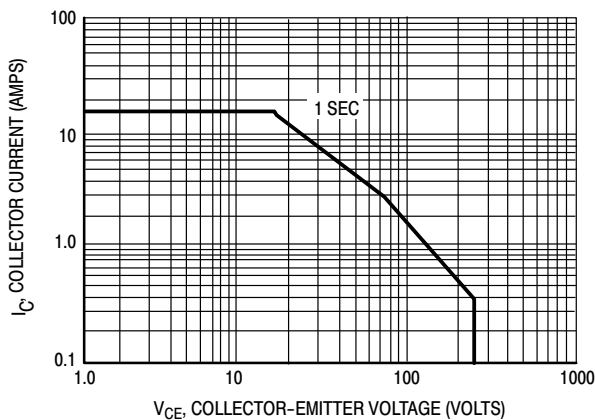

Figure 13. Active Region Safe Operating Area

There are two limitations on the power handling ability of a transistor; average junction temperature and secondary breakdown. Safe operating area curves indicate $I_C - V_{CE}$ limits of the transistor that must be observed for reliable operation; i.e., the transistor must not be subjected to greater dissipation than the curves indicate.

The data of Figure 13 is based on $T_{J(pk)} = 150^\circ\text{C}$; T_C is variable depending on conditions. At high case temperatures, thermal limitations will reduce the power than can be handled to values less than the limitations imposed by second breakdown.

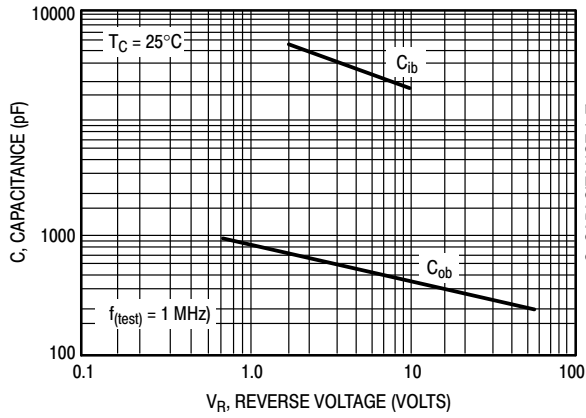

Figure 14. MJL21193G Typical Capacitance

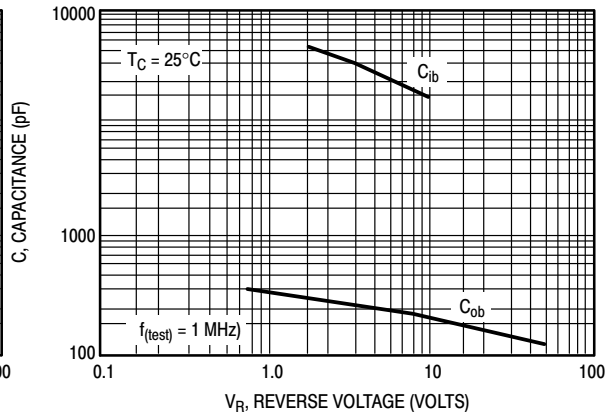

Figure 15. MJL21194G Typical Capacitance

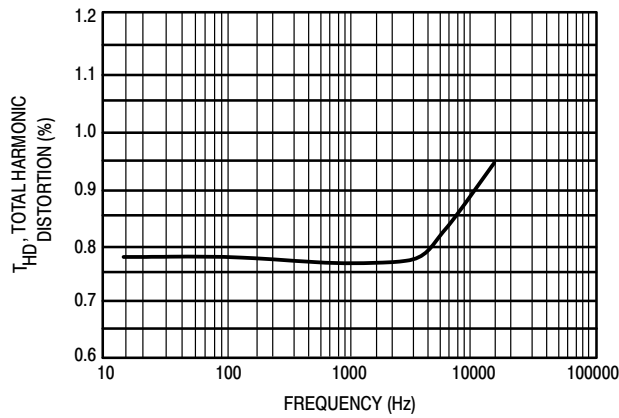

Figure 16. Typical Total Harmonic Distortion

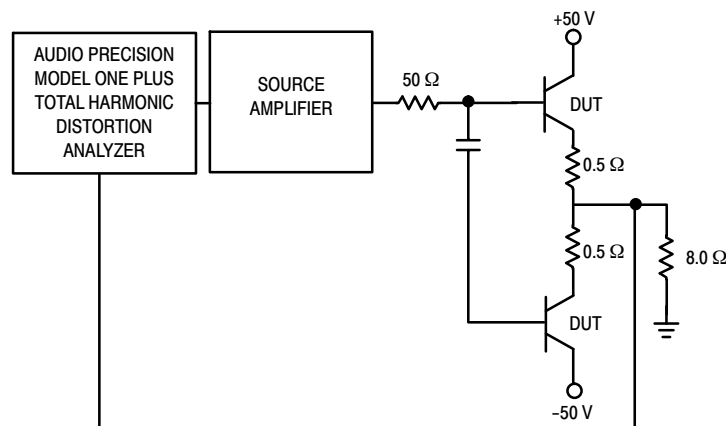
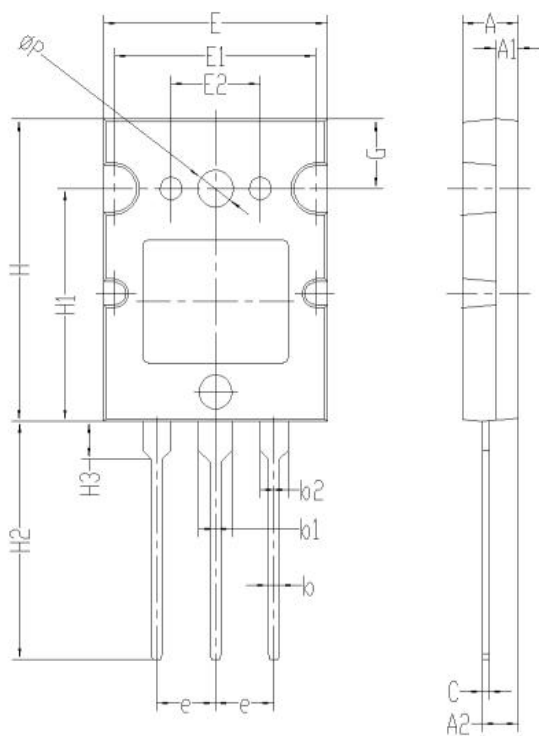

Figure 17. Total Harmonic Distortion Test Circuit

THINKI TO-3PL-SQ(TO-3PBL/TO-3BPL) Package Outline



Symbol	Dimensions (millimeters)	
	Min.	Max.
A	4.80	5.20
A1	1.80	2.20
A2	3.00	3.40
b	0.80	1.20
b1	2.80	3.20
b2	2.30	2.70
c	0.40	0.80
e	5.25	5.65
E	19.8	20.2
E1	17.8	18.2
E2	7.8	8.2
H	25.8	26.2
H1	19.8	20.2
H2	20.0	21.0
H3	3.05	3.45
G	5.80	6.20
ϕP	3.10	3.50
J	4.80	5.20
K	1.80	2.20