Dual Ultra-Low Power Op Amp in SOT-23-8

Features

- 8-Pin SOT-23 Package
- 3 MHz Gain-Bandwidth Product
- 5 MHz, -3 dB Bandwidth
- 31 μ A Supply Current
- Rail-to-Rail Output
- Ground Sensing at Input (Common-Mode-to-GND)
- Drives Large Capacitive Loads
- Unity Gain Stable

Applications

- Portable Equipment
- Medical Instruments
- PDAs
- Pagers
- Cordless Phones
- Consumer Electronics

General Description

The MIC862 is a dual low-power operational amplifier in an SOT23-8 package. It is designed to operate in the 2V to 5V range, rail-to-rail output, with input common-mode to ground. The MIC862 provides 3 MHz gain-bandwidth product while consuming only 31 μ A supply current per channel.

With low supply voltage and 8-lead SOT-23 packaging, MIC862 provides two channels as general-purpose amplifiers for portable and battery-powered applications. Its package provides the maximum performance available while maintaining an extremely slim form factor. The minimal power consumption of this IC maximizes the battery life potential.

Package Type

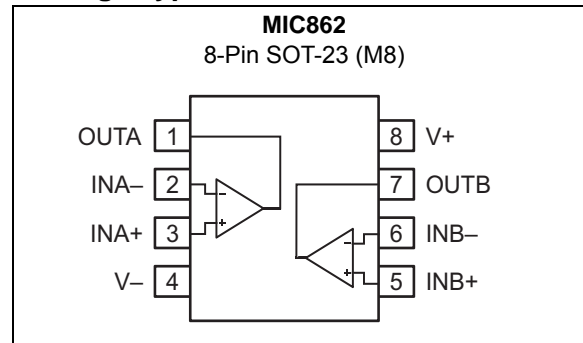

MIC862

Typical Application Schematic

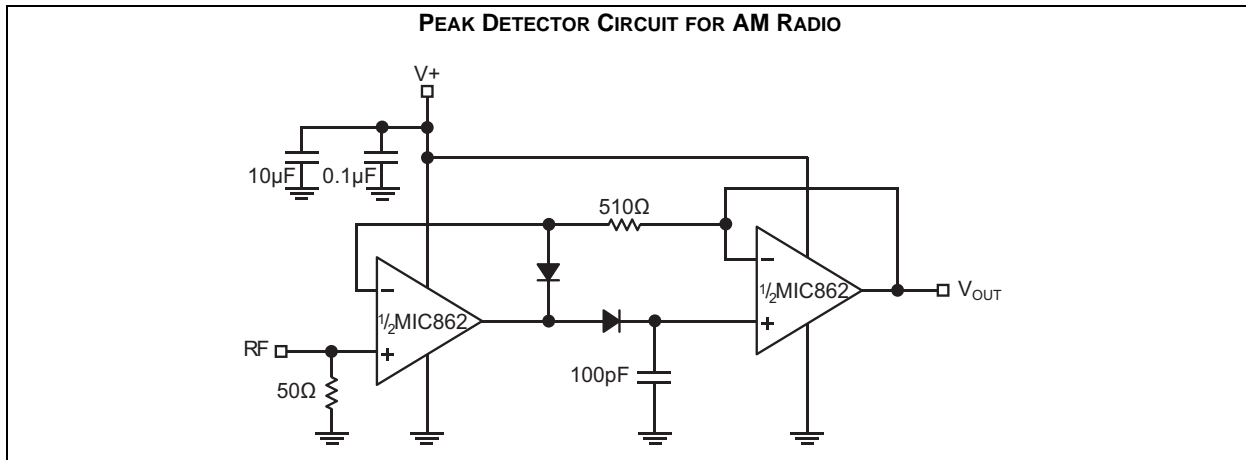

1.0 ELECTRICAL CHARACTERISTICS

Absolute Maximum Ratings †

Supply Voltage (V_{V+} to V_{V-}).....	+6.0V
Differential Input Voltage (V_{IN+} to V_{IN-}) (Note 1).....	+6.0V
Input Voltage (V_{IN+} to V_{IN-}).....	$V_{V+} + 0.3V$, $V_{V-} - 0.3V$
Output Short-Circuit Current Duration.....	Indefinite
ESD Rating (Note 2).....	ESD Sensitive

Operating Ratings ‡

Supply Voltage ($V+$ to $V-$).....	+2.0V to +5.25V
--------------------------------------	-----------------

† **Notice:** Stresses above those listed under “Absolute Maximum Ratings” may cause permanent damage to the device. This is a stress rating only and functional operation of the device at those or any other conditions above those indicated in the operational sections of this specification is not intended. Exposure to maximum rating conditions for extended periods may affect device reliability.

‡ **Notice:** The device is not guaranteed to function outside the operating ratings.

Note 1: Exceeding the maximum differential input voltage will damage the input stage and degrade performance (in particular, input bias current is likely to increase).

2: Devices are ESD sensitive. Handling precautions are recommended. Human body model, 1.5 k Ω in series with 100 pF.

MIC862

TABLE 1-1: ELECTRICAL CHARACTERISTICS

Electrical Characteristics: $V_+ = +2V$, $V_- = 0V$, $V_{CM} = V_+/2$; $R_L = 500\text{ k}\Omega$ to $V_+/2$; $-40^\circ\text{C} \leq T_A \leq +85^\circ\text{C}$ unless otherwise noted.						
Parameters	Symbol	Min.	Typ.	Max.	Units	Conditions
Input Offset Voltage	V_{OS}	-6	0.1	6	mV	—
		-5	0.1	5		$T_A = +25^\circ\text{C}$
		—	0.5	—	mV	—
Differential Offset Voltage	V_{OS}	—	0.5	—	mV	—
Input Offset Voltage Temperature Coefficient		—	6	—	$\mu\text{V}/^\circ\text{C}$	—
Input Bias Current	I_B	—	10	—	pA	—
Input Offset Current	I_{OS}	—	5	—	pA	—
Input Voltage Range (from V_-)	V_{CM}	0.5	1	—	V	CMRR > 50 dB
Common-Mode Rejection Ratio	CMRR	45	75	—	dB	$0V < V_{CM} < 1V$
Power Supply Rejection Ratio	PSRR	50	78	—	dB	Supply voltage change of 2V to 2.7V.
Large-Signal Voltage Gain	A_{VOL}	66	74	—	dB	$R_L = 5\text{ k}\Omega$, $V_{OUT} = 1.4\text{ V}_{PP}$
		75	89	—		$R_L = 100\text{ k}\Omega$, $V_{OUT} = 1.4\text{ V}_{PP}$
		85	100	—		$R_L = 500\text{ k}\Omega$, $V_{OUT} = 1.4\text{ V}_{PP}$
Maximum Output Voltage Swing	V_{OUT}	$V_+ - 80\text{ mV}$	$V_+ - 55\text{ mV}$	—	V	$R_L = 5\text{ k}\Omega$
		$V_+ - 3\text{ mV}$	$V_+ - 1.4\text{ mV}$	—	V	$R_L = 500\text{ k}\Omega$
Minimum Output Voltage Swing	V_{OUT}	—	$V_- + 14\text{ mV}$	$V_- + 20\text{ mV}$	V	$R_L = 5\text{ k}\Omega$
		—	$V_- + 0.85\text{ mV}$	$V_- + 3\text{ mV}$	V	$R_L = 500\text{ k}\Omega$
Gain-Bandwidth Product	GBW	—	2.1	—	MHz	$R_L = 20\text{ k}\Omega$, $C_L = 2\text{ pF}$, $A_V = 11$
Phase Margin	PM	—	57	—	°	$R_L = 20\text{ k}\Omega$, $C_L = 2\text{ pF}$, $A_V = 11$
-3 dB Bandwidth	BW	—	4.2	—	MHz	$R_L = 1\text{ M}\Omega$, $C_L = 2\text{ pF}$, $A_V = 1$
Slew Rate	SR	—	2	—	V/ μs	$R_L = 1\text{ M}\Omega$, $C_L = 2\text{ pF}$, $A_V = 1$, Positive Slew Rate = 1.5 V/ μs
Short-Circuit Output Current	I_{SC}	1.8	2.6	—	mA	Source
		1.5	2.2	—		Sink
Supply Current (per Op Amp)	I_S	—	27	43	μA	No Load
Channel-to-Channel Crosstalk	—	—	-100	—	dB	Note 1

Note 1: DC signal referenced to input. Refer to the [Typical Performance Curves](#) section's AC performance graphs.

TABLE 1-2: ELECTRICAL CHARACTERISTICS

Electrical Characteristics: $V_+ = +2.7V$, $V_- = 0V$, $V_{CM} = V_+/2$; $R_L = 500\text{ k}\Omega$ to $V_+/2$; $-40^\circ\text{C} \leq T_A \leq +85^\circ\text{C}$ unless otherwise noted.

Parameters	Symbol	Min.	Typ.	Max.	Units	Conditions
Input Offset Voltage	V_{OS}	-6	0.1	6	mV	—
		-5	0.1	5		$T_A = +25^\circ\text{C}$
Differential Offset Voltage		—	0.5	—	mV	—
Input Offset Voltage Temperature Coefficient		—	6	—	$\mu\text{V}/^\circ\text{C}$	—
Input Bias Current	I_B	—	10	—	pA	—
Input Offset Current	I_{OS}	—	5	—	pA	—
Input Voltage Range (from V_-)	V_{CM}	1	1.8	—	V	CMRR > 60 dB
Common-Mode Rejection Ratio	CMRR	65	83	—	dB	$0V < V_{CM} < 1.35V$
Power Supply Rejection Ratio	PSRR	60	85	—	dB	Supply voltage change of 2.7V to 3V
Large-Signal Voltage Gain	A_{VOL}	65	77	—	dB	$R_L = 5\text{ k}\Omega$, $V_{OUT} = 2 V_{PP}$
		80	90	—		$R_L = 100\text{ k}\Omega$, $V_{OUT} = 2 V_{PP}$
		90	101	—		$R_L = 500\text{ k}\Omega$, $V_{OUT} = 2 V_{PP}$
Gain-Bandwidth Product	GBW	—	2.3	—	MHz	$R_L = 20\text{ k}\Omega$, $C_L = 2\text{ pF}$, $A_V = 11$
Phase Margin	PM	—	50	—	°	$R_L = 20\text{ k}\Omega$, $C_L = 2\text{ pF}$, $A_V = 11$
-3 dB Bandwidth	BW	—	4.2	—	MHz	$R_L = 1\text{ M}\Omega$, $C_L = 2\text{ pF}$, $A_V = 1$
Slew Rate	SR	—	3	—	V/ μs	$R_L = 1\text{ M}\Omega$, $C_L = 2\text{ pF}$, $A_V = 1$, Positive Slew Rate = 1.5 V/ μs
Short-Circuit Output Current	I_{SC}	4.5	6.3	—	mA	Source
		4.5	6.2	—		Sink
Supply Current (per Op Amp)	I_S	—	28	45	μA	No Load
Channel-to-Channel Crosstalk	—	—	-120	—	dB	Note 1

Note 1: DC signal referenced to input. Refer to the [Typical Performance Curves](#) section's AC performance graphs.

MIC862

TABLE 1-3: ELECTRICAL CHARACTERISTICS

Electrical Characteristics: $V_+ = +5V$, $V_- = 0V$, $V_{CM} = V_+/2$; $R_L = 500\text{ k}\Omega$ to $V_+/2$; $-40^\circ\text{C} \leq T_A \leq +85^\circ\text{C}$ unless otherwise noted.						
Parameters	Symbol	Min.	Typ.	Max.	Units	Conditions
Input Offset Voltage	V_{OS}	-6	0.1	6	mV	—
		-5	0.1	5		$T_A = +25^\circ\text{C}$
Differential Offset Voltage		—	0.5	—	mV	—
Input Offset Voltage Temperature Coefficient		—	6	—	$\mu\text{V}/^\circ\text{C}$	—
Input Bias Current	I_B	—	10	—	pA	—
Input Offset Current	I_{OS}	—	5	—	pA	—
Input Voltage Range (from V_-)	V_{CM}	3.5	4.1	—	V	CMRR > 60 dB
Common-Mode Rejection Ratio	CMRR	60	87	—	dB	$0V < V_{CM} < 3.5V$
Power Supply Rejection Ratio	PSRR	60	92	—	dB	Supply voltage change of 3V to 5V
Large-Signal Voltage Range	A_{VOL}	65	73	—	dB	$R_L = 5\text{ k}\Omega$, $V_{OUT} = 4.8\text{ V}_{PP}$
		80	86	—		$R_L = 100\text{ k}\Omega$, $V_{OUT} = 4.8\text{ V}_{PP}$
		89	96	—		$R_L = 500\text{ k}\Omega$, $V_{OUT} = 4.8\text{ V}_{PP}$
Maximum Output Voltage Swing	V_{OUT}	$V_+ - 50\text{ mV}$	$V_+ - 37\text{ mV}$	—	V	$R_L = 5\text{ k}\Omega$
		$V_+ - 3\text{ mV}$	$V_+ - 1.3\text{ mV}$	—		$R_L = 500\text{ k}\Omega$
—		$V_- + 24\text{ mV}$	$V_- + 40\text{ mV}$	$R_L = 5\text{ k}\Omega$		
—		$V_- + 0.7\text{ mV}$	$V_- + 3\text{ mV}$	$R_L = 500\text{ k}\Omega$		
Minimum Output Voltage Swing						
Gain-Bandwidth Product	GBW	—	3	—	MHz	$R_L = 20\text{ k}\Omega$, $C_L = 2\text{ pF}$, $A_V = 11$
Phase Margin	PM	—	45	—	°	—
-3 dB Bandwidth	BW	—	5	—	MHz	$R_L = 1\text{ M}\Omega$, $C_L = 2\text{ pF}$, $A_V = 1$
Slew Rate	SR	—	4	—	V/ μs	$R_L = 1\text{ M}\Omega$, $C_L = 2\text{ pF}$, $A_V = 1$, Positive Slew Rate = 1.5 V/ μs
Short-Circuit Output Current	I_{SC}	17	23	—	mA	Source
		18	27	—		Sink
Supply Current (per Op Amp)	I_S	—	31	47	μA	No Load
Channel-to-Channel Crosstalk	—	—	-120	—	dB	Note 1

Note 1: DC signal referenced to input. Refer to the [Typical Performance Curves](#) section's AC performance graphs.

TEMPERATURE SPECIFICATIONS (Note 1)

Parameters	Sym.	Min.	Typ.	Max.	Units	Conditions
Temperature Ranges						
Operating Temperature Range	—	-40	—	+125	°C	—
Storage Temperature Range	T _S	—	—	+150	°C	—
Ambient Temperature Range	T _A	-40	—	+85	°C	—
Package Thermal Resistance						
Thermal Resistance SOT-23-8	θ _{JA}	—	100	—	°C/W	Using 4-Layer PCB
	θ _{JC}	—	70	—	°C/W	Using 4-Layer PCB

Note 1: The maximum allowable power dissipation is a function of ambient temperature, the maximum allowable junction temperature and the thermal resistance from junction to air (i.e., T_A, T_J, θ_{JA}). Exceeding the maximum allowable power dissipation will cause the device operating junction temperature to exceed the maximum +125°C rating. Sustained junction temperatures above +125°C can impact the device reliability.

2.0 TYPICAL PERFORMANCE CURVES

Note: The graphs and tables provided following this note are a statistical summary based on a limited number of samples and are provided for informational purposes only. The performance characteristics listed herein are not tested or guaranteed. In some graphs or tables, the data presented may be outside the specified operating range (e.g., outside specified power supply range) and therefore outside the warranted range.

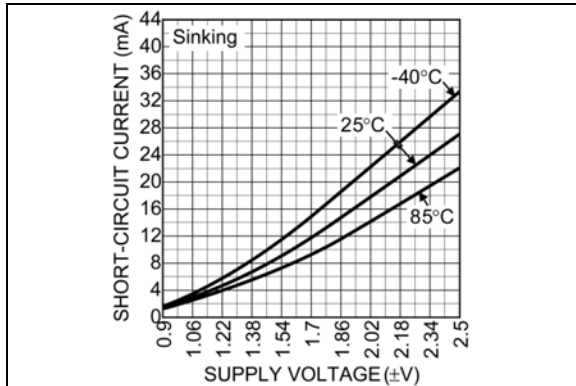

FIGURE 2-1: Short-Circuit Current vs. Supply Voltage.

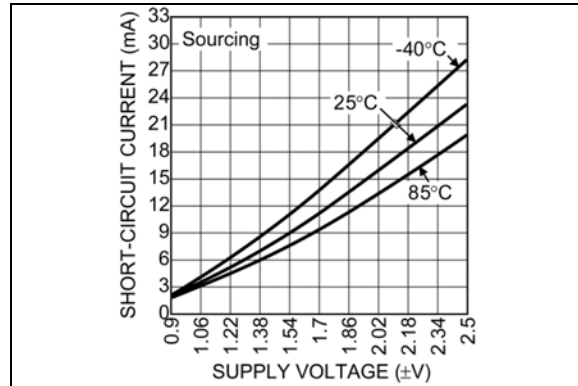

FIGURE 2-4: Short-Circuit Current vs. Supply Voltage.

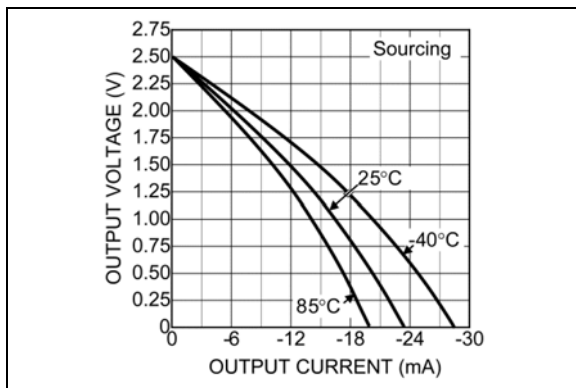

FIGURE 2-2: Output Voltage vs. Output Current.

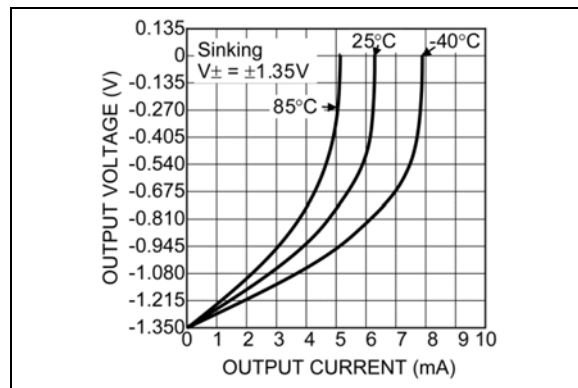

FIGURE 2-5: Output Voltage vs. Output Current.

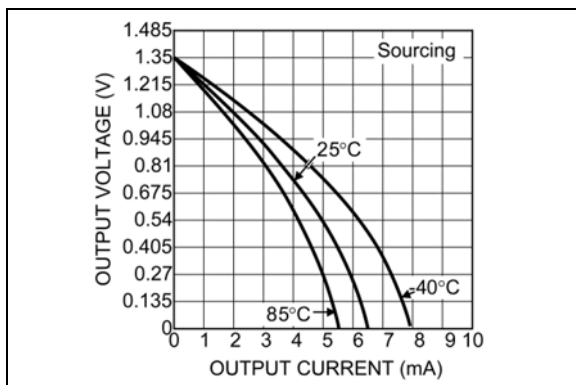

FIGURE 2-3: Output Voltage vs. Output Current.

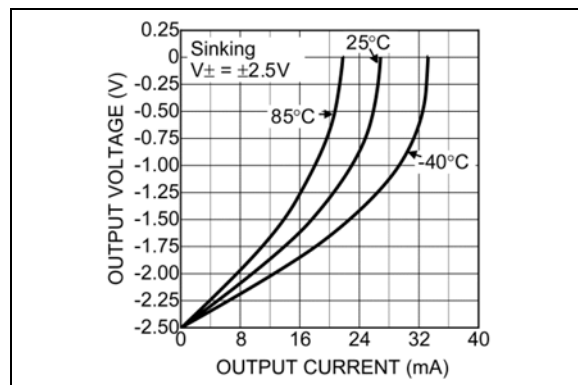

FIGURE 2-6: Output Voltage vs. Output Current.

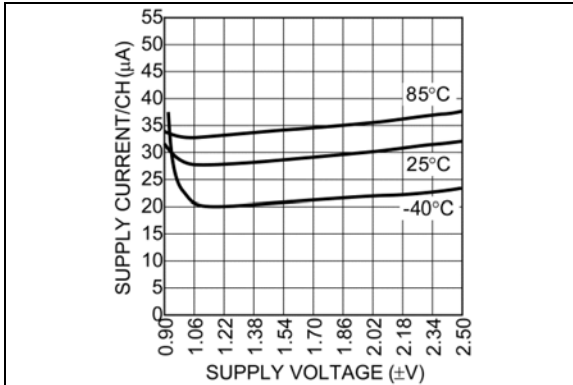

FIGURE 2-7: Supply Current vs. Supply Voltage.

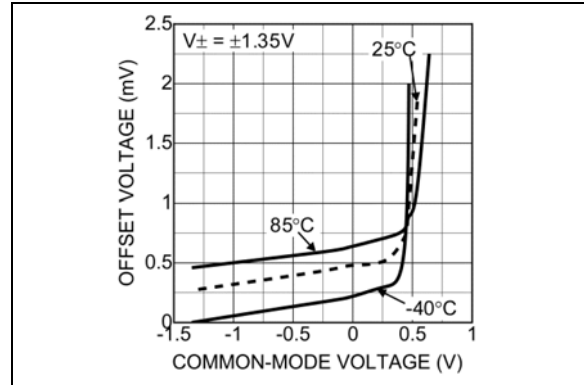

FIGURE 2-10: Offset Voltage vs. Common-Mode Voltage.

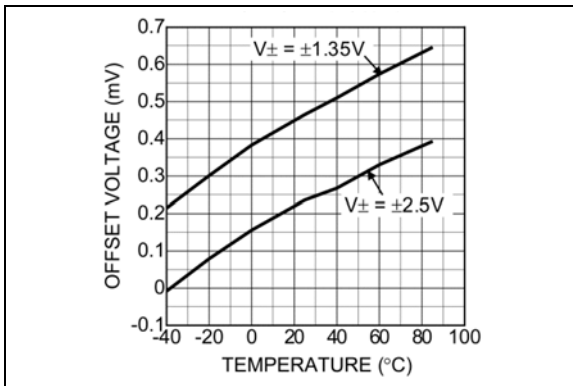

FIGURE 2-8: Offset Voltage vs. Temperature.

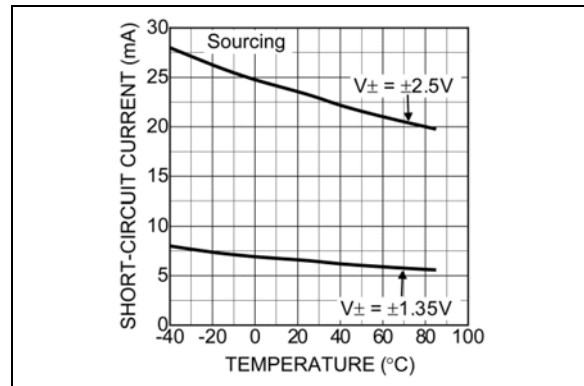

FIGURE 2-11: Short-Circuit Current vs. Temperature.

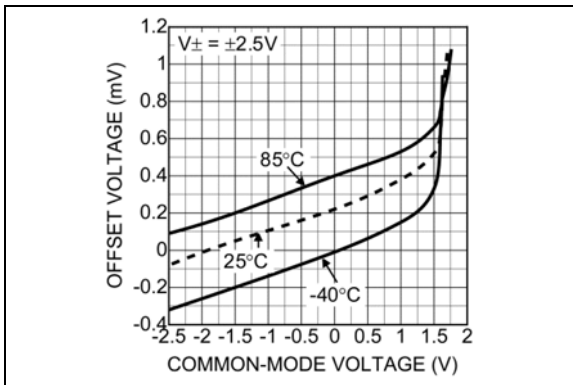

FIGURE 2-9: Offset Voltage vs. Common-Mode Voltage.

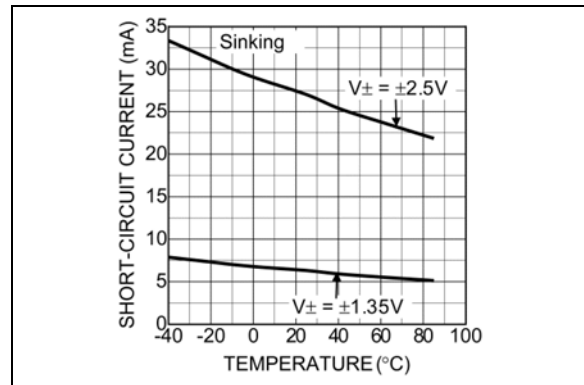

FIGURE 2-12: Short-Circuit Current vs. Temperature.

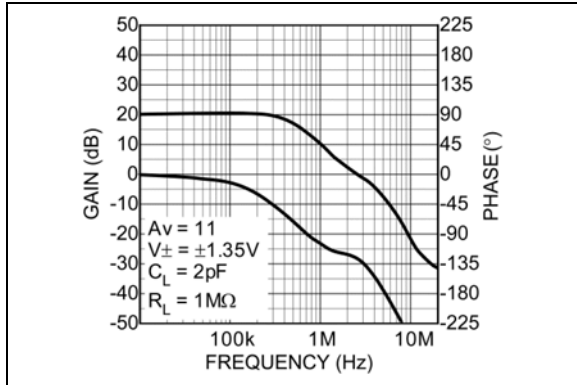

FIGURE 2-13: Gain Bandwidth and Phase Margin.

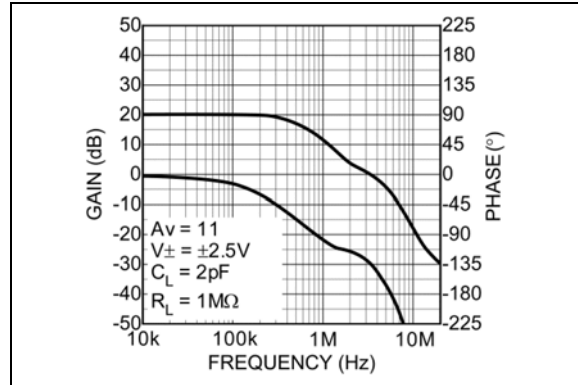

FIGURE 2-16: Gain Bandwidth and Phase Margin.

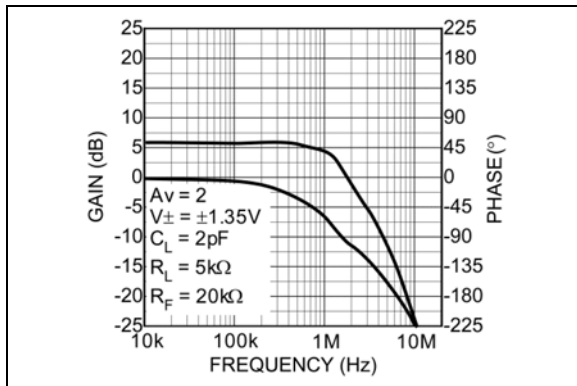

FIGURE 2-14: Gain Frequency Response.

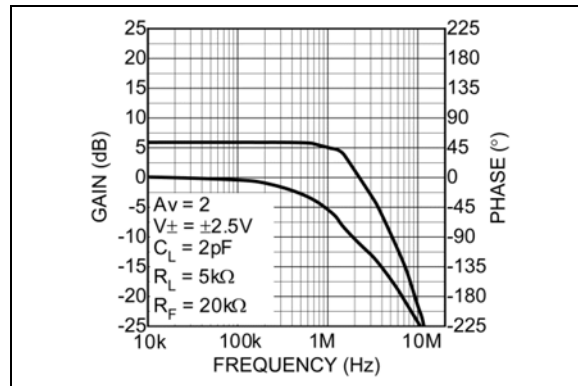

FIGURE 2-17: Gain Frequency Response.

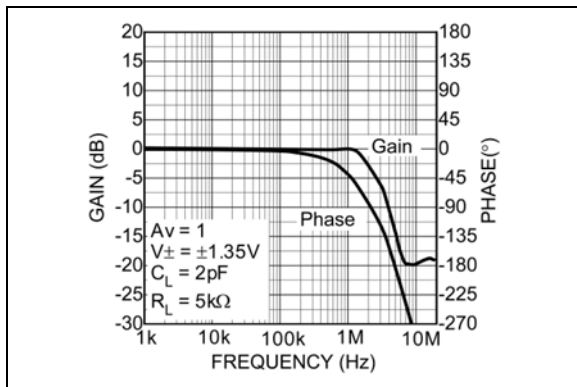

FIGURE 2-15: Unity Gain Frequency Response.

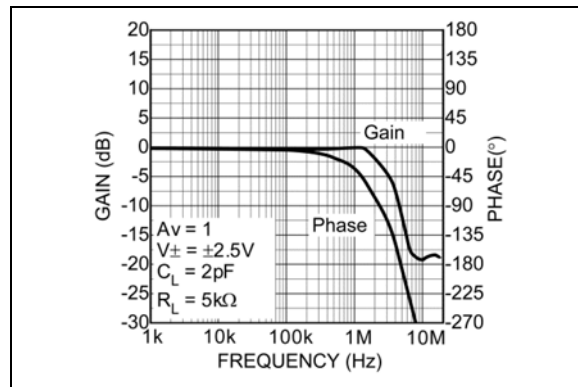

FIGURE 2-18: Unity Gain Frequency Response.

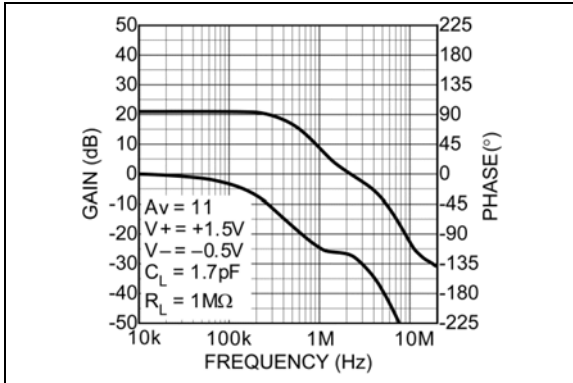

FIGURE 2-19: Gain Bandwidth and Phase Margin.

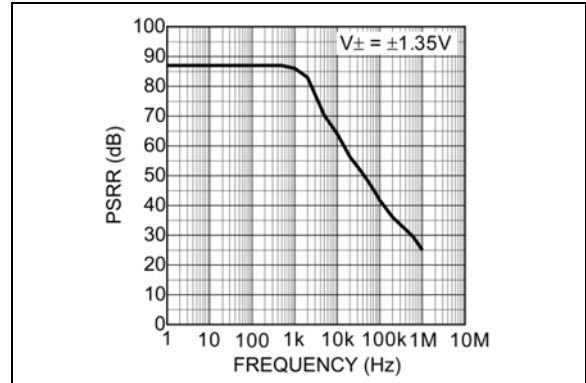

FIGURE 2-22: PSRR vs. Frequency.

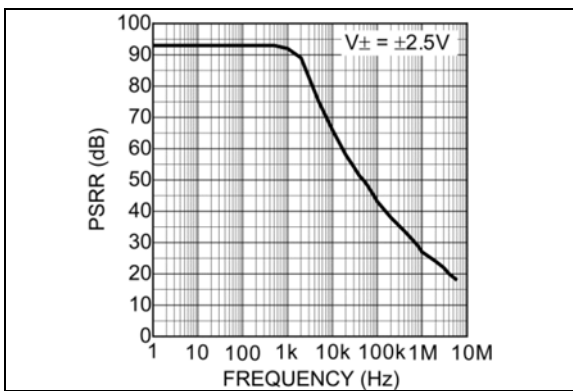

FIGURE 2-20: PSRR vs. Frequency.

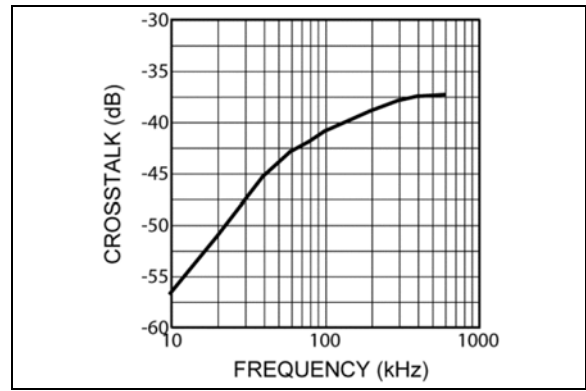

FIGURE 2-23: Channel-to-Channel Crosstalk.

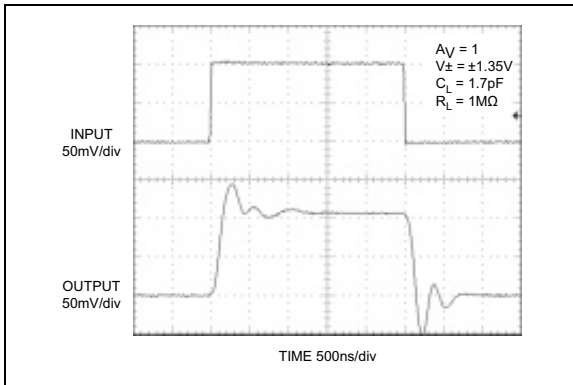

FIGURE 2-21: Small Signal Response.

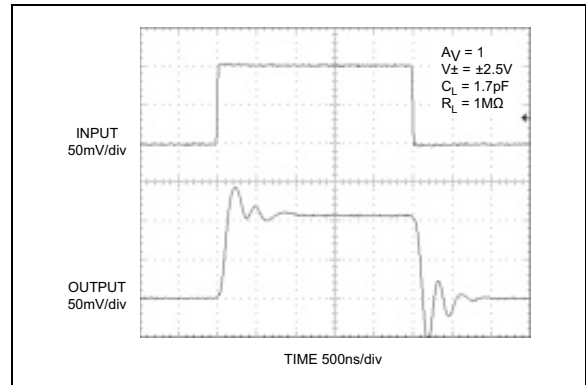

FIGURE 2-24: Small Signal Response.

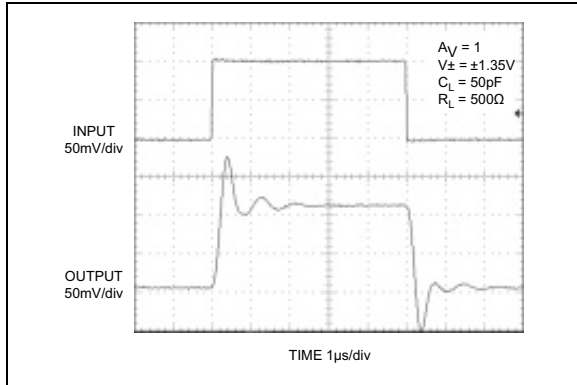

FIGURE 2-25: Small Signal Response.

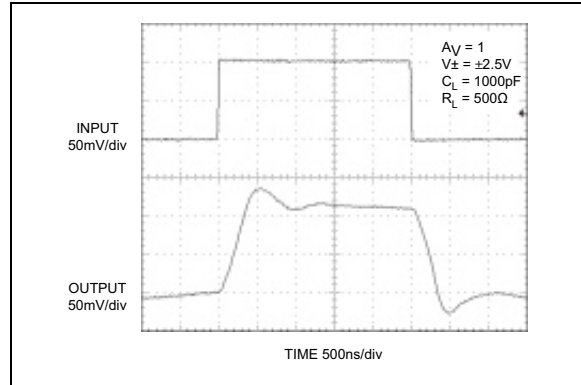

FIGURE 2-28: Small Signal Response.

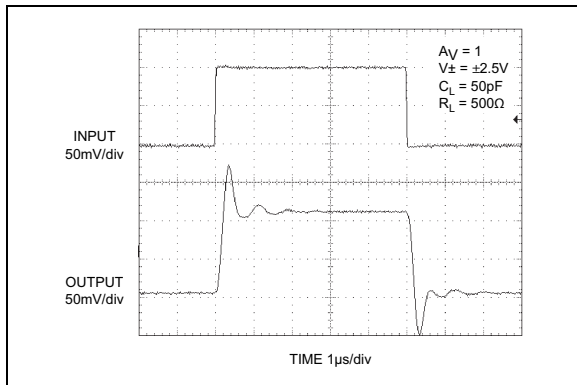

FIGURE 2-26: Small Signal Response.

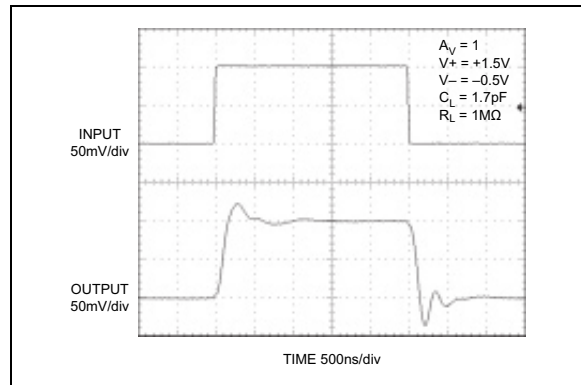

FIGURE 2-29: Small Signal Pulse Response.

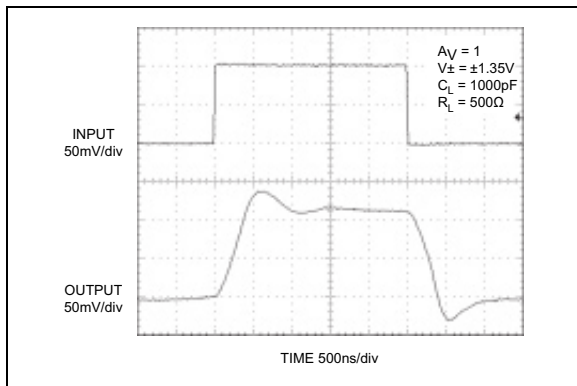

FIGURE 2-27: Small Signal Response.

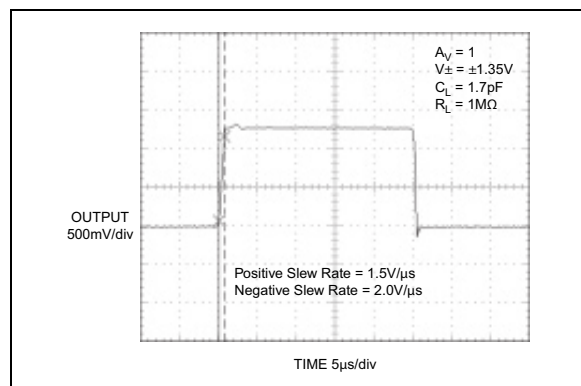

FIGURE 2-30: Large Signal Response.

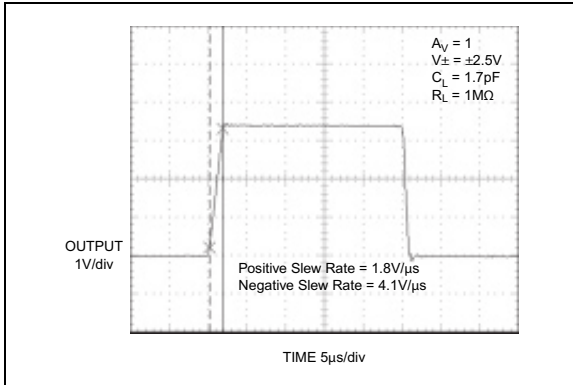

FIGURE 2-31: Large Signal Response.

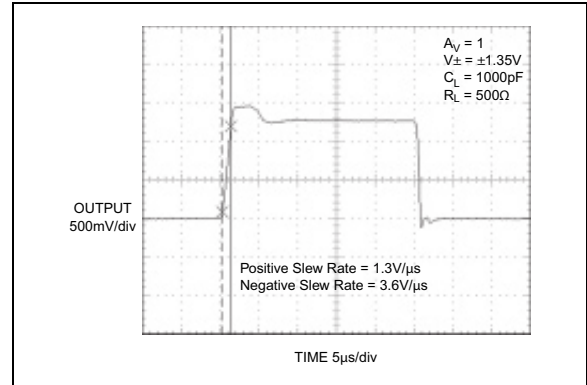

FIGURE 2-34: Large Signal Pulse Response.

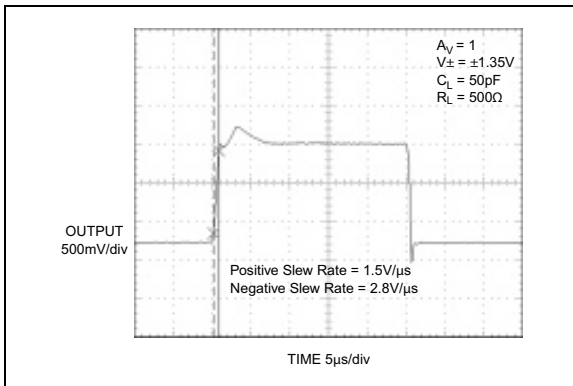

FIGURE 2-32: Large Signal Response.

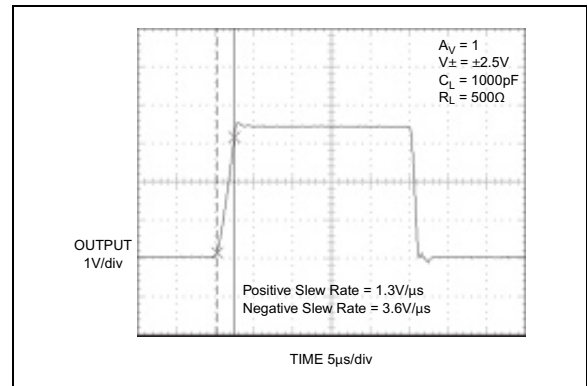

FIGURE 2-35: Large Signal Pulse Response.

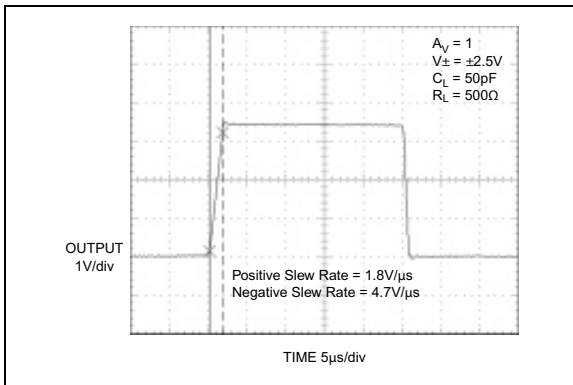

FIGURE 2-33: Large Signal Response.

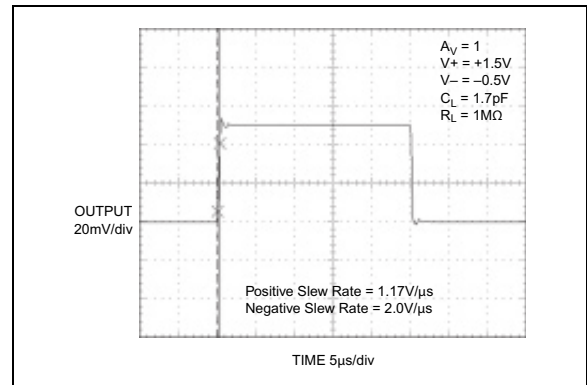

FIGURE 2-36: Large Signal Pulse Response.

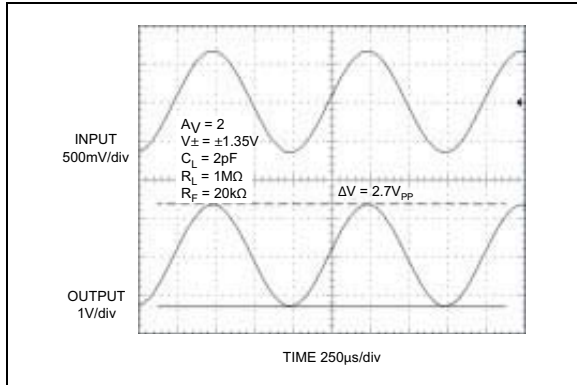

FIGURE 2-37: Rail-to-Rail Operation.

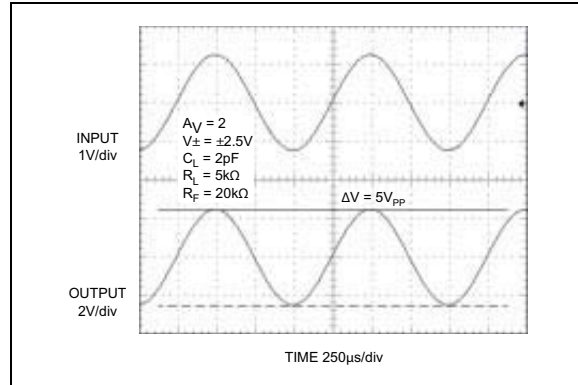

FIGURE 2-40: Rail-to-Rail Operation.

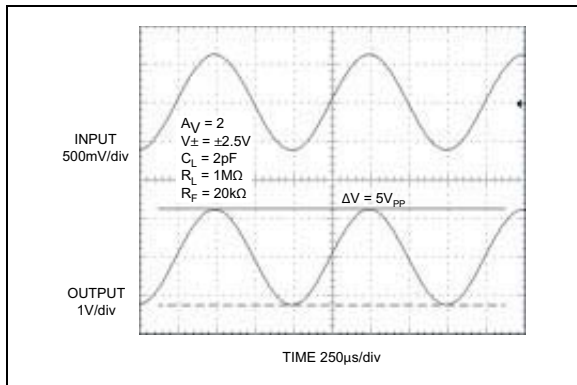

FIGURE 2-38: Rail-to-Rail Operation.

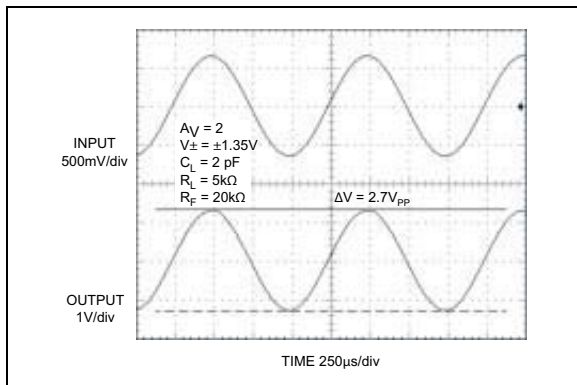

FIGURE 2-39: Rail-to-Rail Operation.

3.0 PIN DESCRIPTIONS

The descriptions of the pins are listed in [Table 3-1](#).

TABLE 3-1: PIN FUNCTION TABLE

Pin Number	Symbol	Description
1	OUTA	Amplifier A Output.
2	INA-	Amplifier A Inverting Input.
3	INA+	Amplifier A Non-Inverting Input
4	V-	Negative Supply.
5	INB+	Amplifier B Non-Inverting Input.
6	INB-	Amplifier B Inverting Input.
7	OUTB	Amplifier B Output.
8	V+	Positive Supply.

4.0 APPLICATION INFORMATION

4.1 Power Supply Bypassing

Regular supply bypassing techniques are recommended. A 10 μF capacitor in parallel with a 0.1 μF capacitor on both the positive and negative supplies are ideal. For best performance all bypassing capacitors should be located as close to the op amp as possible and all capacitors should be low ESL (equivalent series inductance), ESR (equivalent series resistance). Surface-mount ceramic capacitors are ideal.

4.2 Supply and Loading Resistive Considerations

The MIC862 is intended for single-supply applications configured with a grounded load. It is not advisable to operate the MIC862 under either of the following conditions:

- A grounded load and split supplies ($\pm\text{V}$)
- A single supply where the load is terminated above ground.

Under the above conditions, if the load is less than 20 $\text{k}\Omega$ and the output swing is greater than 1V (peak), there may be some instability when the output is sinking current.

4.3 Capacitive Load

When driving a large capacitive load, a resistor of 500 Ω is recommended to be connected between the op amp output and the capacitive load to avoid oscillation.

5.0 PACKAGING INFORMATION

5.1 Package Marking Information

8-Pin SOT-23*

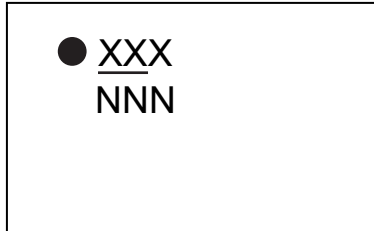

Example

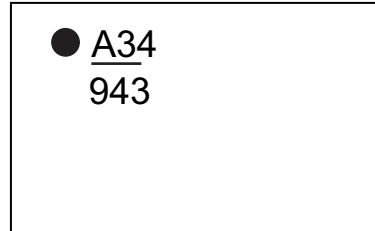

Legend:	XX...X	Product code or customer-specific information
	Y	Year code (last digit of calendar year)
	YY	Year code (last 2 digits of calendar year)
	WW	Week code (week of January 1 is week '01')
	NNN	Alphanumeric traceability code
	(e3)	Pb-free JEDEC® designator for Matte Tin (Sn)
	*	This package is Pb-free. The Pb-free JEDEC designator (e3) can be found on the outer packaging for this package.
	•, ▲, ▼	Pin one index is identified by a dot, delta up, or delta down (triangle mark).
Note:	In the event the full Microchip part number cannot be marked on one line, it will be carried over to the next line, thus limiting the number of available characters for customer-specific information. Package may or may not include the corporate logo.	
	Underbar (̄) and/or Overbar (¯) symbol may not be to scale.	

MIC862

8-Lead SOT-23 Package Outline and Recommended Land Pattern

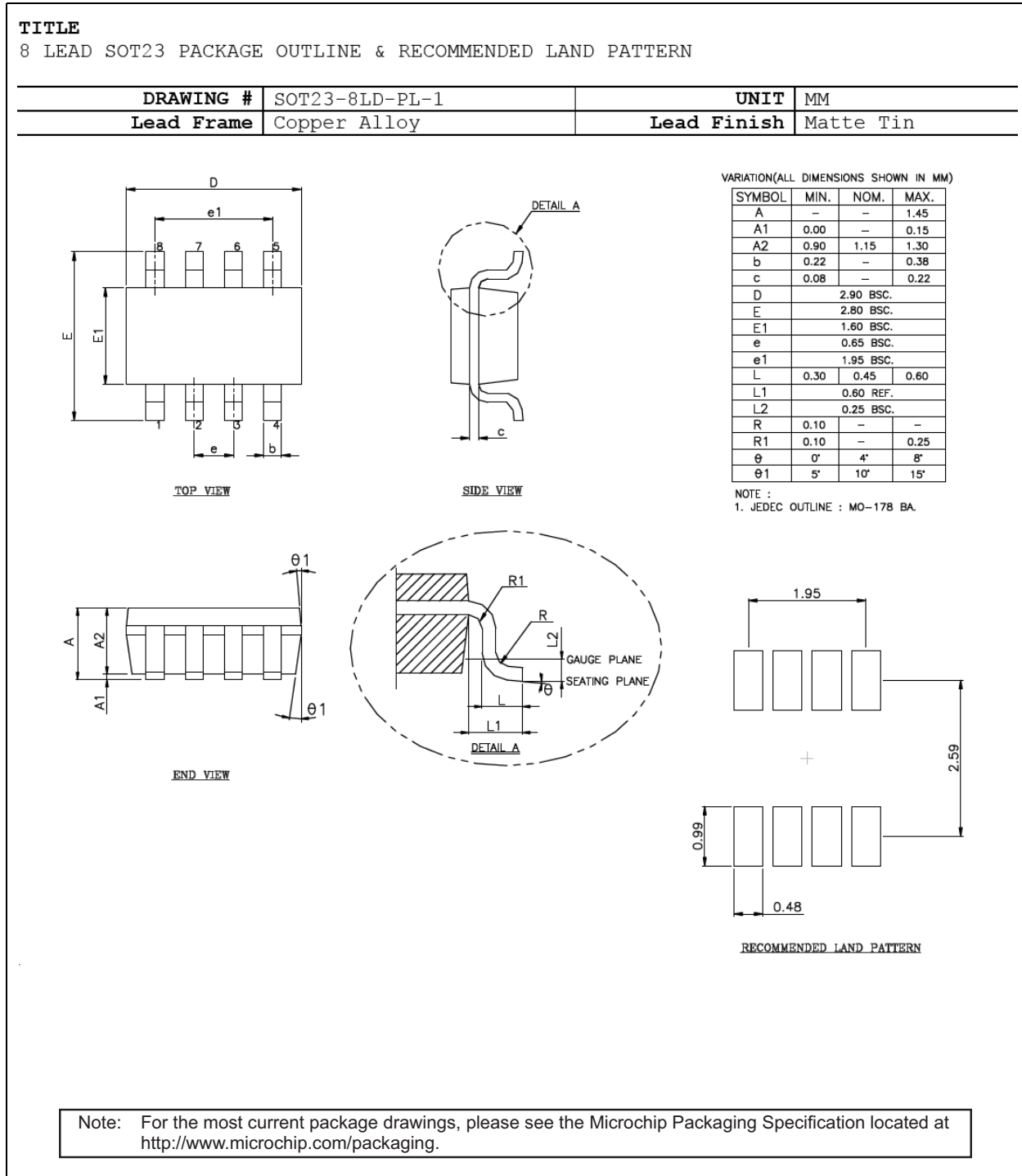

Note: For the most current package drawings, please see the Microchip Packaging Specification located at <http://www.microchip.com/packaging>.

APPENDIX A: REVISION HISTORY

Revision A (August 2017)

- Converted Micrel document MIC862 to Microchip data sheet template DS20005836A.
- Minor text changes throughout.
- Corrected the [Product Identification System](#) section by removing an erroneous letter T from the part number.

MIC862

NOTES:

PRODUCT IDENTIFICATION SYSTEM

To order or obtain information, e.g., on pricing or delivery, contact your local Microchip representative or sales office.

<u>PART NO.</u>		X	XX	-XX
Device	Temperature	Package	Media Type	
Device:	MIC862:	Dual Ultra-Low Power Op Amp		
Temperature:	Y =	-40°C to +85°C		
Package:	M8 =	8-Lead SOT-23		
Media Type:	TR =	3,000/Reel		

Examples:

a) MIC862YM8-TR: Dual Ultra-Low Power Op Amp, -40°C to +85°C Junction Temperature Range, 8-Lead SOT-23 Package, 3,000/Reel

Note 1: Tape and Reel identifier only appears in the catalog part number description. This identifier is used for ordering purposes and is not printed on the device package. Check with your Microchip Sales Office for package availability with the Tape and Reel option.

MIC862

NOTES:

Note the following details of the code protection feature on Microchip devices:

- Microchip products meet the specification contained in their particular Microchip Data Sheet.
- Microchip believes that its family of products is one of the most secure families of its kind on the market today, when used in the intended manner and under normal conditions.
- There are dishonest and possibly illegal methods used to breach the code protection feature. All of these methods, to our knowledge, require using the Microchip products in a manner outside the operating specifications contained in Microchip's Data Sheets. Most likely, the person doing so is engaged in theft of intellectual property.
- Microchip is willing to work with the customer who is concerned about the integrity of their code.
- Neither Microchip nor any other semiconductor manufacturer can guarantee the security of their code. Code protection does not mean that we are guaranteeing the product as “unbreakable.”

Code protection is constantly evolving. We at Microchip are committed to continuously improving the code protection features of our products. Attempts to break Microchip's code protection feature may be a violation of the Digital Millennium Copyright Act. If such acts allow unauthorized access to your software or other copyrighted work, you may have a right to sue for relief under that Act.

Information contained in this publication regarding device applications and the like is provided only for your convenience and may be superseded by updates. It is your responsibility to ensure that your application meets with your specifications. MICROCHIP MAKES NO REPRESENTATIONS OR WARRANTIES OF ANY KIND WHETHER EXPRESS OR IMPLIED, WRITTEN OR ORAL, STATUTORY OR OTHERWISE, RELATED TO THE INFORMATION, INCLUDING BUT NOT LIMITED TO ITS CONDITION, QUALITY, PERFORMANCE, MERCHANTABILITY OR FITNESS FOR PURPOSE. Microchip disclaims all liability arising from this information and its use. Use of Microchip devices in life support and/or safety applications is entirely at the buyer's risk, and the buyer agrees to defend, indemnify and hold harmless Microchip from any and all damages, claims, suits, or expenses resulting from such use. No licenses are conveyed, implicitly or otherwise, under any Microchip intellectual property rights unless otherwise stated.

Microchip received ISO/TS-16949:2009 certification for its worldwide headquarters, design and wafer fabrication facilities in Chandler and Tempe, Arizona; Gresham, Oregon and design centers in California and India. The Company's quality system processes and procedures are for its PIC® MCUs and dsPIC® DSCs, KEELoC® code hopping devices, Serial EEPROMs, microperipherals, nonvolatile memory and analog products. In addition, Microchip's quality system for the design and manufacture of development systems is ISO 9001:2000 certified.

**QUALITY MANAGEMENT SYSTEM
CERTIFIED BY DNV
= ISO/TS 16949 =**

Trademarks

The Microchip name and logo, the Microchip logo, AnyRate, AVR, AVR logo, AVR Freaks, BeaconThings, BitCloud, CryptoMemory, CryptoRF, dsPIC, FlashFlex, flexPWR, Helder, JukeBlox, KEELoC, KEELoC logo, Klear, LANCheck, LINK MD, maXStylus, maXTouch, MediaLB, megaAVR, MOST, MOST logo, MPLAB, OptoLyzer, PIC, picoPower, PICSTART, PIC32 logo, Prochip Designer, QTouch, RightTouch, SAM-BA, SpyNIC, SST, SST Logo, SuperFlash, tinyAVR, UNI/O, and XMEGA are registered trademarks of Microchip Technology Incorporated in the U.S.A. and other countries.

ClockWorks, The Embedded Control Solutions Company, EtherSynch, Hyper Speed Control, HyperLight Load, IntelliMOS, mTouch, Precision Edge, and Quiet-Wire are registered trademarks of Microchip Technology Incorporated in the U.S.A.

Adjacent Key Suppression, AKS, Analog-for-the-Digital Age, Any Capacitor, AnyIn, AnyOut, BodyCom, chipKIT, chipKIT logo, CodeGuard, CryptoAuthentication, CryptoCompanion, CryptoController, dsPICDEM, dsPICDEM.net, Dynamic Average Matching, DAM, ECAN, EtherGREEN, In-Circuit Serial Programming, ICSP, Inter-Chip Connectivity, JitterBlocker, KlearNet, KlearNet logo, Mindi, MiWi, motorBench, MPASM, MPF, MPLAB Certified logo, MPLIB, MPLINK, MultiTRAK, NetDetach, Omniscient Code Generation, PICDEM, PICDEM.net, PICKit, PICTail, PureSilicon, QMatrix, RightTouch logo, REAL ICE, Ripple Blocker, SAM-ICE, Serial Quad I/O, SMART-I.S., SQI, SuperSwitcher, SuperSwitcher II, Total Endurance, TSHARC, USBCheck, VariSense, ViewSpan, WiperLock, Wireless DNA, and ZENA are trademarks of Microchip Technology Incorporated in the U.S.A. and other countries.

SQTP is a service mark of Microchip Technology Incorporated in the U.S.A.

Silicon Storage Technology is a registered trademark of Microchip Technology Inc. in other countries.

GestIC is a registered trademark of Microchip Technology Germany II GmbH & Co. KG, a subsidiary of Microchip Technology Inc., in other countries.

All other trademarks mentioned herein are property of their respective companies.

© 2017, Microchip Technology Incorporated, All Rights Reserved.
ISBN: 978-1-5224-2084-2



MICROCHIP

Worldwide Sales and Service

AMERICAS

Corporate Office
2355 West Chandler Blvd.
Chandler, AZ 85224-6199
Tel: 480-792-7200
Fax: 480-792-7277
Technical Support:
<http://www.microchip.com/support>
Web Address:
www.microchip.com

Atlanta
Duluth, GA
Tel: 678-957-9614
Fax: 678-957-1455

Austin, TX
Tel: 512-257-3370

Boston
Westborough, MA
Tel: 774-760-0087
Fax: 774-760-0088

Chicago
Itasca, IL
Tel: 630-285-0071
Fax: 630-285-0075

Dallas
Addison, TX
Tel: 972-818-7423
Fax: 972-818-2924

Detroit
Novi, MI
Tel: 248-848-4000

Houston, TX
Tel: 281-894-5983

Indianapolis
Noblesville, IN
Tel: 317-773-8323
Fax: 317-773-5453
Tel: 317-536-2380

Los Angeles
Mission Viejo, CA
Tel: 949-462-9523
Fax: 949-462-9608
Tel: 951-273-7800

Raleigh, NC
Tel: 919-844-7510

New York, NY
Tel: 631-435-6000

San Jose, CA
Tel: 408-735-9110
Tel: 408-436-4270

Canada - Toronto
Tel: 905-695-1980
Fax: 905-695-2078

ASIA/PACIFIC

Asia Pacific Office
Suites 3707-14, 37th Floor
Tower 6, The Gateway
Harbour City, Kowloon

Hong Kong
Tel: 852-2943-5100
Fax: 852-2401-3431

Australia - Sydney
Tel: 61-2-9868-6733
Fax: 61-2-9868-6755

China - Beijing
Tel: 86-10-8569-7000
Fax: 86-10-8528-2104

China - Chengdu
Tel: 86-28-8665-5511
Fax: 86-28-8665-7889

China - Chongqing
Tel: 86-23-8980-9588
Fax: 86-23-8980-9500

China - Dongguan
Tel: 86-769-8702-9880

China - Guangzhou
Tel: 86-20-8755-8029

China - Hangzhou
Tel: 86-571-8792-8115
Fax: 86-571-8792-8116

China - Hong Kong SAR
Tel: 852-2943-5100
Fax: 852-2401-3431

China - Nanjing
Tel: 86-25-8473-2460
Fax: 86-25-8473-2470

China - Qingdao
Tel: 86-532-8502-7355
Fax: 86-532-8502-7205

China - Shanghai
Tel: 86-21-3326-8000
Fax: 86-21-3326-8021

China - Shenyang
Tel: 86-24-2334-2829
Fax: 86-24-2334-2393

China - Shenzhen
Tel: 86-755-8864-2200
Fax: 86-755-8203-1760

China - Wuhan
Tel: 86-27-5980-5300
Fax: 86-27-5980-5118

China - Xian
Tel: 86-29-8833-7252
Fax: 86-29-8833-7256

ASIA/PACIFIC

China - Xiamen
Tel: 86-592-2388138
Fax: 86-592-2388130

China - Zhuhai
Tel: 86-756-3210040
Fax: 86-756-3210049

India - Bangalore
Tel: 91-80-3090-4444
Fax: 91-80-3090-4123

India - New Delhi
Tel: 91-11-4160-8631
Fax: 91-11-4160-8632

India - Pune
Tel: 91-20-3019-1500

Japan - Osaka
Tel: 81-6-6152-7160
Fax: 81-6-6152-9310

Japan - Tokyo
Tel: 81-3-6880-3770
Fax: 81-3-6880-3771

Korea - Daegu
Tel: 82-53-744-4301
Fax: 82-53-744-4302

Korea - Seoul
Tel: 82-2-554-7200
Fax: 82-2-558-5932 or
82-2-558-5934

Malaysia - Kuala Lumpur
Tel: 60-3-6201-9857
Fax: 60-3-6201-9859

Malaysia - Penang
Tel: 60-4-227-8870
Fax: 60-4-227-4068

Philippines - Manila
Tel: 63-2-634-9065
Fax: 63-2-634-9069

Singapore
Tel: 65-6334-8870
Fax: 65-6334-8850

Taiwan - Hsin Chu
Tel: 886-3-5778-366
Fax: 886-3-5770-955

Taiwan - Kaohsiung
Tel: 886-7-213-7830

Taiwan - Taipei
Tel: 886-2-2508-8600
Fax: 886-2-2508-0102

Thailand - Bangkok
Tel: 66-2-694-1351
Fax: 66-2-694-1350

EUROPE

Austria - Wels
Tel: 43-7242-2244-39
Fax: 43-7242-2244-393

Denmark - Copenhagen
Tel: 45-4450-2828
Fax: 45-4485-2829

Finland - Espoo
Tel: 358-9-4520-820

France - Paris
Tel: 33-1-69-53-63-20
Fax: 33-1-69-30-90-79

France - Saint Cloud
Tel: 33-1-30-60-70-00

Germany - Garching
Tel: 49-8931-9700

Germany - Haan
Tel: 49-2129-3766400

Germany - Heilbronn
Tel: 49-7131-67-3636

Germany - Karlsruhe
Tel: 49-721-625370

Germany - Munich
Tel: 49-89-627-144-0
Fax: 49-89-627-144-44

Germany - Rosenheim
Tel: 49-8031-354-560

Israel - Ra'anana
Tel: 972-9-744-7705

Italy - Milan
Tel: 39-0331-742611
Fax: 39-0331-466781

Italy - Padova
Tel: 39-049-7625286

Netherlands - Drunen
Tel: 31-416-690399
Fax: 31-416-690340

Norway - Trondheim
Tel: 47-7289-7561

Poland - Warsaw
Tel: 48-22-3325737

Romania - Bucharest
Tel: 40-21-407-87-50

Spain - Madrid
Tel: 34-91-708-08-90
Fax: 34-91-708-08-91

Sweden - Gothenberg
Tel: 46-31-704-60-40

Sweden - Stockholm
Tel: 46-8-5090-4654

UK - Wokingham
Tel: 44-118-921-5800
Fax: 44-118-921-5820