



MIC5304

Single 150mA Low Operating Current
LDO with Dual Voltage Pin Select

General Description

The MIC5304 is a low quiescent current, low dropout regulator with selectable output voltage designed for applications that require two levels of output voltage regulation. The MIC5304 is an ideal solution for programming memory cards as well as for conserving power in portable applications. The MIC5304 is capable of sourcing 150mA of output current while only consuming 24 μ A of operating current. This high performance LDO offers fast transient response while still maintaining low quiescent current levels.

The MIC5304 is an ideal solution for battery operated applications due to ultra low operating current and extremely low dropout voltage of 85mV at 150mA. Equipped with a TTL logic compatible enable pin, the MIC5304 can be put into a zero-off mode current state, drawing virtually no current when disabled.

Board space and component cost is minimized because the MIC5304 operates with very small 1 μ F ceramic capacitors. The MIC5304 provides fixed output voltages, and is available in the tiny 1.6mm x 1.6mm Thin MLF[®] package ideal for portable electronics.

MIC5304 also features thermal shutdown and current limit protection.

Data sheets and support documentation can be found on Micrel's web site at: www.micrel.com.

Features

- 150mA output current
- Logic controlled selectable output voltage
- Fast transition time between selected output voltages
- Input voltage range: 2.3V to 5.5V
- Low 24 μ A operating current
- Stable with 1 μ F ceramic capacitors
- Low dropout voltage of 85mV @ 150mA
- Thermal shutdown and current limit protection
- Tiny 6-pin 1.6mm x 1.6mm Thin MLF[®] package

Applications

- Mobile phones, PDAs, PMPs, PNDs
- Digital still and video cameras
- Dual voltage levels for power saving mode
- Portable electronics

Typical Application

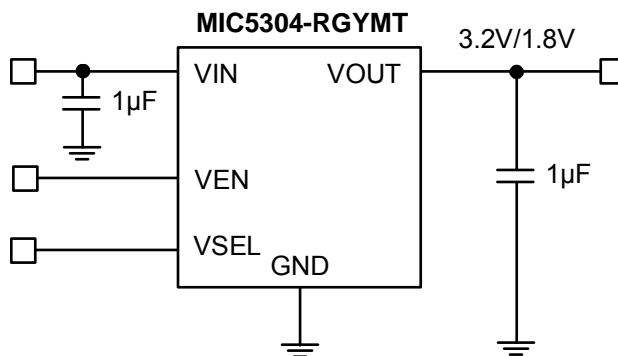

Selectable Output Voltage LDO Application

MLF and *MicroLeadFrame* are registered trademarks of Amkor Technology, Inc.

Micrel Inc. • 2180 Fortune Drive • San Jose, CA 95131 • USA • tel +1 (408) 944-0800 • fax + 1 (408) 474-1000 • <http://www.micrel.com>

Ordering Information

Part Number	Marking ⁽¹⁾	Voltage ⁽²⁾ V _{SEL=High}	Voltage ⁽²⁾ V _{SEL=Low}	Temperature Range	Package ⁽³⁾
MIC5304-RGYMT	RQZ	3.2V	1.8V	-40° to +125°C	6-Pin 1.6mm x1.6mm Thin MLF [®]
MIC5304-XDYMT	XQD	3.15V	1.85V	-40° to +125°C	6-Pin 1.6mm x1.6mm Thin MLF [®]
MIC5304-XGHYMT	XGH	3.15V	1.875V	-40° to +125°C	6-Pin 1.6mm x1.6mm Thin MLF [®]

Note:

1. Pin 1 identifier = ▲
2. For other voltage options contact Micrel Marketing for details.
3. MLF is GREEN RoHs compliant package. Lead finish is NiPdAu, Hold compound is Hydrogen Free.

Pin Configuration

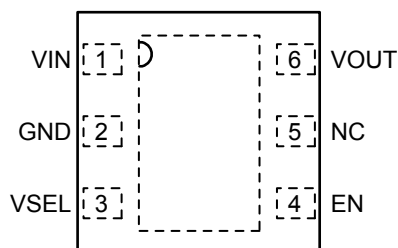

6-Pin 1.6mm x 1.6mm Thin MLF[®] (MT)

Pin Description

Pin Number	Pin Name	Pin Function
1	VIN	Supply Input.
2	GND	Ground.
3	VSEL	Voltage Select Input. Logic high = higher output voltage; Logic low = lower output voltage. Do not leave floating.
4	EN	Enable Input: Active High Input. Logic High = On; Logic Low = Off. Do not leave floating.
5	NC	Not internally connected.
6	VOUT	Output Voltage.
HS Pad	E PAD	Exposed heatsink pad connected to ground internally.

Absolute Maximum Ratings⁽¹⁾

Supply Voltage (V_{IN})	-0.3V to +6V
Enable/Select Voltage (V_{EN}/V_{SEL})	-0.3V to V_{IN}
Power Dissipation (P_D)	Internally Limited ⁽³⁾
Lead Temperature (soldering, 5sec.)	260°C
Junction Temperature (T_J)	-40°C to +125°C
Storage Temperature (T_s)	-65°C to +150°C
ESD Rating ⁽⁴⁾	2kV

Operating Ratings⁽²⁾

Supply Voltage (V_{IN})	+2.3V to 5.5V
Enable/Select Voltage (V_{EN}/V_{SEL})	0V to V_{IN}
Junction Temperature (T_J)	-40°C to +125°C
Junction Thermal Resistance	
1.6mmx1.6mm Thin MLF-6 (θ_{JA})	92°C/W

Electrical Characteristics⁽⁵⁾

$V_{IN} = V_{EN} = V_{OUT} + 1V$; $C_{IN} = C_{OUT} = 1\mu F$; $I_{OUT} = 100\mu A$; $T_J = 25^\circ C$, **bold** values indicate -40°C to +125°C, unless noted.

Parameter	Condition	Min	Typ	Max	Units
Output Voltage Accuracy	Variation from nominal V_{OUT}	-1.5		+1.5	%
	Variation from nominal V_{OUT}	-2.0		+2.0	%
Line Regulation	$V_{IN} = V_{OUT} + 1V$ to 5.5V, $I_{OUT} = 100\mu A$		0.01	0.3	%/V
Load Regulation ⁽⁶⁾	$I_{OUT} = 100\mu A$ to 150mA		0.05	1	%
Dropout Voltage ⁽⁷⁾	$I_{OUT} = 50mA$		25		mV
	$I_{OUT} = 100mA$		55		mV
	$I_{OUT} = 150mA$		85	150	mV
Ground Pin Current ⁽⁸⁾	$I_{OUT} = 100\mu A$ to 150mA		24	35	μA
Ground Pin Current in Shutdown	$V_{EN} = 0V$		0.01	1	μA
Ripple Rejection	$f = 1kHz$; $C_{OUT} = 1\mu F$; $I_{OUT} = 150mA$		65		dB
	$f = 20kHz$; $C_{OUT} = 1\mu F$; $I_{OUT} = 150mA$		50		dB
Current Limit	$V_{OUT} = 0V$	275	475	750	mA
Output Voltage Noise	$C_{OUT} = 1\mu F$, 10Hz to 100kHz		90		μV_{RMS}
Enable/Select Input					
Enable/Select Input Voltage	Logic Low			0.2	V
	Logic High	1.2			V
Enable/Select Input Current	$V_{IL} \leq 0.2V$		0.01	1	μA
	$V_{IH} \geq 1.2V$		0.01	1	μA
Turn-on Time	$C_{OUT} = 1\mu F$; $I_{OUT} = 150mA$		150	500	μs
Transition Time	$V_{EN} = \text{High}$; $V_{SEL} = \text{Transition from } 0V \text{ to } 1.2V$; V_{OUT} change from 1.8V to (3.2V-10%)		35	100	μs
	$V_{EN} = \text{High}$; $V_{SEL} = \text{Transition from } 1.2V \text{ to } 0V$; V_{OUT} change from 3.2V to (1.8V+10%)		45	100	μs

Notes:

- Exceeding the absolute maximum rating may damage the device.
- The device is not guaranteed to function outside its operating rating.
- The maximum allowable power dissipation of any T_A (ambient temperature) is $P_{D(max)} = (T_{J(max)} - T_A) / \theta_{JA}$. Exceeding the maximum allowable power dissipation will result in excessive die temperature, and the regulator will go into thermal shutdown.
- Devices are ESD sensitive. Handling precautions recommended. Human body model, 1.5k Ω in series with 100pF.
- Specification for packaged product only.
- Regulation is measured at constant junction temperature using low duty cycle pulse testing; changes in output voltage due to heating effects are covered by the thermal regulation specification.
- Dropout voltage is defined as the input-to-output differential at which the output voltage drops 2% below its nominal V_{OUT} . For outputs below 2.3V, the dropout voltage is the input-to-output differential with the minimum input voltage 2.3V.
- Ground pin current is the regulator quiescent current. The total current drawn from the supply is the sum of the load current plus the ground pin current.

Typical Characteristics

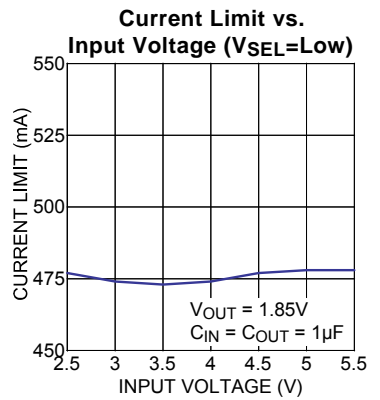
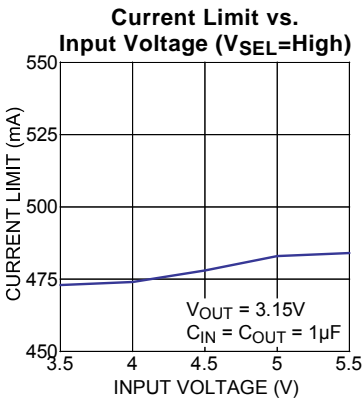
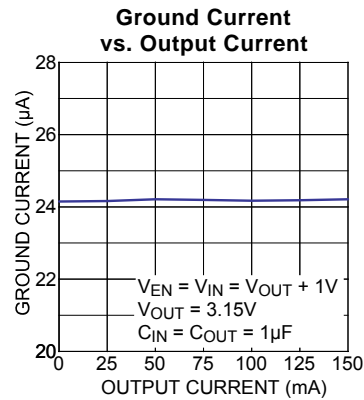
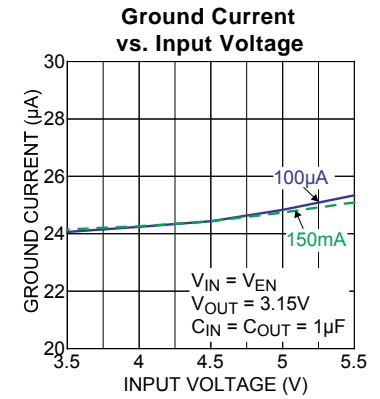
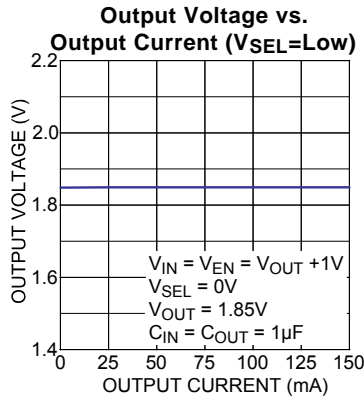
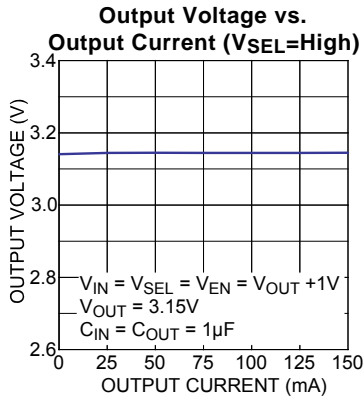
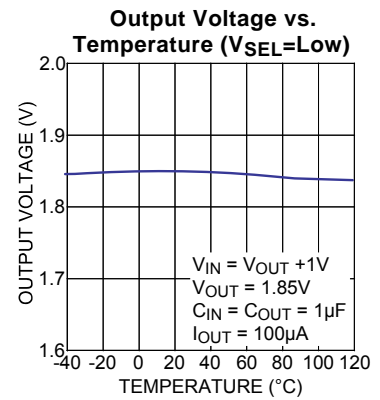
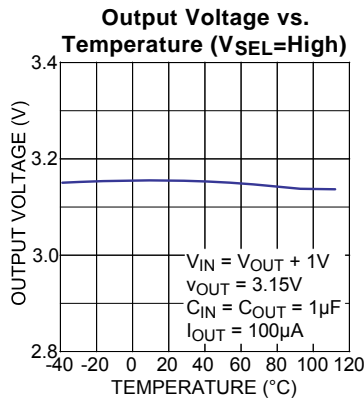
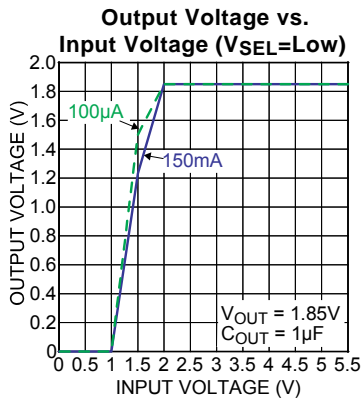
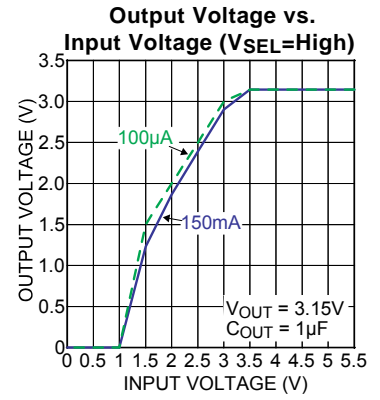
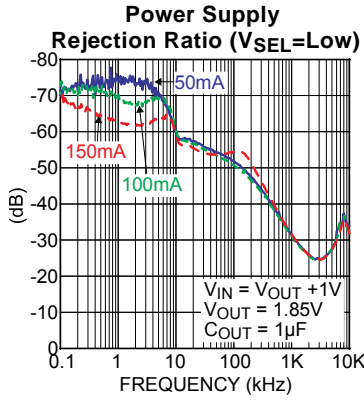
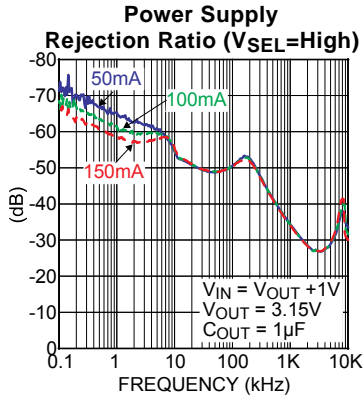

Typical Characteristics (continued)

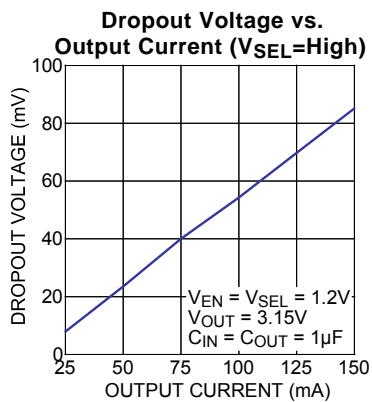
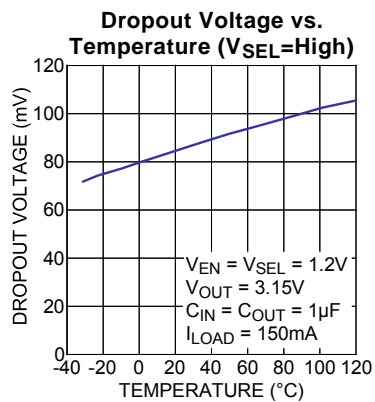

Functional Characteristics

Enable Turn-on (VSEL=High)

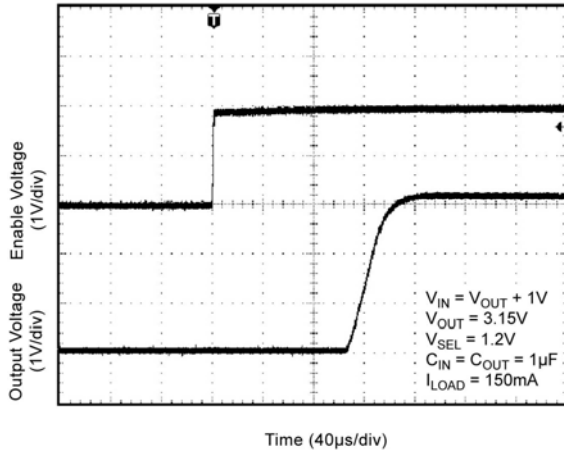

Enable Turn-on (VSEL=Low)

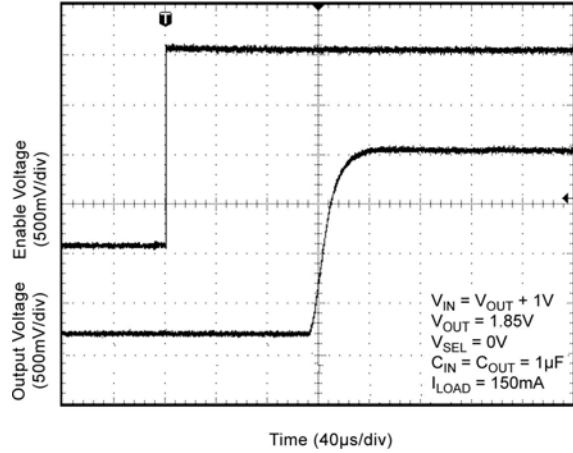

Line Transient (VSEL=High)

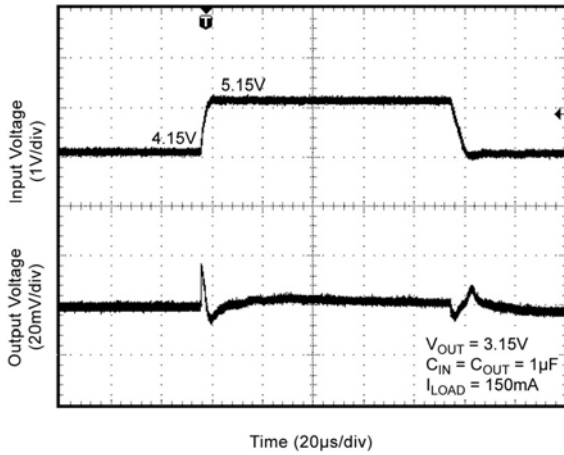

Line Transient (VSEL=Low)

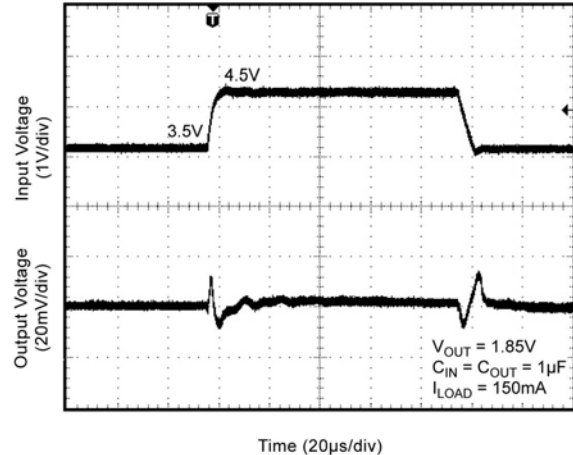

Load Transient (VSEL=High)

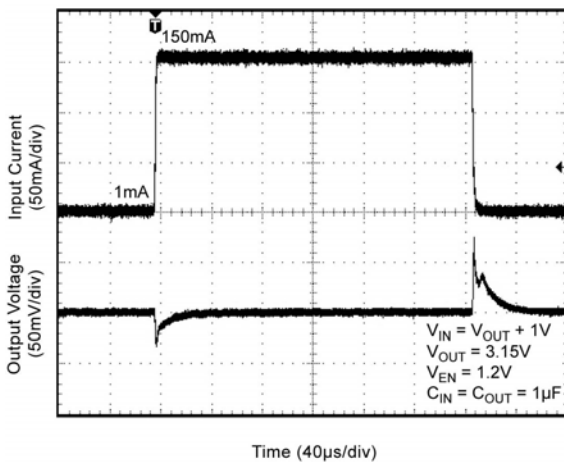

Load Transient (VSEL=Low)

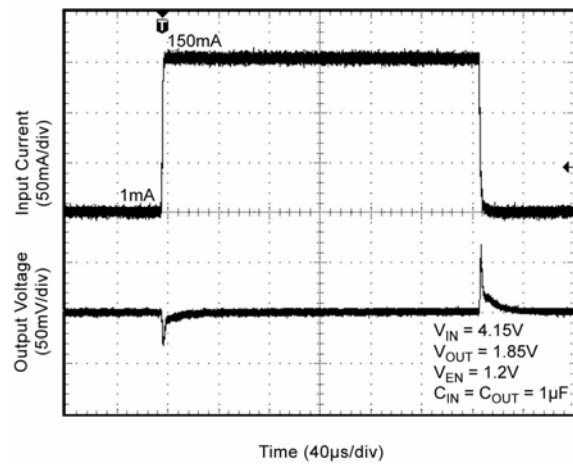

Functional Characteristics (continued)

Voltage Select Function

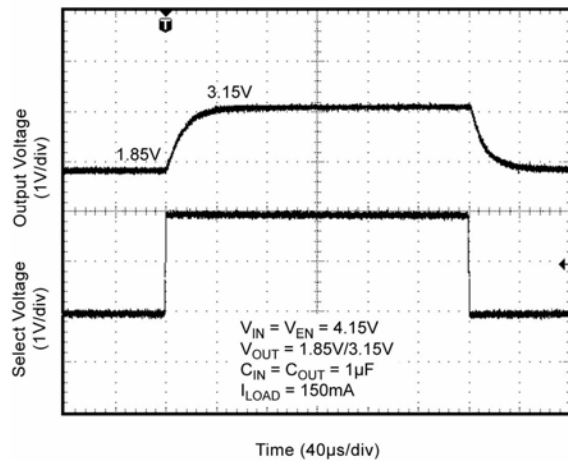

Functional Diagram

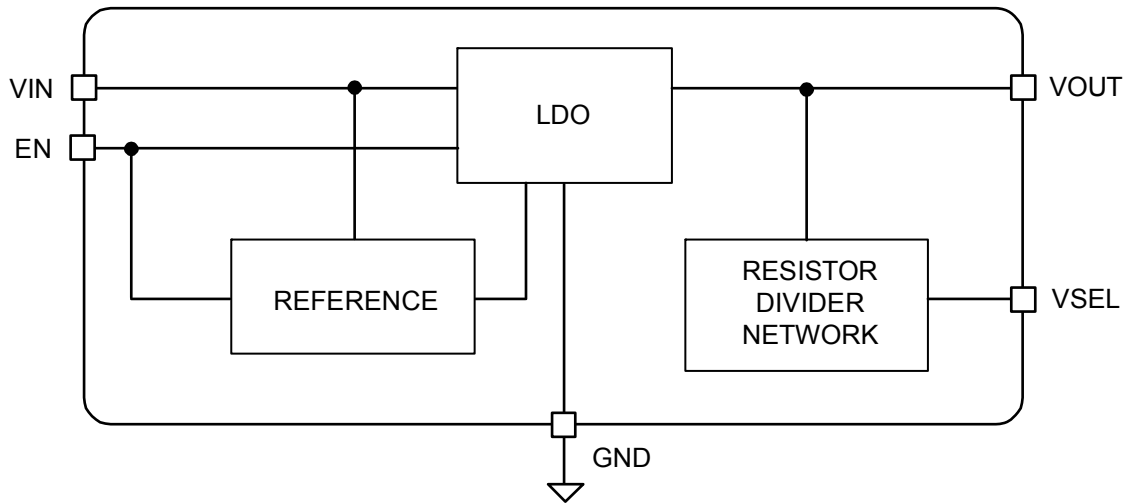

MIC5304 Block Diagram

Application Information

The MIC5304 is a low quiescent current voltage selectable LDO. The regulator is capable of sourcing 150mA of output current with a low quiescent current of 24µA. A logic input signal selects the output between two preset voltages. The MIC5304 regulator is fully protected from damage due to fault conditions, offering linear current limiting and thermal shutdown.

Input Capacitor

The MIC5304 is a high-performance, high bandwidth device. Therefore, it requires a well bypassed input supply for optimal performance. An input capacitor of 1µF is required from the input to ground to provide stability. Low-ESR ceramic capacitors provide optimal performance at a minimum of space. Additional high-frequency capacitors, such as small-valued NPO dielectric-type capacitors, help filter out high-frequency noise and are good practice in any RF-based circuit. X5R or X7R dielectrics are recommended for the input capacitor. Y5V dielectrics lose most of their capacitance over temperature and are therefore, not recommended.

Output Capacitor

The MIC5304 requires an output capacitor of 1µF or greater to maintain stability. The design is optimized for use with low-ESR ceramic chip capacitors. High ESR capacitors may cause high frequency oscillation. The output capacitor can be increased, but performance has been optimized for a 1µF ceramic output capacitor and does not improve significantly with larger capacitance.

X7R/X5R dielectric-type ceramic capacitors are recommended because of their temperature performance. X7R-type capacitors change capacitance by 15% over their operating temperature range and are the most stable type of ceramic capacitors. Z5U and Y5V dielectric capacitors change value by as much as 50% and 60%, respectively, over their operating temperature ranges. To use a ceramic chip capacitor with Y5V dielectric, the value must be much higher than an X7R ceramic capacitor to ensure the same minimum capacitance over the equivalent operating temperature range.

Enable/Shutdown

The MIC5304 is provided with an active-high enable pin that allows the regulator to be enabled. Forcing the enable pin low disables the regulator and sends it into a “zero” off-mode-current state. In this state, current consumed by the regulator goes nearly to zero. The active-high enable pin uses CMOS technology and the enable pin cannot be left floating; a floating enable pin may cause an indeterminate state on the output.

Voltage Select

The voltage select pin is used to select the output voltage

between two voltages. A logic high signal sets the output to the higher voltage; while a logic low signal selects the lower output voltage. The voltage select pin cannot be left floating; a floating pin may cause an indeterminate state on the output.

Thermal Considerations

The MIC5304 is designed to provide 150mA of continuous current in a very small package. Maximum ambient operating temperature can be calculated based on the output current and the voltage drop across the part. For example if the input voltage is 3.6V, the output voltage is 3.15V with V_{SEL} set high and 1.85V with V_{SEL} low, and the output current = 150mA. The lower output voltage should be used for power dissipation calculations as this is the worst case situation. The actual power dissipation of the regulator circuit can be determined using the equation:

$$P_D = (V_{IN} - V_{OUT}) I_{OUT} + V_{IN} I_{GND}$$

Because this device is CMOS and the ground current is typically <100µA over the load range, the power dissipation contributed by the ground current is < 1% and can be ignored for this calculation.

$$P_D = (3.6V - 1.85V) \times 150mA$$

$$P_D = 0.2625W$$

To determine the maximum ambient operating temperature of the package, use the junction-to-ambient thermal resistance of the device and the following basic equation:

$$P_{D(MAX)} = \left(\frac{T_{J(MAX)} - T_A}{\theta_{JA}} \right)$$

$T_{J(max)} = 125^\circ\text{C}$, and the maximum junction temperature of the die, θ_{JA} , thermal resistance = 92°C/W .

Substituting P_D for $P_{D(max)}$ and solving for the ambient operating temperature will give the maximum operating conditions for the regulator circuit. The junction-to-ambient thermal resistance for the minimum footprint is 92°C/W .

The maximum power dissipation must not be exceeded for proper operation.

For example, when operating the MIC5304-XDYMT at an input voltage of 3.6V and 150mA load with a minimum footprint layout, the maximum ambient operating temperature T_A can be determined as follows:

$$0.2625W = (125^\circ\text{C} - T_A)/(92^\circ\text{C/W})$$

$$T_A = 100^\circ\text{C}$$

Therefore, a 3.15/1.85V application with a 150mA output current can accept an ambient operating temperature of 100°C in a 1.6mm x 1.6mm MLF[®] package. For a full discussion of heat sinking and thermal effects on voltage regulators, refer to the “Regulator Thermals” section of *Micrel's Designing with Low-Dropout Voltage Regulators* handbook. This information can be found on Micrel's website at: http://www.micrel.com/_PDF/other/LDOBK_ds.pdf

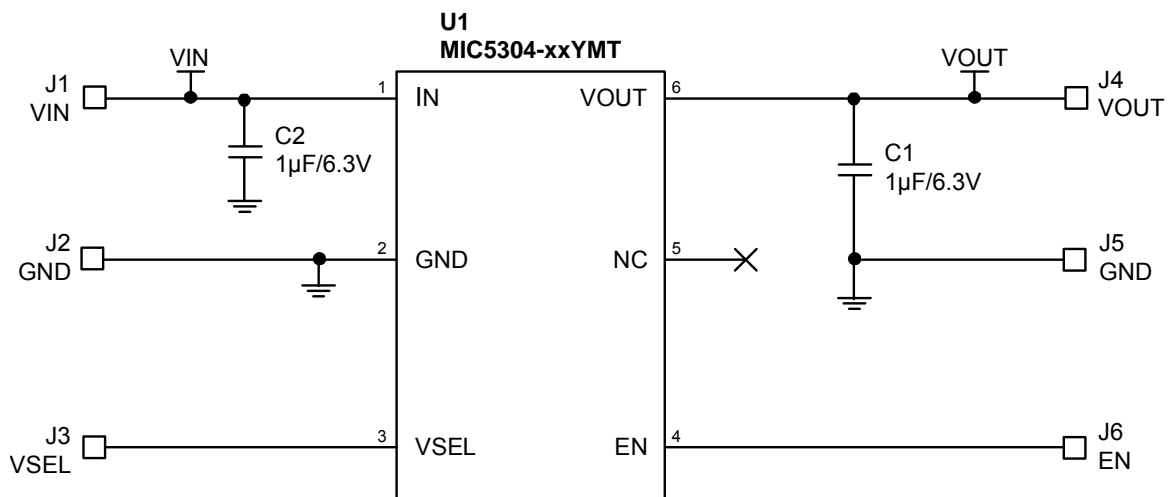

Bill of Materials

Item	Part Number	Manufacturer	Description	Qty.
C1, C2	C1608X5R1A105K	TDK ⁽¹⁾	Capacitor, 1µF, 6.3V, X5R, Size 0603	2
U1	MIC5304-xxYMT	Micrel, Inc. ⁽²⁾	150mA LDO with Selectable Output Voltage	1

Notes:

1. TDK : www.tdk.com
2. Micrel, Inc.: www.micrel.com

PCB Layout Recommendations

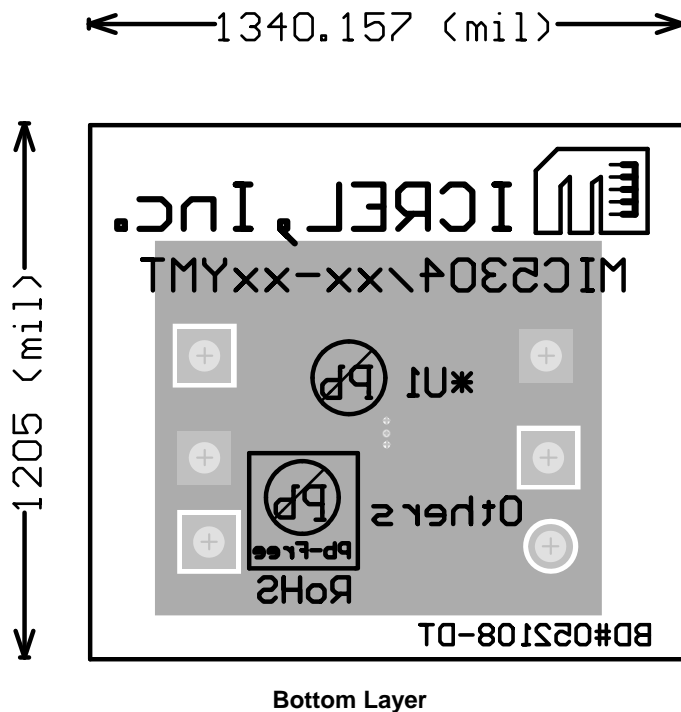
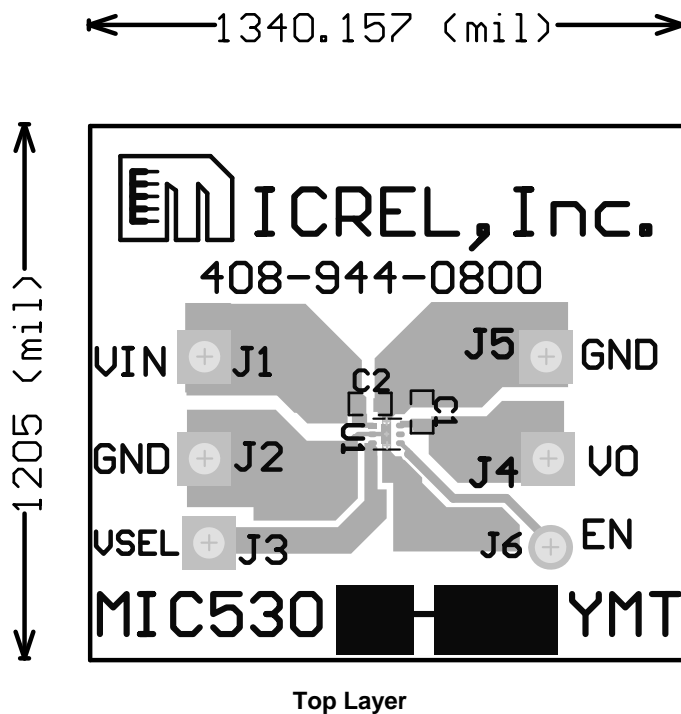

Package Information

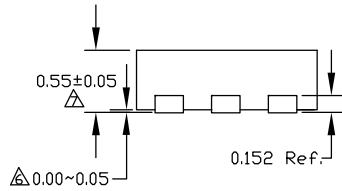
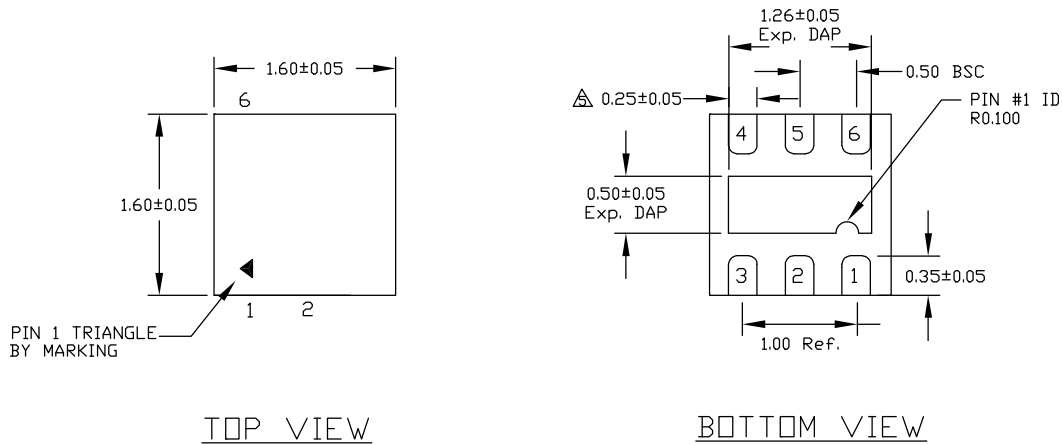

- NOTE:
1. ALL DIMENSIONS ARE IN MILLIMETERS.
 2. MAX. PACKAGE WARPAGE IS 0.05 mm.
 3. MAXIMUM ALLOWABLE BURRS IS 0.076 mm IN ALL DIRECTIONS.
 4. PIN #1 ID ON TOP WILL BE LASER/INK MARKED.
- △ DIMENSION APPLIES TO METALIZED TERMINAL AND IS MEASURED BETWEEN 0.20 AND 0.25 mm FROM TERMINAL TIP.
- △ APPLIED ONLY FOR TERMINALS.
- △ APPLIED FOR EXPOSED PAD AND TERMINALS.

6-Pin 1.6mm x 1.6mm Thin MLF® (MT)

MICREL, INC. 2180 FORTUNE DRIVE SAN JOSE, CA 95131 USA
 TEL +1 (408) 944-0800 FAX +1 (408) 474-1000 WEB <http://www.micrel.com>

The information furnished by Micrel in this data sheet is believed to be accurate and reliable. However, no responsibility is assumed by Micrel for its use. Micrel reserves the right to change circuitry and specifications at any time without notification to the customer.

Micrel Products are not designed or authorized for use as components in life support appliances, devices or systems where malfunction of a product can reasonably be expected to result in personal injury. Life support devices or systems are devices or systems that (a) are intended for surgical implant into the body or (b) support or sustain life, and whose failure to perform can be reasonably expected to result in a significant injury to the user. A Purchaser's use or sale of Micrel Products for use in life support appliances, devices or systems is a Purchaser's own risk and Purchaser agrees to fully indemnify Micrel for any damages resulting from such use or sale.

© 2008 Micrel, Incorporated.