

### General Description

The MIC184 is a versatile digital thermal supervisor capable of measuring temperature using either its own internal sensor or an inexpensive external sensor. A 2-wire serial interface is provided to allow communication with either I<sup>2</sup>C or SMBus masters. This device is a pin-for-pin and software compatible upgrade for the industry standard LM75.

Additional features include remote temperature measurement capability, and interrupt status and mask bits in the chip's configuration register for software polling. The open-drain interrupt output pin can be used as either an overtemperature alarm or thermostatic control signal. Three programmable address pins permit users to multidrop up to 8 devices along the 2-wire bus, allowing simple distributed temperature sensing networks. Superior performance, low power and small size makes the MIC184 an excellent choice for the most demanding thermal management applications.

### Features

- Measures local and remote temperatures
- Pin and software backward compatible to LM75
- 9-bit sigma-delta ADC
- 2-wire I<sup>2</sup>C/SMBus compatible interface
- Programmable thermostatic settings for either internal or external zone
- Open-drain comparator/interrupt output pin
- Interrupt mask and status bits
- Low-power shutdown mode
- Fail-safe response to diode faults
- 2.7V to 5.5V power supply range
- Up to 8 devices may share the same bus
- 8-Lead SOP and MSOP Packages

### Applications

- Desktop, Server and Notebook Computers
- Printers and Copiers
- Test and measurement equipment
- Consumer electronics

### Ordering Information

Part Number	Temperature Range	Package	Pb-FREE
MIC184BM	-55°C to +125°C	8-lead SOIC	
MIC184BMM	-55°C to +125°C	8-lead MSOP	
MIC184YM	-55°C to +125°C	8-lead SOIC	X
MIC184YMM	-55°C to +125°C	8-lead MSOP	X

### Typical Application

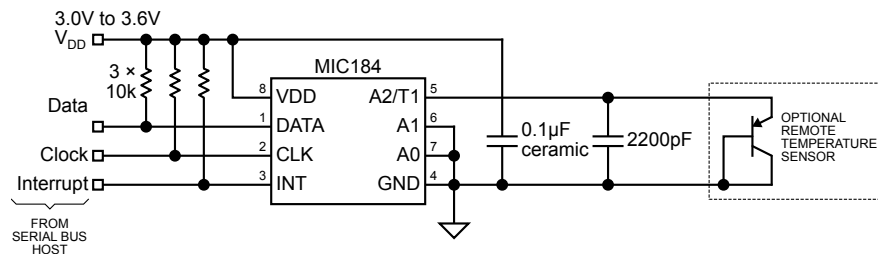

**2-Channel SMBus Temperature Measurement System**

## Pin Configuration

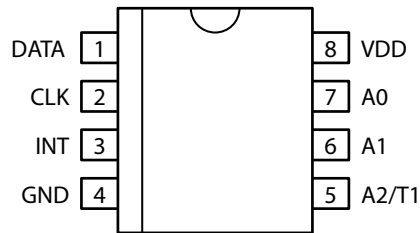

## Pin Description

Pin Number	Pin Name	Pin Function
1	DATA	Data (Digital I/O): Open-drain. Serial data input/output.
2	CLK	Clock (Digital Input): The host provides the serial bit clock on this input.
3	INT	Interrupt (Digital Output): Open-drain. Interrupt or thermostat output.
4	GND	Ground: Power and signal return for all IC functions.
5	A2/T1	Address Bit 2 (Digital Input): Slave address selection input. See "Slave Address Truth Table." Temperature Sensor 1 (Analog Input): Input from remote temperature sensor (diode junction).
6	A1	Address Bit 1 (Digital Input): Slave address selection input. See "Slave Address Truth Table."
7	A0	Address Bit 0 (Digital Input): Slave address selection input. See "Slave Address Truth Table."
8	VDD	Supply (Analog Input): Power supply input to the IC.

**Absolute Maximum Ratings** (Note 1)

Power Supply Voltage, $V_{DD}$	6.0V
Voltage on Any Pin	-0.3V to $V_{DD}+0.3V$
Current Into Any Pin	$\pm 6mA$
Power Dissipation, $T_A = +125^\circ C$	30mW
Junction Temperature	+150°C
Storage Temperature	-65°C to +150°C
<b>ESD Ratings (Note 3)</b>	
Human Body Model	700V
Machine Model	100V
<b>Soldering</b>	
Vapor Phase (60 sec.)	+220°C $\pm 5^\circ C$
Infrared (15 sec.)	+235°C $\pm 5^\circ C$

**Operating Ratings** (Note 2)

Power Supply Voltage, $V_{DD}$	+2.7V to +5.5V
Ambient Temperature Range ( $T_A$ )	-55°C to +125°C
<b>Package Thermal Resistance (<math>\theta_{JA}</math>)</b>	
SOP	+152°C/W
MSOP	+206°C/W

**Electrical Characteristics**

$2.7V \leq V_{DD} \leq 5.5$ ;  $T_A = +25^\circ C$ , **bold** values indicate  $-55^\circ C \leq T_A \leq +125^\circ C$ , **Note 4**; unless noted.

Symbol	Parameter	Condition	Min	Typ	Max	Units
<b>Power Supply</b>						
$I_{DD}$	Supply Current	INT open, A2, A1, A0 = $V_{DD}$ or GND, CLK = DATA = high, normal mode		340	<b>500</b>	$\mu A$
		shutdown mode, CLK = 100kHz		2.5		$\mu A$
		INT open, A2, A1, A0 = $V_{DD}$ or GND, CLK = DATA = high, shutdown mode		1	<b>10</b>	$\mu A$
$t_{POR}$	Power-On Reset Time	$V_{DD} > V_{POR}$		15	<b>100</b>	$\mu s$
$V_{POR}$	Power-On Reset Voltage	all registers reset to default values, A/D conversions initiated		2.0	<b>2.7</b>	V
$V_{HYST}$	Power-On Reset Hysteresis Voltage			250		mV
<b>Temperature-to-Digital Converter Characteristics</b>						
	Accuracy—Local Temperature <b>Note 5, 6</b>	$0^\circ C \leq T_A \leq +100^\circ C$ , INT open, $3V \leq V_{DD} \leq 3.6V$		$\pm 1$	<b><math>\pm 2</math></b>	$^\circ C$
		$-55^\circ C \leq T_A \leq +125^\circ C$ , INT open, $3V \leq V_{DD} \leq 3.6V$		$\pm 2$	<b><math>\pm 3</math></b>	$^\circ C$
	Accuracy—Remote Temperature <b>Note 5, 6, 7</b>	$0^\circ C \leq T_D \leq +100^\circ C$ , INT open, $3V \leq V_{DD} \leq 3.6V$ , $0^\circ C \leq T_A \leq +85^\circ C$		$\pm 1$	<b><math>\pm 3</math></b>	$^\circ C$
		$-55^\circ C \leq T_D \leq +125^\circ C$ , INT open, $3V \leq V_{DD} \leq 3.6V$ , $0^\circ C \leq T_A \leq +85^\circ C$		$\pm 2$	<b><math>\pm 5</math></b>	$^\circ C$
$t_{CONV}$	Conversion Time, <b>Note 5</b>	local temperature		100	<b>160</b>	ms
		remote temperature		200	<b>320</b>	ms
<b>Remote Temperature Input (T1)</b>						
$I_F$	Current to External Diode <b>Note 5</b>	high level		224	<b>400</b>	$\mu A$
		low level	<b>7.5</b>	14		$\mu A$
<b>Address Inputs (A2/T1, A1, A0)</b>						
$V_{IL}$	Low Input Voltage	$2.7V \leq V_{DD} \leq 5.5V$			<b>0.6</b>	V
$V_{IH}$	High Input Voltage	$2.7V \leq V_{DD} \leq 5.5V$	<b>2.0</b>			V
$C_{IN}$	Input Capacitance			10		pF
$I_{LEAK}$	Input Current			$\pm 0.01$	$\pm 1$	$\mu A$
$I_{PD}$	Pulldown Current on A2/T1	A2 = $V_{DD}$ , flows for $t_{POR}$ at power-up		25		$\mu A$

Symbol	Parameter	Condition	Min	Typ	Max	Units
<b>Serial Data I/O Pin (DATA)</b>						
$V_{OL}$	Low Output Voltage	$I_{OL} = 3\text{mA}$			0.4	V
		$I_{OL} = 6\text{mA}$			0.8	V
$V_{IL}$	Low Input Voltage	$2.7\text{V} \leq V_{DD} \leq 5.5\text{V}$			$0.3V_{DD}$	V
$V_{IH}$	High Input Voltage	$2.7\text{V} \leq V_{DD} \leq 5.5\text{V}$	$0.7V_{DD}$			V
$C_{IN}$	Input Capacitance			10		pF
$I_{LEAK}$	Input current			$\pm 0.01$	$\pm 1$	$\mu\text{A}$
<b>Serial Clock Input (CLK)</b>						
$V_{IL}$	Low Input Voltage	$2.7\text{V} \leq V_{DD} \leq 5.5\text{V}$			$0.3V_{DD}$	V
$V_{IH}$	High Input Voltage	$2.7\text{V} \leq V_{DD} \leq 5.5\text{V}$	$0.7V_{DD}$			V
$C_{IN}$	Input Capacitance			10		pF
$I_{LEAK}$	Input current			$\pm 0.01$	$\pm 1$	$\mu\text{A}$
<b>Status Output (INT)</b>						
$V_{OL}$	Low Output Voltage, <b>Note 8</b>	$I_{OL} = 3\text{mA}$			0.4	V
		$I_{OL} = 6\text{mA}$			0.8	V
$t_{INT}$	Interrupt Propagation Delay, <b>Note 5</b>	from $TEMP > T_{SET}$ , $FQ = 00$ to $INT < V_{OL}$ , $R_{PULLUP} = 10\text{k}\Omega$ ; POL bit = 0			$t_{CONV}+1$	$\mu\text{s}$
$t_{nINT}$	Interrupt Reset Propagation Delay, <b>Note 5</b>	from any register read to $INT > V_{OH}$ , $R_{PULLUP} = 10\text{k}\Omega$ ; POL bit = 0			1	$\mu\text{s}$
$T_{SET}$	Default $T_{SET}$ Value	$t_{POR}$ after $V_{DD} > V_{POR}$ , <b>Note 9</b>	80	80	80	$^{\circ}\text{C}$
HYST	Default HYST Value	$t_{POR}$ after $V_{DD} > V_{POR}$ , <b>Note 9</b>	75	75	75	$^{\circ}\text{C}$
<b>Serial Interface Timing (Note 5)</b>						
$t_1$	CLK (Clock) Period		2.5			$\mu\text{s}$
$t_2$	Data In Setup Time to CLK High		100			ns
$t_3$	Data Out Stable After CLK Low		0			ns
$t_4$	DATA Low Setup Time to CLK Low	start condition	100			ns
$t_5$	DATA High Hold Time After CLK High	stop condition	100			ns

**Note 1.** Exceeding the absolute maximum rating may damage the device.

**Note 2.** The device is not guaranteed to function outside its operating rating.

**Note 3.** Devices are ESD sensitive. Handling precautions recommended.  
Human body model: 1.5k in series with 100pF. Machine model: 200pF, no series resistance.

**Note 4.** Final test on outgoing product is performed at  $T_A = \text{TBD}^{\circ}\text{C}$ .

**Note 5.** Guaranteed by design over the operating temperature range. Not 100% production tested.

**Note 6.** Accuracy specification does not include quantization noise, which may be as great as  $\pm 1/2\text{LSB}$  ( $\pm 1/4^{\circ}\text{C}$ ).

**Note 7.**  $T_D$  is the temperature of the remote diode junction. Testing is performed using a single unit of one of the transistors listed in Table 5.

**Note 8.** Current into the INT pin will result in self-heating of the MIC184. INT pin current should be minimized for best accuracy.

**Note 9.** This is the decimal representation of a binary data value.

## Timing Diagram

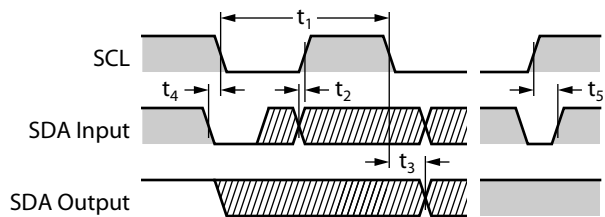

Serial Interface Timing

# Typical Characteristics

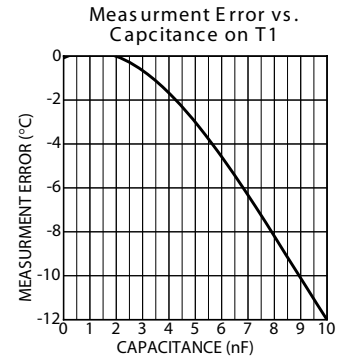
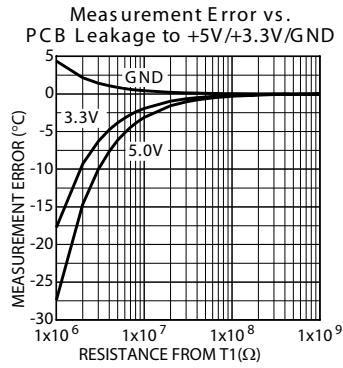
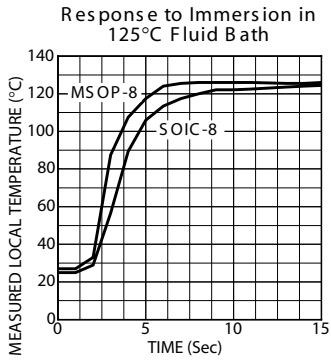
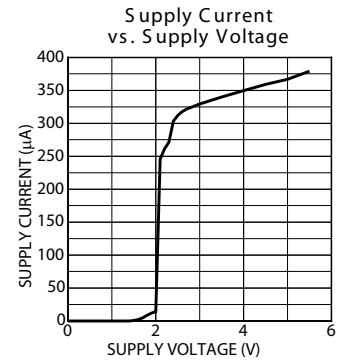
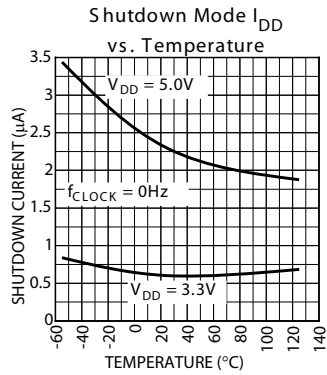
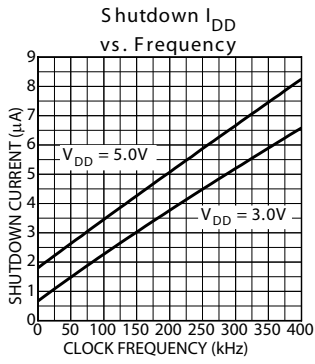
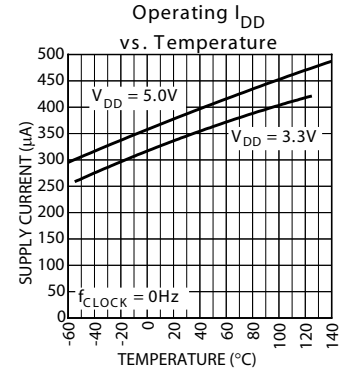
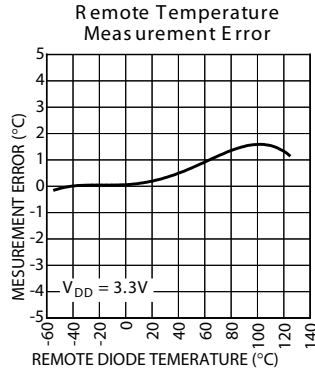
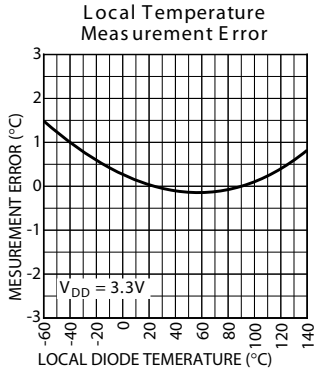

## Functional Diagram

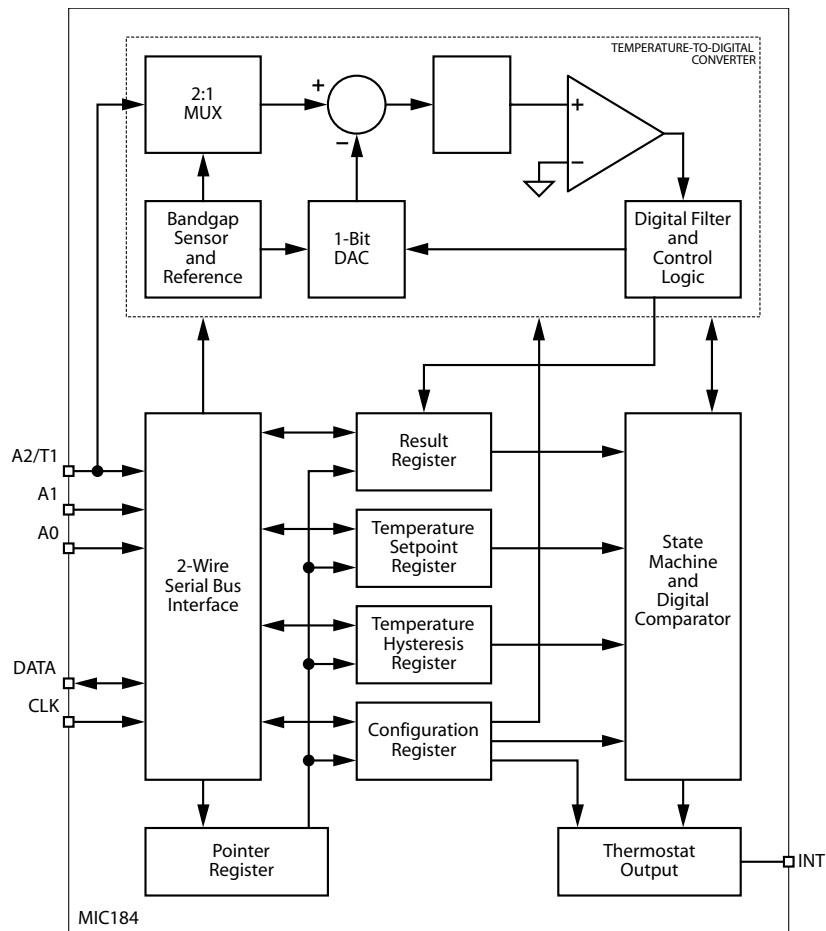

## Functional Description

### Pin Descriptions

#### **VDD**

Power supply input. See electrical specifications.

#### **GND**

Ground return for all MIC184 functions.

#### **CLK**

Clock input to the MIC184 from the two-wire serial bus. The clock signal is provided by the bus host and is shared by all devices on the bus.

#### **DATA**

Serial data I/O pin that connects to the two-wire serial bus. DATA is bidirectional and has an open-drain output driver. An external pull-up resistor or current source somewhere in the system is necessary on this line. This line is shared by all devices on the bus.

#### **A2/T1, A1, A0**

These inputs set the three least significant bits of the MIC184's 7-bit slave address. Each MIC184 will only respond to its own unique slave address, allowing the use of up to eight MIC184s on a single bus. A match between the MIC184's address and

the address specified in the serial bit stream must be made to initiate communication. A1 and A0 should be connected directly to  $V_{DD}$  or ground. When A2/T1 is used as an address bit input, it should also be tied to  $V_{DD}$  or ground. A2/T1 can alternatively connect to a remote temperature sensor. When A2/T1 is used for temperature measurements, an off-chip diode junction must be connected between A2/T1 and ground. In this case, internal circuitry will detect A2 as logic low, leaving four possible slave addresses. See "Temperature Measurement" and "Power On" for more information. A2/T1, A1, and A0 determine the slave address as shown in Table 1.

#### **INT**

Temperature events are indicated to external circuitry via this output. INT may be configured as active-low or active-high by the host. Operation of the INT output is controlled by the MODE and POL bits in the MIC184's configuration register. See "Comparator and Interrupt Modes" below. This output is open-drain and may be wire-ORed with other open-drain signals. Most systems will require a pull-up resistor or current source on this pin. If the IM bit in the configuration register is set, it prevents the INT output from sinking current. In I<sup>2</sup>C and SMBus systems, the IM bit is therefore an interrupt mask bit.

Inputs			MIC184 Slave Address	
A2/T1	A1	A0	Binary	Hex
0	0	0	100 1000 <sub>b</sub>	48 <sub>h</sub>
0	0	1	100 1001 <sub>b</sub>	49 <sub>h</sub>
0	1	0	100 1010 <sub>b</sub>	4A <sub>h</sub>
0	1	1	100 1011 <sub>b</sub>	4B <sub>h</sub>
1	0	0	100 1100 <sub>b</sub>	4C <sub>h</sub>
1	0	1	100 1101 <sub>b</sub>	4D <sub>h</sub>
1	1	0	100 1110 <sub>b</sub>	4E <sub>h</sub>
1	1	1	100 1111 <sub>b</sub>	4F <sub>h</sub>
diode	0	0	100 1000 <sub>b</sub>	48 <sub>h</sub>
diode	0	1	100 1001 <sub>b</sub>	49 <sub>h</sub>
diode	1	0	100 1010 <sub>b</sub>	4A <sub>h</sub>
diode	1	1	100 1011 <sub>b</sub>	4B <sub>h</sub>

**Table 1. MIC184 Slave Address Settings**

### Temperature Measurement

The temperature-to-digital converter for both internal and external temperature data is built around a switched current source and a 9-bit analog-to-digital converter. The temperature is calculated by measuring the forward voltage of a diode junction at two different bias current levels. An internal multiplexer directs the current source's output to either an internal or external diode junction.

The MIC184 uses two's-complement data to represent temperatures. If the MSB of a temperature value is 0, the temperature is  $\geq 0^{\circ}\text{C}$ . If the MSB is 1, the temperature is  $< 0^{\circ}$ . More detail on this is given in "Temperature Data Format" below. A *temperature event* results if the value in the temperature result register (TEMP) is greater than the value in the overtemperature setpoint register (T\_SET), or if it is less than the value in the temperature hysteresis register (T\_HYST).

The value of the ZONE bit in the configuration register determines whether readings are taken from the on-chip sensor or from the A2/T1 input. At power-up, the ZONE bit of the configuration register is set to zero. The MIC184 therefore monitors its internal temperature and compares the result

against the contents of T\_SET and T\_HYST. Setting the ZONE bit in CONFIG will result in the MIC184 acquiring temperature data from an external diode connected to the A2/T1 pin. This diode may be embedded in an integrated circuit (such as a CPU, ASIC, or graphics processor), or it may be a diode-connected discrete transistor. Once the new value is written to CONFIG, the A/D converter will begin a new conversion and return temperature data from the external zone. This data will be compared against T\_SET, T\_HYST, and the state of the Fault\_Queue (described below). The internal status bit (STS) and the INT output will then be updated accordingly. See "Applications Information" for more details on switching between zones.

### Diode Faults

The MIC184 is designed to respond in a fail-safe manner to hardware faults in the external sensing circuitry. If the connection to the external diode is lost, or the sense line (A2/T1) is shorted to  $V_{DD}$  or ground, the temperature data reported by the A/D converter will be forced to its full-scale value ( $+127.5^{\circ}\text{C}$ ). This will cause an overtemperature event to occur whenever  $T\_SET \leq +127.0^{\circ}\text{C}$  (0 1111 1110<sub>b</sub>). An interrupt will be generated if so enabled. The temperature reported for the external zone will remain 0 1111 1111<sub>b</sub> =  $+127.5^{\circ}\text{C}$  until the fault condition is cleared. This fault detection requires that the MIC184 complete the number of conversion cycles specified by Fault\_Queue. The MIC184 may therefore require one or more conversion cycles following power-on or a transition from shutdown to normal operation before reporting an external diode fault.

### Serial Port Operation

The MIC184 uses standard SMBus WRITE\_BYTE, READ\_BYTE, WRITE\_WORD, and READ\_WORD operations for communication with its host. The SMBus WRITE\_BYTE and WRITE\_WORD operations involve sending the device's slave address (with the R/W bit low to signal a write operation), followed by a command byte and one or two data bytes. The SMBus READ\_BYTE operation is similar, but is a composite write and read operation: the host first sends the device's slave address followed by the command byte, as in a write operation. A new "start" bit must then be sent to the MIC184, followed by a repeat of the slave address with the R/W bit (LSB) set to the high (read) state. The data to be read from

Command_Byte		Target Register	
Binary	Hex	Label	Description
0000 0000 <sub>b</sub>	00 <sub>h</sub>	TEMP	measured temperature result
0000 0001 <sub>b</sub>	01 <sub>h</sub>	CONFIG	configuration register
0000 0010 <sub>b</sub>	02 <sub>h</sub>	T_HYST	temperature hysteresis
0000 0011 <sub>b</sub>	03 <sub>h</sub>	T_SET	overtemperature setpoint
0000 0100 <sub>b</sub>	04 <sub>h</sub>	reserved	do not use
.	.		
.	.		
1111 1111 <sub>b</sub>	FF <sub>h</sub>		

**Table 2. MIC184 Register Addresses**

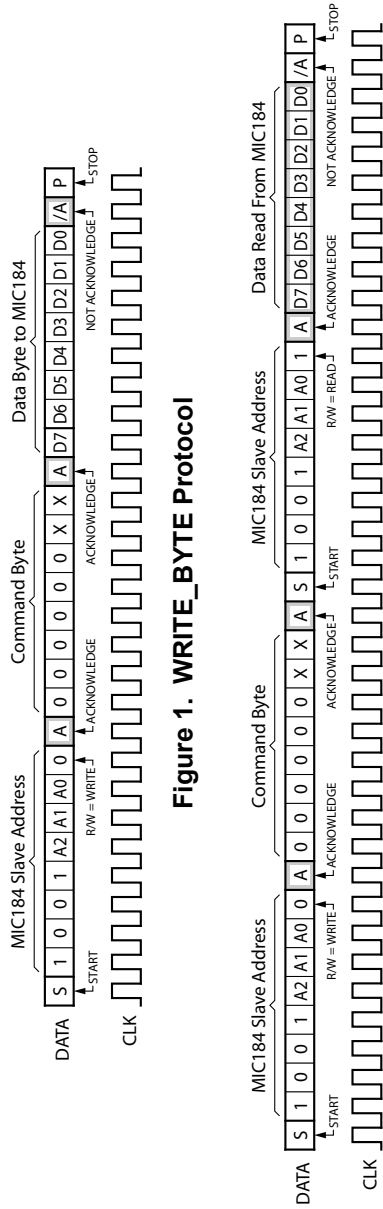

Figure 1. WRITE\_BYTE Protocol

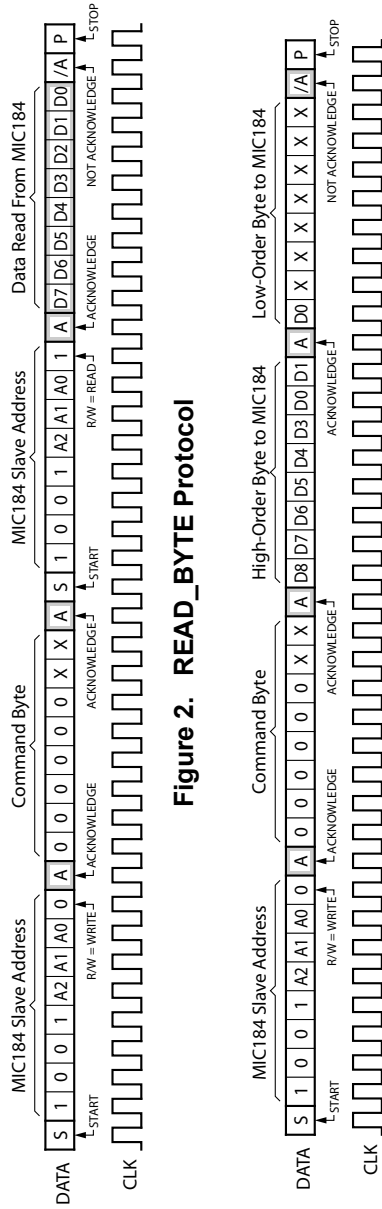

Figure 2. READ\_BYTE Protocol

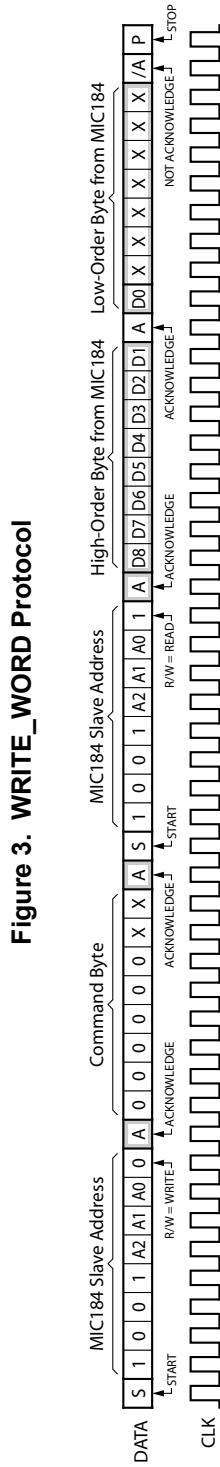

Figure 3. WRITE\_WORD Protocol

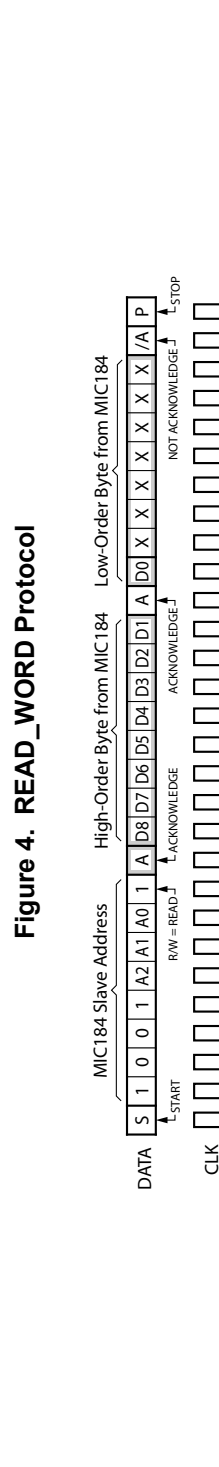

Figure 4. READ\_WORD Protocol



Figure 5. RECEIVE\_DATA from a 16-Bit Register





the MIC184 may then be clocked out. There is one exception to this rule: If the location latched in the pointer register from the last write operation is known to be correct (i.e., points to the desired register), then the "RECEIVE\_DATA" procedure may be used. To perform a RECEIVE\_DATA, the host sends an address byte to select the slave MIC184, and then retrieves the appropriate number (one or two) of data bytes. Figures 1 through 5 show the formats for these data read and data write procedures.

The command byte is 8 bits (1 byte) wide. This byte carries the address of the MIC184 register to be operated upon, and is stored in the MIC184's pointer register. The pointer register is a write-only register, which is implemented for backward compatibility to the National Semiconductor LM75 and similar devices. The command byte (pointer register) values corresponding to the various MIC184 register addresses are shown in Table 2. Command byte values other than 0000 00XX<sub>b</sub> = 00<sub>h</sub> through 03<sub>h</sub> are reserved, and should not be used.

The CONFIG register is 8 bits (1 byte) wide. Therefore, communications with the CONFIG register will at a minimum require a READ\_BYTE, WRITE\_BYTE, or a RECEIVE\_BYTE.

The TEMP, T\_HYST, and T\_SET registers are logically nine bits wide. Note, though, that these registers are physically two bytes (one SMBus word) wide within the MIC184. Properly communicating with the MIC184 involves a 16-bit READ\_WORD or RECEIVE\_WORD from, or WRITE\_WORD to, these registers. This is a requirement of the I<sup>2</sup>C/SMBus serial data protocols, which only allow data transfers to occur in multiples of eight bits.

### Temperature Data Format

The LSB of each 9-bit logical register represents 0.5°C. The values are in a two's complement format, wherein the most significant bit (D8) represents the sign: "0" for positive temperatures and "1" for negative temperatures. The seven least significant bits of each 16-bit physical register are undefined. Therefore, physical bits D6 through D0 of the data read from these registers must be masked off, and the resulting binary value right justified before using the data received. It is also possible to read only the first byte of any of these three registers, sacrificing 0.5°C of resolution in exchange for somewhat simpler data handling. However, all writes to the T\_SET and T\_HYST registers must be in the 16-bit WRITE\_WORD format. Table 3 shows examples of the data format used by the MIC184 for temperatures.

Temperature	Raw Binary	Masked Binary	Masked Hex
+125° C	0111 1101 0XXX XXXX	0 1111 1010 <sub>b</sub>	0FA <sub>h</sub>
+25° C	0001 1001 0XXX XXXX	0 0011 0010 <sub>b</sub>	032 <sub>h</sub>
+0.5° C	0000 0000 1XXX XXXX	0 0000 0001 <sub>b</sub>	001 <sub>h</sub>
0° C	0000 0000 0XXX XXXX	0 0000 0000 <sub>b</sub>	000 <sub>h</sub>
-0.5° C	1111 1111 1XXX XXXX	1 1111 1111 <sub>b</sub>	1FF <sub>h</sub>
-25° C	1110 0111 0XXX XXXX	1 1100 1110 <sub>b</sub>	1CE <sub>h</sub>
-40° C	1101 1000 0XXX XXXX	1 1011 0000 <sub>b</sub>	1B0 <sub>h</sub>
-55° C	1100 1001 0XXX XXXX	1 1001 0010 <sub>b</sub>	192 <sub>h</sub>

**Table 3. Digital Temperature Format**

### A/D Converter Timing

Whenever the MIC184 is not in its low power shutdown mode, the internal A/D converter (ADC) attempts to make continuous conversions unless interrupted by a bus transaction accessing the MIC184. When the MIC184 is accessed, the conversion in progress will be halted, and the partial result discarded. When the access of the MIC184 is complete the ADC will begin a new conversion cycle, with results valid  $t_{CONV}$  after that. Figure 6 shows this behavior.  $t_{CONV}$  is twice as long for external conversions as it is for internal conversions. This allows the use of a filter capacitor on the A2/T1 input without a loss of accuracy due to the resulting longer settling times.

### Power-On

When power is initially applied, the MIC184's internal registers are set to default states which make the MIC184 completely backward compatible with the LM75. Also at this time, the levels on the address inputs A2, A1, and A0 are read to establish the device's slave address. The MIC184's power-up default state can be summarized as follows:

- Normal-mode operation (MIC184 not in shutdown)
- ZONE is set to internal (on-chip temperature sensing)
- INT function is set to comparator mode
- INT output is set to active-low operation
- Fault\_Queue depth = 1
- Interrupts are enabled (IM = 0)
- T\_SET = +80°C; T\_HYST = +75°C

In order to accommodate the use of A2/T1 as a dual-purpose input, there is a weak pulldown on A2/T1 that will attempt to sink  $\approx 25\mu\text{A}$  from the pin to ground for  $t_{POR}$  following power-up of the MIC184. This allows the MIC184 to pull A2/T1 to a low state when a diode junction is connected from that pin to ground, and latch a zero as the A2 address value. If A2 is not to be used as a diode connection, it should be connected to  $V_{DD}$  or ground. Note that a fault in the external temperature sensor (if used) may not be reported until one or more conversion cycles have been completed following power-on. See DIODE FAULTS.

### Shutdown Mode

Setting the SHDN bit in the configuration register halts the otherwise continuous conversions by the A/D converter. The

MIC184's power consumption drops to 1 $\mu$ A typical in shutdown mode. All registers may be read from, or written to, while in shutdown mode. Serial bus activity will slightly increase the MIC184's power consumption.

Entering shutdown mode will not affect the state of INT when the device is in comparator mode (MODE = 0). However, if the device is shut down while in interrupt mode, the INT pin will be deasserted and the internal latch (STS) holding the interrupt status will be cleared. Therefore, no interrupts will be generated while the MIC184 is in shutdown mode, and the interrupt status will not be retained. It is important to note, however, that the *cause* of the last temperature event *will* be retained in the MIC184. This is described further in "Comparator and Interrupt Modes" below. The diode fault detection mechanism (see "Diode Faults") requires one or more A/D conversion cycles to detect external sensor faults. Hence, no diode faults will be detected while the device is in shutdown.

### Comparator and Interrupt Modes

Depending on the setting of the MODE bit in the configuration register, the INT output will behave either as an interrupt request signal or a thermostatic control signal. Thermostatic operation is known as *comparator mode*. The INT output is asserted whenever the measured temperature, as reported in the TEMP register, exceeds the threshold programmed in the T\_SET register for the number of conversions specified by Fault\_Queue (described below). In comparator mode, INT will remain asserted unless and until the measured temperature falls below the value in the T\_HYST register for Fault\_Queue conversions. No action on the part of the host is required for operation in comparator mode. Note that entering shutdown mode will not affect the state of INT when the device is in comparator mode.

In *interrupt mode*, once a temperature event has caused STS to be set, and the INT output to be asserted, they will not be automatically deasserted when the measured temperature falls below T\_HYST. They can only be deasserted by reading any of the MIC184's internal registers or by putting the device into SHUTDOWN mode. If the most recent temperature event was an overtemperature condition, STS will not be set again, and INT cannot be reasserted, until the device has detected that TEMP < T\_HYST. Similarly, if the most recent temperature event was an undertemperature condition, STS will in be set again, and INT cannot be reasserted, until the device has detected that TEMP > T\_SET. This keeps the internal logic of the MIC184 backward compatible with that of the LM75 and similar devices. *There is a software override for this:* while the MIC184 is operating in interrupt mode, the part can be unconditionally set to monitor for an overtemperature condi-

tion, regardless of what caused the last temperature event. This is done by clearing the MODE bit, and then immediately resetting it to 1. Following this sequence the next temperature event detected will be an overtemperature condition, regardless of whether the last temperature event was the result of an overtemperature or undertemperature condition.

In both modes, the MIC184 will be responsive to overtemperature events upon power up.

### Fault\_Queue

A Fault\_Queue (programmable digital filter) is provided in the MIC184 to prevent false tripping due to thermal or electrical noise. Two bits, CONFIG[4:3], set the depth of Fault\_Queue. Fault\_Queue then determines the number of consecutive temperature events (TEMP > T\_SET or TEMP < T\_HYST) which must occur in order for the condition to be considered valid. As an example, assume the MIC184 is in comparator mode, and CONFIG[4:3] is programmed with 10<sub>b</sub>. Then the measured temperature would have to exceed T\_SET for four consecutive A/D conversions before INT would be asserted or the status bit set. Similarly, TEMP would have to be less than T\_HYST for four consecutive conversions before INT would be reset.

Like any filter, the Fault\_Queue function also has the effect of delaying the detection of temperature events. In this example, it would take  $4 \times t_{CONV}$  to detect a temperature event. The depth of Fault\_Queue vs. D[4:3] of the configuration register is shown in Table 4.

### Handling Interrupts

The MIC184 may be either polled by the host, or request the host's attention via the INT pin. In the case of polled operation, the host periodically reads the contents of CONFIG to check the state of the status bit. The act of reading CONFIG clears the status bit, STS. If more than one event that sets the status bit occurs before the host polls the MIC184, only the fact that at least one such event has occurred will be apparent to the host.

If TEMP < T\_HYST or TEMP > T\_SET for Fault\_Queue conversions, the status bit STS will be set in the CONFIG register. This action cannot be masked. However, a temperature event will only generate an interrupt signal on INT if interrupts from the MIC184 are enabled (IM = 0 and MODE = 1 in the configuration register). Reading any register following an interrupt will cause INT to be deasserted, and will clear STS. The host should read the contents of the configuration register after receiving an interrupt to confirm that the MIC184 was the source of the interrupt. This is shown in Figure 7. As noted above, putting the device into shutdown mode will also deassert INT and clear STS. Therefore, this usually should not be done before completing the appropriate interrupt service routine(s).

Since temperature-to-digital conversions continue while INT is asserted, it is possible that temperature could change between the MIC184's assertion of its INT output and the host's response to the interrupt. It is good practice when servicing interrupts for the host to read the current temperature to confirm that the condition that caused the interrupt still exists.

CONFIG[4:3]	Fault_Queue Depth
00	1 conversion*
01	2 conversions
10	4 conversions
11	6 conversions

\* Default setting

**Table 4. Fault\_Queue Depth Settings**

### Interrupt Polarity Selection

The INT output can be programmed to behave as an active-low signal or an active-high signal. The default is active-low. INT polarity is selected by programming the appropriate value into the polarity bit (POL) in the CONFIG register. Clearing POL selects active-low interrupts; setting POL selects active-high interrupts. INT is an open-drain digital output and may be wire-ORed with other open-drain logic signals. Most applications will require a pull-up resistor on this pin.

Whether the CONFIG register's POL bit is set to provide a current-sinking (low) or high-Z (high) state at the INT pin when STS is high, writing a one to IM will put the INT pin into a high-Z state. This meets the requirement of an active-low interrupt for the SMBus, while making IM available as an INT-forcing bit for those applications which employ an active-high INT output (for example, software fan-control routines).

### LM75 Compatibility

The MIC184 can be used interchangeably with the LM75 in existing applications. The MIC184 offers several advantages

over the LM75:

- Ability to monitor a second, remote temperature
- Interrupt masking capability
- Status bit for software polling routines
- Lower quiescent current
- Supports single-byte reads from 16-bit registers
- No "inadvertent 8-bit read" bus lock-up issues

The three MSB's of the configuration register (which power up as zeroes) are used to access the MIC184's additional functions. These are reserved bits according to the LM75 specification and, for the LM75, must always be written as zeroes. The MSB of the MIC184's status register is a status flag that does not exist in the LM75. This bit will be set to one whenever an overtemperature event occurs. This bit would never be set by an LM75. Software should not depend on this bit being zero when using the MIC184 as an LM75 upgrade. If at power-up the measured temperature is higher than T\_SET, the status bit will be set following the first conversion by the A/D. See "Applications Information" for a method by which host software can use this fact to differentiate between an MIC184 and an LM75.

## Register Set and Programmer's Model

### Internal Register Set

Name	Description	Command Byte	Operation	Power-Up Default	
TEMP	measured temperature	00 <sub>h</sub>	9-bit read only	0 0000 0000 <sub>b</sub>	0° C <sup>(1)</sup>
CONFIG	configuration register	01 <sub>h</sub>	8-bit read/write	0000 0000 <sub>b</sub>	(Note 2)
T_HYST	hysteresis	02 <sub>h</sub>	9-bit read/write	0 1001 0110 <sub>b</sub>	+75° C
T_SET	temperature setpoint	03 <sub>h</sub>	9-bit read/write	0 1010 0000 <sub>b</sub>	+80° C

### Detailed Register Descriptions

CONFIG (8-Bit Read/Write)							
D[7]	D[6]	D[5]	D[4]	D[3]	D[2]	D[1]	D[0]
read only	read/write	read/write	read/write		read/write	read/write	read/write
interrupt status (STS)	interrupt mask <sup>(3)</sup> (IM)	temp select (ZONE)	fault queue depth (F_Q)		int polarity (POL)	CMP/INT mode (MODE)	S shutdown (SHDN)

Bits	Function	Operation
STS	interrupt status (read only)	1 = interrupt occurred, 0 = none
IM	interrupt mask	0 = enabled, 1 = disabled
ZONE	internal/remote temperature selection	1 = remote, 0 = internal
F_Q	Fault_Queue depth	00 = 1 conversion, 01 = 2 conversions, 10 = 4 conversions, 11 = 6 conversions
POL	INT output polarity selection	1 = active high, 0 = active low
MODE	comparator/interrupt mode selection for INT pin	1 = interrupt mode, 0 = comparator mode
SHDN	normal/shutdown operating mode selection	1 = shutdown, 0 = normal

Power-Up Default Value: 0000 0000<sub>b</sub> = 00<sub>h</sub><sup>(4)</sup>

- not in shutdown mode
- comparator mode
- INT = active low
- Fault\_Queue depth = 1
- local temperature zone
- interrupts enabled.

CONFIG Command Byte Address: 0000 0001<sub>b</sub> = 01<sub>h</sub>

(1) TEMP will contain measured temperature data for the selected zone after the completion of one conversion.

(2) After the first Fault\_Queue conversions are complete, the status bit will be set if TEMP < T\_HYST or TEMP > T\_SET.

(3) Setting IM forces the open-drain INT output into its high-Z state. See "INT Polarity Selection."

(4) After the first Fault\_Queue conversions are completed, the status bit will be set if TEMP < T\_HYST or TEMP > T\_SET.

**Temperature Result Register**

TEMP (9-Bit Read Only)															
D[15]	D[14]	D[13]	D[12]	D[11]	D[10]	D[9]	D[8]	D[7]	D[6]	D[5]	D[4]	D[3]	D[2]	D[1]	D[0]
MSB	bit 7	bit 6	bit 5	bit 4	bit 3	bit 2	bit 1	LSB	X	X	X	X	X	X	X
temperature data from ADC															

Bits	Function	Operation
D[15:7]	measured temperature data for selected zone	read only*

Power-Up Default Value:  $0\ 0000\ 0000_b = 0^\circ\text{C}^\dagger$

TEMP Command Byte Address:  $0000\ 0000_b = 00_h$

\* The value in TEMP is 9 logical bits in width, but due to the conventions of I<sup>2</sup>C/SMBus, it is represented by 16 serial bits. System software should ignore undefined bits D[6:0]. See "Serial Port Operation" and "Temperature Data Format" for more details.

† TEMP will contain measured temperature data for the selected zone after the completion of one conversion.

**Hysteresis Register**

T_HYST (9-Bit Read/Write)															
D[15]	D[14]	D[13]	D[12]	D[11]	D[10]	D[9]	D[8]	D[7]	D[6]	D[5]	D[4]	D[3]	D[2]	D[1]	D[0]
MSB	bit 7	bit 6	bit 5	bit 4	bit 3	bit 2	bit 1	LSB	X	X	X	X	X	X	X
temperature hysteresis setting															

Bits	Function	Operation
D[15:7]	temperature hysteresis setting	read/write*

T\_HYST Power-Up Default Value:  $0\ 1001\ 0110_b (+75^\circ\text{C})$

T\_HYST Command Byte Address:  $0000\ 0010_b = 02_h$

\* The value in T\_HYST is 9 logical bits in width, but due to the conventions of I<sup>2</sup>C/SMBus, it is represented by 16 serial bits. System software should ignore undefined bits D[6:0] during register reads. Bits [6:0] should be set to zero during register writes. See "Serial Port Operation" and "Temperature Data Format" for more details.

**Temperature Setpoint Register**

T_SET (9-Bit Read/Write)															
D[15]	D[14]	D[13]	D[12]	D[11]	D[10]	D[9]	D[8]	D[7]	D[6]	D[5]	D[4]	D[3]	D[2]	D[1]	D[0]
MSB	bit 7	bit 6	bit 5	bit 4	bit 3	bit 2	bit 1	LSB	X	X	X	X	X	X	X
overtemperature setpoint															

Bits	Function	Operation
D[15:7]	overtemperature comparator setpoint	read/write*

T\_SET Power-Up Default Value:  $0\ 1010\ 0000_b (+80^\circ\text{C})$

T\_SET Command Byte Address:  $0000\ 0011_b = 03_h$

\* The value in T\_SET is 9 logical bits in width, but due to the conventions of I<sup>2</sup>C/SMBus, it is represented by 16 serial bits. System software should ignore undefined bits D[6:0] during register reads. Bits [6:0] should be set to zero during register writes. See "Serial Port Operation" and "Temperature Data Format" for more details.

## Applications Information

### Switching Zones

The recommended procedure for switching between the internal and external zones is as follows:

1. Disable interrupts (if used) by setting the IM bit in CONFIG.
2. Read the CONFIG register to:
  - a) Verify no masked interrupt was pending ( $D[7] = 0$ )
  - b) Clear STS prior to switching zones
  - c) Hold the settings of CONFIG register for the current zone
3. Write the appropriate values to T\_SET and T\_HYST for the new zone.
4. Write to CONFIG as follows:
  - a) To toggle the ZONE bit (1 = remote, 0 = internal)
  - b) If interrupts are being used, step 4 should also clear MODE
5. If interrupts are being used, MODE must then be set to 1 and IM reset to 0

At the conclusion of the serial bus transaction for step 4, the A/D converter will begin a conversion cycle using the new zone setting. The next conversion cycle completed *after* the serial bus transaction for step 5 will result in the state of the INT output being updated (if enabled) for the new zone. Generally the MIC184's A/D converter operates continuously, but it will be halted and reset each time the part recognizes its slave address on the serial bus. Interrupted conversions will remain halted until the end of the host's communication with the MIC184. After the completion of step 5 and a delay of  $t_{CONV} \times Fault\_Queue$ , STS and INT will contain the results for the new zone. The above routine is extremely unlikely to miss a temperature event, as even one A/D conversion is typically much slower than the I<sup>2</sup>C/SMBus transactions that control the MIC184. See Figure 6: A/D Converter Timing.

Step 2(c) is recommended because the MIC184 has only one CONFIG register, corresponding to the active zone. In order to preserve data integrity for both zones, 2(c) allows the host to create a virtual CONFIG register for the inactive zone by dedicating one byte of memory to that purpose. Additional virtual registers may be created as needed by inserting additional reads as steps 2(d), 2(e), etc. These could for example correspond to the values in T\_SET and T\_HYST immediately prior to switching zones. Steps 4(b) and 5 ensure that the MIC184 will enter the new zone searching for an overtemperature event.

### Identifying an MIC184 by Software Test

The MIC184 and the LM75 each have an eight-bit CONFIG register. In LM75-type parts, no more than seven of

the eight bits of this register are used, and at least one bit (the MSB) will always return a zero. The MIC184 uses all eight bits of the CONFIG register: the MSB is the part's status bit (STS). A simple test by which the host can determine whether a system has an MIC184 installed, or is using a legacy LM75-type device, is to create a situation which will set the MSB in the MIC184's CONFIG register and then determine if the MSB is in fact set. Two examples of how this can be done are outlined below. The first is interrupt-driven, the second uses software polling. Note that both procedures generate one or more spurious interrupts. The code for these tests should therefore temporarily disable any affected interrupt routines.

#### {START Interrupt-Driven Test and Initialization Routine}

1. Disable the host's overtemperature and under-temperature interrupt handling routine. Redirect interrupts from the part under test to a handler for the interrupt that will be generated in steps (4) and (7) of this routine.
2. Write 0000 0010b (02h) to the CONFIG register. (The assumption is made that the host is an I<sup>2</sup>C or SMBus part, and therefore responds to an active-low interrupt request.)
3. Write 1100 1000 1000 0000b = C880h to T\_SET and T\_HYST. This corresponds to -55.5°C.
4. When the part has finished its first A/D conversion, INT will be asserted.
5. Read out the contents of the CONFIG register:
  - a) If the part is an MIC184, the MSB will be set to one (CONFIG = 1000 0010b = 82h).
  - b) If the part is a conventional LM75-type part, the MSB will be zero (CONFIG = 0000 0010b = 02h).
6. Write 0111 1111 1000 0000b = 7F80h to T\_SET and T\_HYST. This corresponds to +127.5°C.
7. When the part has finished its next A/D conversion, INT will be asserted a second time.
8. Read CONFIG again, to clear the interrupt request from step (7). This will also clear STS, if the part under test is an MIC184.
9. Based on the results of the test in step (4), do the following within 50ms total:
  - a) Set the CONFIG register as required.
  - b) Load T\_HYST with its operational value.
  - c) Load T\_SET with its operational value.
  - d) Set the host's interrupt handling routine back to overtemperature and under-temperature mode.

{END}

#### {START Polling-Based Test and Initialization Routine}

1. Temporarily disable the host's interrupt input

from the device under test.

2. Write 0000 0010b (02h) to the CONFIG register.
3. Write 1100 1000 1000 0000b = C880h to T\_SET and T\_HYST. This corresponds to -55.5°C.
4. Wait  $t_{conv}$  (160ms max.) for the part to finish at least one A/D conversion.
5. Read the contents of the CONFIG register:
  - a) If the part is an MIC184, the MSB will be set to one (CONFIG = 82h).
  - b) If the part is a conventional LM75-type part, the MSB will be zero (CONFIG = 02h).
6. Write 0111 1111 1000 0000b = 7F80h to T\_SET and T\_HYST. This corresponds to +127.5°C.
7. Wait an additional  $t_{conv}$  for the part to finish a second conversion.
8. Read CONFIG again, to clear the interrupt request from step (7). This will also clear STS, if the part under test is an MIC184.
9. Based on the results of the test in step (4), do the following four steps within 50ms total:
  - a) Set the CONFIG register as required.
  - b) Load T\_HYST with its operational value.
  - c) Load T\_SET with its operational value.
  - d) Re-enable the host's interrupt handling input from the part under test.

{END}

These routines force the device under test to generate an overtemperature fault (steps 3 and 4), followed by an undertemperature fault (steps 6 through 8). This sequence causes the device under test to exit the routine prepared to respond to an overtemperature condition. If being immediately prepared to detect an undertemperature condition upon exit is desired, swap steps 3 and 6 in each routine.

### Remote Diode Selection

Most small-signal PNP transistors with characteristics similar to the JEDEC 2N3906 will perform well as remote temperature sensors. Table 3 lists several examples of such parts. Micrel has tested those marked with a bullet for use with the MIC184.

### Minimizing Errors

#### Self-Heating

One concern when using a part with the temperature accuracy and resolution of the MIC184 is to avoid errors induced by

self-heating ( $V_{DD} \times I_{DD}$ ). In order to understand what level of error this might represent, and how to reduce that error, the dissipation in the MIC184 must be calculated, and its effects examined as a temperature error.

In most applications, the INT output will be low for at most a few milliseconds before the host sets it back to the high state, making its duty cycle low enough that its contribution to self-heating of the MIC184 is negligible. Similarly, the DATA pin will in all likelihood have a duty cycle of substantially below 25% in the low state. These considerations, combined with more typical device and application parameters, allow the following calculation of typical device self-heating in interrupt-mode:

$$P_D = (I_{DD(typ.)} 3.3V + 25\% I_{OL(data)} 0.3V + 1\% I_{OL(int)} 0.3V)$$

$$P_D = (0.3mA \times 3.3V + 25\% \times 1.5mA \times 0.3V + 1\% \times 1.5mA \times 0.3V)$$

$$\Delta T_J = 1.11mW \times 206^\circ C/W$$

**$\Delta T_J$  relative to  $T_A$  is 0.23°C**

If the part is to be used in comparator mode, calculations similar to those shown above (accounting for the expected value and duty cycle of  $I_{OL(int)}$ ) will give a good estimate of the device's self-heating error.

In any application, the best test is to verify performance against calculation in the final application environment. This is especially true when dealing with systems for which some of the thermal data, (for example, PC board thermal conductivity and/or ambient temperature), may be poorly defined or unavailable except by empirical means.

### Series Resistance

The operation of the MIC184 depends upon sensing the  $\Delta V_{CB-E}$  of a diode-connected PNP transistor ("diode") at two different current levels. For remote temperature measurements, this is done using an external diode connected between A2/T1 and ground.

Since this technique relies upon measuring the relatively small voltage difference resulting from two levels of current through the external diode, any resistance in series with the external diode will cause an error in the temperature reading from the MIC184. A good rule of thumb is this: for each ohm in series with the external transistor, there will be a 0.9°C error in the MIC184's temperature measurement. It is not difficult to keep the series resistance well below an ohm (typically 0.1Ω), so

Vendor	Part Number	Package	Tested
Fairchild	MMBT3906	SOT-23	●
On Semiconductor	MMBT3906L	SOT-23	●
Phillips Semiconductor	PMBT3906	SOT-23	●
Rohm Semiconductor	SST3906	SOT-23	
Samsung	KST3906-TF	SOT-23	
Zetex	FMMT3906	SOT-23	

**Table 5. Transistors Suitable for Remote Temperature Sensing Use**



in most systems this will not be an issue.

### Filter Capacitor Selection

When using a remote diode for temperature sensing, it is sometimes desirable to use a filter capacitor between the A2/T1 and GND pins of the MIC184. The use of this capacitor is recommended in environments with a significant high frequency noise (such as digital switching noise), or if long wires are used to connect to the remote diode. The maximum recommended total capacitance from the A2/T1 pin to GND is 2700pF. This usually suggests the use of a 2200pF NP0 or C0G ceramic capacitor with a 10% tolerance.

If the remote diode is to be at a distance of more than 6" ~ 12" from the MIC184, using a shielded cable (solid foil shield microphone cable is a good choice) for the connections to the diode can significantly help reduce noise pickup. Remember to subtract the cable's conductor-to-shield capacitance from the 2700pF maximum total capacitance.

### Layout Considerations

#### Local Mode Only Applications:

If the MIC184 is not going to be used with an external diode, the best layout is one which keeps it thermally coupled to the subsystem(s) whose temperature it must monitor, while avoiding any strong sources of EMI, RFI, or electrostatically coupled noise. Two of the most common examples of such sources are switching power supply transformers and CRTs.

#### Remote Mode Applications:

1. If the remote sensing capability of the MIC184 will be used in an application, place the MIC184 as close to the remote diode as possible, while taking care to avoid severe noise sources (high frequency power transformers, CRTs, memory and data busses, and the like).
2. Since any conductance from the various voltages on the PC Board and the A2/T1 pin can induce serious errors, it is good practice to guard the remote diode's emitter trace with a pair of ground traces. These ground traces should be returned to the MIC184's own ground pin. They should *not* be grounded at any other part of their run. However, it is *highly desirable to use these guard traces to carry the diode's own ground return back to the ground pin of the MIC184, thereby providing a Kelvin connection for the base of the diode. See Figure 8.*

3. *When using the MIC184 to sense the temperature of a processor or other device which has an integral on-board "diode" (e.g., Intel's Pentium® III), connect the emitter and base of the remote sensor to the MIC184 using the guard traces and Kelvin return shown in Figure 8. The collector of the remote "diode" is inaccessible to the user on these types of chips. To allow for this, the MIC184 has superb rejection of noise appearing from collector to GND, as long as the base to ground connection is relatively quiet.*
4. *Due to the small currents involved in the measurement of the remote diode's  $\Delta V_{BE}$ , it is important to adequately clean the PC board after soldering. This is most likely to show up as an issue in some situations where water-soluble soldering fluxes are used.*
5. *In general, wider traces for the ground and A2/T1 pins will help reduce susceptibility to radiated noise (wider traces are less inductive). Use trace widths and spacing of 10 mils wherever possible. Wherever possible, place a ground plane under the MIC184, and under the connections from the MIC184 to the remote diode. This will help guard against stray noise pickup.*
6. *Always place a good quality  $V_{DD}$  bypass capacitor directly adjacent to, or underneath, the MIC184. This part should be a 0.1 $\mu$ F ceramic capacitor. Surface-mount parts provide the best bypassing because of their low inductance.*
7. *When the MIC184 is being powered from particularly noisy power supplies, or from supplies which may have sudden high-amplitude spikes appearing on them, it can be helpful to add additional power supply filtering. This should be implemented as a 100 $\Omega$  resistor in series with the part's  $V_{DD}$  pin, and a 4.7 $\mu$ F, 6.3V electrolytic capacitor from  $V_{DD}$  to GND. See Figure 9.*

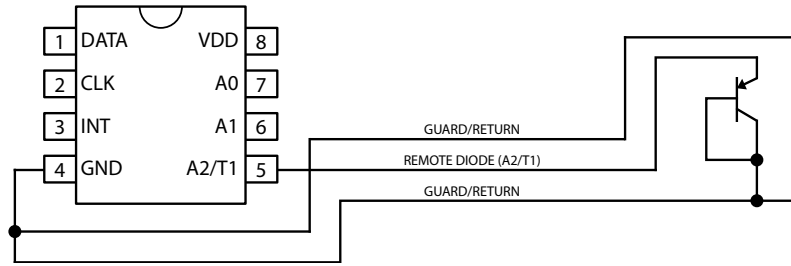

Figure 8. Guard Traces/Kelvin Ground Returns

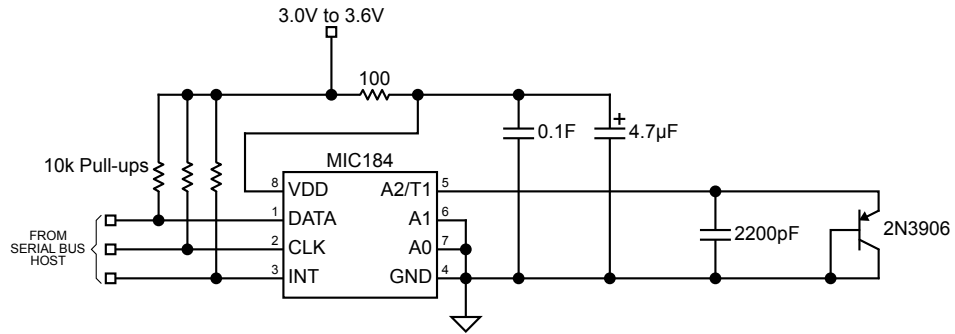
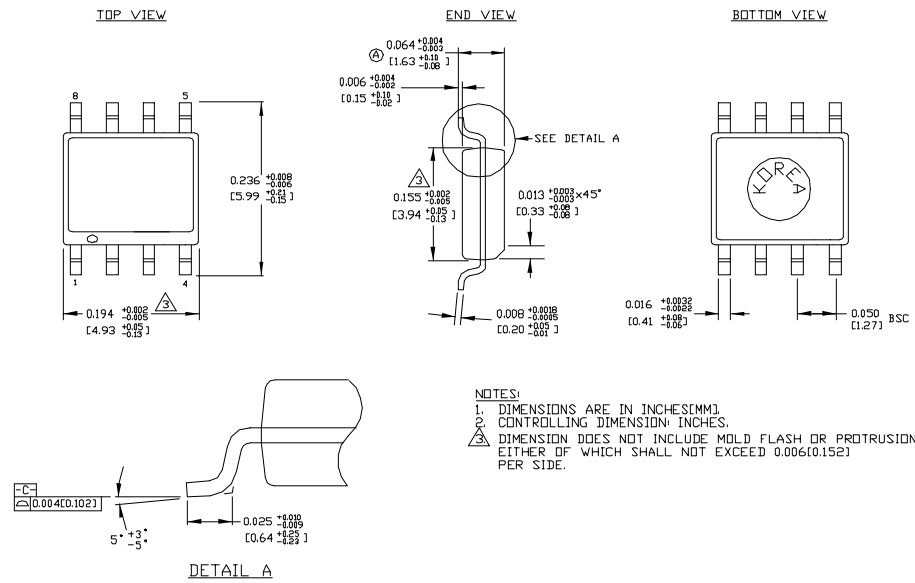
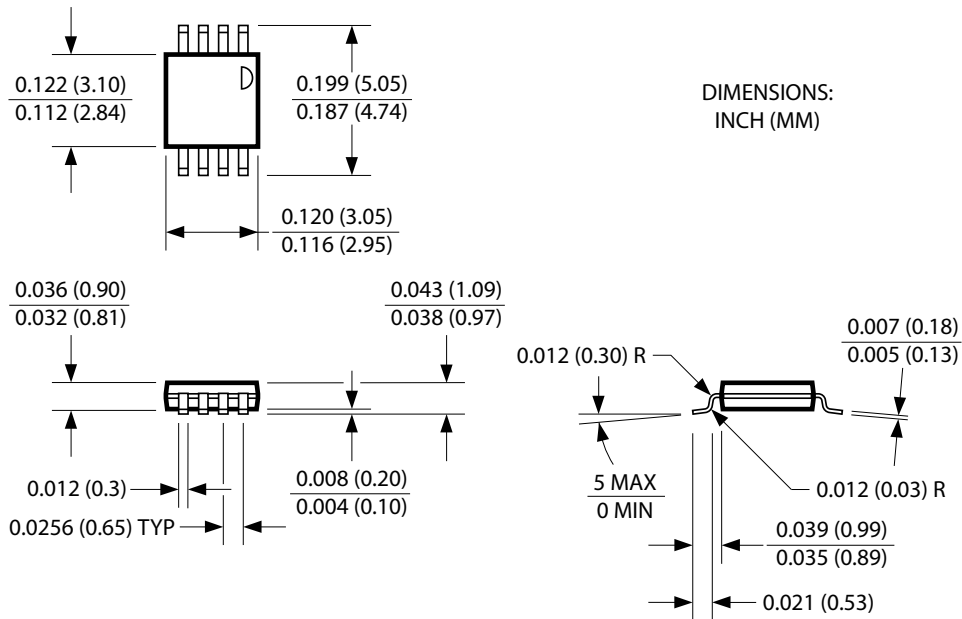

Figure 9.  $V_{DD}$  Decoupling for Very Noisy Supplies

# Package Information



**8-Lead SOIC (M)**



**8-Lead MSOP (MM)**

---

**MICREL INC. 2180 FORTUNE DRIVE SAN JOSE, CA 95131 USA**  
TEL + 1 (408) 944-0800 FAX + 1 (408) 474-1000 WEB <http://www.micrel.com>

This information furnished by

Micrel reserves the right to change circuitry and specifications at any time without notification to the customer.

Micrel Products are not

reasonably be expected to result in personal injury. Life support devices or systems are devices or systems that (a) are intended for surgical implant into the body or (b) support or sustain life, and whose failure to perform can be reasonably expected to result in a significant injury to the user. A Purchaser's use or sale of Micrel Pr

Micrel for any damages resulting from such use or sale.

© 2005 Micrel Incorporated