

30V Input, 1A Output, High-Efficiency, Integrated Synchronous Switch Step-Down Regulator

Features

- Up to 95% Efficiency
- Input Voltage Range: 4.4V to 30V
- 1A Output Current Capability
- Output Voltage Range: 2.0V to 24V
- Qualification: AEC-Q100 Rev. G, Grade 1 (-40°C to +125°C)
- Integrated N-Channel High-Side and Low-Side Switches:
 - 170 mΩ, Low Side
 - 300 mΩ, High Side
- Stable Reference Voltage: 0.8V
- Automatic Pulse Frequency Modulation/Pulse-Width Modulation (PFM/PWM) Operation (**MCP16311**):
 - PFM Operation Disabled (**MCP16312**)
 - PWM Operation: 500 kHz
- Low Device Shutdown Current: 3 μA Typical
- Low Device Quiescent Current:
 - 44 μA (Non-switching, PFM Mode)
- Internal Compensation
- Internal Soft-Start: 300 μs (EN Low-to-High)
- Peak Current Mode Control
- Cycle-by-Cycle Peak Current Limit
- Undervoltage Lockout (UVLO):
 - 4.1V typical to start
 - 3.6V typical to stop
- Overtemperature Protection
- Thermal Shutdown:
 - +150°C
 - +25°C Hysteresis

Applications

- PIC®/dsPIC® Microcontroller Bias Supply
- 24V Industrial Input DC-DC Conversion
- General Purpose DC-DC Conversion
- Local Point of Load Regulation
- Automotive Battery Regulation
- Set-Top Boxes
- Cable Modems
- Wall Transformer Regulation
- Laptop Computers
- Networking Systems
- AC-DC Digital Control Bias
- Distributed Power Supplies

General Description

The MCP16311/2 is a compact, high-efficiency, fixed frequency, synchronous step-down DC-DC converter in an 8-pin MSOP, or 2 x 3 mm TDFN package that operates from input voltage sources up to 30V. Integrated features include a high-side and a low-side switch, fixed frequency peak current mode control, internal compensation, peak current limit and overtemperature protection. The MCP16311/2 provides all the active functions for local DC-DC conversion, with fast transient response and accurate regulation.

High converter efficiency is achieved by integrating the current-limited, low-resistance, high-speed high-side and low-side switches and associated drive circuitry. The MCP16311 is capable of running in PWM/PFM mode. It switches in PFM mode for light load conditions and for large buck conversion ratios. This results in a higher efficiency over all load ranges. The MCP16312 runs in PWM-only mode, and is recommended for noise-sensitive applications.

The MCP16311/2 can supply up to 1A of continuous current while regulating the output voltage from 2V to 12V. An integrated, high-performance peak current mode architecture keeps the output voltage tightly regulated, even during input voltage steps and output current transient conditions common in power systems.

The EN input is used to turn the device on and off. While off, only a few micro amps of current are consumed from the input.

Output voltage is set with an external resistor divider. The MCP16311/2 is offered in small MSOP-8 and 2 x 3 mm TDFN surface mount packages.

Package Type

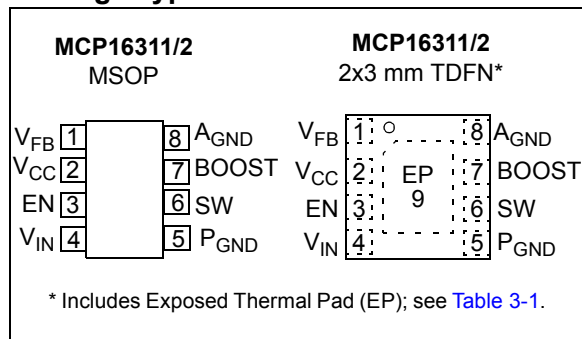

MCP16311/2

Typical Applications

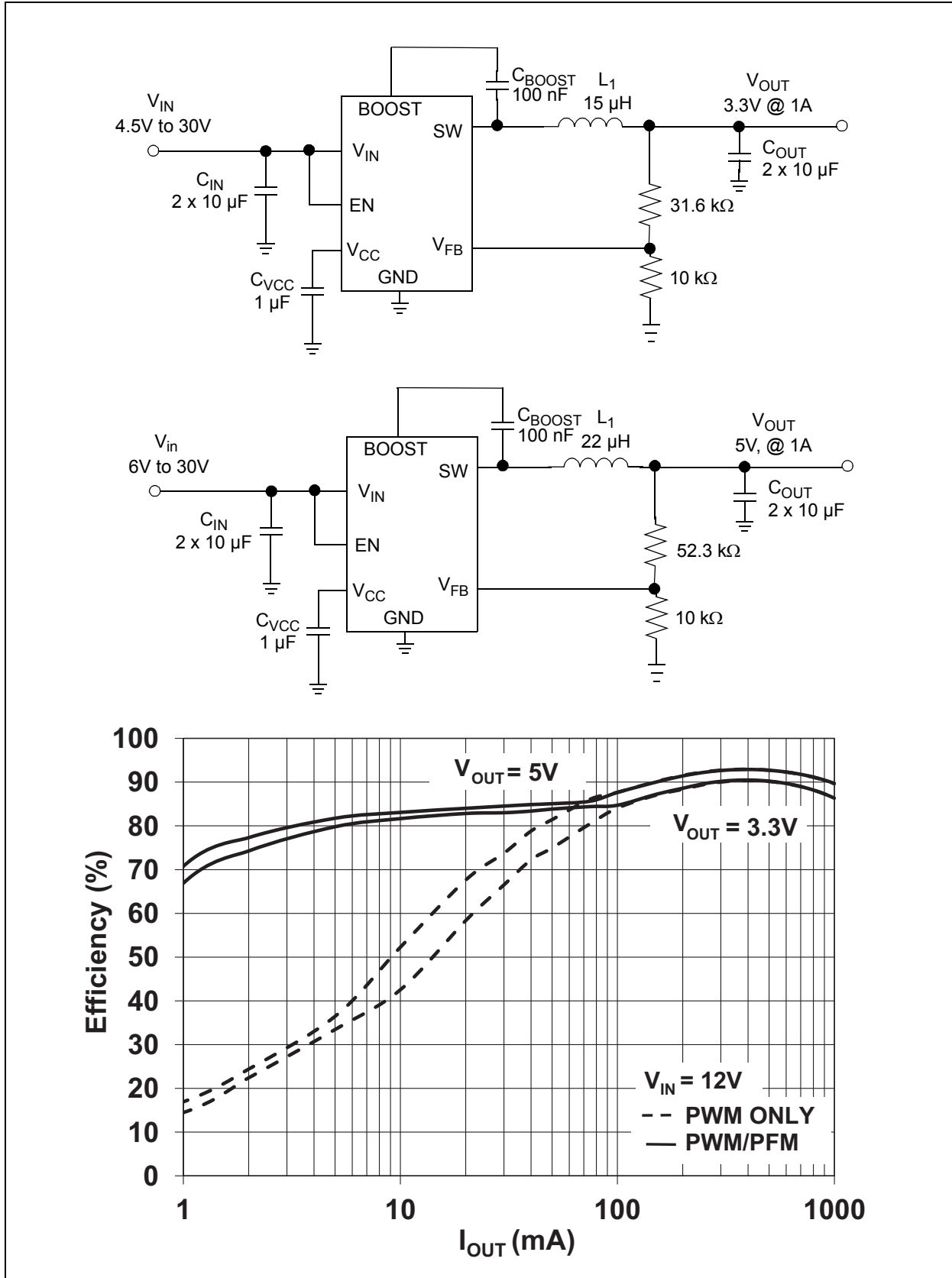

1.0 ELECTRICAL CHARACTERISTICS

Absolute Maximum Ratings †

$V_{IN, SW}$	-0.5V to 32V
BOOST – GND	-0.5V to 38V
BOOST – SW Voltage.....	-0.5V to 6.0V
V_{FB} Voltage	-0.5V to 6.0V
EN Voltage	-0.5V to ($V_{IN} + 0.3V$)
Output Short-Circuit Current	Continuous
Power Dissipation	Internally Limited
Storage Temperature	-65°C to +150°C
Ambient Temperature with Power Applied	-40°C to +125°C
Operating Junction Temperature.....	-40°C to +150°C
ESD Protection on All Pins:	
HBM	1 kV
MM	200V

† **Notice:** Stresses above those listed under “Maximum Ratings” may cause permanent damage to the device. This is a stress rating only and functional operation of the device at those or any other conditions above those indicated in the operational sections of this specification is not intended. Exposure to maximum rating conditions for extended periods may affect device reliability.

DC CHARACTERISTICS

Electrical Characteristics: Unless otherwise indicated, $T_A = +25^\circ\text{C}$, $V_{IN} = V_{EN} = 7V$, $V_{BOOST} - V_{SW} = 5.0V$, $V_{OUT} = 5.0V$, $I_{OUT} = 100\text{ mA}$, $L = 22\ \mu\text{H}$, $C_{OUT} = C_{IN} = 2 \times 10\ \mu\text{F}$ X7R Ceramic Capacitors.
Boldface specifications apply over the T_A range of -40°C to $+125^\circ\text{C}$.

Parameters	Sym.	Min.	Typ.	Max.	Units	Conditions
V_{IN} Supply Voltage						
Input Voltage	V_{IN}	4.4	—	30	V	Note 1
Quiescent Current	I_Q	—	44	60	μA	Nonswitching, $V_{FB} = 0.9V$
Quiescent Current - PFM Mode	I_{Q_PFM}	—	85	—	μA	Switching, $I_{OUT} = 0$ (MCP16311)
Quiescent Current - PWM Mode	I_{Q_PWM}	—	3.8	8	mA	Switching, $I_{OUT} = 0$ (MCP16312)
Quiescent Current - Shutdown	I_{Q_SHDN}	—	3	9	μA	$V_{OUT} = EN = 0V$
V_{IN} Undervoltage Lockout						
Undervoltage Lockout Start	$UVLO_{STRT}$	—	4.1	4.4	V	V_{IN} Rising
Undervoltage Lockout Stop	$UVLO_{STOP}$	3.18	3.6	—	V	V_{IN} Falling
Undervoltage Lockout Hysteresis	$UVLO_{HYS}$	0.2	0.5	1	V	
Output Characteristics						
Feedback Voltage	V_{FB}	0.784	0.800	0.816	V	$I_{OUT} = 5\text{ mA}$
Output Voltage Adjust Range	V_{OUT}	2.0	—	24	V	Note 2, Note 3
Feedback Voltage Line Regulation	$(\Delta V_{FB}/V_{FB})/\Delta V_{IN}$	-0.15	0.01	0.15	%/V	$V_{IN} = 7V$ to $30V$, $I_{OUT} = 50\text{ mA}$
Feedback Voltage Load Regulation	$ \Delta V_{FB} / V_{FB} $	—	0.25	—	%	$I_{OUT} = 5\text{ mA}$ to $1A$, MCP16312

Note 1: The input voltage should be greater than the output voltage plus headroom voltage; higher load currents increase the input voltage necessary for regulation. See characterization graphs for typical input-to-output operating voltage range.

2: For $V_{IN} < V_{OUT}$, V_{OUT} will not remain in regulation; for output voltages above 12V, the maximum current will be limited to under 1A.

3: Determined by characterization, not production tested.

4: This is ensured by design.

MCP16311/2

DC CHARACTERISTICS (CONTINUED)

Electrical Characteristics: Unless otherwise indicated, $T_A = +25^\circ\text{C}$, $V_{IN} = V_{EN} = 7\text{V}$, $V_{BOOST} - V_{SW} = 5.0\text{V}$, $V_{OUT} = 5.0\text{V}$, $I_{OUT} = 100\text{ mA}$, $L = 22\ \mu\text{H}$, $C_{OUT} = C_{IN} = 2 \times 10\ \mu\text{F X7R Ceramic Capacitors}$.
Boldface specifications apply over the T_A range of -40°C to $+125^\circ\text{C}$.

Parameters	Sym.	Min.	Typ.	Max.	Units	Conditions
Feedback Input Bias Current	I_{FB}	—	10	250	nA	
Output Current	I_{OUT}	1	—	—	A	Notes 1 to 3, Figure 2-7
Switching Characteristics						
Switching Frequency	f_{SW}	425	500	575	kHz	
Maximum Duty Cycle	DC_{MAX}	85	94	—	%	Note 3
Minimum Duty Cycle	DC_{MIN}	—	2	—	%	Note 4
High-Side NMOS Switch-On Resistance	$R_{DS(ON)}$	—	0.3	—	Ω	$V_{BOOST} - V_{SW} = 5\text{V}$, Note 3
Buck NMOS Switch Current Limit	$I_{(MAX)}$	—	1.8	—	A	$V_{BOOST} - V_{SW} = 5\text{V}$, Note 3
Synchronous NMOS Switch-On Resistance	$R_{DS(ON)}$	—	0.17	—	Ω	Note 3
EN Input Characteristics						
EN Input Logic High	V_{IH}	1.85	—	—	V	
EN Input Logic Low	V_{IL}	—	—	0.4	V	
EN Input Leakage Current	I_{ENLK}	—	0.1	1	μA	$V_{EN} = 5\text{V}$
Soft-Start Time	t_{SS}	—	300	—	μs	EN Low-to-High, 90% of V_{OUT}
Thermal Characteristics						
Thermal Shutdown Die Temperature	T_{SD}	—	150	—	$^\circ\text{C}$	Note 3
Die Temperature Hysteresis	T_{SDHYS}	—	25	—	$^\circ\text{C}$	Note 3

- Note 1:** The input voltage should be greater than the output voltage plus headroom voltage; higher load currents increase the input voltage necessary for regulation. See characterization graphs for typical input-to-output operating voltage range.
- 2:** For $V_{IN} < V_{OUT}$, V_{OUT} will not remain in regulation; for output voltages above 12V, the maximum current will be limited to under 1A.
- 3:** Determined by characterization, not production tested.
- 4:** This is ensured by design.

TEMPERATURE CHARACTERISTICS

Electrical Specifications: Unless otherwise indicated, $T_A = +25^\circ\text{C}$, $V_{IN} = V_{EN} = 7\text{V}$, $V_{BOOST} - V_{SW} = 5.0\text{V}$, $V_{OUT} = 5.0\text{V}$.

Parameters	Sym.	Min.	Typ.	Max.	Units	Conditions
Temperature Ranges						
Operating Junction Temperature Range	T_J	-40	—	+125	$^\circ\text{C}$	Steady State
Storage Temperature Range	T_A	-65	—	+150	$^\circ\text{C}$	
Maximum Junction Temperature	T_J	—	—	+150	$^\circ\text{C}$	Transient
Package Thermal Resistances						
Thermal Resistance, 8L-MSOP	θ_{JA}	—	211	—	$^\circ\text{C/W}$	EIA/JESD51-3 Standard
Thermal Resistance, 8L-2x3 TDFN	θ_{JA}	—	52.5	—	$^\circ\text{C/W}$	EIA/JESD51-3 Standard

2.0 TYPICAL PERFORMANCE CURVES

Note: The graphs and tables provided following this note are a statistical summary based on a limited number of samples and are provided for informational purposes only. The performance characteristics listed herein are not tested or guaranteed. In some graphs or tables, the data presented may be outside the specified operating range (e.g., outside specified power supply range) and therefore outside the warranted range.

Note: Unless otherwise indicated, $V_{IN} = EN = 7V$, $C_{OUT} = C_{IN} = 2 \times 10 \mu F$, $L = 22 \mu H$, $V_{OUT} = 5.0V$, $I_{LOAD} = 100 \text{ mA}$, $T_A = +25^\circ C$, 8L-MSOP package.

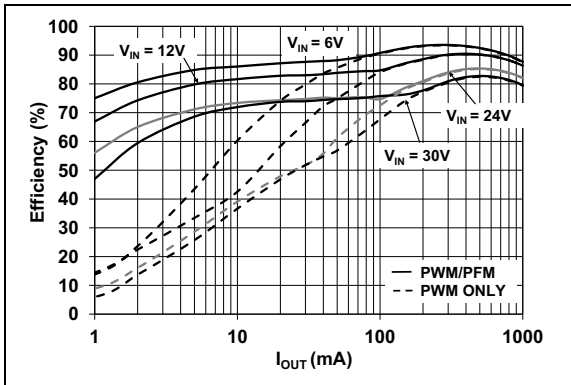

FIGURE 2-1: 3.3V V_{OUT} Efficiency vs. I_{OUT}

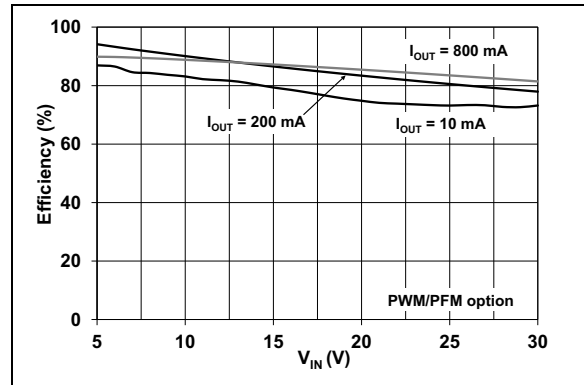

FIGURE 2-4: 3.3V V_{OUT} Efficiency vs. V_{IN}

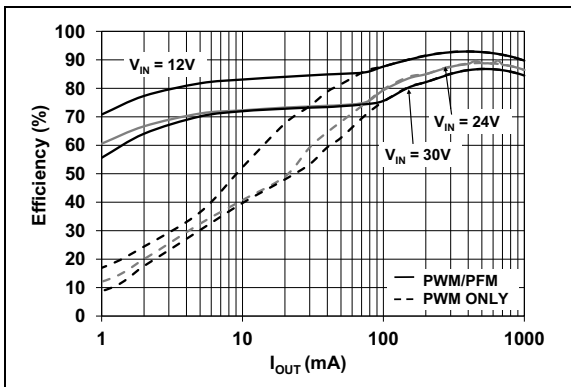

FIGURE 2-2: 5.0V V_{OUT} Efficiency vs. I_{OUT}

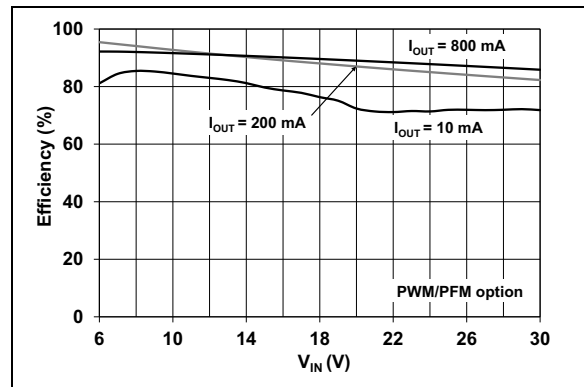

FIGURE 2-5: 5.0V V_{OUT} Efficiency vs. V_{IN}

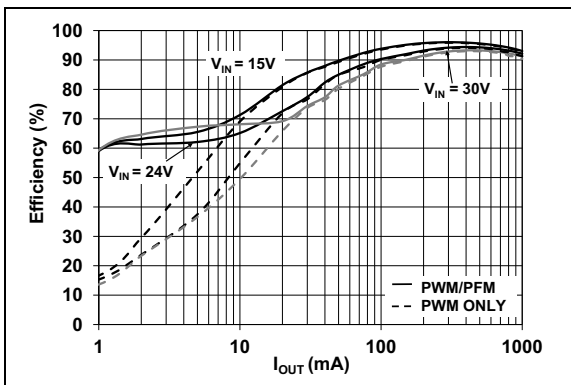

FIGURE 2-3: 12.0V V_{OUT} Efficiency vs. I_{OUT}

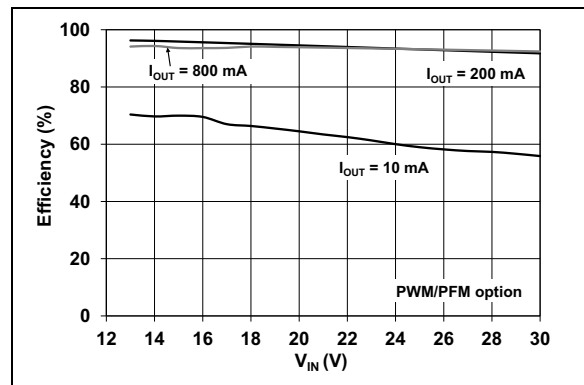

FIGURE 2-6: 12.0V V_{OUT} Efficiency vs. V_{IN}

MCP16311/2

Note: Unless otherwise indicated, $V_{IN} = EN = 7V$, $C_{OUT} = C_{IN} = 2 \times 10 \mu F$, $L = 22 \mu H$, $V_{OUT} = 5.0V$, $I_{LOAD} = 100 \text{ mA}$, $T_A = +25^\circ C$, 8L-MSOP package.

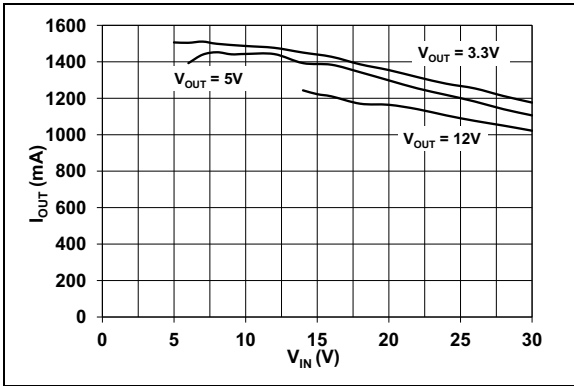

FIGURE 2-7: Max I_{OUT} vs. V_{IN} .

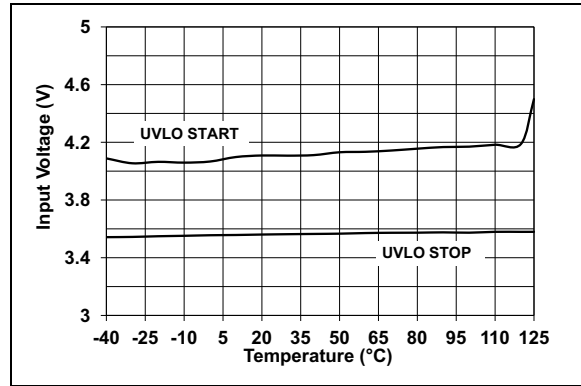

FIGURE 2-10: Undervoltage Lockout vs. Temperature.

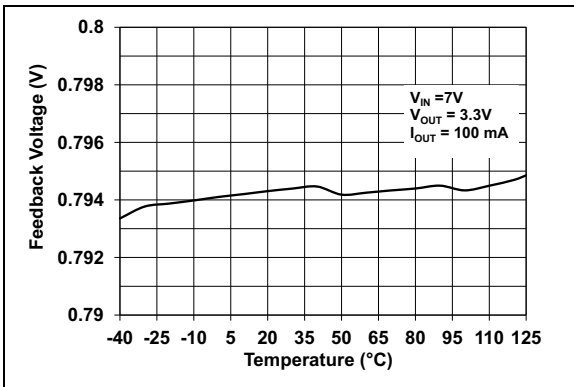

FIGURE 2-8: V_{FB} vs. Temperature; $V_{OUT} = 3.3V$.

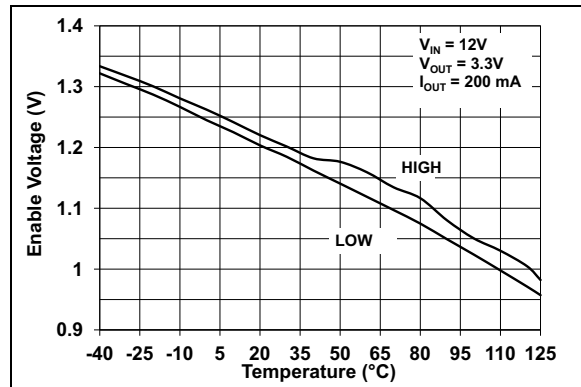

FIGURE 2-11: Enable Threshold Voltage vs. Temperature.

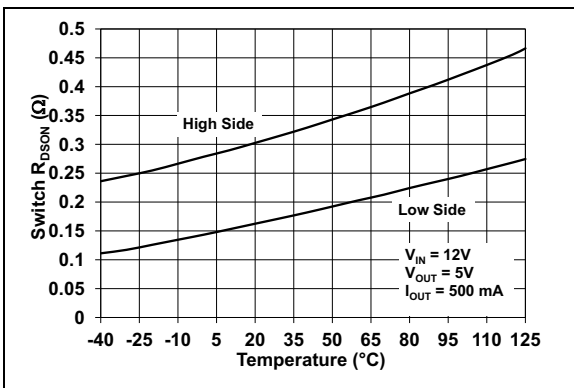

FIGURE 2-9: Switch $R_{DS(on)}$ vs. Temperature.

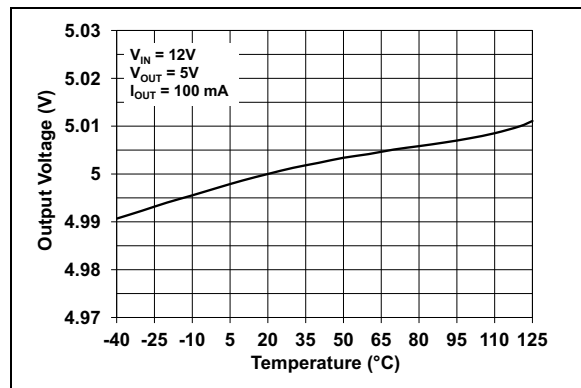

FIGURE 2-12: V_{OUT} vs. Temperature.

Note: Unless otherwise indicated, $V_{IN} = EN = 7V$, $C_{OUT} = C_{IN} = 2 \times 10 \mu F$, $L = 22 \mu H$, $V_{OUT} = 5.0V$, $I_{LOAD} = 100 \text{ mA}$, $T_A = +25^\circ C$, 8L-MSOP package.

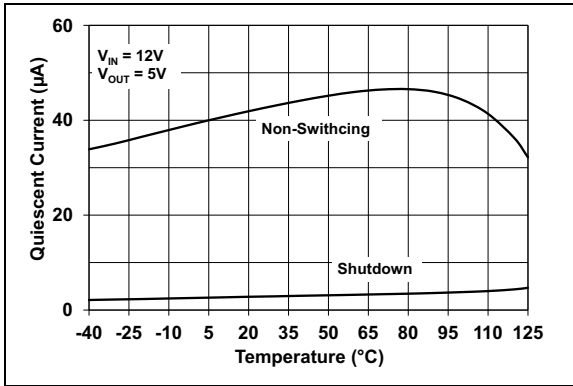

FIGURE 2-13: Input Quiescent Current vs. Temperature.

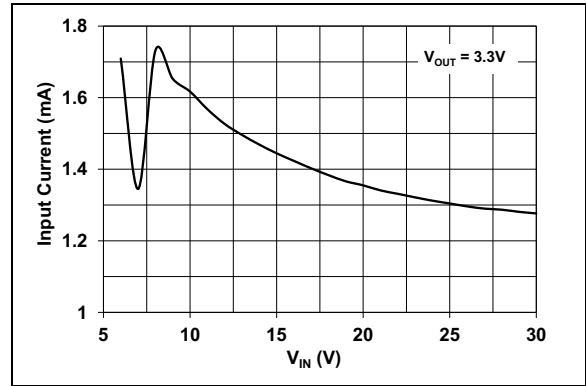

FIGURE 2-16: PWM No Load Input Current vs. V_{IN} , MCP16312.

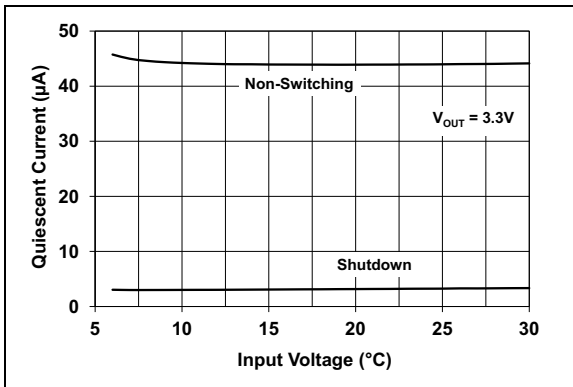

FIGURE 2-14: Input Quiescent Current vs. Input Voltage.

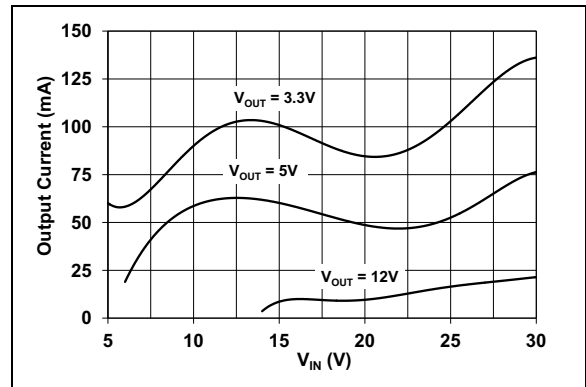

FIGURE 2-17: PFM/PWM I_{OUT} Threshold vs. V_{IN} .

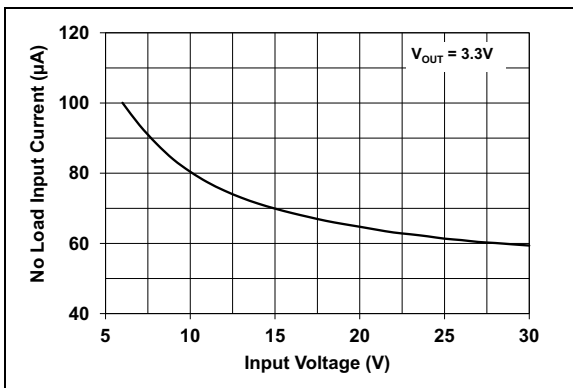

FIGURE 2-15: PFM No Load Input Current vs. Input Voltage, MCP16311.

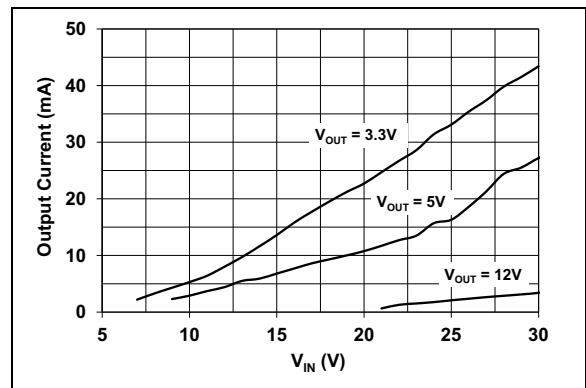

FIGURE 2-18: Skipping/PWM I_{OUT} Threshold vs. Input Voltage.

MCP16311/2

Note: Unless otherwise indicated, $V_{IN} = EN = 7V$, $C_{OUT} = C_{IN} = 2 \times 10 \mu F$, $L = 22 \mu H$, $V_{OUT} = 5.0V$, $I_{LOAD} = 100 \text{ mA}$, $T_A = +25^\circ C$, 8L-MSOP package.

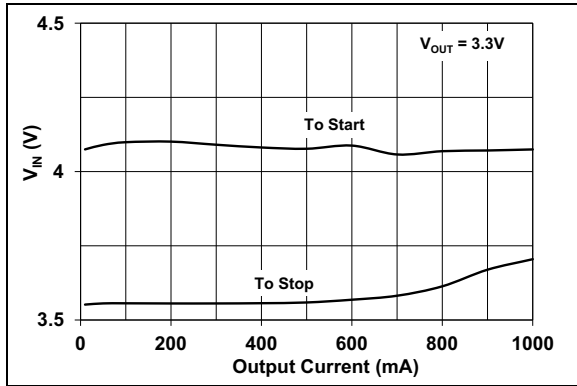

FIGURE 2-19: Typical Minimum Input Voltage vs. Output Current.

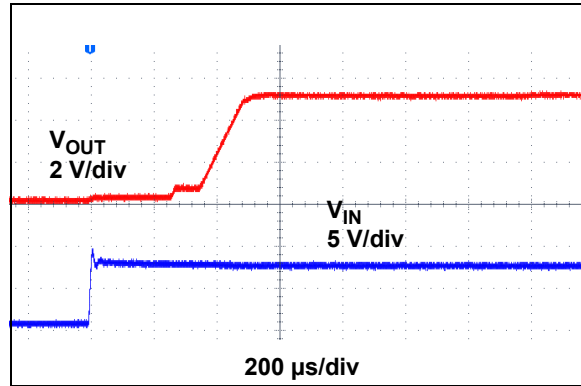

FIGURE 2-22: Start-Up From V_{IN} .

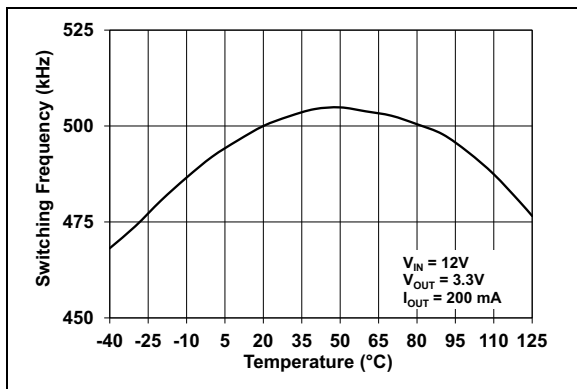

FIGURE 2-20: Switching Frequency vs. Temperature.

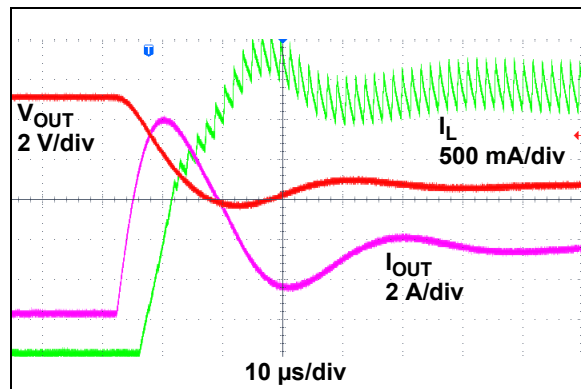

FIGURE 2-23: Short-Circuit Response.

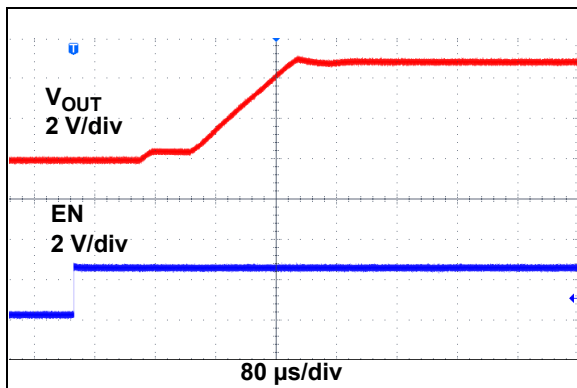

FIGURE 2-21: Start-Up From Enable.

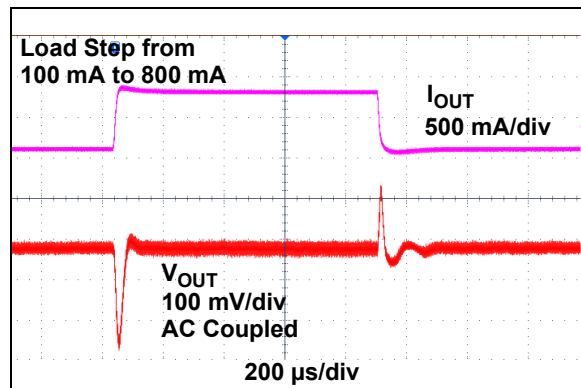

FIGURE 2-24: Load Transient Response.

Note: Unless otherwise indicated, $V_{IN} = EN = 7V$, $C_{OUT} = C_{IN} = 2 \times 10 \mu F$, $L = 22 \mu H$, $V_{OUT} = 5.0V$, $I_{LOAD} = 100 \text{ mA}$, $T_A = +25^\circ C$, 8L-MSOP package.

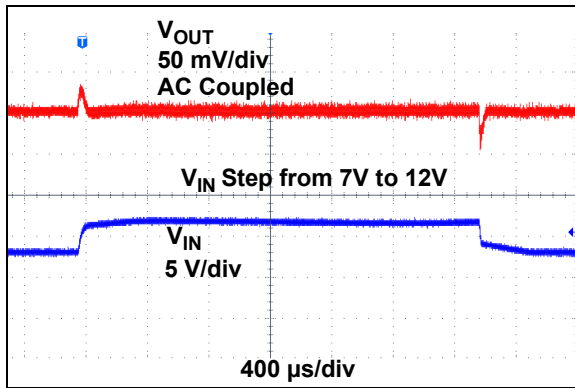

FIGURE 2-25: Line Transient Response.

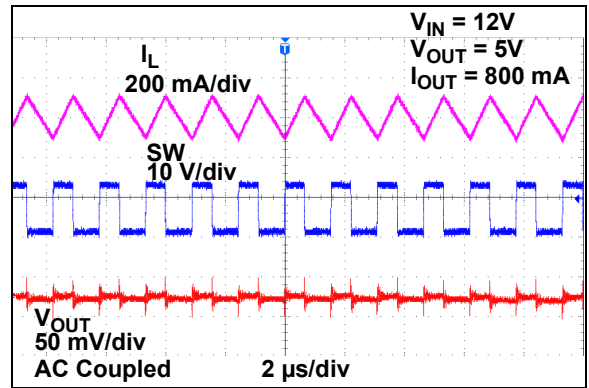

FIGURE 2-28: Heavy Load Switching Waveforms.

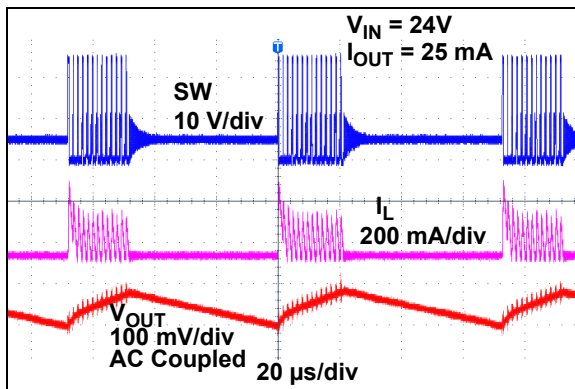

FIGURE 2-26: PFM Light Load Switching Waveforms.

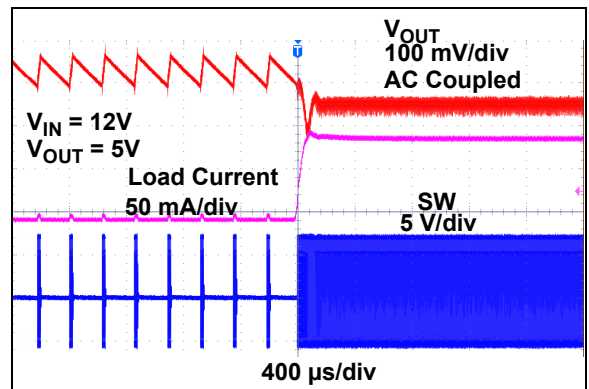

FIGURE 2-29: PFM to PWM Transition; Load Step from 5 mA to 100 mA.

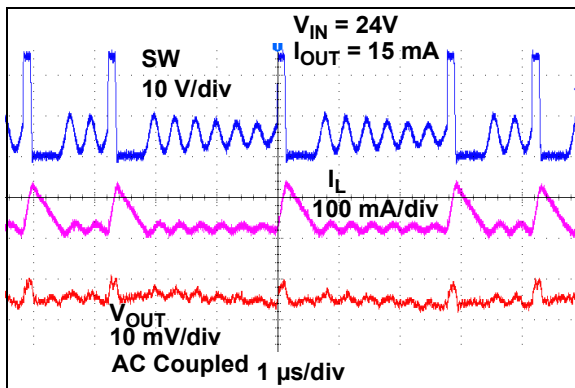

FIGURE 2-27: PWM Light Load Switching Waveforms.

MCP16311/2

NOTES:

3.0 PIN DESCRIPTIONS

The descriptions of the pins are listed in [Table 3-1](#).

TABLE 3-1: PIN FUNCTION TABLE

MCP16311/2 2 x 3 TDFN	MCP16311/2 MSOP	Symbol	Description
1	1	V_{FB}	Output Voltage Feedback pin. Connect V_{FB} to an external resistor divider to set the output voltage.
2	2	V_{CC}	Internal Regulator Output pin. Bypass Capacitor is required on this pin to provide high peak current for gate drive.
3	3	EN	Enable pin. Logic high enables the operation. Do not allow this pin to float.
4	4	V_{IN}	Input Supply Voltage pin for power and internal biasing
5	5	P_{GND}	Power Ground pin
6	6	SW	Output Switch Node pin, connects to the inductor and the bootstrap capacitor
7	7	BOOST	Boost Voltage pin that supplies the driver used to control the high-side NMOS switch. A bootstrap capacitor is connected between the BOOST and SW pins.
8	8	A_{GND}	Signal Ground pin
9	—	EP	Exposed thermal pad

3.1 Feedback Voltage Pin (V_{FB})

The V_{FB} pin is used to provide output voltage regulation by using a resistor divider. The V_{FB} voltage will be 0.800V typical with the output voltage in regulation.

3.2 Internal Bias Pin (V_{CC})

The V_{CC} internal bias is derived from the input voltage V_{IN} . V_{CC} is set to 5.0V typical. The V_{CC} is used to provide a stable low bias voltage for the upper and lower gate drive circuits. This output should be decoupled to A_{GND} with a 1 μ F capacitor, X7R. This capacitor should be connected as close as possible to the V_{CC} and A_{GND} pin.

3.3 Enable Pin (EN)

The EN pin is a logic-level input used to enable or disable the device and lower the quiescent current while disabled. A logic high (> 1.3V) will enable the regulator output. A logic low (< 1V) will ensure that the regulator is disabled.

3.4 Power Supply Input Voltage Pin (V_{IN})

Connect the input voltage source to V_{IN} . The input source should be decoupled to GND with a 4.7 μ F-20 μ F capacitor, depending on the impedance of the source and output current. The input capacitor provides current for the switch node and a stable voltage source for the internal device power. This capacitor should be connected as close as possible to the V_{IN} and GND pins. For light-load applications, a 2.2 μ F X7R or X5R ceramic capacitor can be used.

3.5 Analog Ground Pin (A_{GND})

This ground is used by most internal circuits, such as the analog reference, control loop and other circuits.

3.6 Power Ground Pin (P_{GND})

This is a separate ground connection used for the low-side synchronous switch. The length of the trace from the input cap return, output cap return and GND pin should be made as short as possible to minimize the noise in the system. The power ground and the analog ground should be connected in a single point.

3.7 Switch Node Pin (SW)

The switch node pin is connected internally to the low-side and high-side switch, and externally to the SW node, consisting of the inductor and boost capacitor. The SW node can rise very fast as a result of the internal switch turning on.

3.8 Boost Pin (BOOST)

The high side of the floating supply used to turn the integrated N-Channel high-side MOSFET on and off is connected to the boost pin.

3.9 Exposed Thermal Pad Pin (EP)

There is an internal electrical connection between the EP and the P_{GND} and A_{GND} pins.

MCP16311/2

NOTES:

4.0 DETAILED DESCRIPTION

4.1 Device Overview

The MCP16311/2 is a high input voltage step-down regulator, capable of supplying 1A typical to a regulated output voltage from 2.0V to 12V. Internally, the trimmed 500 kHz oscillator provides a fixed frequency, while the peak current mode control architecture varies the duty cycle for output voltage regulation. An internal floating driver is used to turn the high-side integrated N-Channel MOSFET on and off. The power for this driver is derived from an external boost capacitor whose energy is replenished when the low-side N-Channel MOSFET is turned on.

4.1.1 PWM/PFM MODE OPTION

The MCP16311 selects the best operating switching mode (PFM or PWM) for high efficiency across a wide range of load currents. Switching to PFM mode at light-load currents results in a low quiescent current. During the sleep period (between two packets of switching cycles), the MCP16311 draws 44 μ A (typical) from the supply line. The switching pulse packets represent a small percentage of the total running cycle, and the overall average current drawn from power line is small.

The disadvantages of PWM/PFM mode are higher output ripple voltage and variable PFM mode frequency. The PFM mode threshold is a function of the input voltage, output voltage and load (see [Figure 2-17](#)).

4.1.2 PWM-ONLY MODE OPTION

In the MCP16312 devices, the PFM mode is disabled and the part runs only in PWM over the entire load range. During normal operation, the MCP16312 continues to operate at a constant 500 kHz switching frequency, keeping the output ripple voltage lower than in PFM mode. At lighter loads, the MCP16312 devices begin to skip pulses. [Figure 2-18](#) represents the input voltage versus load current for the pulse skipping threshold in PWM-only mode.

Because the MCP16312 has very low output voltage ripple, it is recommended for noise-sensitive applications.

TABLE 4-1: PART NUMBER SELECTION

Part Number	PWM/PFM	PWM
MCP16311	✓	—
MCP16312	—	✓

4.1.3 INTERNAL REFERENCE VOLTAGE (V_{FB})

An integrated precise 0.8V reference combined with an external resistor divider sets the desired converter output voltage. The resistor divider range can vary without affecting the control system gain. High-value resistors consume less current, but are more susceptible to noise. Consult typical applications for the recommended resistors value.

4.1.4 INTERNAL BIAS REGULATOR (V_{CC})

An internal Low Dropout Voltage Regulator (LDO) is used to supply 5.0V to all the internal circuits. The LDO regulates the input voltage (V_{IN}) and can supply enough current (up to 50 mA) to sustain the drivers and internal bias circuitry. The V_{CC} pin must be decoupled to ground with a 1 μ F capacitor. In the event of a thermal shut down, the LDO will shut down. There is a short-circuit protection for the V_{CC} pin, with a threshold set at 150 mA.

In PFM switching mode, during sleep periods, the V_{CC} regulator enters Low Quiescent Current mode to avoid unnecessary power dissipation.

Avoid driving any external load using the V_{CC} pin.

4.1.5 INTERNAL COMPENSATION

All control system components necessary for stable operation over the entire device operating range are integrated, including the error amplifier and inductor current slope compensation. To add the proper amount of slope compensation, the inductor value changes along with the output voltage (see [Table 5-1](#)).

4.1.6 EXTERNAL COMPONENTS

External components consist of:

- Input capacitor
- Output filter (inductor and capacitor)
- Boost capacitor
- Resistor divider

The selection of the external inductor, output capacitor and input capacitor is dependent upon the output voltage and the maximum output current.

4.1.7 ENABLE INPUT

The enable input (EN) is used to disable the device. If disabled, the device consumes a minimum current from the input. Once enabled, the internal soft start controls the output voltage rate of rise, preventing high-inrush current and output voltage overshoot.

There is no internal pull-up or pull-down resistor. To enable the converter, the EN pin must be pulled high. To disable the converter, the EN pin must be pulled low.

MCP16311/2

4.1.8 SOFT START

The internal reference voltage rate of rise is controlled during start-up, minimizing the output voltage overshoot and the inrush current.

4.1.9 UNDERVOLTAGE LOCKOUT

An integrated Undervoltage Lockout (UVLO) prevents the converter from starting until the input voltage is high enough for normal operation. The converter will typically start at 4.1V and operate down to 3.6V. Hysteresis is added to prevent starting and stopping during start-up as a result of loading the input voltage source.

4.1.10 OVERTEMPERATURE PROTECTION

Overtemperature protection limits the silicon die temperature to +150°C by turning the converter off. The normal switching resumes at +125°C.

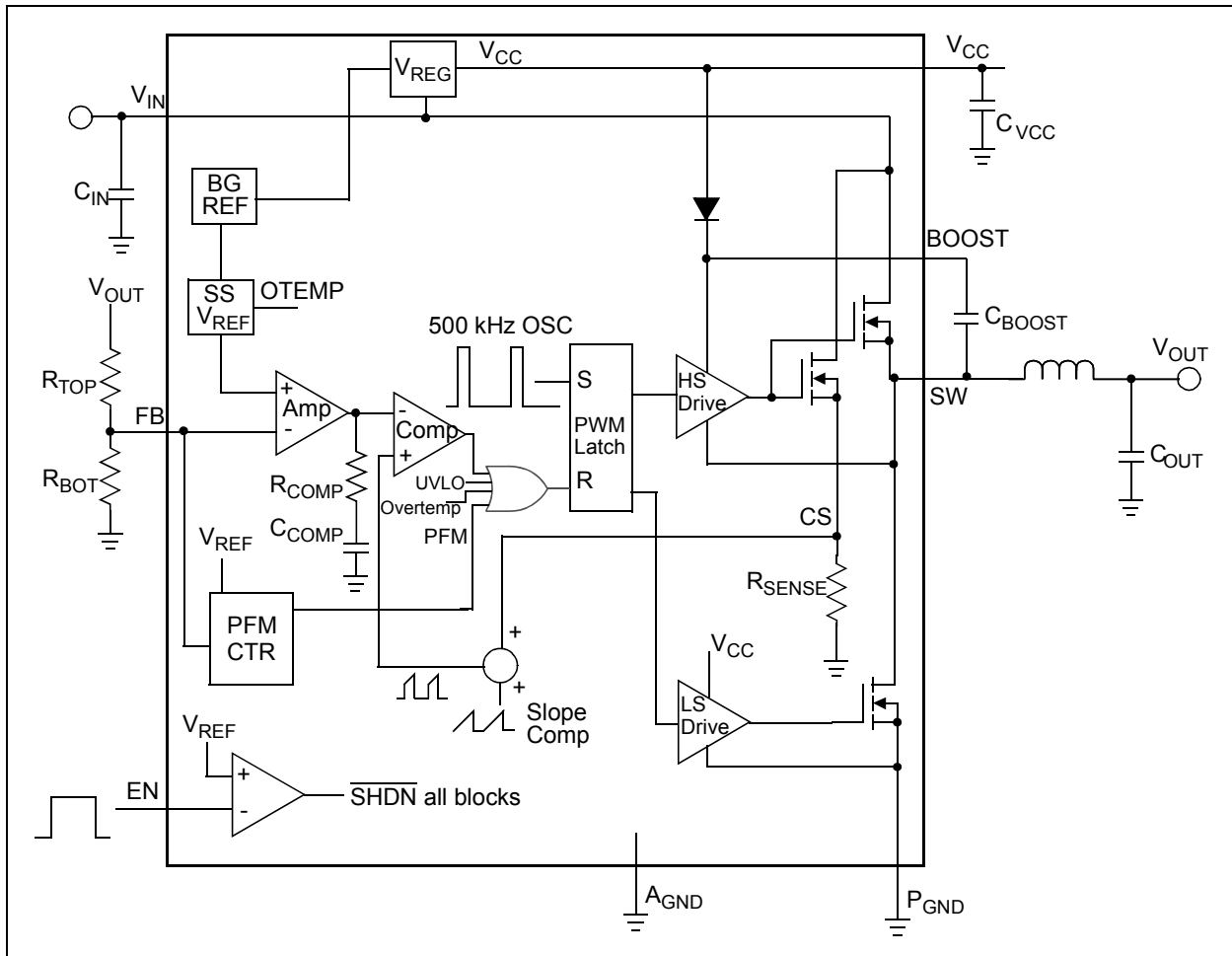

FIGURE 4-1: MCP16311/2 Block Diagram.

4.2 Functional Description

4.2.1 STEP-DOWN OR BUCK CONVERTER

The MCP16311/2 is a synchronous step-down or buck converter capable of stepping input voltages ranging from 4.4V to 30V down to 2.0V to 24V for $V_{IN} > V_{OUT}$.

The integrated high-side switch is used to chop or modulate the input voltage using a controlled duty cycle. The integrated low-side switch is used to freewheel current when the high-side switch is turned off. High efficiency is achieved by using low-resistance switches and low equivalent series resistance (ESR) inductors and capacitors. When the high-side switch is turned on, a DC voltage is applied to the inductor ($V_{IN} - V_{OUT}$), resulting in a positive linear ramp of inductor current. When the high-side switch turns off and the low-side switch turns on, the applied inductor voltage is equal to $-V_{OUT}$, resulting in a negative linear ramp of inductor current. In order to ensure there is no shoot-through current, a dead time where both switches are off is implemented between the high-side switch turning off and the low-side switch turning on, and the low-side switch turning off and the high-side switch turning on.

For steady-state, continuous inductor current operation, the positive inductor current ramp must equal the negative current ramp in magnitude. While operating in steady state, the switch duty cycle must be equal to the relationship of V_{OUT}/V_{IN} for constant output voltage regulation, under the condition that the inductor current is continuous or never reaches zero. For discontinuous inductor current operation, the steady-state duty cycle will be less than V_{OUT}/V_{IN} to maintain voltage regulation. When the inductor current reaches zero, the low-side switch is turned off so that current does not flow in the reverse direction, keeping the efficiency high. The average of the chopped input voltage or SW node voltage is equal to the output voltage, while the average inductor current is equal to the output current.

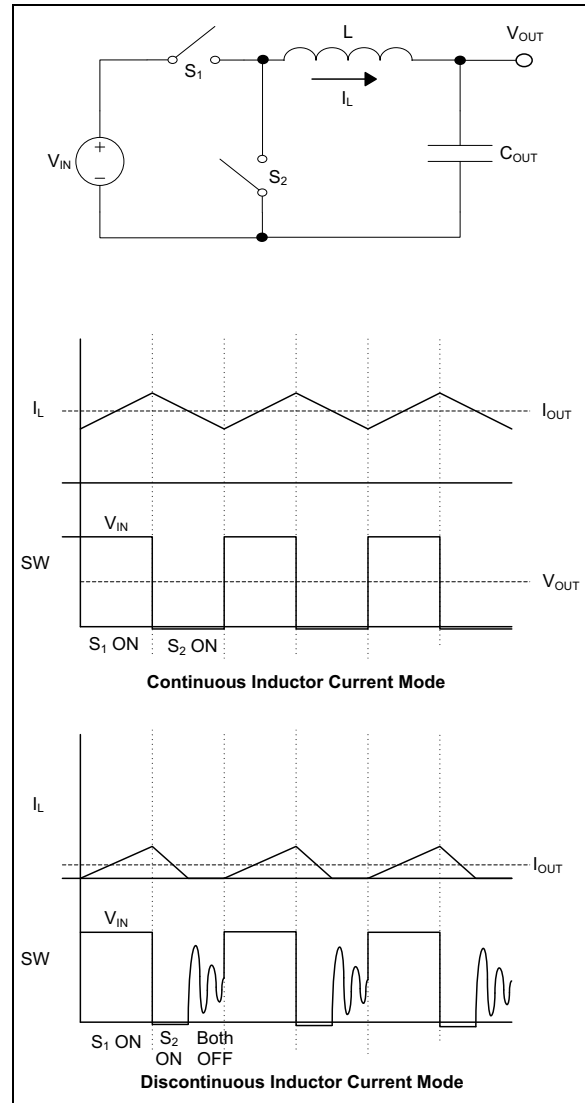

FIGURE 4-2: Synchronous Step-Down Converter.

MCP16311/2

4.2.2 PEAK CURRENT MODE CONTROL

The MCP16311/2 integrates a peak current mode control architecture, resulting in superior AC regulation while minimizing the number and size of voltage loop compensation components for integration. Peak current mode control takes a small portion of the inductor current, replicates it, and compares this replicated current sense signal with the error voltage. In practice, the inductor current and the internal switch current are equal during the switch-on time. By adding this peak current sense to the system control, the step-down power train system can be approximated by a first order system rather than a second order system. This reduces the system complexity and increases its dynamic performance.

For Pulse-Width Modulation (PWM) duty cycles that exceed 50%, the control system can become bimodal, where a wide pulse followed by a short pulse repeats instead of the desired fixed pulse width. To prevent this mode of operation, an internal compensating ramp is summed into the current sense signal.

4.2.3 PULSE-WIDTH MODULATION

The internal oscillator periodically starts the switching period, which in the MCP16311/2's case occurs every 2 μ s or 500 kHz. With the high-side integrated N-Channel MOSFET turned on, the inductor current ramps up until the sum of the current sense and slope compensation ramp exceeds the integrated error amplifier output. Once this occurs, the high-side switch turns off and the low-side switch turns on. The error amplifier output slews up or down to increase or decrease the inductor peak current feeding into the output LC filter. If the regulated output voltage is lower than its target, the inverting error amplifier output rises. This results in an increase in the inductor current to correct for errors in the output voltage. The fixed frequency duty cycle is terminated when the sensed inductor peak current, summed with the internal slope compensation, exceeds the output voltage of the error amplifier. The PWM latch is set by turning off the high-side internal switch and preventing it from turning on until the beginning of the next cycle.

The MCP16312 devices will operate in PWM-only mode even during periods of light load operation. By operating in PWM-only mode, the output ripple remains low and the frequency is constant (Figure 2-28). Operating in fixed PWM mode results in lower efficiency during light-load operation (when compared to PFM mode (MCP16311)).

When working close to the boundary conduction threshold, a jitter on the SW node may occur, reflecting in the output voltage. Although the low-frequency output component is very small, it may be desirable to completely eliminate this component. To achieve this, an RC Snubber between the SW node and GND is used.

Typical values for the snubber are: 680 pF and 430 Ω . Using such a snubber completely eliminates the jitter on the SW node, but slightly decreases the overall efficiency of the converter.

4.2.4 PFM MODE OPERATION

The MCP16311 devices are capable of automatic operation in normal PWM or PFM mode to maintain high efficiency at all loads. In PFM mode, the output ripple has a variable frequency component that changes with the input voltage and output current. With no load, the quiescent current drawn from the output is very low.

There are two comparators that decide when device starts switching in PFM mode. One of the comparators is monitoring the output voltage and has a reference of 810 mV with 10 mV hysteresis. If the load current is low, the output rises and triggers the comparator, which will put the logic control of the drivers and other block circuitry (including the internal regulator V_{CC}) in Sleep mode to minimize the power consumption during the switching cycle's off period. When the output voltage drops below its nominal value, PFM operation pulses one or several times to bring the output back into regulation (Figure 2-26). The second comparator fixes the minimum duty cycle for PFM mode. Minimum duty cycle in PFM mode depends on the sensed peak current and input voltage. As a result, the PFM-to-PWM mode threshold depends on load current and value of the input voltage (Figure 2-17). If the output load current rises above the upper threshold, the MCP16311 transitions smoothly into PWM mode.

4.2.5 HIGH-SIDE DRIVE

The MCP16311/2 features an integrated high-side N-Channel MOSFET for high-efficiency step-down power conversion. An N-Channel MOSFET is used for its low resistance and size (instead of a P-Channel MOSFET). The N-Channel MOSFET gate must be driven above its source to fully turn on the device, resulting in a gate-drive voltage above the input to turn on the high-side N-Channel. The high-side N-channel source is connected to the inductor and boost cap or switch node. When the high-side switch is off and the low-side switch is on, the inductor current flows through the low-side switch, providing a path to recharge the boost cap from the boost voltage source. The voltage for the boost cap is supplied from the internal regulator (VCC). An internal boost blocking diode is used to prevent current flow from the boost cap back into the regulator during the internal switch-on time.

MCP16311/2

NOTES:

5.0 APPLICATION INFORMATION

5.1 Typical Applications

The MCP16311/2 synchronous step-down converter operates over a wide input range, up to 30V maximum. Typical applications include generating a bias or V_{DD} voltage for PIC® microcontrollers, digital control system bias supply for AC-DC converters and 12V industrial input and similar applications.

5.2 Adjustable Output Voltage Calculations

To calculate the resistor divider values for the MCP16311/2 adjustable version, use Equation 5-1. R_{TOP} is connected to V_{OUT} , R_{BOT} is connected to A_{GND} , and both are connected to the V_{FB} input pin.

EQUATION 5-1: RESISTOR DIVIDER CALCULATION

$$R_{TOP} = R_{BOT} \times \left(\frac{V_{OUT}}{V_{FB}} - 1 \right)$$

EXAMPLE 5-1: 3.3V RESISTOR DIVIDER

$$\begin{aligned} V_{OUT} &= 3.3V \\ V_{FB} &= 0.8V \\ R_{BOT} &= 10\text{ k}\Omega \\ R_{TOP} &= 31.25\text{ k}\Omega \text{ (standard value = 31.6 k}\Omega\text{)} \\ V_{OUT} &= 3.328V \text{ (using standard value)} \end{aligned}$$

EXAMPLE 5-2: 5.0V RESISTOR DIVIDER

$$\begin{aligned} V_{OUT} &= 5.0V \\ V_{FB} &= 0.8V \\ R_{BOT} &= 10\text{ k}\Omega \\ R_{TOP} &= 52.5\text{ k}\Omega \text{ (standard value = 52.3 k}\Omega\text{)} \\ V_{OUT} &= 4.984V \text{ (using standard values)} \end{aligned}$$

EXAMPLE 5-3: 12.0V RESISTOR DIVIDER

$$\begin{aligned} V_{OUT} &= 12.0V \\ V_{FB} &= 0.8V \\ R_{BOT} &= 10\text{ k}\Omega \\ R_{TOP} &= 140\text{ k}\Omega \text{ (standard value = 140 k}\Omega\text{)} \end{aligned}$$

The error amplifier is internally compensated to ensure loop stability. External resistor dividers, inductance and output capacitance all have an impact on the control system and should be selected carefully and evaluated for stability. A 10 k Ω bottom resistor is recommended as a good trade-off for quiescent current and noise immunity.

5.3 General Design Equations

The step-down converter duty cycle can be estimated using Equation 5-2 while operating in Continuous Inductor Current mode. This equation accounts for the forward drop of the two internal N-Channel MOSFETS. As load current increases, the voltage drop in both internal switches will increase, requiring a larger PWM duty cycle to maintain the output voltage regulation. Switch voltage drop is estimated by multiplying the switch current times the switch resistance or $R_{DS(ON)}$.

EQUATION 5-2: CONTINUOUS INDUCTOR CURRENT DUTY CYCLE

$$D = \frac{V_{OUT} + (I_{LSW} \times R_{DS(ON)L})}{V_{IN} - (I_{HSW} \times R_{DS(ON)H})}$$

The MCP16311/2 device features an integrated slope compensation to prevent bimodal operation of the PWM duty cycle. Internally, half of the inductor current down slope is summed with the internal current sense signal. For the proper amount of slope compensation, it is recommended to keep the inductor down-slope current constant by varying the inductance with V_{OUT} , where $K = 0.22\text{ V}/\mu\text{H}$.

EQUATION 5-3:

$$K = V_{OUT}/L$$

For example, for $V_{OUT} = 3.3V$, an inductance of 15 μH is recommended.

TABLE 5-1: RECOMMENDED INDUCTOR VALUES

V_{OUT}	K	$L_{STANDARD}$
2.0V	0.20	10 μH
3.3V	0.22	15 μH
5.0V	0.23	22 μH
12V	0.21	56 μH
15V	0.22	68 μH
24V	0.24	100 μH

MCP16311/2

5.4 Input Capacitor Selection

The step-down converter input capacitor must filter the high-input ripple current that results from pulsing or chopping the input voltage. The MCP16311/2 input voltage pin is used to supply voltage for the power train and as a source for internal bias. A low equivalent series resistance (ESR), preferably a ceramic capacitor, is recommended. The necessary capacitance is dependent upon the maximum load current and source impedance. Three capacitor parameters to keep in mind are the voltage rating, equivalent series resistance and the temperature rating. For wide temperature range applications, a multi-layer X7R dielectric is recommended, while for applications with limited temperature range, a multi-layer X5R dielectric is acceptable. Typically, input capacitance between 10 μF and 20 μF is sufficient for most applications. For applications with 100 mA to 200 mA load, a 4.7 μF to 2.2 μF X7R capacitor can be used, depending on the input source and its impedance. In case of an application with high variations of the input voltage, a higher capacitor value is recommended. The input capacitor voltage rating must be V_{IN} plus margin.

Table 5-2 contains the recommended range for the input capacitor value.

5.5 Output Capacitor Selection

The output capacitor provides a stable output voltage during sudden load transients and reduces the output voltage ripple. As with the input capacitor, X5R and X7R ceramic capacitors are well suited for this application. For typical applications, the output capacitance can be as low as 10 μF ceramic and as high as 100 μF electrolytic. In a typical application, a 20 μF output capacitance usage will result in a 10 mV output ripple.

The amount and type of output capacitance and equivalent series resistance will have a significant effect on the output ripple voltage and system stability. The range of the output capacitance is limited due to the integrated compensation of the MCP16311/2. See Table 5-2 for the recommended output capacitor range.

The output voltage capacitor rating should be a minimum of V_{OUT} plus margin.

TABLE 5-2: CAPACITOR VALUE RANGE

Parameter	Min.	Max.
C_{IN}	2.2 μF	None
C_{OUT}	20 μF	None

5.6 Inductor Selection

The MCP16311/2 is designed to be used with small surface-mount inductors. Several specifications should be considered prior to selecting an inductor. To optimize system performance, low DCR inductors should be used.

To optimize system performance, the inductance value is determined by the output voltage (Table 5-1) so the inductor ripple current is somewhat constant over the output voltage range.

EQUATION 5-4: INDUCTOR RIPPLE CURRENT

$$\Delta I_L = \frac{V_{\text{IN}} - V_{\text{OUT}}}{L} \times t_{\text{ON}}$$

EXAMPLE 5-4:

$$\begin{aligned} V_{\text{IN}} &= 12\text{V} \\ V_{\text{OUT}} &= 3.3\text{V} \\ I_{\text{OUT}} &= 800\text{ mA} \end{aligned}$$

EQUATION 5-5: INDUCTOR PEAK CURRENT

$$I_{\text{LPK}} = \frac{\Delta I_L}{2} + I_{\text{OUT}}$$

Where:

$$\begin{aligned} \text{Inductor ripple current} &= 319\text{ mA} \\ \text{Inductor peak current} &= 960\text{ mA} \end{aligned}$$

For this example, an inductor with a current saturation rating of minimum 960 mA is recommended. Low DCR inductors result in higher system efficiency. A trade-off between size, cost and efficiency is made to achieve the desired results.

TABLE 5-3: MCP16311/2 RECOMMENDED 3.3V V_{OUT} INDUCTORS

Part Number	Value (μH)	DCR (Ω)	I_{SAT} (A)	Size WxLxH (mm)
Coilcraft				
XAL4040	15	0.109	2.8	4.0x4.0x2.1
LPS6235	15	0.125	2.00	6.0x6.0x3.5
MSS6132	15	0.135	1.56	6.1x6.1x3.2
XAL6060	15	0.057	1.78	6.36x6.5x6.1
MSS7341	15	0.057	1.78	7.3x7.3x4.1

TABLE 5-3: MCP16311/2 RECOMMENDED 3.3V V_{OUT} INDUCTORS

Part Number	Value (μH)	DCR (Ω)	I _{SAT} (A)	Size WxLxH (mm)
Würth Elektronik®				
74408943150	15	0.118	1.7	4.8x4.8x3.8
744062150	15	0.085	1.1	6.8x6.8x2.3
744778115	15	0.1	1.75	7.3x7.3x3.2
7447779115	15	0.07	2.2	7.3x7.3x4.5
Coiltronics®				
SD25	15	0.095	1.08	5.2x5.2x2.5
SD6030	14.1	0.103	1.1	6.0x6.0x3.0
TDK - EPC®				
B82462G4153M	15	0.097	1.05	6.0x6.0x3.0
B82462A4153K	15	0.21	1.5	6.0x6.0x3.0

5.7 Boost Capacitor

The boost capacitor is used to supply current for the internal high-side drive circuitry that is above the input voltage. The boost capacitor must store enough energy to completely drive the high-side switch on and off. A 100 nF X5R or X7R capacitor is recommended for all applications. The boost capacitor maximum voltage is 5V.

5.8 V_{CC} Capacitor

The V_{CC} internal bias regulates at 5V. The V_{CC} pin is current limited to 50 mA and protected from a short-circuit condition at 150 mA load. The V_{CC} regulator must sustain all load and line transients because it supplies the internal drivers for power switches. For stability reasons, the V_{CC} capacitor must be at least 1 μF X7R ceramic for extended temperature range, or X5R for limited temperature range.

5.9 MCP16312 – LED Constant Current Driver

MCP16312 can be used to drive an LED or a string of LEDs. The process of transforming the MCP16312 from a constant voltage source into a constant current source is simple. It implies that the sensing/feedback for the current is on the low side by adding a resistor in series with the string of LEDs.

When using the MCP16312 as an LED driver, care must be taken when selecting the sense resistor. Due to the high feedback voltage of 0.8V, there will be significant losses on the sense resistor, so a larger package with better power dissipation must be selected.

Another important aspect when creating such an application is the value of the inductor. The value of the inductor needs to follow Equation 5-3 or, as a guideline, Table 5-1, where the output voltage is approximated as the sum of the forward voltages of the LEDs and a 0.8V headroom for the sense resistor. A typical application is shown in Figure 5-3.

The following equations are used to determine the value and the losses for the sense resistor:

EQUATION 5-6:

$$R_B = \frac{V_{FB}}{I_{LED}}$$

$$P_{LOSSES} = V_{FB} \times I_{LED}$$

Where:

V_{FB} = Feedback Voltage

EXAMPLE 5-5:

$$I_{LED} = 400 \text{ mA}$$

$$V_{FB} = 0.8\text{V}$$

$$V_F = 1 \times 3.2\text{V (one white LED is used)}$$

$$R_B = 2\Omega$$

$$P_{LOSSES} = 0.32 \text{ W (sense resistor losses)}$$

$$L = 22 \mu\text{H}$$

5.10 Thermal Calculations

The MCP16311/2 is available in MSOP-8 and DFN-8 packages. By calculating the power dissipation and applying the package thermal resistance (θ_{JA}), the junction temperature is estimated. The maximum continuous junction temperature rating for the MCP16311/2 is +125°C.

To quickly estimate the internal power dissipation for the switching step-down regulator, an empirical calculation using measured efficiency can be used. Given the measured efficiency, the internal power dissipation is estimated in Equation 5-7. This power dissipation includes all internal and external component losses. For a quick internal estimate, subtract the estimated inductor DCR loss from the P_{DIS} calculation in Equation 5-7.

EQUATION 5-7: TOTAL POWER DISSIPATION ESTIMATE

$$P_{DIS} = \frac{V_{OUT} \times I_{OUT}}{\text{Efficiency}} - (V_{OUT} \times I_{OUT})$$

MCP16311/2

The difference between the first term, input power, and the second term, power delivered, is the total system power dissipation. The inductor losses are estimated by $P_L = I_{OUT}^2 \times L_{DCR}$.

EXAMPLE 5-6: POWER DISSIPATION – MCP16311/2 MSOP PACKAGE

$$\begin{aligned}V_{IN} &= 12V \\V_{OUT} &= 5.0V \\I_{OUT} &= 0.8A \\ \text{Efficiency} &= 92.5\% \\ \text{Total System Dissipation} &= 324 \text{ mW} \\L_{DCR} &= 0.15 \Omega \\P_L &= 96 \text{ mW}\end{aligned}$$

MCP16311/2 internal power dissipation estimate:

$$\begin{aligned}P_{DIS} - P_L &= 228 \text{ mW} \\ \theta_{JA} &= 211^\circ\text{C/W} \\ \text{Estimated Junction} &= +48.1^\circ\text{C} \\ \text{Temperature Rise}\end{aligned}$$

EXAMPLE 5-7: POWER DISSIPATION – MCP16311/2 DFN PACKAGE

$$\begin{aligned}V_{IN} &= 12V \\V_{OUT} &= 3.3V \\I_{OUT} &= 0.8A \\ \text{Efficiency} &= 90\% \\ \text{Total System Dissipation} &= 293 \text{ mW} \\L_{DCR} &= 0.15 \Omega \\P_L &= 96 \text{ mW}\end{aligned}$$

MCP16311 internal power dissipation estimate:

$$\begin{aligned}P_{DIS} - P_L &= 197 \text{ mW} \\ \theta_{JA} &= 68^\circ\text{C/W} \\ \text{Estimated Junction} &= +13.4^\circ\text{C} \\ \text{Temperature Rise}\end{aligned}$$

5.11 Printed Circuit Board (PCB) Layout Information

Good PCB layout techniques are important to any switching circuitry, and switching power supplies are no different. When wiring the switching high-current paths, short and wide traces should be used. Therefore, it is important that the input and output capacitors be placed as close as possible to the MCP16311/2 to minimize the loop area.

The feedback resistors and feedback signal should be routed away from the switching node and the switching current loop. When possible, ground planes and traces should be used to help shield the feedback signal and minimize noise and magnetic interference.

A good MCP16311/2 layout starts with the placement of the input capacitor, which supplies current to the input of the circuit when the switch is turned on. In addition to

supplying high-frequency switch current, the input capacitor also provides a stable voltage source for the internal MCP16311/2 circuitry. Unstable PWM operation can result if there are excessive transients or ringing on the V_{IN} pin of the MCP16311/2 device. In [Figure 5-1](#), the input capacitors are placed close to the V_{IN} pins. A ground plane on the bottom of the board provides a low-resistive and low-inductive path for the return current. The next priority in placement is the freewheeling current loop formed by output capacitors and inductance (L1), while strategically placing the output capacitor ground return close to the input capacitor ground return. Then, C_{BOOST} should be placed between the boost pin and the switch node pin. This leaves space close to the MCP16311/2 V_{FB} pin to place R_{TOP} and R_{BOT} . The feedback loop must be routed away from the switch node, so noise is not coupled into the high-impedance V_{FB} input.

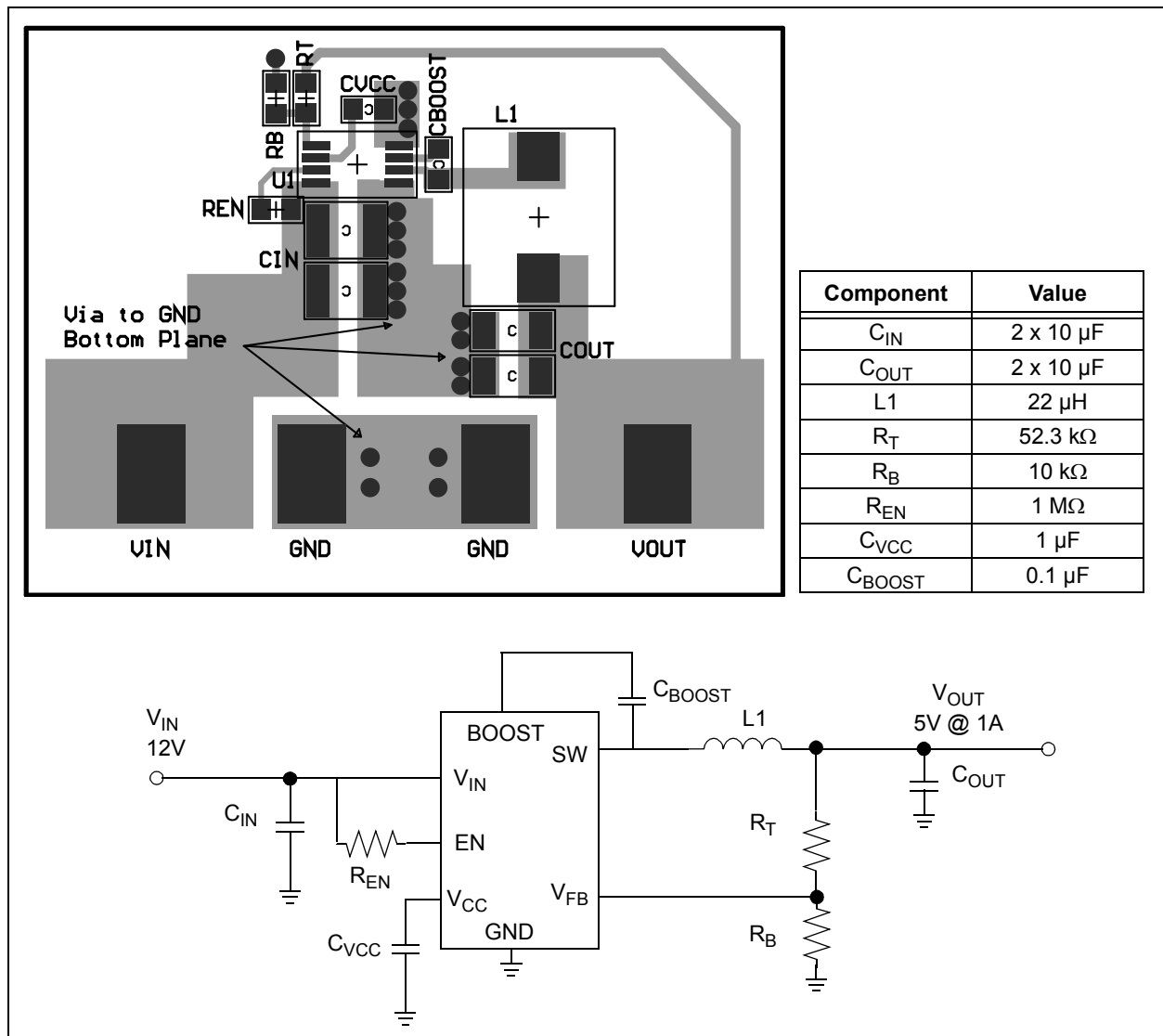

FIGURE 5-1: MSOP-8 Recommended Layout, 5V Output Design.

MCP16311/2

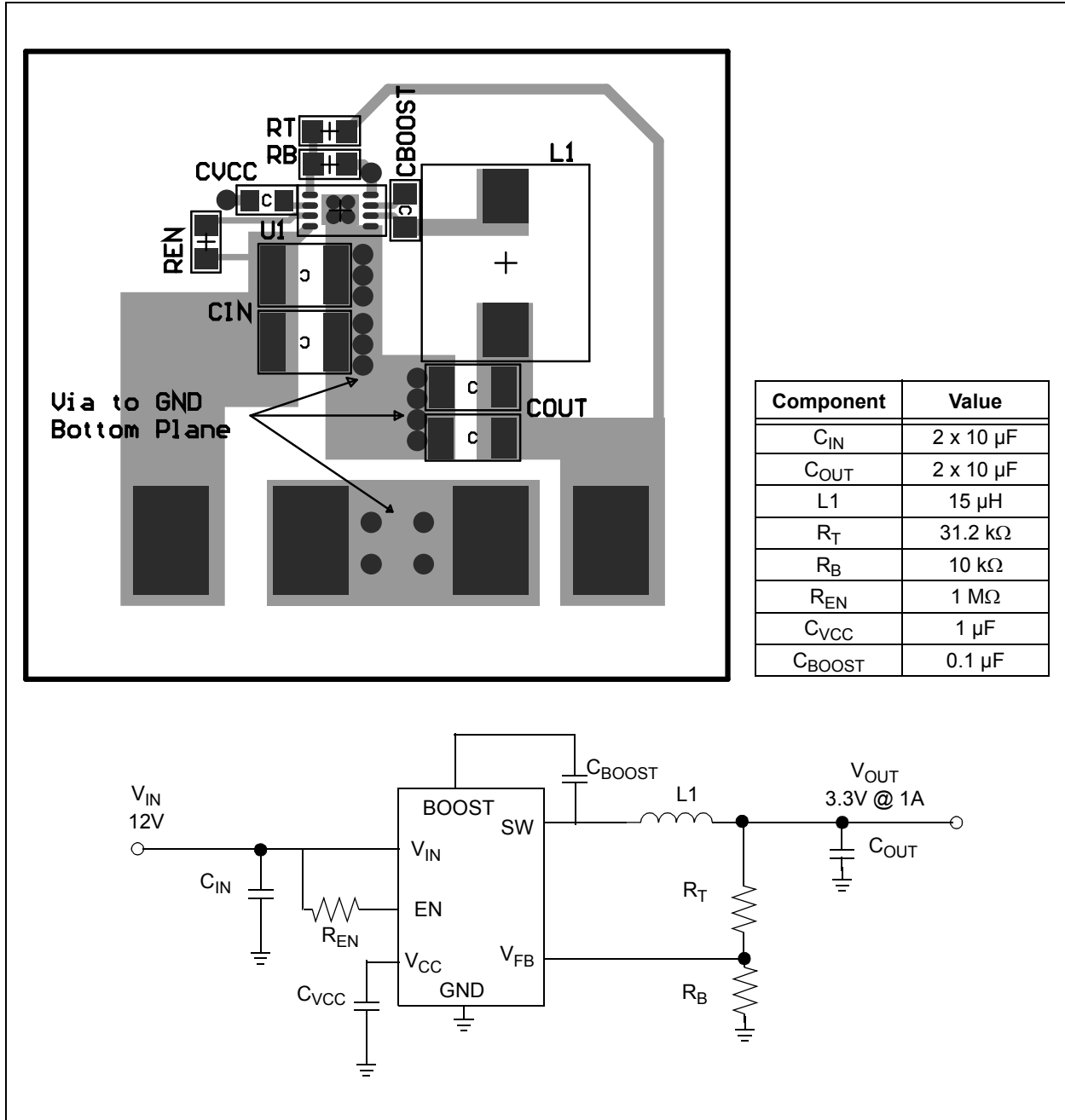

FIGURE 5-2: DFN Recommended Layout, 3.3V Output Design.

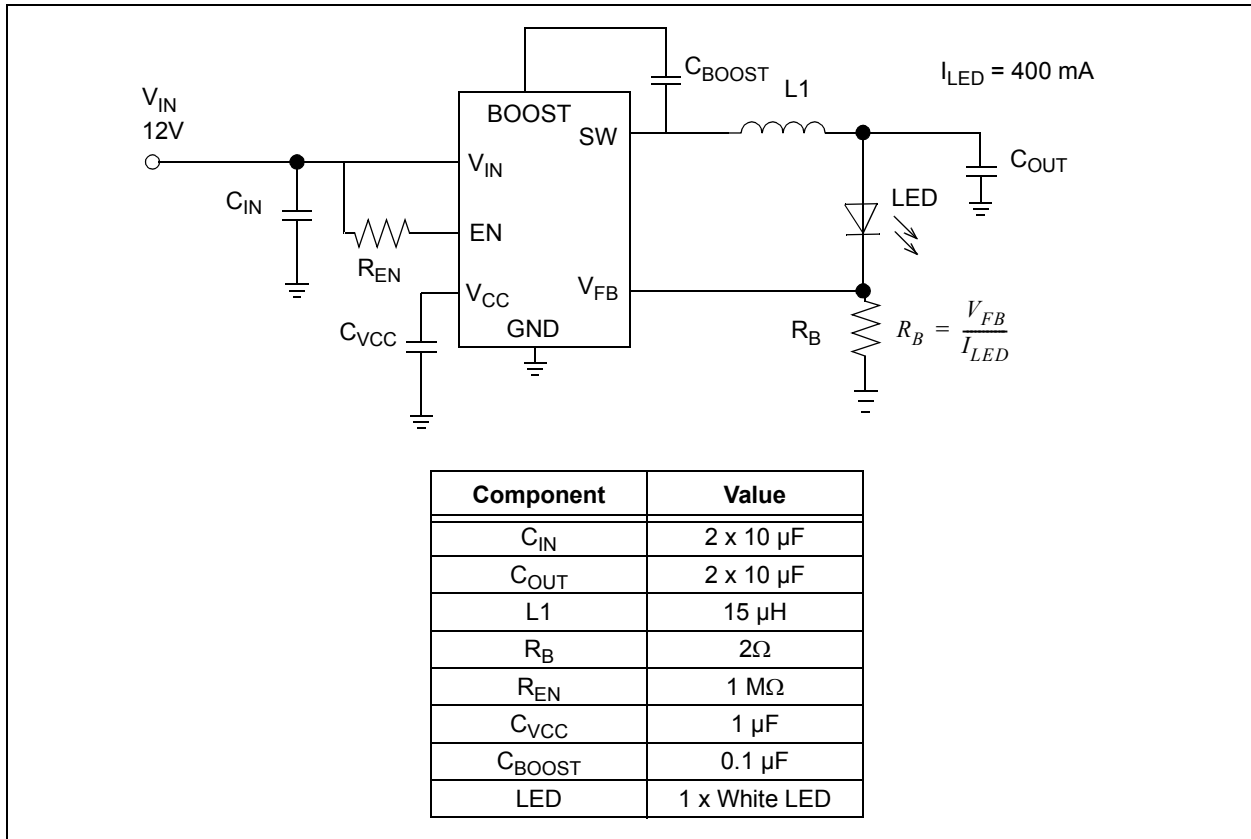

FIGURE 5-3: MCP16312 - Typical LED Driver Application: 400 mA Output.

MCP16311/2

NOTES:

6.0 PACKAGING INFORMATION

6.1 Package Marking Information

8-Lead MSOP (3x3 mm)

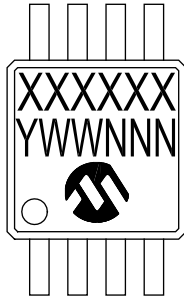

Example

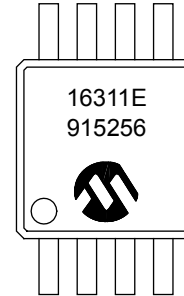

8-Lead TDFN (2x3)



Part Number	Code
MCP16311T-E/MNY	ABM
MCP16312T-E/MNY	ABU

Example

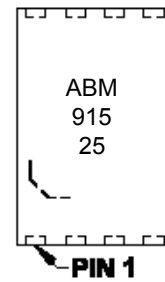

Legend:	XX...X	Customer-specific information
	Y	Year code (last digit of calendar year)
	YY	Year code (last 2 digits of calendar year)
	WW	Week code (week of January 1 is week '01')
	NNN	Alphanumeric traceability code
	(e3)	Pb-free JEDEC® designator for Matte Tin (Sn)
	*	This package is Pb-free. The Pb-free JEDEC designator (e3) can be found on the outer packaging for this package.
Note:	In the event the full Microchip part number cannot be marked on one line, it will be carried over to the next line, thus limiting the number of available characters for customer-specific information.	

MCP16311/2

8-Lead Plastic Micro Small Outline Package (MS) [MSOP]

Note: For the most current package drawings, please see the Microchip Packaging Specification located at <http://www.microchip.com/packaging>

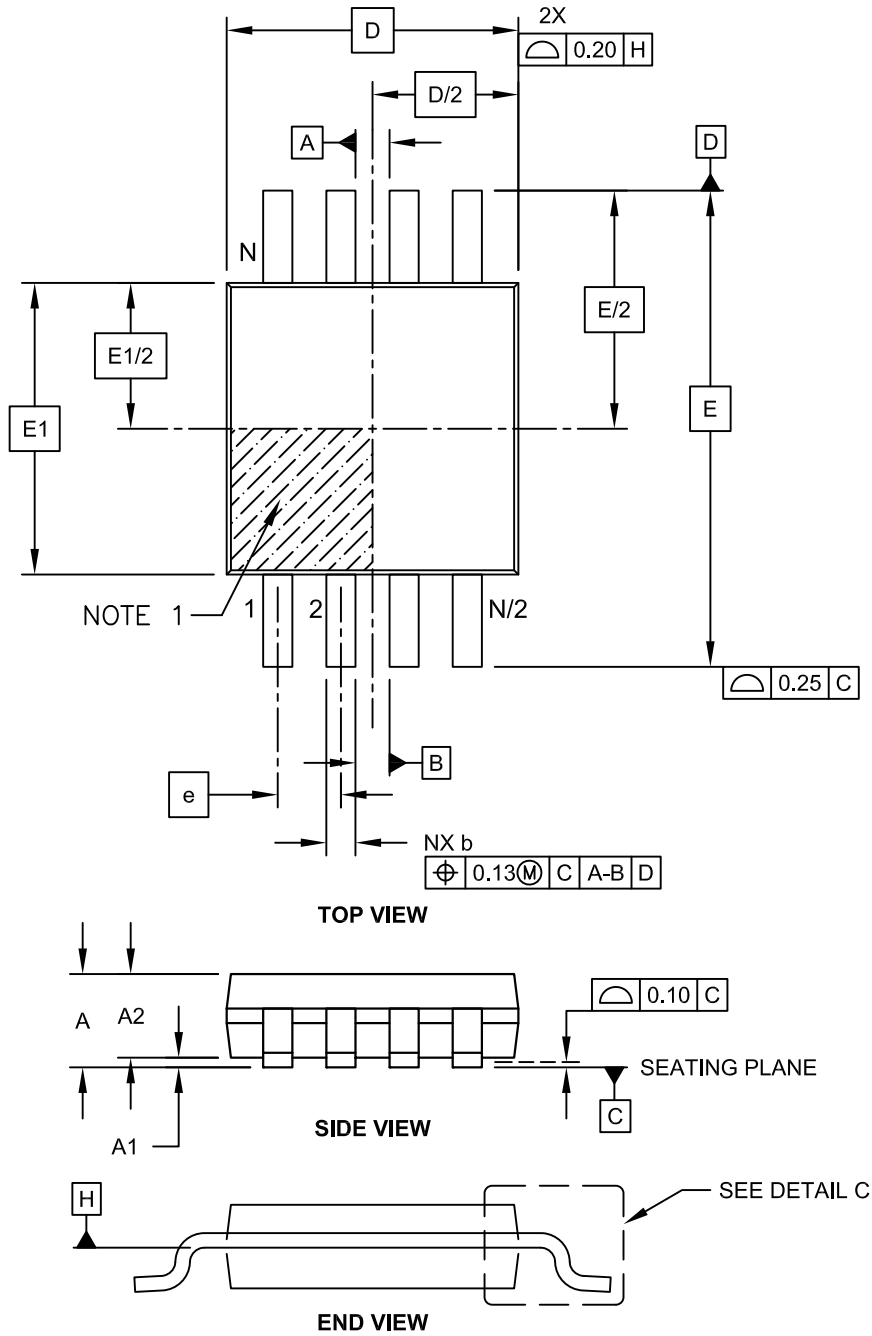

Microchip Technology Drawing C04-111C Sheet 1 of 2

8-Lead Plastic Micro Small Outline Package (MS) [MSOP]

Note: For the most current package drawings, please see the Microchip Packaging Specification located at <http://www.microchip.com/packaging>

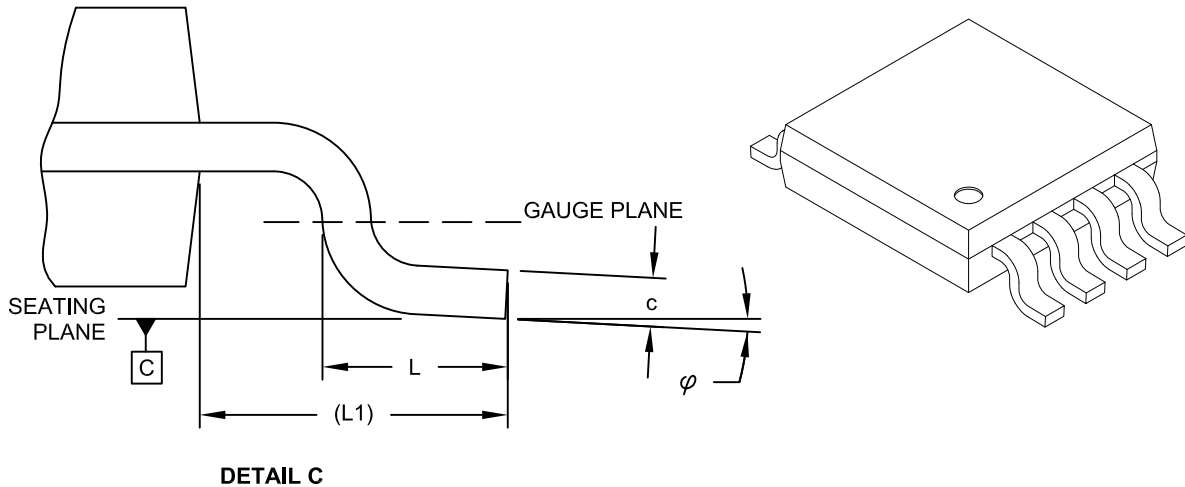

Dimension Limits	Units	MILLIMETERS		
		MIN	NOM	MAX
Number of Pins	N	8		
Pitch	e	0.65 BSC		
Overall Height	A	-	-	1.10
Molded Package Thickness	A2	0.75	0.85	0.95
Standoff	A1	0.00	-	0.15
Overall Width	E	4.90 BSC		
Molded Package Width	E1	3.00 BSC		
Overall Length	D	3.00 BSC		
Foot Length	L	0.40	0.60	0.80
Footprint	L1	0.95 REF		
Foot Angle	ϕ	0°	-	8°
Lead Thickness	c	0.08	-	0.23
Lead Width	b	0.22	-	0.40

Notes:

- Pin 1 visual index feature may vary, but must be located within the hatched area.
- Dimensions D and E1 do not include mold flash or protrusions. Mold flash or protrusions shall not exceed 0.15mm per side.
- Dimensioning and tolerancing per ASME Y14.5M.
 BSC: Basic Dimension. Theoretically exact value shown without tolerances.
 REF: Reference Dimension, usually without tolerance, for information purposes only.

Microchip Technology Drawing C04-111C Sheet 2 of 2

MCP16311/2

8-Lead Plastic Micro Small Outline Package (MS) [MSOP]

Note: For the most current package drawings, please see the Microchip Packaging Specification located at <http://www.microchip.com/packaging>

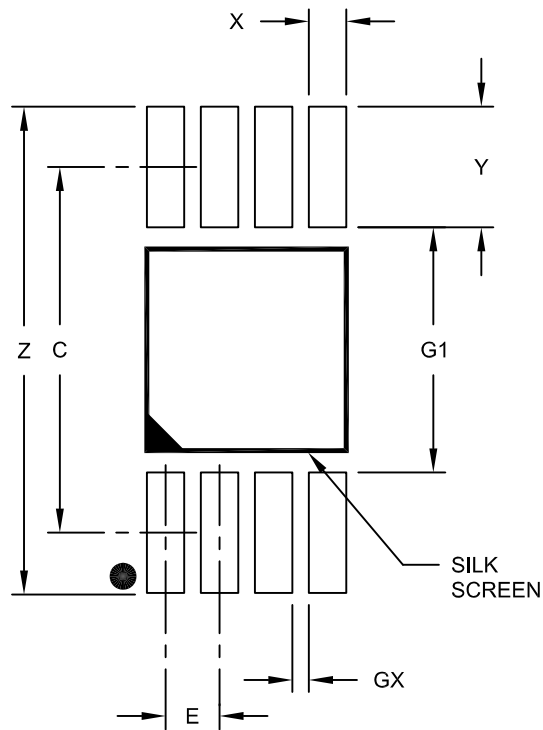

RECOMMENDED LAND PATTERN

Dimension Limits	Units	MILLIMETERS		
		MIN	NOM	MAX
Contact Pitch	E	0.65 BSC		
Contact Pad Spacing	C		4.40	
Overall Width	Z			5.85
Contact Pad Width (X8)	X1			0.45
Contact Pad Length (X8)	Y1			1.45
Distance Between Pads	G1	2.95		
Distance Between Pads	GX	0.20		

Notes:

1. Dimensioning and tolerancing per ASME Y14.5M

BSC: Basic Dimension. Theoretically exact value shown without tolerances.

Microchip Technology Drawing No. C04-2111A

8-Lead Plastic Dual Flat, No Lead Package (MNY) – 2x3x0.8 mm Body [TDFN] With 1.4x1.3 mm Exposed Pad (JEDEC Package type WDFN)

Note: For the most current package drawings, please see the Microchip Packaging Specification located at <http://www.microchip.com/packaging>

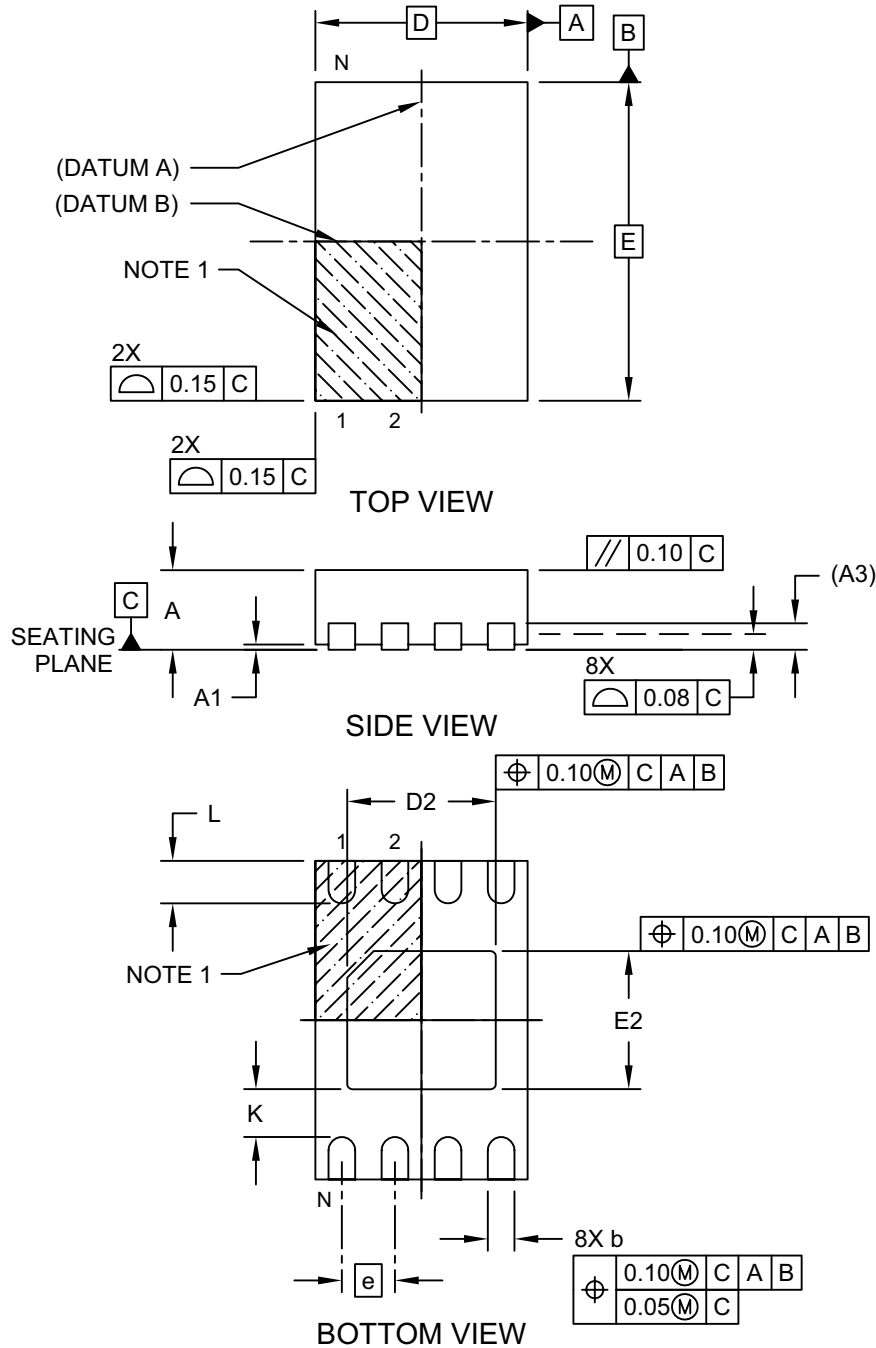

Microchip Technology Drawing No. C04-129-MNY Rev E Sheet 1 of 2

MCP16311/2

8-Lead Plastic Dual Flat, No Lead Package (MNY) – 2x3x0.8 mm Body [TDFN] With 1.4x1.3 mm Exposed Pad (JEDEC Package type WDFN)

Note: For the most current package drawings, please see the Microchip Packaging Specification located at <http://www.microchip.com/packaging>

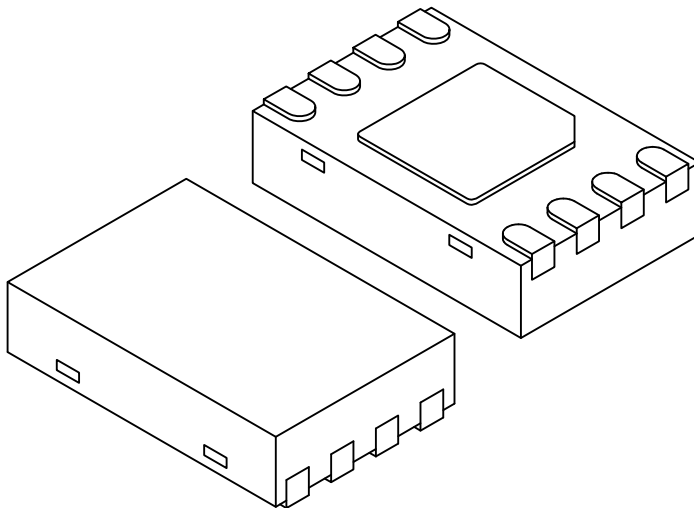

Dimension Limits	Units	MILLIMETERS		
		MIN	NOM	MAX
Number of Pins	N	8		
Pitch	e	0.50 BSC		
Overall Height	A	0.70	0.75	0.80
Standoff	A1	0.00	0.02	0.05
Contact Thickness	A3	0.20 REF		
Overall Length	D	2.00 BSC		
Overall Width	E	3.00 BSC		
Exposed Pad Length	D2	1.35	1.40	1.45
Exposed Pad Width	E2	1.25	1.30	1.35
Contact Width	b	0.20	0.25	0.30
Contact Length	L	0.25	0.30	0.45
Contact-to-Exposed Pad	K	0.20	-	-

Notes:

1. Pin 1 visual index feature may vary, but must be located within the hatched area.
2. Package may have one or more exposed tie bars at ends.
3. Package is saw singulated
4. Dimensioning and tolerancing per ASME Y14.5M

BSC: Basic Dimension. Theoretically exact value shown without tolerances.

REF: Reference Dimension, usually without tolerance, for information purposes only.

Microchip Technology Drawing No. C04-129-MNY Rev E Sheet 2 of 2

8-Lead Plastic Dual Flat, No Lead Package (MNY) – 2x3x0.8 mm Body [TDFN] With 1.4x1.3 mm Exposed Pad (JEDEC Package type WDFN)

Note: For the most current package drawings, please see the Microchip Packaging Specification located at <http://www.microchip.com/packaging>

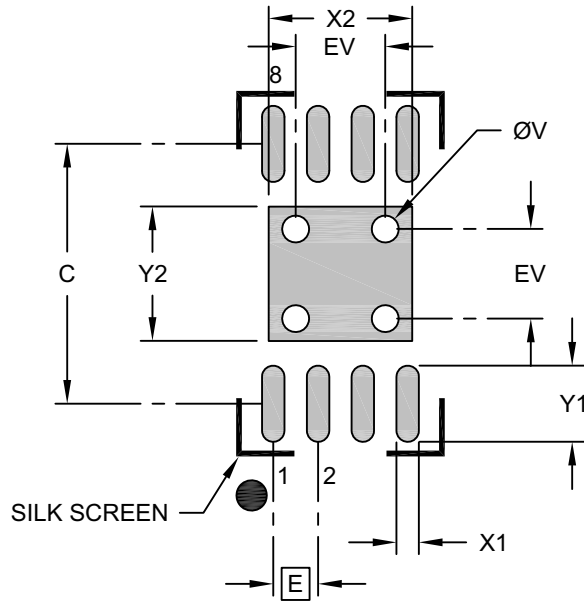

RECOMMENDED LAND PATTERN

Dimension Limits	Units	MILLIMETERS		
		MIN	NOM	MAX
Contact Pitch	E	0.50 BSC		
Optional Center Pad Width	X2			1.60
Optional Center Pad Length	Y2			1.50
Contact Pad Spacing	C		2.90	
Contact Pad Width (X8)	X1			0.25
Contact Pad Length (X8)	Y1			0.85
Thermal Via Diameter	V		0.30	
Thermal Via Pitch	EV		1.00	

Notes:

- Dimensioning and tolerancing per ASME Y14.5M
BSC: Basic Dimension. Theoretically exact value shown without tolerances.
- For best soldering results, thermal vias, if used, should be filled or tented to avoid solder loss during reflow process

Microchip Technology Drawing No. C04-129-MNY Rev. B

MCP16311/2

NOTES:

APPENDIX A: REVISION HISTORY

Revision C (July 2019)

1. Updated [Table 4-1](#) in [Section 4.1.2](#) “[PWM-only Mode Option](#)”.
2. Updated [Section 4.2.5](#) “[HIGH-SIDE DRIVE](#)”.
3. Updated Package Drawings for 2 x 3 mm 8-Lead TDFN in [Section 6.1](#) “[Package Marking Information](#)”.
4. Updated [Product Identification System](#) Section.

Revision B (November 2014)

The following is the list of modifications:

1. Added AEC-Q100 qualification information.
2. Updated the [Typical Applications](#) section.
3. Updated the [DC Characteristics](#) table.
4. Updated [Section 4.2.2](#) “[Peak Current Mode Control](#)”.
5. Updated the standard values in [Example 5-1](#).
6. Added a 24V option in [Table 5-1](#).

Revision A (December 2013)

- Original release of this document.

MCP16311/2

NOTES:

PRODUCT IDENTIFICATION SYSTEM

To order or obtain information, e.g., on pricing or delivery, refer to the factory or the listed sales office.

<u>PART NO.</u>	<u>X1⁽¹⁾</u>	-	<u>X</u>	<u>/XX</u>	
Device	Tape and Reel Option		Temperature Range	Package	
Device:	MCP16311:		High-Efficiency, PFM/PWM Integrated Synchronous Switch Step-Down Regulator (MSOP only)		
	MCP16311T:		High-Efficiency, PFM/PWM Integrated Synchronous Switch Step-Down Regulator (Tape and Reel) (MSOP and TDFN)		
	MCP16312:		High-Efficiency, PFM Integrated Synchronous Switch Step-Down Regulator (MSOP only)		
	MCP16312T:		High-Efficiency, PWM Integrated Synchronous Switch Step-Down Regulator (Tape and Reel) (MSOP and TDFN)		
Tape and Reel Option:	Blank	=	Standard packaging (tube or tray)		
	T	=	Tape and Reel ⁽¹⁾		
Temperature Range:	E	=	-40°C to +125°C (Extended)		
Package:	MS	=	8-Lead Plastic Micro Small Outline Package, MSOP		
	MNY*	=	8-Lead Plastic Dual Flat, No Lead Package, 2 x 3 x 0.8 mm Body, TDFN		
	*Y	=	Nickel palladium gold manufacturing designator		
					Examples:
					a) MCP16311-E/MS: Extended temperature, 8LD MSOP package
					b) MCP16311T-E/MS: Tape and Reel, Extended temperature, 8LD MSOP package
					c) MCP16311T-E/MNY: Tape and Reel, Extended temperature, 8LD2 x 3 TDFN package
					a) MCP16312-E/MS: Extended temperature, 8LD MSOP package
					b) MCP16312T-E/MS: Tape and Reel, Extended temperature, 8LD MSOP package
					c) MCP16312T-E/MNY: Tape and Reel, Extended temperature, 8LD2 x 3 TDFN package
					Note 1: Tape and Reel identifier only appears in the catalog part number description. This identifier is used for ordering purposes and is not printed on the device package. Check with your Microchip Sales Office for package availability with the Tape and Reel option.

MCP16311/2

NOTES:

Note the following details of the code protection feature on Microchip devices:

- Microchip products meet the specification contained in their particular Microchip Data Sheet.
- Microchip believes that its family of products is one of the most secure families of its kind on the market today, when used in the intended manner and under normal conditions.
- There are dishonest and possibly illegal methods used to breach the code protection feature. All of these methods, to our knowledge, require using the Microchip products in a manner outside the operating specifications contained in Microchip's Data Sheets. Most likely, the person doing so is engaged in theft of intellectual property.
- Microchip is willing to work with the customer who is concerned about the integrity of their code.
- Neither Microchip nor any other semiconductor manufacturer can guarantee the security of their code. Code protection does not mean that we are guaranteeing the product as “unbreakable.”

Code protection is constantly evolving. We at Microchip are committed to continuously improving the code protection features of our products. Attempts to break Microchip's code protection feature may be a violation of the Digital Millennium Copyright Act. If such acts allow unauthorized access to your software or other copyrighted work, you may have a right to sue for relief under that Act.

Information contained in this publication regarding device applications and the like is provided only for your convenience and may be superseded by updates. It is your responsibility to ensure that your application meets with your specifications. MICROCHIP MAKES NO REPRESENTATIONS OR WARRANTIES OF ANY KIND WHETHER EXPRESS OR IMPLIED, WRITTEN OR ORAL, STATUTORY OR OTHERWISE, RELATED TO THE INFORMATION, INCLUDING BUT NOT LIMITED TO ITS CONDITION, QUALITY, PERFORMANCE, MERCHANTABILITY OR FITNESS FOR PURPOSE. Microchip disclaims all liability arising from this information and its use. Use of Microchip devices in life support and/or safety applications is entirely at the buyer's risk, and the buyer agrees to defend, indemnify and hold harmless Microchip from any and all damages, claims, suits, or expenses resulting from such use. No licenses are conveyed, implicitly or otherwise, under any Microchip intellectual property rights unless otherwise stated.

Trademarks

The Microchip name and logo, the Microchip logo, Adaptec, AnyRate, AVR, AVR logo, AVR Freaks, BesTime, BitCloud, chipKIT, chipKIT logo, CryptoMemory, CryptoRF, dsPIC, FlashFlex, flexPWR, HELDO, IGLOO, JukeBlox, KeeLoq, Klear, LANCheck, LinkMD, maXStylus, maXTouch, MediaLB, megaAVR, Microsemi, Microsemi logo, MOST, MOST logo, MPLAB, OptoLyzer, PackeTime, PIC, picoPower, PICSTART, PIC32 logo, PolarFire, Prochip Designer, QTouch, SAM-BA, SenGenuity, SpyNIC, SST, SST Logo, SuperFlash, Symmetricom, SyncServer, Tachyon, TempTrackr, TimeSource, tinyAVR, UNI/O, Vectron, and XMEGA are registered trademarks of Microchip Technology Incorporated in the U.S.A. and other countries.

APT, ClockWorks, The Embedded Control Solutions Company, EtherSynch, FlashTec, Hyper Speed Control, HyperLight Load, IntelliMOS, Libero, motorBench, mTouch, Powermite 3, Precision Edge, ProASIC, ProASIC Plus, ProASIC Plus logo, Quiet-Wire, SmartFusion, SyncWorld, Temux, TimeCesium, TimeHub, TimePictra, TimeProvider, Vite, WinPath, and ZL are registered trademarks of Microchip Technology Incorporated in the U.S.A.

Adjacent Key Suppression, AKS, Analog-for-the-Digital Age, Any Capacitor, AnyIn, AnyOut, BlueSky, BodyCom, CodeGuard, CryptoAuthentication, CryptoAutomotive, CryptoCompanion, CryptoController, dsPICDEM, dsPICDEM.net, Dynamic Average Matching, DAM, ECAN, EtherGREEN, In-Circuit Serial Programming, ICSP, INICnet, Inter-Chip Connectivity, JitterBlocker, KlearNet, KlearNet logo, memBrain, Mindi, MiWi, MPASM, MPF, MPLAB Certified logo, MPLIB, MPLINK, MultiTRAK, NetDetach, Omniscient Code Generation, PICDEM, PICDEM.net, PICKit, PICtail, PowerSmart, PureSilicon, QMatrix, REAL ICE, Ripple Blocker, SAM-ICE, Serial Quad I/O, SMART-I.S., SQI, SuperSwitcher, SuperSwitcher II, Total Endurance, TSHARC, USBCheck, VariSense, ViewSpan, WiperLock, Wireless DNA, and ZENA are trademarks of Microchip Technology Incorporated in the U.S.A. and other countries.

SQTP is a service mark of Microchip Technology Incorporated in the U.S.A.

The Adaptec logo, Frequency on Demand, Silicon Storage Technology, and Symmcom are registered trademarks of Microchip Technology Inc. in other countries.

GestIC is a registered trademark of Microchip Technology Germany II GmbH & Co. KG, a subsidiary of Microchip Technology Inc., in other countries.

All other trademarks mentioned herein are property of their respective companies.

© 2019, Microchip Technology Incorporated, All Rights Reserved.

ISBN: 978-1-5224-4779-5

For information regarding Microchip's Quality Management Systems, please visit www.microchip.com/quality.



MICROCHIP

Worldwide Sales and Service

AMERICAS

Corporate Office
2355 West Chandler Blvd.
Chandler, AZ 85224-6199
Tel: 480-792-7200
Fax: 480-792-7277
Technical Support:
<http://www.microchip.com/support>
Web Address:
www.microchip.com

Atlanta

Duluth, GA
Tel: 678-957-9614
Fax: 678-957-1455

Austin, TX

Tel: 512-257-3370

Boston

Westborough, MA
Tel: 774-760-0087
Fax: 774-760-0088

Chicago

Itasca, IL
Tel: 630-285-0071
Fax: 630-285-0075

Dallas

Addison, TX
Tel: 972-818-7423
Fax: 972-818-2924

Detroit

Novi, MI
Tel: 248-848-4000

Houston, TX

Tel: 281-894-5983

Indianapolis

Noblesville, IN
Tel: 317-773-8323
Fax: 317-773-5453
Tel: 317-536-2380

Los Angeles

Mission Viejo, CA
Tel: 949-462-9523
Fax: 949-462-9608
Tel: 951-273-7800

Raleigh, NC

Tel: 919-844-7510

New York, NY

Tel: 631-435-6000

San Jose, CA

Tel: 408-735-9110
Tel: 408-436-4270

Canada - Toronto

Tel: 905-695-1980
Fax: 905-695-2078

ASIA/PACIFIC

Australia - Sydney
Tel: 61-2-9868-6733

China - Beijing
Tel: 86-10-8569-7000

China - Chengdu
Tel: 86-28-8665-5511

China - Chongqing
Tel: 86-23-8980-9588

China - Dongguan
Tel: 86-769-8702-9880

China - Guangzhou
Tel: 86-20-8755-8029

China - Hangzhou
Tel: 86-571-8792-8115

China - Hong Kong SAR
Tel: 852-2943-5100

China - Nanjing
Tel: 86-25-8473-2460

China - Qingdao
Tel: 86-532-8502-7355

China - Shanghai
Tel: 86-21-3326-8000

China - Shenyang
Tel: 86-24-2334-2829

China - Shenzhen
Tel: 86-755-8864-2200

China - Suzhou
Tel: 86-186-6233-1526

China - Wuhan
Tel: 86-27-5980-5300

China - Xian
Tel: 86-29-8833-7252

China - Xiamen
Tel: 86-592-2388138

China - Zhuhai
Tel: 86-756-3210040

ASIA/PACIFIC

India - Bangalore
Tel: 91-80-3090-4444

India - New Delhi
Tel: 91-11-4160-8631

India - Pune
Tel: 91-20-4121-0141

Japan - Osaka
Tel: 81-6-6152-7160

Japan - Tokyo
Tel: 81-3-6880-3770

Korea - Daegu
Tel: 82-53-744-4301

Korea - Seoul
Tel: 82-2-554-7200

Malaysia - Kuala Lumpur
Tel: 60-3-7651-7906

Malaysia - Penang
Tel: 60-4-227-8870

Philippines - Manila
Tel: 63-2-634-9065

Singapore
Tel: 65-6334-8870

Taiwan - Hsin Chu
Tel: 886-3-577-8366

Taiwan - Kaohsiung
Tel: 886-7-213-7830

Taiwan - Taipei
Tel: 886-2-2508-8600

Thailand - Bangkok
Tel: 66-2-694-1351

Vietnam - Ho Chi Minh
Tel: 84-28-5448-2100

EUROPE

Austria - Wels
Tel: 43-7242-2244-39
Fax: 43-7242-2244-393

Denmark - Copenhagen
Tel: 45-4450-2828
Fax: 45-4485-2829

Finland - Espoo
Tel: 358-9-4520-820

France - Paris
Tel: 33-1-69-53-63-20
Fax: 33-1-69-30-90-79

Germany - Garching
Tel: 49-8931-9700

Germany - Haan
Tel: 49-2129-3766400

Germany - Heilbronn
Tel: 49-7131-72400

Germany - Karlsruhe
Tel: 49-721-625370

Germany - Munich
Tel: 49-89-627-144-0
Fax: 49-89-627-144-44

Germany - Rosenheim
Tel: 49-8031-354-560

Israel - Ra'anana
Tel: 972-9-744-7705

Italy - Milan
Tel: 39-0331-742611
Fax: 39-0331-466781

Italy - Padova
Tel: 39-049-7625286

Netherlands - Drunen
Tel: 31-416-690399
Fax: 31-416-690340

Norway - Trondheim
Tel: 47-7288-4388

Poland - Warsaw
Tel: 48-22-3325737

Romania - Bucharest
Tel: 40-21-407-87-50

Spain - Madrid
Tel: 34-91-708-08-90
Fax: 34-91-708-08-91

Sweden - Gothenberg
Tel: 46-31-704-60-40

Sweden - Stockholm
Tel: 46-8-5090-4654

UK - Wokingham
Tel: 44-118-921-5800
Fax: 44-118-921-5820