

MC14504B

Hex Level Shifter for TTL to CMOS or CMOS to CMOS

The MC14504B is a hex non-inverting level shifter using CMOS technology. The level shifter will shift a TTL signal to CMOS logic levels for any CMOS supply voltage between 5 and 15 volts. A control input also allows interface from CMOS to CMOS at one logic level to another logic level: Either up or down level translating is accomplished by selection of power supply levels V_{DD} and V_{CC} . The V_{CC} level sets the input signal levels while V_{DD} selects the output voltage levels.

Features

- UP Translates from a Low to a High Voltage or DOWN Translates from a High to a Low Voltage
- Input Threshold Can Be Shifted for TTL Compatibility
- No Sequencing Required on Power Supplies or Inputs for Power Up or Power Down
- 3 to 18 Vdc Operation for V_{DD} and V_{CC}
- Diode Protected Inputs to V_{SS}
- Capable of Driving Two Low-Power TTL Loads or One Low-Power Schottky TTL Load Over the Rated Temperature Range
- NLV Prefix for Automotive and Other Applications Requiring Unique Site and Control Change Requirements; AEC-Q100 Qualified and PPAP Capable
- These Devices are Pb-Free and are RoHS Compliant

MAXIMUM RATINGS (Voltages Referenced to V_{SS})

| Symbol | Parameter | Value | Unit |
|-------------------|---|------------------------|-------------|
| V_{CC} | DC Supply Voltage Range | -0.5 to +18.0 | V |
| V_{DD} | DC Supply Voltage Range | -0.5 to +18.0 | V |
| V_{in} | Input Voltage Range (DC or Transient) | -0.5 to +18.0 | V |
| V_{out} | Output Voltage Range (DC or Transient) | -0.5 to $V_{DD} + 0.5$ | V |
| I_{in}, I_{out} | Input or Output Current (DC or Transient) per Pin | ± 10 | mA |
| P_D | Power Dissipation, per Package (Note 1) | 500 | mW |
| T_A | Ambient Temperature Range | -55 to +125 | $^{\circ}C$ |
| T_{stg} | Storage Temperature Range | -65 to +150 | $^{\circ}C$ |
| T_L | Lead Temperature (8-Second Soldering) | 260 | $^{\circ}C$ |

Stresses exceeding those listed in the Maximum Ratings table may damage the device. If any of these limits are exceeded, device functionality should not be assumed, damage may occur and reliability may be affected.

1. Temperature Derating: "D/DW" Packages: -7.0 mW/ $^{\circ}C$ From 65 $^{\circ}C$ To 125 $^{\circ}C$

This device contains protection circuitry to guard against damage due to high static voltages or electric fields. However, precautions must be taken to avoid applications of any voltage higher than maximum rated voltages to this high-impedance circuit. For proper operation, V_{in} and V_{out} should be constrained to the range $V_{SS} \leq (V_{in} \text{ or } V_{out}) \leq V_{DD}$.

Unused inputs must always be tied to an appropriate logic voltage level (e.g., either V_{SS} or V_{DD}). Unused outputs must be left open.



ON Semiconductor®

<http://onsemi.com>

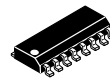

SOIC-16
D SUFFIX
CASE 751B



SOEIAJ-16
F SUFFIX
CASE 966

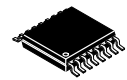

TSSOP-16
DT SUFFIX
CASE 948F

PIN ASSIGNMENT

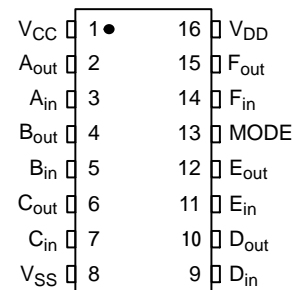

MARKING DIAGRAMS

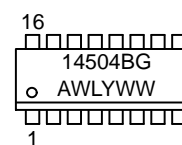

SOIC-16

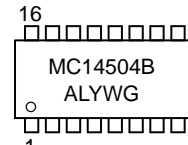

SOEIAJ-16

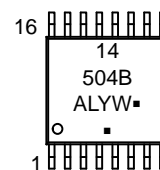

TSSOP-16

- A = Assembly Location
- WL, L = Wafer Lot
- YY, Y = Year
- WW, W = Work Week
- G or ■ = Pb-Free Indicator

(Note: Microdot may be in either location)

ORDERING INFORMATION

See detailed ordering and shipping information in the package dimensions section on page 2 of this data sheet.

MC14504B

LOGIC DIAGRAM

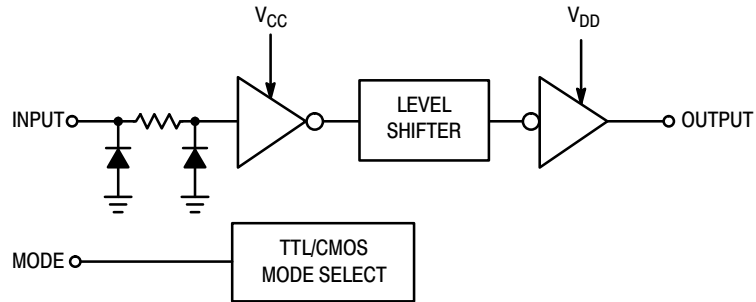

| Mode Select | Input Logic Levels | Output Logic Levels |
|----------------------|--------------------|---------------------|
| 1 (V _{CC}) | TTL | CMOS |
| 0 (V _{SS}) | CMOS | CMOS |

1/6 of package shown.

ORDERING INFORMATION

| Device | Package | Shipping [†] |
|-----------------|------------------------|--------------------------|
| MC14504BDG | SOIC-16 (Pb-Free) | 48 Units / Rail |
| NLV14504BDG* | | |
| MC14504BDR2G | SOIC-16 (Pb-Free) | 2500 Units / Tape & Reel |
| NLV14504BDR2G* | | |
| MC14504BDTG | TSSOP-16 (Pb-Free) | 96 Units / Rail |
| NLV14504BDTG* | | |
| MC14504BDTR2G | TSSOP-16 (Pb-Free) | 2500 Units / Tape & Reel |
| NLV14504BDTR2G* | | |
| MC14504BFELG | SOEIAJ-16 (Pb-Free) | 2000 Units / Tape & Reel |

[†]For information on tape and reel specifications, including part orientation and tape sizes, please refer to our Tape and Reel Packaging Specifications Brochure, BRD8011/D.

*NLV Prefix for Automotive and Other Applications Requiring Unique Site and Control Change Requirements; AEC-Q100 Qualified and PPAP Capable.

MC14504B

ELECTRICAL CHARACTERISTICS (Voltages Referenced to V_{SS})

| Characteristic | Symbol | V_{CC} Vdc | V_{DD} Vdc | - 55°C | | 25°C | | | 125°C | | Unit |
|--|---------------------------|-----------------|-----------------|--------|-----------|-------|-----------------|-----------|-------|-----------|-----------------|
| | | | | Min | Max | Min | Typ (Note 2) | Max | Min | Max | |
| Output Voltage $V_{in} = 0\text{ V}$ $V_{in} = V_{CC}$ | "0" Level V_{OL} | - | 5.0 | - | 0.05 | - | 0 | 0.05 | - | 0.05 | Vdc |
| | | - | 10 | - | 0.05 | - | 0 | 0.05 | - | 0.05 | |
| | | - | 15 | - | 0.05 | - | 0 | 0.05 | - | 0.05 | |
| | "1" Level V_{OH} | - | 5.0 | 4.95 | - | 4.95 | 5.0 | - | 4.95 | - | Vdc |
| | | - | 10 | 9.95 | - | 9.95 | 10 | - | 9.95 | - | |
| | | - | 15 | 14.95 | - | 14.95 | 15 | - | 14.95 | - | |
| Input Voltage "0" Level ($V_{OL} = 1.0\text{ Vdc}$) TTL-CMOS ($V_{OL} = 1.5\text{ Vdc}$) TTL-CMOS ($V_{OL} = 1.0\text{ Vdc}$) CMOS-CMOS ($V_{OL} = 1.5\text{ Vdc}$) CMOS-CMOS ($V_{OL} = 1.5\text{ Vdc}$) CMOS-CMOS | V_{IL} | 5.0 | 10 | - | 0.8 | - | 1.3 | 0.8 | - | 0.8 | Vdc |
| | | 5.0 | 15 | - | 0.8 | - | 1.3 | 0.8 | - | 0.8 | |
| | | 5.0 | 10 | - | 1.5 | - | 2.25 | 1.5 | - | 1.4 | |
| | | 5.0 | 15 | - | 1.5 | - | 2.25 | 1.5 | - | 1.5 | |
| | | 10 | 15 | - | 3.0 | - | 4.5 | 3.0 | - | 2.9 | |
| | | 10 | 15 | - | 3.0 | - | 4.5 | 3.0 | - | 2.9 | |
| Input Voltage "1" Level ($V_{OH} = 9.0\text{ Vdc}$) TTL-CMOS ($V_{OH} = 13.5\text{ Vdc}$) TTL-CMOS ($V_{OH} = 9.0\text{ Vdc}$) CMOS-CMOS ($V_{OH} = 13.5\text{ Vdc}$) CMOS-CMOS ($V_{OH} = 13.5\text{ Vdc}$) CMOS-CMOS | V_{IH} | 5.0 | 10 | 2.0 | - | 2.0 | 1.5 | - | 2.0 | - | Vdc |
| | | 5.0 | 15 | 2.0 | - | 2.0 | 1.5 | - | 2.0 | - | |
| | | 5.0 | 10 | 3.6 | - | 3.5 | 2.75 | - | 3.5 | - | |
| | | 5.0 | 15 | 3.6 | - | 3.5 | 2.75 | - | 3.5 | - | |
| | | 10 | 15 | 7.1 | - | 7.0 | 5.5 | - | 7.0 | - | |
| | | 10 | 15 | 7.1 | - | 7.0 | 5.5 | - | 7.0 | - | |
| Output Drive Current ($V_{OH} = 2.5\text{ Vdc}$) ($V_{OH} = 4.6\text{ Vdc}$) ($V_{OH} = 9.5\text{ Vdc}$) ($V_{OH} = 13.5\text{ Vdc}$) ($V_{OL} = 0.4\text{ Vdc}$) ($V_{OL} = 0.5\text{ Vdc}$) ($V_{OL} = 1.5\text{ Vdc}$) | Source I_{OH} | - | 5.0 | -3.0 | - | -2.4 | -4.2 | - | -1.7 | - | mAdc |
| | | - | 5.0 | -0.64 | - | -0.51 | -0.88 | - | -0.36 | - | |
| | | - | 10 | -1.6 | - | -1.3 | -2.25 | - | -0.9 | - | |
| | | - | 15 | -4.2 | - | -3.4 | -8.8 | - | -2.4 | - | |
| | Sink I_{OL} | - | 5.0 | 0.64 | - | 0.51 | 0.88 | - | 0.36 | - | mAdc |
| | | - | 10 | 1.6 | - | 1.3 | 2.25 | - | 0.9 | - | |
| Input Current | I_{in} | - | 15 | - | ± 0.1 | - | ± 0.00001 | ± 0.1 | - | ± 1.0 | μAdc |
| Input Capacitance ($V_{in} = 0$) | C_{in} | - | - | - | - | - | 5.0 | 7.5 | - | - | pF |
| Quiescent Current (Per Package) CMOS-CMOS Mode | I_{DD} or I_{CC} | - | 5.0 | - | 0.05 | - | 0.0005 | 0.05 | - | 1.5 | μAdc |
| | | - | 10 | - | 0.10 | - | 0.0010 | 0.10 | - | 3.0 | |
| | | - | 15 | - | 0.20 | - | 0.0015 | 0.20 | - | 6.0 | |
| Quiescent Current (Per Package) TTL-CMOS Mode | I_{DD} | 5.0 | 5.0 | - | 0.5 | - | 0.0005 | 0.5 | - | 3.8 | μAdc |
| | | 5.0 | 10 | - | 1.0 | - | 0.0010 | 1.0 | - | 7.5 | |
| | | 5.0 | 15 | - | 2.0 | - | 0.0015 | 2.0 | - | 15 | |
| Quiescent Current (Per Package) TTL-CMOS Mode | I_{CC} | 5.0 | 5.0 | - | 5.0 | - | 2.5 | 5.0 | - | 6.0 | mAdc |
| | | 5.0 | 10 | - | 5.0 | - | 2.5 | 5.0 | - | 6.0 | |
| | | 5.0 | 15 | - | 5.0 | - | 2.5 | 5.0 | - | 6.0 | |

Product parametric performance is indicated in the Electrical Characteristics for the listed test conditions, unless otherwise noted. Product performance may not be indicated by the Electrical Characteristics if operated under different conditions.

2. Data labelled "Typ" is not to be used for design purposes but is intended as an indication of the IC's potential performance.

MC14504B

SWITCHING CHARACTERISTICS ($C_L = 50 \text{ pF}$, $T_A = 25^\circ\text{C}$)

| Characteristic | Symbol | Shifting Mode | V_{CC} Vdc | V_{DD} Vdc | Limits | | | Unit |
|----------------------------------|-----------------------|----------------------------------|-----------------|-----------------|--------|-----------------|-----|------|
| | | | | | Min | Typ (Note 3) | Max | |
| Propagation Delay, High to Low | t_{PHL} | TTL – CMOS $V_{DD} > V_{CC}$ | 5.0 | 10 | – | 140 | 280 | ns |
| | | | 5.0 | 15 | – | 140 | 280 | |
| | | CMOS – CMOS $V_{DD} > V_{CC}$ | 5.0 | 10 | – | 120 | 240 | |
| | | | 5.0 | 15 | – | 120 | 240 | |
| | | CMOS – CMOS $V_{CC} > V_{DD}$ | 10 | 5.0 | – | 185 | 370 | |
| | | | 15 | 5.0 | – | 185 | 370 | |
| CMOS – CMOS $V_{CC} > V_{DD}$ | 15 | 10 | – | 175 | 350 | | | |
| | 15 | 10 | – | 175 | 350 | | | |
| Propagation Delay, Low to High | t_{PLH} | TTL – CMOS $V_{DD} > V_{CC}$ | 5.0 | 10 | – | 170 | 340 | ns |
| | | | 5.0 | 15 | – | 160 | 320 | |
| | | CMOS – CMOS $V_{DD} > V_{CC}$ | 5.0 | 10 | – | 170 | 340 | |
| | | | 5.0 | 15 | – | 170 | 340 | |
| | | CMOS – CMOS $V_{CC} > V_{DD}$ | 10 | 5.0 | – | 100 | 200 | |
| | | | 15 | 5.0 | – | 100 | 200 | |
| | | CMOS – CMOS $V_{CC} > V_{DD}$ | 15 | 5.0 | – | 275 | 550 | |
| | | | 15 | 5.0 | – | 275 | 550 | |
| | | CMOS – CMOS $V_{CC} > V_{DD}$ | 15 | 10 | – | 145 | 290 | |
| 15 | 10 | | – | 145 | 290 | | | |
| Output Rise and Fall Time | t_{TLH} , t_{THL} | ALL | – | 5.0 | – | 100 | 200 | ns |
| | | | – | 10 | – | 50 | 100 | |
| | | | – | 15 | – | 40 | 80 | |

3. Data labelled "Typ" is not to be used for design purposes but is intended as an indication of the IC's potential performance.

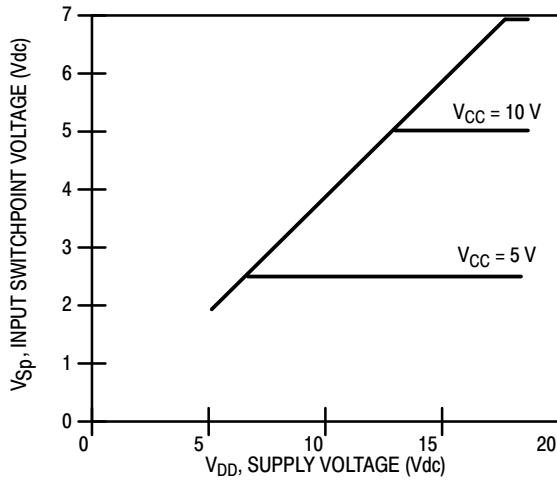

Figure 1. Input Switchpoint CMOS to CMOS Mode

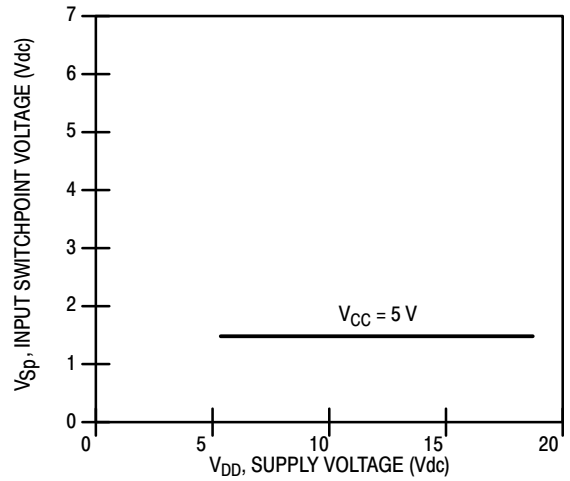

Figure 2. Input Switchpoint TTL to CMOS Mode

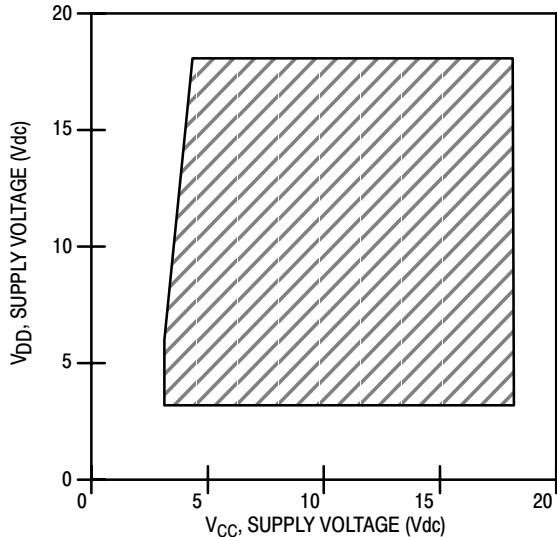

Figure 3. Operating Boundary CMOS to CMOS Mode

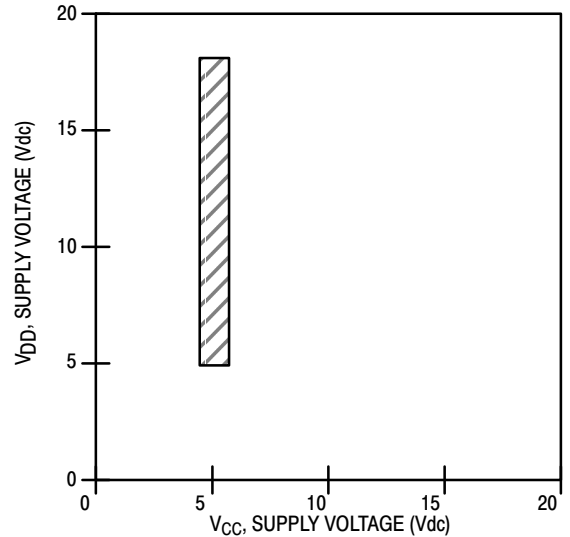
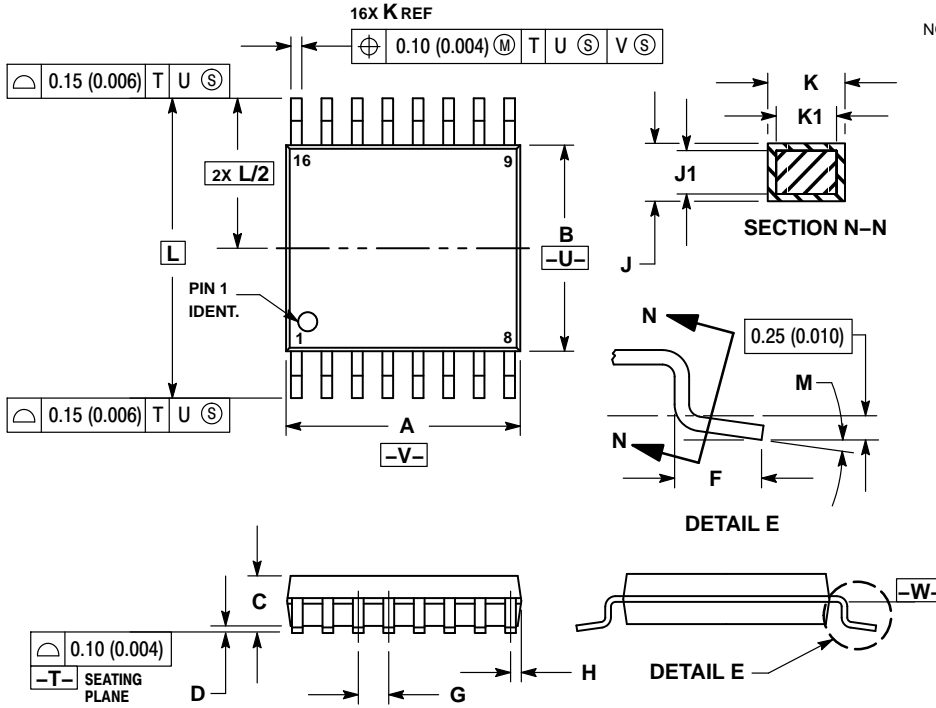

Figure 4. Operating Boundary TTL to CMOS Mode

MC14504B

PACKAGE DIMENSIONS

TSSOP-16
DT SUFFIX
PLASTIC TSSOP PACKAGE
CASE 948F
ISSUE B



- NOTES:
1. DIMENSIONING AND TOLERANCING PER ANSI Y14.5M, 1982.
 2. CONTROLLING DIMENSION: MILLIMETER.
 3. DIMENSION A DOES NOT INCLUDE MOLD FLASH. PROTRUSIONS OR GATE BURRS. MOLD FLASH OR GATE BURRS SHALL NOT EXCEED 0.15 (0.006) PER SIDE.
 4. DIMENSION B DOES NOT INCLUDE INTERLEAD FLASH OR PROTRUSION. INTERLEAD FLASH OR PROTRUSION SHALL NOT EXCEED 0.25 (0.010) PER SIDE.
 5. DIMENSION K DOES NOT INCLUDE DAMBAR PROTRUSION. ALLOWABLE DAMBAR PROTRUSION SHALL BE 0.08 (0.003) TOTAL IN EXCESS OF THE K DIMENSION AT MAXIMUM MATERIAL CONDITION.
 6. TERMINAL NUMBERS ARE SHOWN FOR REFERENCE ONLY.
 7. DIMENSION A AND B ARE TO BE DETERMINED AT DATUM PLANE -W-.

SOLDERING FOOTPRINT

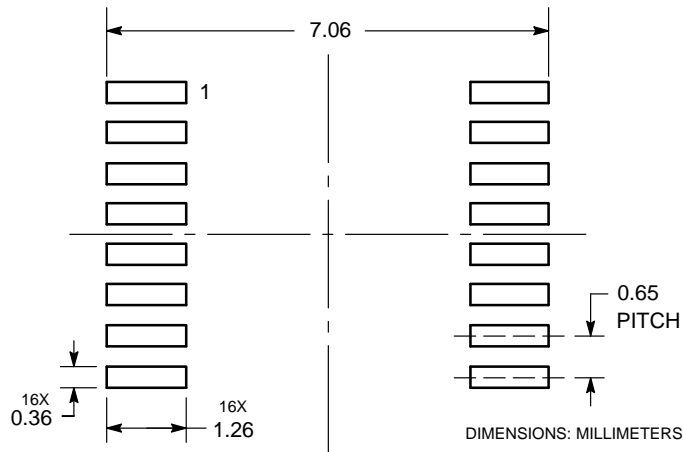

MC14504B

PACKAGE DIMENSIONS

SOIC-16
D SUFFIX
PLASTIC SOIC PACKAGE
CASE 751B-05
ISSUE K

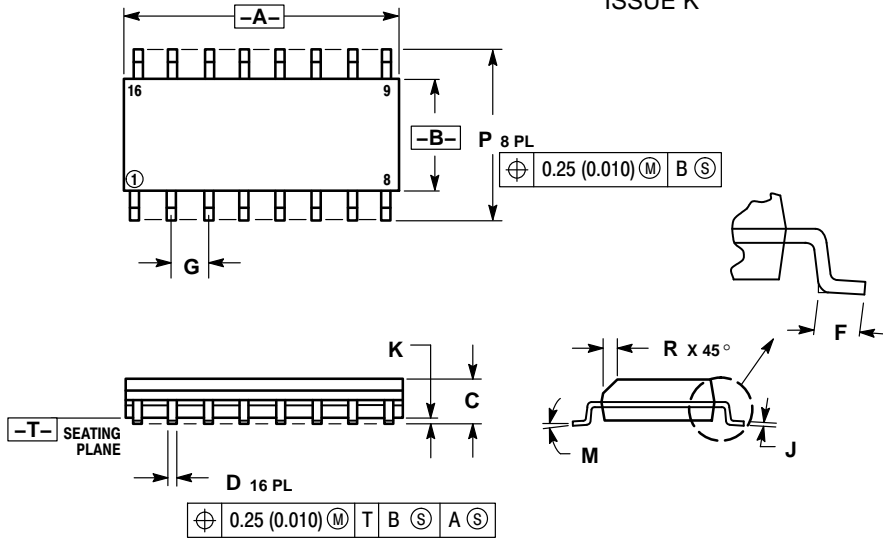

NOTES:

1. DIMENSIONING AND TOLERANCING PER ANSI Y14.5M, 1982.
2. CONTROLLING DIMENSION: MILLIMETER.
3. DIMENSIONS A AND B DO NOT INCLUDE MOLD PROTRUSION.
4. MAXIMUM MOLD PROTRUSION 0.15 (0.006) PER SIDE.
5. DIMENSION D DOES NOT INCLUDE DAMBAR PROTRUSION. ALLOWABLE DAMBAR PROTRUSION SHALL BE 0.127 (0.005) TOTAL IN EXCESS OF THE D DIMENSION AT MAXIMUM MATERIAL CONDITION.

| DIM | MILLIMETERS | | INCHES | |
|-----|-------------|-------|-----------|-------|
| | MIN | MAX | MIN | MAX |
| A | 9.80 | 10.00 | 0.386 | 0.393 |
| B | 3.80 | 4.00 | 0.150 | 0.157 |
| C | 1.35 | 1.75 | 0.054 | 0.068 |
| D | 0.35 | 0.49 | 0.014 | 0.019 |
| F | 0.40 | 1.25 | 0.016 | 0.049 |
| G | 1.27 BSC | | 0.050 BSC | |
| J | 0.19 | 0.25 | 0.008 | 0.009 |
| K | 0.10 | 0.25 | 0.004 | 0.009 |
| M | 0° - 7° | | 0° - 7° | |
| P | 5.80 | 6.20 | 0.229 | 0.244 |
| R | 0.25 | 0.50 | 0.010 | 0.019 |

SOLDERING FOOTPRINT

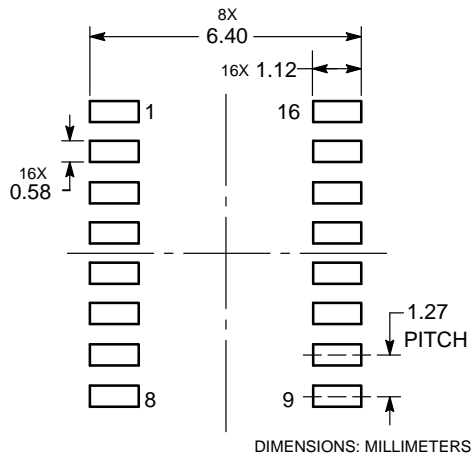

MC14504B

PACKAGE DIMENSIONS

SOEIAJ-16 F SUFFIX PLASTIC EIAJ SOIC PACKAGE CASE 966 ISSUE A

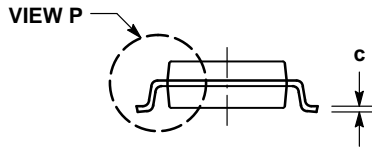
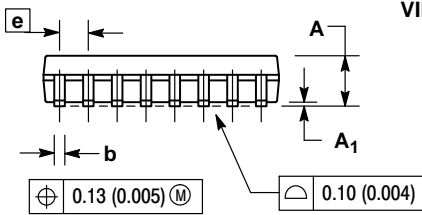
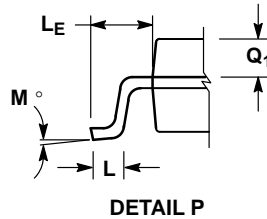
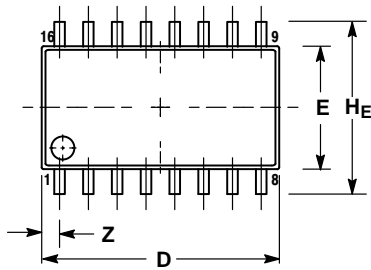

NOTES:

1. DIMENSIONING AND TOLERANCING PER ANSI Y14.5M, 1982.
2. CONTROLLING DIMENSION: MILLIMETER.
3. DIMENSIONS D AND E DO NOT INCLUDE MOLD FLASH OR PROTRUSIONS AND ARE MEASURED AT THE PARTING LINE. MOLD FLASH OR PROTRUSIONS SHALL NOT EXCEED 0.15 (0.006) PER SIDE.
4. TERMINAL NUMBERS ARE SHOWN FOR REFERENCE ONLY.
5. THE LEAD WIDTH DIMENSION (b) DOES NOT INCLUDE DAMBAR PROTRUSION. ALLOWABLE DAMBAR PROTRUSION SHALL BE 0.08 (0.003) TOTAL IN EXCESS OF THE LEAD WIDTH DIMENSION AT MAXIMUM MATERIAL CONDITION. DAMBAR CANNOT BE LOCATED ON THE LOWER RADIUS OR THE FOOT. MINIMUM SPACE BETWEEN PROTRUSIONS AND ADJACENT LEAD TO BE 0.46 (0.018).

| DIM | MILLIMETERS | | INCHES | |
|----------------|-------------|-------|-----------|-------|
| | MIN | MAX | MIN | MAX |
| A | --- | 2.05 | --- | 0.081 |
| A ₁ | 0.05 | 0.20 | 0.002 | 0.008 |
| b | 0.35 | 0.50 | 0.014 | 0.020 |
| c | 0.10 | 0.20 | 0.007 | 0.011 |
| D | 9.90 | 10.50 | 0.390 | 0.413 |
| E | 5.10 | 5.45 | 0.201 | 0.215 |
| e | 1.27 BSC | | 0.050 BSC | |
| HE | 7.40 | 8.20 | 0.291 | 0.323 |
| L | 0.50 | 0.85 | 0.020 | 0.033 |
| LE | 1.10 | 1.50 | 0.043 | 0.059 |
| M | 0° | 10° | 0° | 10° |
| Q ₁ | 0.70 | 0.90 | 0.028 | 0.035 |
| Z | --- | 0.78 | --- | 0.031 |

ON Semiconductor and the  are registered trademarks of Semiconductor Components Industries, LLC (SCILLC) or its subsidiaries in the United States and/or other countries. SCILLC owns the rights to a number of patents, trademarks, copyrights, trade secrets, and other intellectual property. A listing of SCILLC's product/patent coverage may be accessed at www.onsemi.com/site/pdf/Patent-Marking.pdf. SCILLC reserves the right to make changes without further notice to any products herein. SCILLC makes no warranty, representation or guarantee regarding the suitability of its products for any particular purpose, nor does SCILLC assume any liability arising out of the application or use of any product or circuit, and specifically disclaims any and all liability, including without limitation special, consequential or incidental damages. "Typical" parameters which may be provided in SCILLC data sheets and/or specifications can and do vary in different applications and actual performance may vary over time. All operating parameters, including "Typicals" must be validated for each customer application by customer's technical experts. SCILLC does not convey any license under its patent rights nor the rights of others. SCILLC products are not designed, intended, or authorized for use as components in systems intended for surgical implant into the body, or other applications intended to support or sustain life, or for any other application in which the failure of the SCILLC product could create a situation where personal injury or death may occur. Should Buyer purchase or use SCILLC products for any such unintended or unauthorized application, Buyer shall indemnify and hold SCILLC and its officers, employees, subsidiaries, affiliates, and distributors harmless against all claims, costs, damages, and expenses, and reasonable attorney fees arising out of, directly or indirectly, any claim of personal injury or death associated with such unintended or unauthorized use, even if such claim alleges that SCILLC was negligent regarding the design or manufacture of the part. SCILLC is an Equal Opportunity/Affirmative Action Employer. This literature is subject to all applicable copyright laws and is not for resale in any manner.

PUBLICATION ORDERING INFORMATION

LITERATURE FULFILLMENT:

Literature Distribution Center for ON Semiconductor
P.O. Box 5163, Denver, Colorado 80217 USA
Phone: 303-675-2175 or 800-344-3860 Toll Free USA/Canada
Fax: 303-675-2176 or 800-344-3867 Toll Free USA/Canada
Email: orderlit@onsemi.com

N. American Technical Support: 800-282-9855 Toll Free
USA/Canada
Europe, Middle East and Africa Technical Support:
Phone: 421 33 790 2910
Japan Customer Focus Center
Phone: 81-3-5817-1050

ON Semiconductor Website: www.onsemi.com

Order Literature: <http://www.onsemi.com/orderlit>

For additional information, please contact your local Sales Representative