

MAXIM

Quad LVDS Line Driver with Flow-Through Pinout

MAX9123

General Description

The MAX9123 quad low-voltage differential signaling (LVDS) differential line driver is ideal for applications requiring high data rates, low power, and low noise. The MAX9123 is guaranteed to transmit data at speeds up to 800Mbps (400MHz) over controlled impedance media of approximately 100Ω. The transmission media may be printed circuit (PC) board traces, backplanes, or cables.

The MAX9123 accepts four LVTTTL/LVCMOS input levels and translates them to LVDS output signals. Moreover, the MAX9123 is capable of setting all four outputs to a high-impedance state through two enable inputs, EN and $\overline{\text{EN}}$, thus dropping the device to an ultra-low-power state of 16mW (typ) during high impedance. The enables are common to all four transmitters. Outputs conform to the ANSI TIA/EIA-644 LVDS standard. Flow-through pinout simplifies PC board layout and reduces crosstalk by separating the LVTTTL/LVCMOS inputs and LVDS outputs.

The MAX9123 operates from a single +3.3V supply and is specified for operation from -40°C to +85°C. It is available in 16-pin TSSOP and SO packages. Refer to the MAX9121/MAX9122* data sheet for quad LVDS line receivers with integrated termination and flow-through pinout.

Applications

- | | |
|--------------------------|--------------------------|
| Digital Copiers | DSLAMs |
| Laser Printers | Network Switches/Routers |
| Cell Phone Base Stations | Backplane Interconnect |
| Add Drop Muxes | Clock Distribution |
| Digital Cross-Connects | |

Pin Configuration

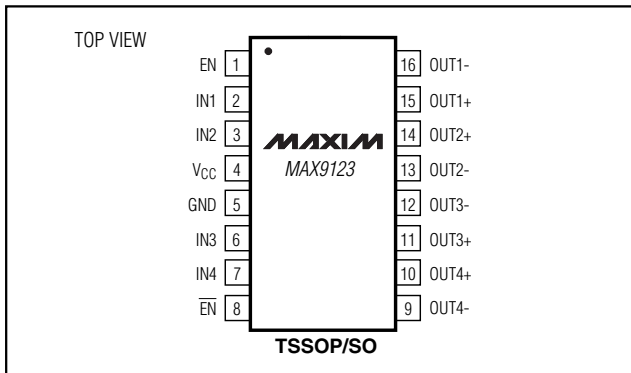

* Future product—contact factory for availability.

Features

- ◆ Flow-Through Pinout
Simplifies PC Board Layout
Reduces Crosstalk
- ◆ Pin Compatible with DS90LV047A
- ◆ Guaranteed 800Mbps Data Rate
- ◆ 250ps Maximum Pulse Skew
- ◆ Conforms to TIA/EIA-644 LVDS Standard
- ◆ Single +3.3V Supply
- ◆ 16-Pin TSSOP and SO Packages

Ordering Information

| PART | TEMP. RANGE | PIN-PACKAGE |
|------------|----------------|-------------|
| MAX9123EUE | -40°C to +85°C | 16 TSSOP |
| MAX9123ESE | -40°C to +85°C | 16 SO |

Typical Applications Circuit

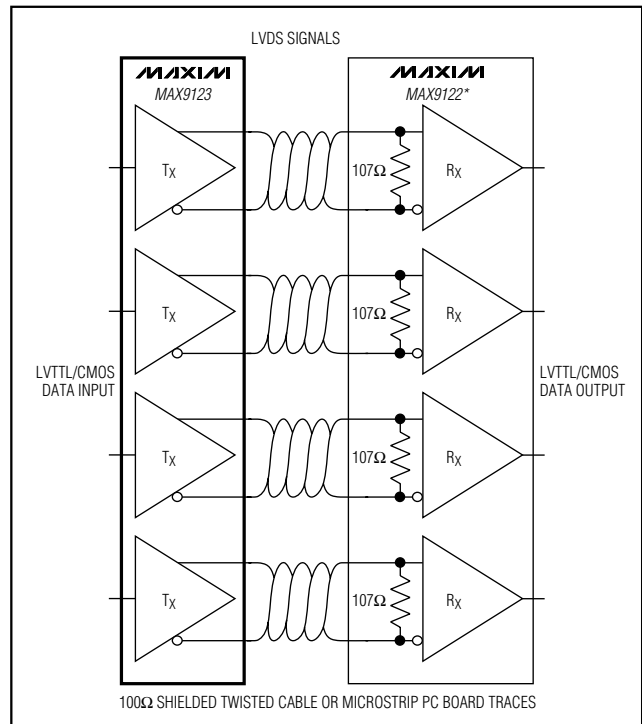

Quad LVDS Line Driver with Flow-Through Pinout

ABSOLUTE MAXIMUM RATINGS

| | |
|---|-----------------------------------|
| V _{CC} to GND | -0.3V to +4.0V |
| IN ₋ , EN, $\overline{\text{EN}}$ to GND | -0.3V to (V _{CC} + 0.3V) |
| OUT ₊ , OUT ₋ to GND | -0.3V to +3.9V |
| Short-Circuit Duration (OUT ₊ , OUT ₋) | Continuous |
| Continuous Power Dissipation (T _A = +70°C) | |
| 16-Pin TSSOP (derate 9.4mW/°C above +70°C) | 755mW |
| 16-Pin SO (derate 8.7mW/°C above +70°C) | 696mW |

| | |
|---|-----------------|
| Storage Temperature Range | -65°C to +150°C |
| Maximum Junction Temperature | +150°C |
| Operating Temperature Range | -40°C to +85°C |
| Lead Temperature (soldering, 10s) | +300°C |
| ESD Protection | |
| Human Body Model, IN ₋ , OUT ₊ , OUT ₋ | ±4kV |

Stresses beyond those listed under "Absolute Maximum Ratings" may cause permanent damage to the device. These are stress ratings only, and functional operation of the device at these or any other conditions beyond those indicated in the operational sections of the specifications is not implied. Exposure to absolute maximum rating conditions for extended periods may affect device reliability.

DC ELECTRICAL CHARACTERISTICS

(V_{CC} = +3.0V to +3.6V, R_L = 100Ω ±1%, T_A = -40°C to +85°C. Typical values are at V_{CC} = +3.3V, T_A = +25°C, unless otherwise noted.) (Notes 1, 2)

| PARAMETER | SYMBOL | CONDITIONS | MIN | TYP | MAX | UNITS |
|--|------------------|--|-------|------|-----------------|-------|
| LVDS OUTPUT (OUT₊, OUT₋) | | | | | | |
| Differential Output Voltage | V _{OD} | Figure 1 | 250 | 368 | 450 | mV |
| Change in Magnitude of V _{OD} Between Complementary Output States | ΔV _{OD} | Figure 1 | | 1 | 35 | mV |
| Offset Voltage | V _{OS} | Figure 1 | 1.125 | 1.25 | 1.375 | V |
| Change in Magnitude of V _{OS} Between Complementary Output States | ΔV _{OS} | Figure 1 | | 4 | 25 | mV |
| Output High Voltage | V _{OH} | | | | 1.6 | V |
| Output Low Voltage | V _{OL} | | 0.90 | | | V |
| Differential Output Short-Circuit Current (Note 3) | I _{OSD} | Enabled, V _{OD} = 0 | | | -9 | mA |
| Output Short-Circuit Current | I _{OS} | OUT ₊ = 0 at IN ₋ = V _{CC} or OUT ₋ = 0 at IN ₋ = 0, enabled | | -3.8 | -9 | mA |
| Output High-Impedance Current | I _{OZ} | EN = low and $\overline{\text{EN}}$ = high, OUT ₊ = 0 or V _{CC} , OUT ₋ = 0 or V _{CC} , R _L = ∞ | -10 | | 10 | μA |
| Power-Off Output Current | I _{OFF} | V _{CC} = 0 or open, OUT ₊ = 0 or 3.6V, OUT ₋ = 0 or 3.6V, R _L = ∞ | -20 | | 20 | μA |
| INPUTS (IN₋, EN, $\overline{\text{EN}}$) | | | | | | |
| High-Level Input Voltage | V _{IH} | | 2.0 | | V _{CC} | V |
| Low-Level Input Voltage | V _{IL} | | GND | | 0.8 | V |
| Input Current | I _{IN} | IN ₋ , EN, $\overline{\text{EN}}$ = 0 or V _{CC} | -20 | | 20 | μA |
| SUPPLY CURRENT | | | | | | |
| No-Load Supply Current | I _{CC} | R _L = ∞, IN ₋ = V _{CC} or 0 for all channels | | 9.2 | 11 | mA |
| Loaded Supply Current | I _{CCL} | R _L = 100Ω, IN ₋ = V _{CC} or 0 for all channels | | 22.7 | 30 | mA |
| Disabled Supply Current | I _{CCZ} | Disabled, IN ₋ = V _{CC} or 0 for all channels, EN = 0, $\overline{\text{EN}}$ = V _{CC} | | 4.9 | 6 | mA |

Quad LVDS Line Driver with Flow-Through Pinout

MAX9123

SWITCHING CHARACTERISTICS

($V_{CC} = +3.0V$ to $+3.6V$, $R_L = 100\Omega \pm 1\%$, $C_L = 15pF$, $T_A = -40^\circ C$ to $+85^\circ C$. Typical values are at $V_{CC} = +3.3V$, $T_A = +25^\circ C$, unless otherwise noted.) (Notes 4, 5, 6)

| PARAMETER | SYMBOL | CONDITIONS | MIN | TYP | MAX | UNITS |
|---|--------|-----------------|-----|------|------|-------|
| Differential Propagation Delay High to Low | tPHLD | Figures 2 and 3 | 0.7 | | 1.7 | ns |
| Differential Propagation Delay Low to High | tPLHD | Figures 2 and 3 | 0.7 | | 1.7 | ns |
| Differential Pulse Skew (Note 7) | tSKD1 | Figures 2 and 3 | | 0.04 | 0.25 | ns |
| Differential Channel-to-Channel Skew (Note 8) | tSKD2 | Figures 2 and 3 | | 0.07 | 0.35 | ns |
| Differential Part-to-Part Skew (Note 9) | tSKD3 | Figures 2 and 3 | | 0.13 | 0.8 | ns |
| Differential Part-to-Part Skew (Note 10) | tSKD4 | Figures 2 and 3 | | 0.43 | 1.0 | ns |
| Rise Time | tTLH | Figures 2 and 3 | 0.2 | 0.39 | 1.0 | ns |
| Fall Time | tTHL | Figures 2 and 3 | 0.2 | 0.39 | 1.0 | ns |
| Disable Time High to Z | tPHZ | Figures 4 and 5 | | 2.7 | 5 | ns |
| Disable Time Low to Z | tPLZ | Figures 4 and 5 | | 2.7 | 5 | ns |
| Enable Time Z to High | tPZH | Figures 4 and 5 | | 2.3 | 7 | ns |
| Enable Time Z to Low | tPZL | Figures 4 and 5 | | 2.3 | 7 | ns |
| Maximum Operating Frequency (Note 11) | fMAX | | 400 | | | MHz |

Note 1: Maximum and minimum limits over temperature are guaranteed by design and characterization. Devices are 100% tested at $T_A = +25^\circ C$.

Note 2: Currents into the device are positive, and current out of the device is negative. All voltages are referenced to ground except V_{OD} .

Note 3: Guaranteed by correlation data.

Note 4: AC parameters are guaranteed by design and characterization.

Note 5: C_L includes probe and jig capacitance.

Note 6: Signal generator conditions for dynamic tests: $V_{OL} = 0$, $V_{OH} = 3V$, $f = 100MHz$, 50% duty cycle, $R_O = 50\Omega$, $t_R \leq 1ns$, $t_F \leq 1ns$ (0% to 100%).

Note 7: tSKD1 is the magnitude difference of differential propagation delay. $t_{SKD1} = |t_{PHLD} - t_{PLHD}|$.

Note 8: tSKD2 is the magnitude difference of tPHLD or tPLHD of one channel to the tPHLD or tPLHD of another channel on the same device.

Note 9: tSKD3 is the magnitude difference of any differential propagation delays between devices at the same V_{CC} and within $5^\circ C$ of each other.

Note 10: tSKD4 is the magnitude difference of any differential propagation delays between devices operating over the rated supply and temperature ranges.

Note 11: fMAX signal generator conditions: $V_{OL} = 0$, $V_{OH} = 3V$, $f = 400MHz$, 50% duty cycle, $R_O = 50\Omega$, $t_R \leq 1ns$, $t_F \leq 1ns$ (0% to 100%). Transmitter output criteria: duty cycle = 45% to 55%, $V_{OD} \geq 250mV$.

Quad LVDS Line Driver with Flow-Through Pinout

Typical Operating Characteristics

($V_{CC} = +3.3V$, $R_L = 100\Omega$, $C_L = 15pF$, $T_A = +25^\circ C$, unless otherwise noted.)

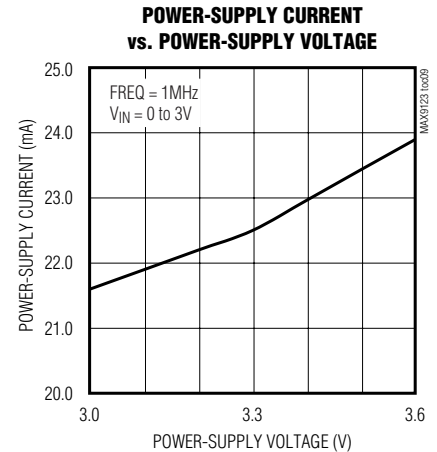
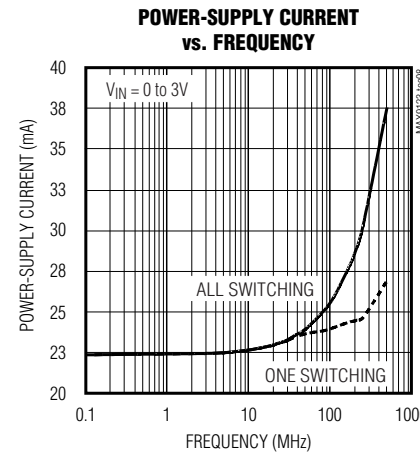
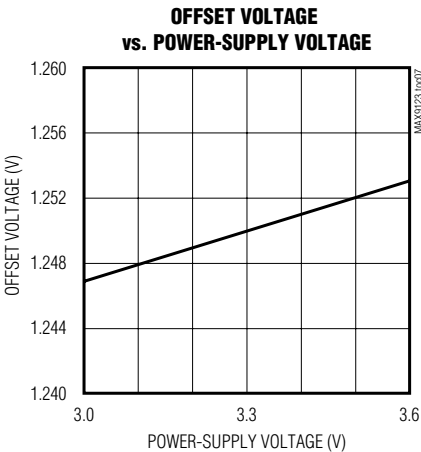
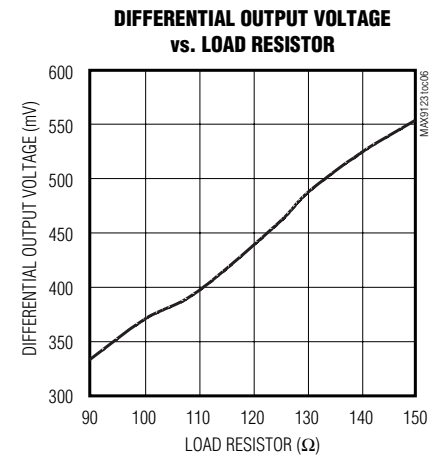
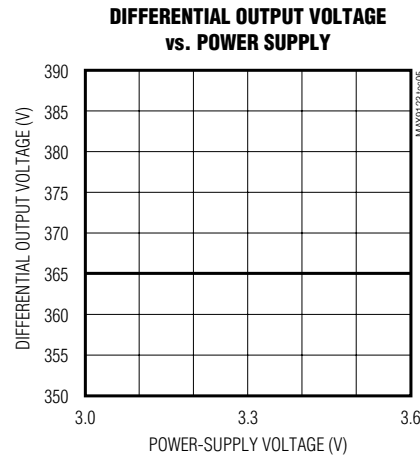
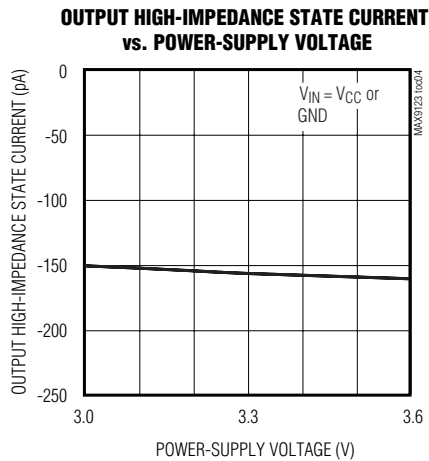
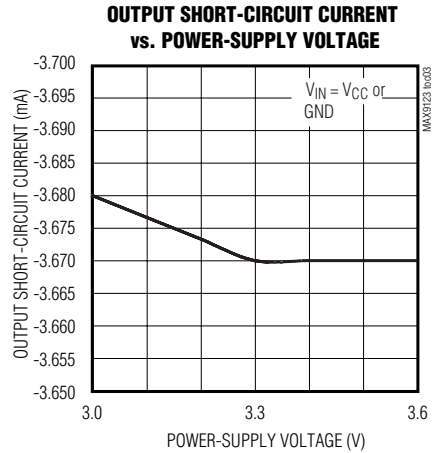
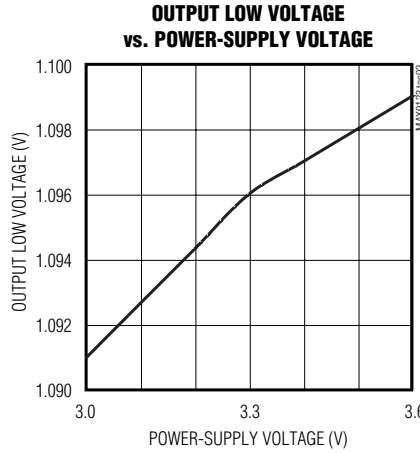
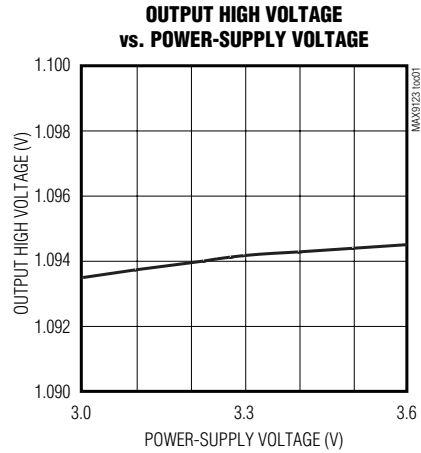

Quad LVDS Line Driver with Flow-Through Pinout

MAX9123

Typical Operating Characteristics (continued)

($V_{CC} = +3.3V$, $R_L = 100\Omega$, $C_L = 15pF$, $T_A = +25^\circ C$, unless otherwise noted.)

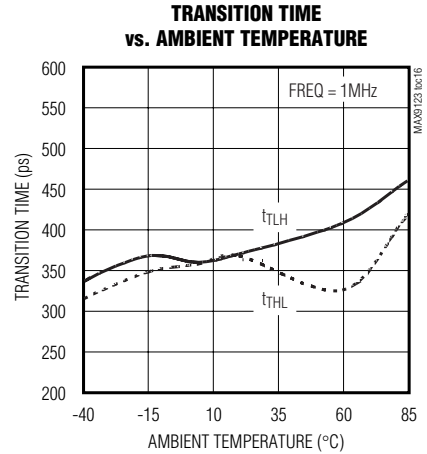
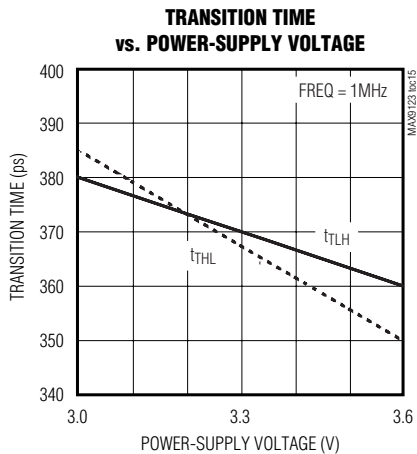
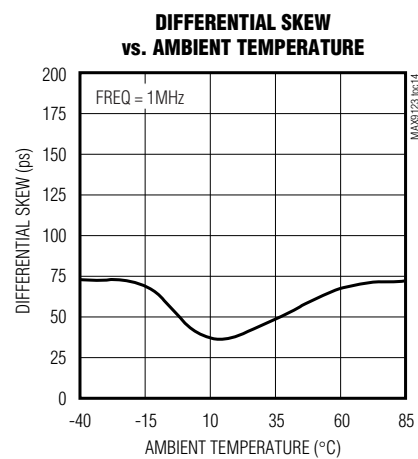
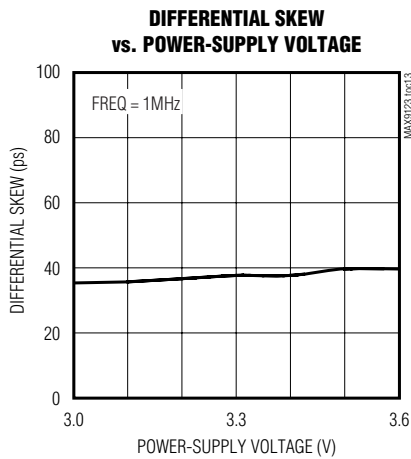
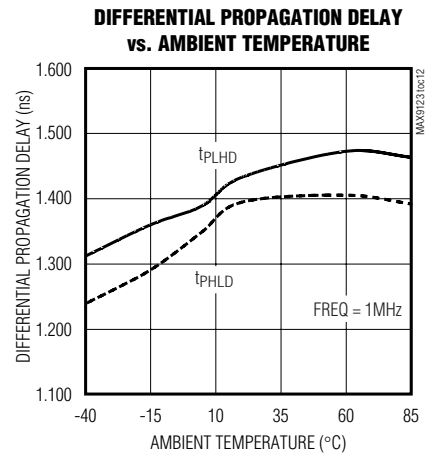
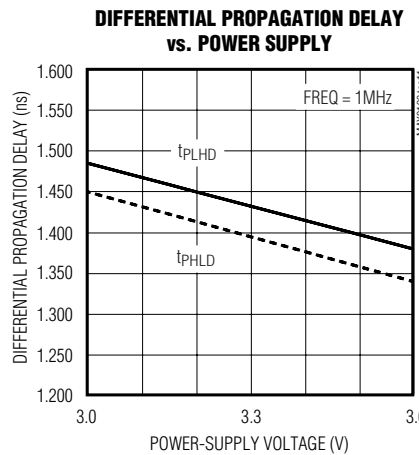
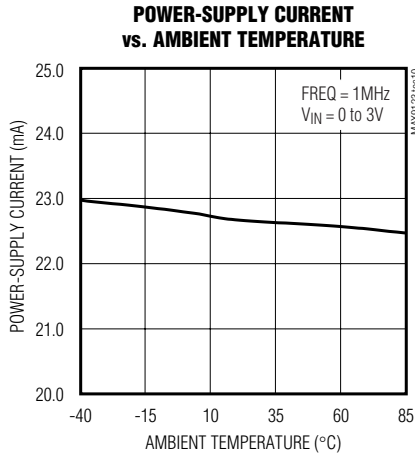

Quad LVDS Line Driver with Flow-Through Pinout

Pin Description

| PIN | NAME | FUNCTION |
|----------------|-----------------|---|
| 1 | EN | Driver Enable Input. The driver is disabled when EN is low. EN is internally pulled down. When EN = high and \overline{EN} = low or open, the outputs are active. For other combinations of EN and \overline{EN} , the outputs are disabled and are high impedance. |
| 2, 3, 6, 7 | IN_ | LVTTTL/LVCMOS Driver Inputs |
| 4 | V _{CC} | Power-Supply Input. Bypass V _{CC} to GND with 0.1 μ F and 0.001 μ F ceramic capacitors. |
| 5 | GND | Ground |
| 8 | \overline{EN} | Driver Enable Input. The transmitter is disabled when \overline{EN} is high. \overline{EN} is internally pulled down. |
| 9, 12, 13, 16 | OUT_- | Inverting LVDS Driver Outputs |
| 10, 11, 14, 15 | OUT_+ | Noninverting LVDS Driver Outputs |

Detailed Description

The LVDS interface standard is a signaling method intended for point-to-point communication over a controlled-impedance medium as defined by the ANSI/TIA/EIA-644 and IEEE 1596.3 standards. The LVDS standard uses a lower voltage swing than other common communication standards, achieving higher data rates with reduced power consumption while reducing EMI emissions and system susceptibility to noise.

The MAX9123 is an 800Mbps quad differential LVDS driver that is designed for high-speed, point-to-point, and low-power applications. This device accepts LVTTTL/LVCMOS input levels and translates them to LVDS output signals.

The MAX9123 generates a 2.5mA to 4.0mA output current using a current-steering configuration. This current-steering approach induces less ground bounce and no shoot-through current, enhancing noise margin and system speed performance. The driver outputs are short-circuit current limited, and enter a high-impedance state when the device is not powered or is disabled.

The current-steering architecture of the MAX9123 requires a resistive load to terminate the signal and complete the transmission loop. Because the device switches current and not voltage, the actual output voltage swing is determined by the value of the termination resistor at the input of an LVDS receiver. Logic states are determined by the direction of current flow through the termination resistor. With a typical 3.7mA output current, the MAX9123 produces an output voltage of 370mV when driving a 100 Ω load.

Termination

Because the MAX9123 is a current-steering device, no output voltage will be generated without a termination resistor. The termination resistors should match the differential impedance of the transmission line. Output voltage levels depend upon the value of the termination resistor. The MAX9123 is optimized for point-to-point interface with 100 Ω termination resistors at the receiver inputs. Termination resistance values may range between 90 Ω and 132 Ω , depending on the characteristic impedance of the transmission medium.

Table 1. Input/Output Function Table

| ENABLES | | INPUTS | OUTPUTS | |
|---------------------------------------|-----------------|------------|---------|-------|
| EN | \overline{EN} | IN_ | OUT_+ | OUT_- |
| H | L or open | L | L | H |
| H | L or open | H | H | L |
| All other combinations of ENABLE pins | | Don't care | Z | Z |

Applications Information

Power-Supply Bypassing

Bypass V_{CC} with high-frequency, surface-mount ceramic 0.1 μ F and 0.001 μ F capacitors in parallel as close to the device as possible, with the smaller valued capacitor closest to V_{CC}.

Differential Traces

Output trace characteristics affect the performance of the MAX9123. Use controlled-impedance traces to match trace impedance to the transmission medium.

Quad LVDS Line Driver with Flow-Through Pinout

MAX9123

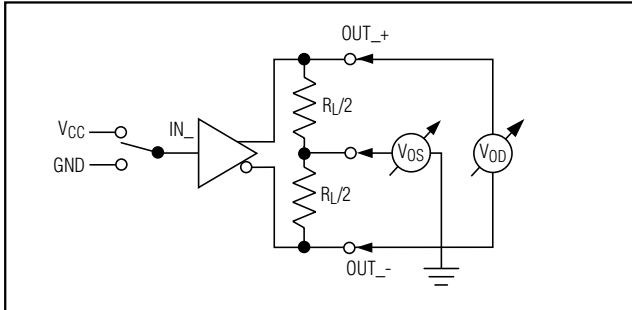

Figure 1. Driver V_{OD} and V_{OS} Test Circuit

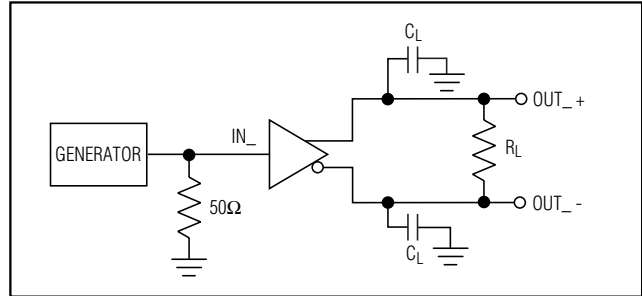

Figure 2. Driver Propagation Delay and Transition Time Test Circuit

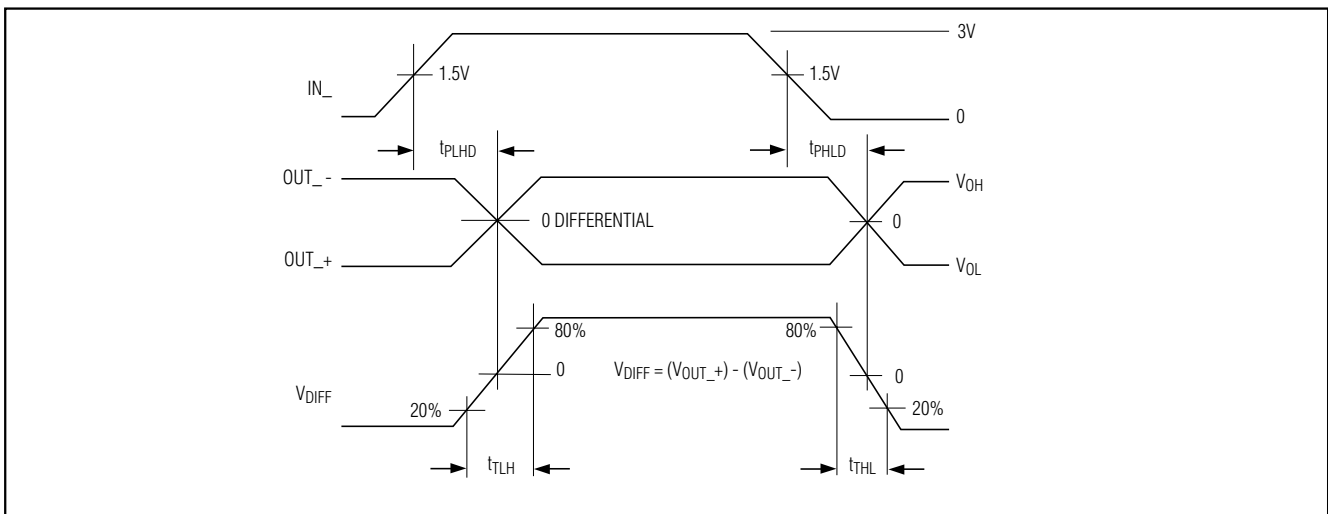

Figure 3. Driver Propagation Delay and Transition Time Waveforms

Eliminate reflections and ensure that noise couples as common mode by running the differential trace pairs close together. Reduce skew by matching the electrical length of the traces. Excessive skew can result in a degradation of magnetic field cancellation.

Maintain the distance between the differential traces to avoid discontinuities in differential impedance. Avoid 90° turns and minimize the number of vias to further prevent impedance discontinuities.

Cables and Connectors

Transmission media should have a nominal differential impedance of 100Ω. To minimize impedance discontinuities, use cables and connectors that have matched differential impedance.

Avoid the use of unbalanced cables such as ribbon or simple coaxial cable. Balanced cables such as twisted pair offer superior signal quality and tend to generate

less EMI due to canceling effects. Balanced cables tend to pick up noise as common mode, which is rejected by the LVDS receiver.

Board Layout

For LVDS applications, a four-layer PC board that provides separate power, ground, LVDS signals, and input signals is recommended. Isolate the LVTTTL/LVCMOS and LVDS signals from each other to prevent coupling.

Chip Information

TRANSISTOR COUNT: 1246

PROCESS: CMOS

Quad LVDS Line Driver with Flow-Through Pinout

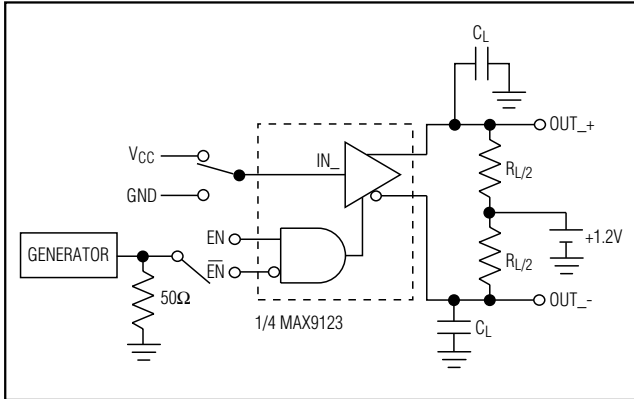

Figure 4. Driver High-Impedance Delay Test Circuit

Functional Diagram

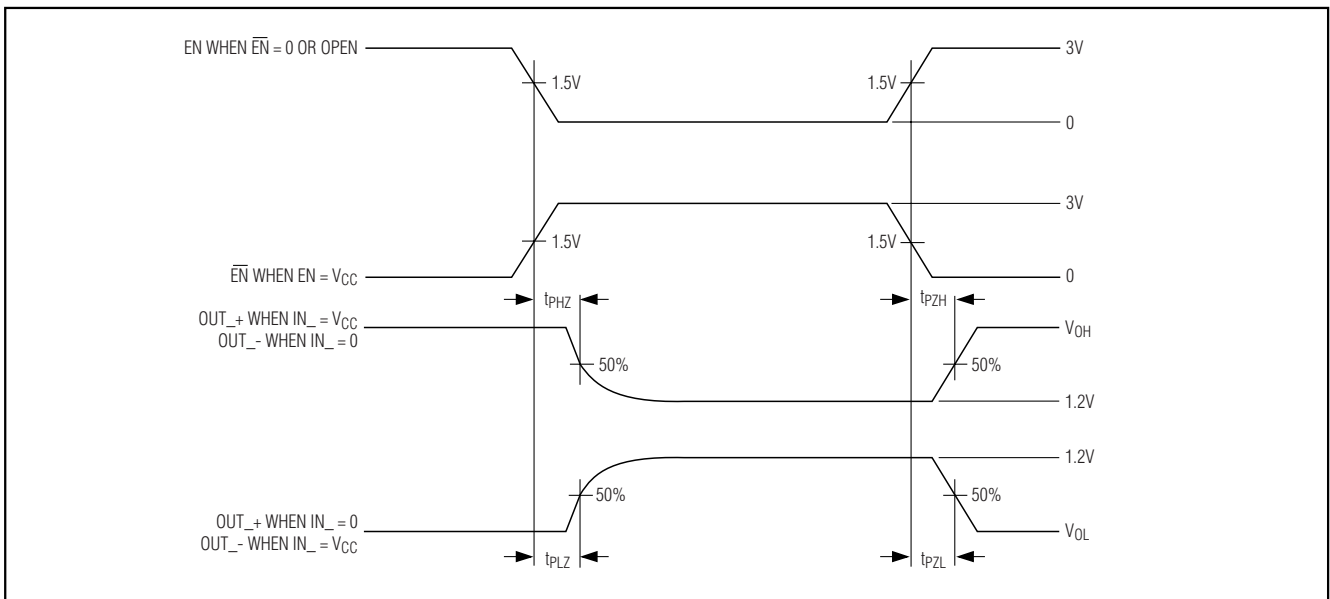
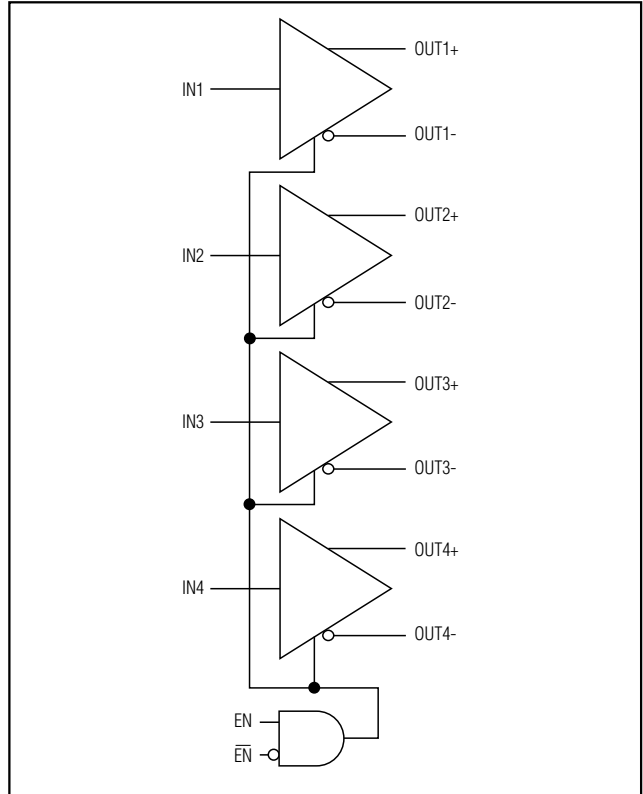

Figure 5. Driver High-Impedance Delay Waveform

Quad LVDS Line Driver with Flow-Through Pinout

Package Information

MAX9123

TOP VIEW

BOTTOM VIEW

SIDE VIEW

END VIEW

DETAIL A

LEAD TIP DETAIL

| Symbol | COMMON DIMENSIONS | | | |
|----------------|-------------------|-------|----------------|-------|
| | MILLIMETERS | | INCHES | |
| | MIN. | MAX. | MIN. | MAX. |
| A | — | 1.10 | — | .043 |
| A ₁ | 0.05 | 0.15 | .002 | .006 |
| A ₂ | 0.85 | 0.95 | .033 | .037 |
| b | 0.19 | 0.30 | .007 | .012 |
| b ₁ | 0.19 | 0.25 | .007 | .010 |
| c | 0.090 | 0.20 | .0035 | .008 |
| c ₁ | 0.090 | 0.135 | .0035 | .0053 |
| D | SEE VARIATIONS | | SEE VARIATIONS | |
| E | 4.30 | 4.50 | .169 | .177 |
| e | 0.65 BSC | | .026 BSC | |
| H | 6.25 | 6.50 | .246 | .256 |
| L | 0.50 | 0.70 | .020 | .028 |
| N | SEE VARIATIONS | | SEE VARIATIONS | |
| α | 0° | 8° | 0° | 8° |

| JEDEC | MD-153 | N | VARIATIONS | | | | |
|-------|--------|----|-------------|------|--------|------|------|
| | | | MILLIMETERS | | INCHES | | |
| | | | MIN. | MAX. | MIN. | MAX. | |
| | | 14 | D | 4.90 | 5.10 | .193 | .201 |
| | | 16 | D | 4.90 | 5.10 | .193 | .201 |
| | | 20 | D | 6.40 | 6.60 | .252 | .260 |
| | | 24 | D | 7.70 | 7.90 | .303 | .311 |
| | | 28 | D | 9.60 | 9.80 | .378 | .386 |

NOTES:

1. DIMENSIONS D AND E DO NOT INCLUDE FLASH
2. MOLD FLASH OR PROTRUSIONS NOT TO EXCEED 0.15mm PER SIDE
3. CONTROLLING DIMENSION: MILLIMETER
4. MEETS JEDEC OUTLINE MD-153 VARIATIONS- AB, AC, AD, AE, AF
5. *N* REFERS TO NUMBER OF LEADS

⚠ THE LEAD TIPS MUST LIE WITHIN A SPECIFIED ZONE. THIS TOLERANCE ZONE IS DEFINED BY TWO PARALLEL PLANES. ONE PLANE IS THE SEATING PLANE, DATUM [-C-]; THE OTHER PLANE IS AT THE SPECIFIED DISTANCE FROM [-C-] IN THE DIRECTION INDICATED.

MAXIM

PROPRIETARY INFORMATION

TITLE: PACKAGE OUTLINE, TSSOP, 4.40 MM BODY

| | | | |
|----------|---------------------------------|----------|-----|
| APPROVAL | DOCUMENT CONTROL NO. 21-0066 | REV D | 1/1 |
|----------|---------------------------------|----------|-----|

TSSOP, NO PADS, EPS

Quad LVDS Line Driver with Flow-Through Pinout

Package Information (continued)

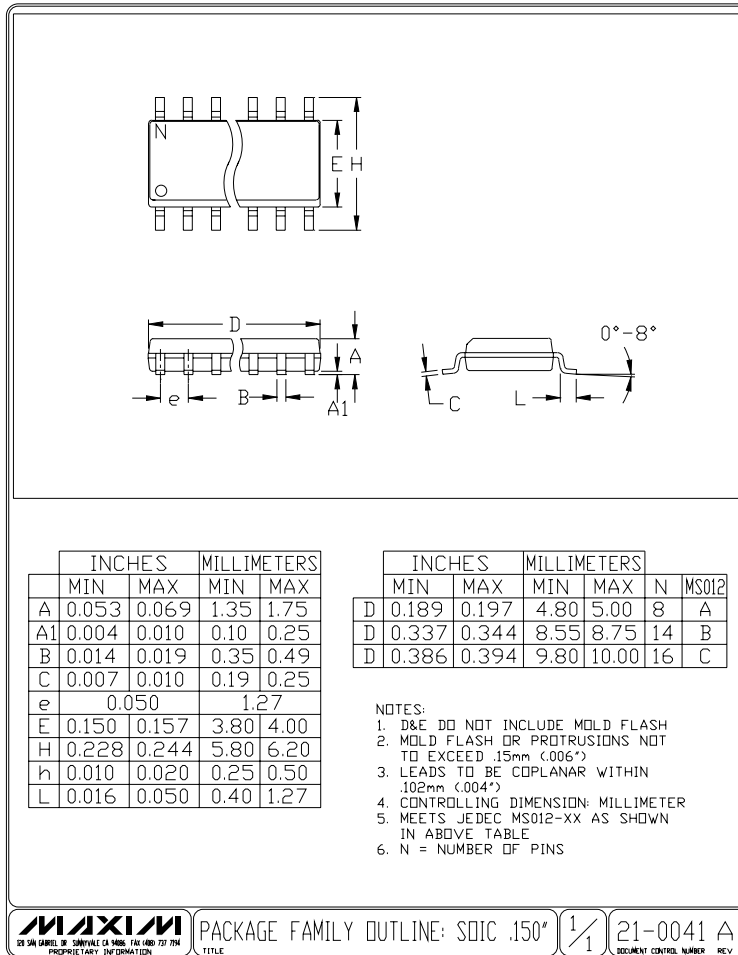

Maxim cannot assume responsibility for use of any circuitry other than circuitry entirely embodied in a Maxim product. No circuit patent licenses are implied. Maxim reserves the right to change the circuitry and specifications without notice at any time.

10 Maxim Integrated Products, 120 San Gabriel Drive, Sunnyvale, CA 94086 408-737-7600