

# MAXIM

## 5th-Order, Lowpass, Switched-Capacitor Filters

MAX7418-MAX7425

### General Description

The MAX7418–MAX7425 5th-order, low-pass, switched-capacitor filters (SCFs) operate from a single +5V (MAX7418–MAX7421) or +3V (MAX7422–MAX7425) supply. These devices draw only 3mA of supply current and allow corner frequencies from 1Hz to 45kHz, making them ideal for low-power post-DAC filtering and anti-aliasing applications. They feature a shutdown mode that reduces supply current to 0.2µA.

Two clocking options are available: self-clocking (through the use of an external capacitor), or external clocking for tighter corner-frequency control. An offset adjust pin allows for adjustment of the DC output level.

The MAX7418/MAX7422 deliver 53dB of stopband rejection and a sharp rolloff with a 1.6 transition ratio. The MAX7421/MAX7425 achieve a sharper rolloff with a 1.25 transition ratio while still providing 37dB of stopband rejection. The MAX7419/MAX7423 Bessel filters provide low overshoot and fast settling, and the MAX7420/MAX7424 Butterworth filters provide a maximally flat passband response. Their fixed response simplifies the design task of selecting a clock frequency.

### Applications

ADC Anti-Aliasing                      CT2 Base Stations  
DAC Postfiltering                      Speech Processing

### Selector Guide

PART	FILTER RESPONSE	OPERATING VOLTAGE (V)
MAX7418	r = 1.6	+5
MAX7419	Bessel	+5
MAX7420	Butterworth	+5
MAX7421	r = 1.25	+5

Selector Guide continued at end of data sheet.

### Pin Configuration

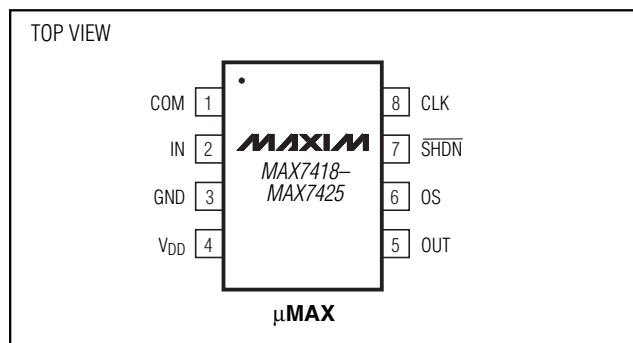

### Features

- ◆ 5th-Order, Lowpass Filters
  - Elliptic Response (MAX7418/MAX7421/MAX7422/MAX7425)
  - Bessel Response (MAX7419/MAX7423)
  - Butterworth Response (MAX7420/MAX7424)
- ◆ Clock-Turnable Corner Frequency (1Hz to 45kHz)
- ◆ Single-Supply Operation
  - +5V (MAX7418–MAX7421)
  - +3V (MAX7422–MAX7425)
- ◆ Low Power
  - 3mA (Operating Mode)
  - 0.2µA (Shutdown Mode)
- ◆ Available in 8-Pin μMAX Package
- ◆ Low Output Offset: ±4mV

### Ordering Information

PART	TEMP. RANGE	PIN-PACKAGE
MAX7418CUA	0°C to +70°C	8 μMAX
MAX7418EUA	-40°C to +85°C	8 μMAX
MAX7419CUA	0°C to +70°C	8 μMAX
MAX7419EUA	-40°C to +85°C	8 μMAX
MAX7420CUA	0°C to +70°C	8 μMAX
MAX7420EUA	-40°C to +85°C	8 μMAX
MAX7421CUA	0°C to +70°C	8 μMAX
MAX7421EUA	-40°C to +85°C	8 μMAX

Ordering Information continued at end of data sheet.

### Typical Operating Circuit

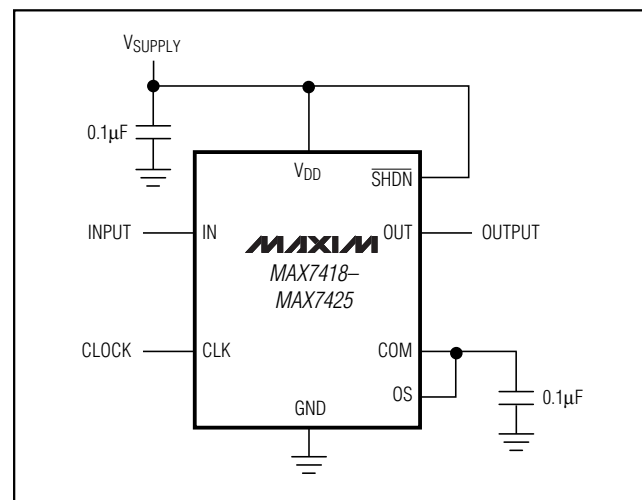

# 5th-Order, Lowpass, Switched-Capacitor Filters

## ABSOLUTE MAXIMUM RATINGS

V <sub>DD</sub> to GND	-0.3V to +6V
IN, OUT, COM, OS, CLK, SHDN	-0.3V to (V <sub>DD</sub> + 0.3V)
OUT Short-Circuit Duration	1s
Continuous Power Dissipation (T <sub>A</sub> = +70°C)	
8-Pin μMAX (derate 4.1mW/°C above +70°C)	330mW

### Operating Temperature Ranges

MAX74 __C_A	0°C to +70°C
MAX74 __E_A	-40°C to +85°C
Junction Temperature	+150°C
Storage Temperature Range	-65°C to +160°C
Lead Temperature (soldering, 10s)	+300°C

Stresses beyond those listed under "Absolute Maximum Ratings" may cause permanent damage to the device. These are stress ratings only, and functional operation of the device at these or any other conditions beyond those indicated in the operational sections of the specifications is not implied. Exposure to absolute maximum rating conditions for extended periods may affect device reliability.

## ELECTRICAL CHARACTERISTICS—MAX7418—MAX7421

(V<sub>DD</sub> = +5V, filter output measured at OUT, 10kΩ || 50pF load to GND at OUT, OS = COM, 0.1μF capacitor from COM to GND, SHDN = V<sub>DD</sub>, f<sub>CLK</sub> = 2.2MHz, T<sub>A</sub> = T<sub>MIN</sub> to T<sub>MAX</sub>, unless otherwise noted. Typical values are at T<sub>A</sub> = +25°C.)

PARAMETER	SYMBOL	CONDITIONS	MIN	TYP	MAX	UNITS	
<b>FILTER CHARACTERISTICS</b>							
Corner Frequency	f <sub>C</sub>	V <sub>IN</sub> = 4Vp-p (Note 1)	0.001 to 30			kHz	
Clock-to-Corner Ratio	f <sub>CLK</sub> / f <sub>C</sub>		100:1				
Clock-to-Corner Tempco			10			ppm/°C	
Output Voltage Range			0.25	V <sub>DD</sub> - 0.25		V	
Output Offset Voltage	V <sub>OFFSET</sub>	V <sub>IN</sub> = V <sub>COM</sub> = V <sub>DD</sub> / 2	±4	±25		mV	
DC Insertion Gain with Output Offset Removed		V <sub>COM</sub> = V <sub>DD</sub> / 2 (Note 2)	MAX7418/MAX7421	0	0.2	0.4	dB
			MAX7419/MAX7420	-0.2	0	+0.2	
Total Harmonic Distortion plus Noise	THD+N	f <sub>IN</sub> = 2kHz, V <sub>IN</sub> = 4Vp-p, measurement bandwidth = 80kHz	MAX7418	-76		dB	
			MAX7419	-78			
			MAX7420	-67			
			MAX7421	-78			
Offset Voltage Gain	A <sub>OS</sub>	OS to OUT	1			V/V	
COM Voltage Range	V <sub>COM</sub>	Input, COM externally driven	2.0	2.5	3.0	V	
		Output, COM unconnected	2.3	2.5	2.7		
Input Voltage Range at OS	V <sub>OS</sub>	Input, OS externally driven	V <sub>COM</sub> ±0.1			V	
Input Resistance at COM	R <sub>COM</sub>		100	140		kΩ	
Clock Feedthrough			5			mVp-p	
Resistive Output Load Drive	R <sub>L</sub>		10	1		kΩ	
Maximum Capacitive Output Load Drive	C <sub>L</sub>		50	500		pF	
Input Leakage Current at COM		SHDN = GND, V <sub>COM</sub> = 0 to V <sub>DD</sub>	±0.1	±10		μA	
Input Leakage Current at OS		V <sub>OS</sub> = 0 to V <sub>DD</sub>	±0.1	±10		μA	
<b>CLOCK</b>							
Internal Oscillator Frequency	f <sub>OSC</sub>	C <sub>OSC</sub> = 1000pF (Note 3)	MAX7418/MAX7421	68	87	106	kHz
			MAX7419/MAX7420	86	110	135	
Clock Output Current (Internal Oscillator Mode)	I <sub>CLK</sub>	V <sub>CLK</sub> = 0 or 5V	MAX7418/MAX7421	±40	±60		μA
			MAX7419/MAX7420	±50	±75		
Clock Input High	V <sub>IH</sub>		4.5			V	
Clock Input Low	V <sub>IL</sub>					0.5 V	

# 5th-Order, Lowpass, Switched-Capacitor Filters

MAX7418-MAX7425

## ELECTRICAL CHARACTERISTICS—MAX7418—MAX7421 (continued)

( $V_{DD} = +5V$ , filter output measured at OUT,  $10k\Omega$  ||  $50pF$  load to GND at OUT, OS = COM,  $0.1\mu F$  capacitor from COM to GND,  $\overline{SHDN} = V_{DD}$ ,  $f_{CLK} = 2.2MHz$ ,  $T_A = T_{MIN}$  to  $T_{MAX}$ , unless otherwise noted. Typical values are at  $T_A = +25^\circ C$ .)

PARAMETER	SYMBOL	CONDITIONS	MIN	TYP	MAX	UNITS
<b>POWER REQUIREMENTS</b>						
Supply Voltage	$V_{DD}$		4.5		5.5	V
Supply Current	$I_{DD}$	Operating mode, no load	MAX7418/MAX7421	2.9	3.6	mA
			MAX7419/MAX7420	3.4	4.1	
Shutdown Current	$I_{\overline{SHDN}}$	$\overline{SHDN} = GND$		0.2	1	$\mu A$
Power-Supply Rejection Ratio	PSRR	IN = COM (Note 4)		70		dB
<b>SHUTDOWN</b>						
$\overline{SHDN}$ Input High	$V_{SDH}$		4.5			V
$\overline{SHDN}$ Input Low	$V_{SDL}$				0.5	V
$\overline{SHDN}$ Input Leakage Current		$V_{\overline{SHDN}} = 0$ to $V_{DD}$		$\pm 0.2$	$\pm 10$	$\mu A$

## ELECTRICAL CHARACTERISTICS—MAX7422—MAX7425

( $V_{DD} = +3V$ , filter output measured at OUT pin,  $10k\Omega$  ||  $50pF$  load to GND at OUT, OS = COM,  $0.1\mu F$  capacitor from COM to GND,  $\overline{SHDN} = V_{DD}$ ,  $f_{CLK} = 2.2MHz$ ,  $T_A = T_{MIN}$  to  $T_{MAX}$ , unless otherwise noted. Typical values are at  $T_A = +25^\circ C$ .)

PARAMETER	SYMBOL	CONDITIONS	MIN	TYP	MAX	UNITS	
<b>FILTER CHARACTERISTICS</b>							
Corner-Frequency Range	$f_c$	$V_{IN} = 2.5Vp-p$ (Note 1)	MAX7422/MAX7425	0.001 to 45		kHz	
			MAX7423/MAX7424				
Clock-to-Corner Ratio	$f_{CLK}/f_c$			100:1			
Clock-to-Corner Tempco				10		ppm/ $^\circ C$	
Output Voltage Range			0.25	$V_{DD} - 0.25$		V	
Output Offset Voltage	$V_{OFFSET}$	$V_{IN} = V_{COM} = V_{DD} / 2$		$\pm 4$	$\pm 25$	mV	
DC Insertion Gain with Output Offset Removed		$V_{COM} = V_{DD} / 2$ (Note 2)	MAX7422/MAX7425	0	0.2	0.4	dB
			MAX7423/MAX7424	-0.2	0	+0.2	
Total Harmonic Distortion plus Noise	THD+N	$f_{IN} = 2kHz$ , $V_{IN} = 2.5Vp-p$ , measurement bandwidth = 80kHz	MAX7422	-80		dB	
			MAX7423	-81			
			MAX7424	-70			
			MAX7425	-80			
Offset Voltage Gain	AOS	OS to OUT		1		V/V	
COM Voltage Range	$V_{COM}$	Input, COM externally driven	1.4	1.5	1.6	V	
		Output, COM internally driven	1.4	1.5	1.6		
Input Voltage Range at OS	$V_{OS}$	Measured with respect to COM		$V_{COM} \pm 0.1$		V	
Input Resistance at COM	$R_{COM}$		100	140		$k\Omega$	
Clock Feedthrough				3		mVp-p	
Resistive Output Load Drive	$R_L$		10	1		$k\Omega$	
Maximum Capacitive Load at OUT	$C_L$		50	500		pF	
Input Leakage Current at COM		$\overline{SHDN} = GND$ , $V_{COM} = 0$ to $V_{DD}$		$\pm 0.1$	$\pm 10$	$\mu A$	
Input Leakage Current at OS		$V_{OS} = 0$ to $V_{DD}$		$\pm 0.1$	$\pm 10$	$\mu A$	

# 5th-Order, Lowpass, Switched-Capacitor Filters

## ELECTRICAL CHARACTERISTICS—MAX7422–MAX7425 (continued)

( $V_{DD} = +3V$ , filter output measured at OUT pin,  $10k\Omega$  ||  $50pF$  load to GND at OUT, OS = COM,  $0.1\mu F$  capacitor from COM to GND,  $\overline{SHDN} = V_{DD}$ ,  $f_{CLK} = 2.2MHz$ ,  $T_A = T_{MIN}$  to  $T_{MAX}$ , unless otherwise noted. Typical values are at  $T_A = +25^\circ C$ .)

PARAMETER	SYMBOL	CONDITIONS	MIN	TYP	MAX	UNITS	
<b>CLOCK</b>							
Internal Oscillator Frequency	$f_{OSC}$	$C_{OSC} = 1000pF$ (Note 3)	MAX7422/MAX7425	68	87	106	kHz
			MAX7423/MAX7424	86	110	135	
Clock Output Current (Internal Oscillator Mode)	$I_{CLK}$		MAX7422/MAX7425	68	87	106	kHz
			MAX7423/MAX7424	86	110	135	
Clock Input High	$V_{IH}$		2.5			V	
Clock Input Low	$V_{IL}$					0.5	V
<b>POWER REQUIREMENTS</b>							
Supply Voltage	$V_{DD}$		2.7		3.6		V
Supply Current	$I_{DD}$	Operating mode, no load	MAX7422/MAX7425	2.6		3.4	mA
			MAX7423/MAX7424	3.0		3.8	
Shutdown Current	$I_{\overline{SHDN}}$	$\overline{SHDN} = GND$	0.2		1		$\mu A$
Power-Supply Rejection Ratio	PSRR	Measured at DC	70				dB
<b>SHUTDOWN</b>							
$\overline{SHDN}$ Input High	$V_{SDH}$		2.5			V	
$\overline{SHDN}$ Input Low	$V_{SDL}$					0.5	V
$\overline{SHDN}$ Input Leakage Current		$V_{\overline{SHDN}} = 0$ to $V_{DD}$	$\pm 0.2$		$\pm 10$		$\mu A$

## FILTER CHARACTERISTICS

( $V_{DD} = +5V$  for MAX7418–MAX7421,  $V_{DD} = +3V$  for MAX7422–MAX7425 filter output measured at OUT,  $10k\Omega$  ||  $50pF$  load to GND at OUT,  $\overline{SHDN} = V_{DD}$ ,  $f_{CLK} = 2.2MHz$ ,  $T_A = T_{MIN}$  to  $T_{MAX}$ , unless otherwise noted.)

PARAMETER	CONDITIONS	MIN	TYP	MAX	UNITS
<b>ELLIPTIC, <math>r = 1.2</math>—MAX7421/MAX7425</b>					
Insertion Gain with DC Gain Error Removed (Note 4)	$f_{IN} = 0.38f_C$	-0.4	$\pm 0.2$	0.4	dB
	$f_{IN} = 0.68f_C$	-0.4	$\pm 0.2$	0.4	
	$f_{IN} = 0.87f_C$	-0.4	$\pm 0.2$	0.4	
	$f_{IN} = 0.97f_C$	-0.4	$\pm 0.2$	0.4	
	$f_{IN} = f_C$	-0.7	$\pm 0.2$	0.2	
	$f_{IN} = 1.25f_C$		-36	-33	
	$f_{IN} = 1.43f_C$		-37.2	-35	
	$f_{IN} = 3.25f_C$		-37.2	-35	
<b>BESSEL FILTERS—MAX7419/MAX7423</b>					
Insertion Gain Relative to DC Gain	$f_{IN} = 0.5f_C$	-1	-0.74		dB
	$f_{IN} = f_C$	-3.6	-3.0	-2.4	
	$f_{IN} = 4f_C$		-41.0	-35	
	$f_{IN} = 7f_C$		-67	-60	

# 5th-Order, Lowpass, Switched-Capacitor Filters

MAX7418-MAX7425

## FILTER CHARACTERISTICS

( $V_{DD} = +5V$  for MAX7418-MAX7421,  $V_{DD} = +3V$  for MAX7422-MAX7425 filter output measured at OUT, 10k $\Omega$  || 50pF load to GND at OUT,  $\overline{SHDN} = V_{DD}$ ,  $f_{CLK} = 2.2MHz$ ,  $T_A = T_{MIN}$  to  $T_{MAX}$ , unless otherwise noted.)

PARAMETER	CONDITIONS	MIN	TYP	MAX	UNITS
<b>BUTTERWORTH FILTERS—MAX7420/MAX7424</b>					
Insertion Gain Relative to DC Gain	$f_{IN} = 0.5f_C$	-0.3	0		dB
	$f_{IN} = f_C$	-3.6	-3.0	-2.4	
	$f_{IN} = 3f_C$		-47.5	-43	
	$f_{IN} = 5f_C$		-70	-65	

**Note 1:** The maximum  $f_C$  is defined as the clock frequency  $f_{CLK} = 100 \times f_C$  at which the peak S / (THD+N) drops to 68dB with a sinusoidal input at  $0.2f_C$ . Maximum  $f_C$  increases as  $V_{IN}$  signal amplitude decreases.

**Note 2:** DC insertion gain is defined as  $\Delta V_{OUT} / \Delta V_{IN}$ .

**Note 3:** MAX7418/MAX7421/MAX7422/MAX7425:  $f_{OSC} (kHz) \cong 87 \times 10^3 / C_{OSC} (pF)$ .  
MAX7419/MAX7420/MAX7423/MAX7424:  $f_{OSC} (kHz) \cong 110 \times 10^3 / C_{OSC} (pF)$ .

**Note 4:** PSRR is the change in output voltage from a  $V_{DD}$  of 4.5V and a  $V_{DD}$  of 5.5V.

## Typical Operating Characteristics

( $V_{DD} = +5V$  for MAX7418-MAX7421,  $V_{DD} = +3V$  for MAX7422-MAX7425,  $f_{CLK} = 2.2MHz$ ,  $\overline{SHDN} = V_{DD}$ ,  $V_{COM} = V_{OS} = V_{DD} / 2$ ,  $T_A = +25^\circ C$ , unless otherwise noted.)

**MAX7418/MAX7422**  
FREQUENCY RESPONSE (ELLIPTIC,  $r = 1.6$ )

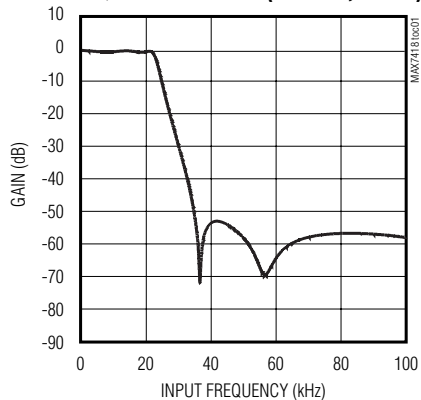

**MAX7419/MAX7423**  
FREQUENCY RESPONSE (BESSEL)

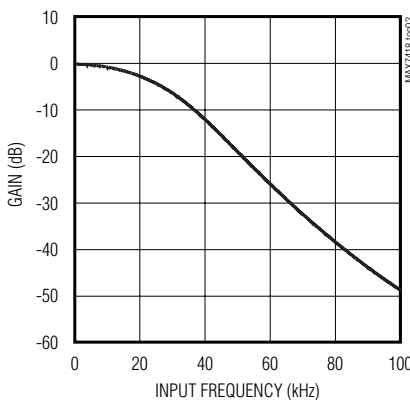

**MAX7420/MAX7424**  
FREQUENCY RESPONSE (BUTTERWORTH)

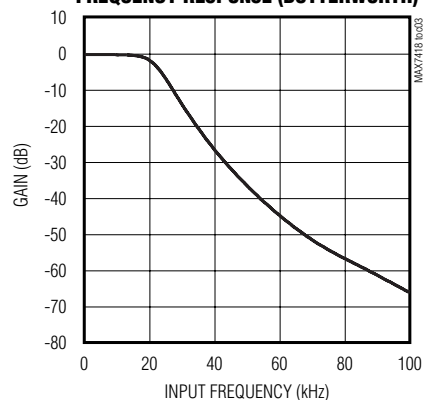

# 5th-Order, Lowpass, Switched-Capacitor Filters

## Typical Operating Characteristics (continued)

( $V_{DD} = +5V$  for MAX7418-MAX7421,  $V_{DD} = +3V$  for MAX7422-MAX7425,  $f_{CLK} = 2.2MHz$ ,  $\overline{SHDN} = V_{DD}$ ,  $V_{COM} = V_{OS} = V_{DD} / 2$ ,  $T_A = +25^\circ C$ , unless otherwise noted.)

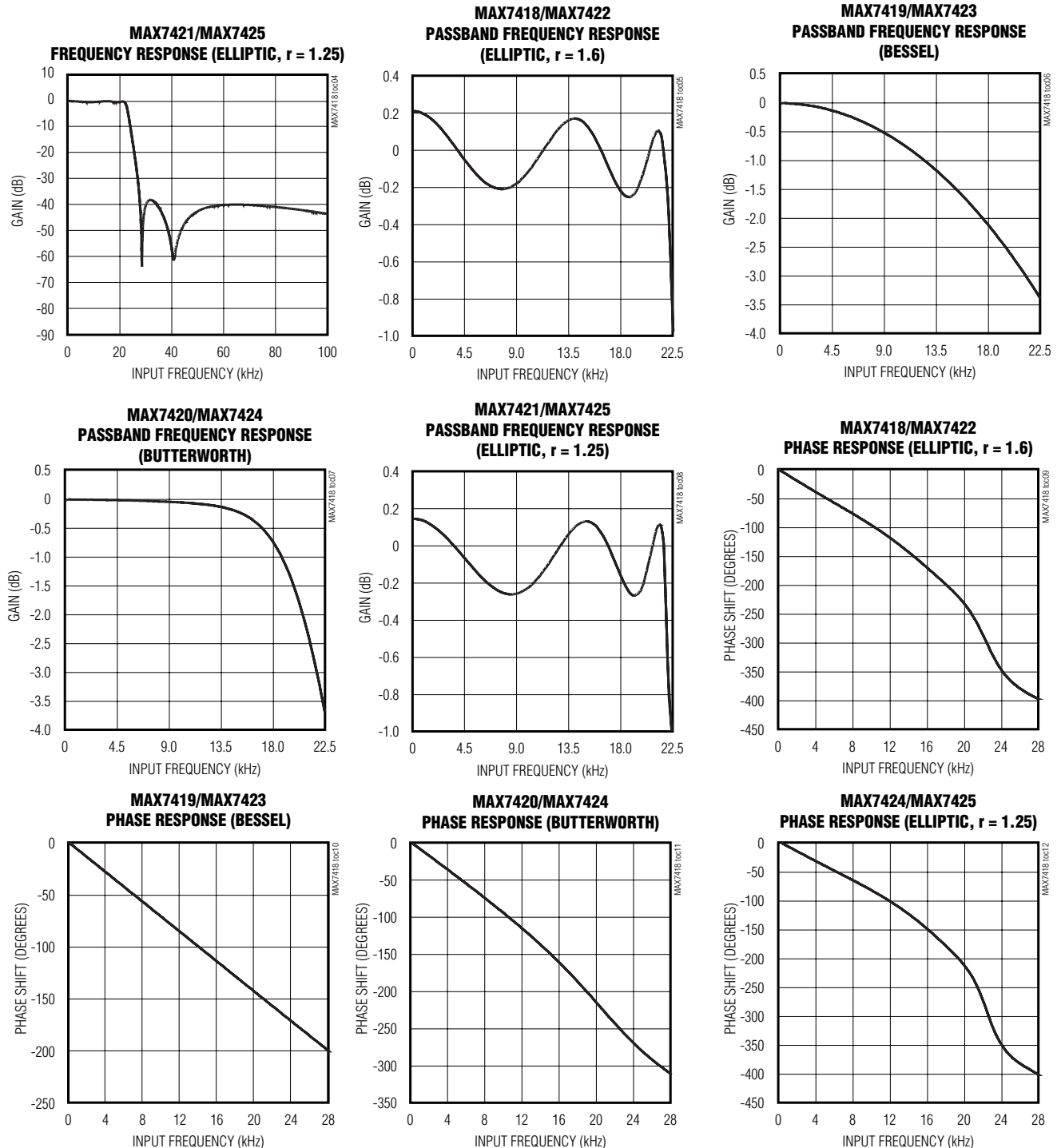

# 5th-Order, Lowpass, Switched-Capacitor Filters

MAX7418-MAX7425

## Typical Operating Characteristics (continued)

( $V_{DD} = +5V$  for MAX7418-MAX7421,  $V_{DD} = +3V$  for MAX7422-MAX7425,  $f_{CLK} = 2.2MHz$ ,  $\overline{SHDN} = V_{DD}$ ,  $V_{COM} = V_{OS} = V_{DD} / 2$ ,  $T_A = +25^\circ C$ , unless otherwise noted.)

**MAX7418**

**THD + NOISE vs. INPUT SIGNAL AMPLITUDE (ELLIPTIC,  $r = 1.6$ )**

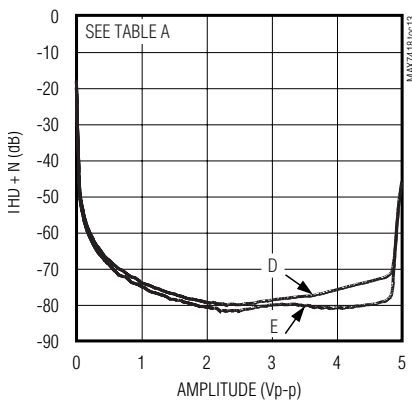

**MAX7419**

**THD + NOISE vs. INPUT SIGNAL AMPLITUDE (BESSEL)**

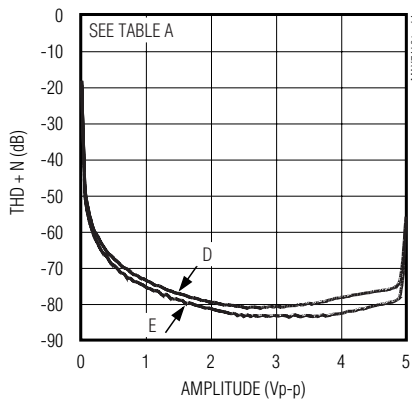

**MAX7420**

**THD + NOISE vs. INPUT SIGNAL AMPLITUDE (BUTTERWORTH)**

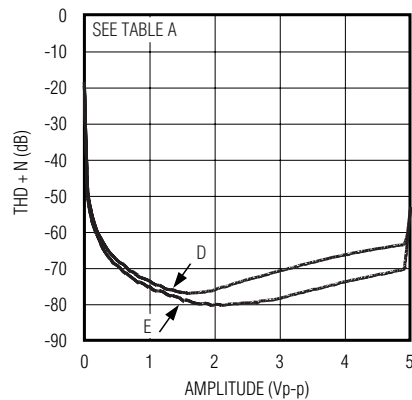

**MAX7421**

**THD + NOISE vs. INPUT SIGNAL AMPLITUDE (ELLIPTIC,  $r = 1.25$ )**

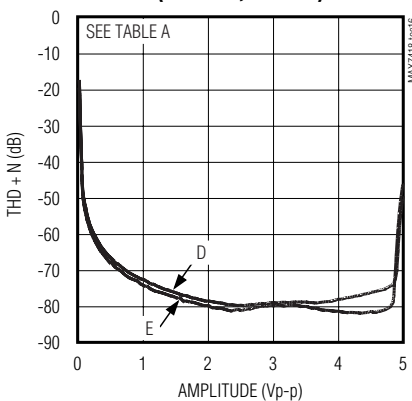

**MAX7422**

**THD + NOISE vs. INPUT SIGNAL AMPLITUDE (ELLIPTIC,  $r = 1.6$ )**

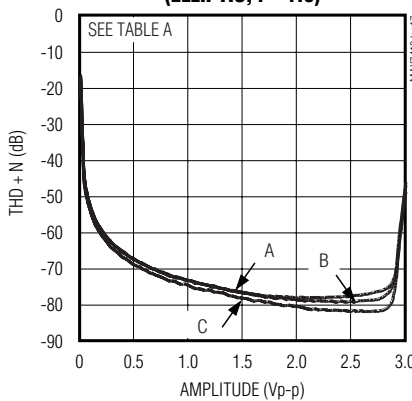

**MAX7423**

**THD + NOISE vs. INPUT SIGNAL AMPLITUDE (BESSEL)**

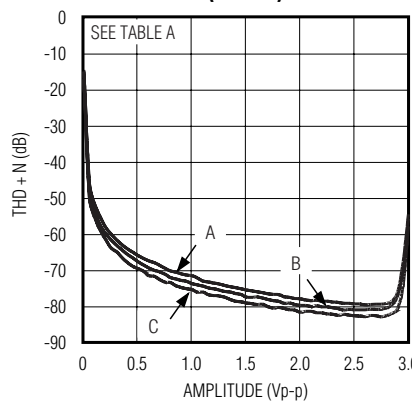

**MAX7424**

**THD + NOISE vs. INPUT SIGNAL AMPLITUDE (BUTTERWORTH)**

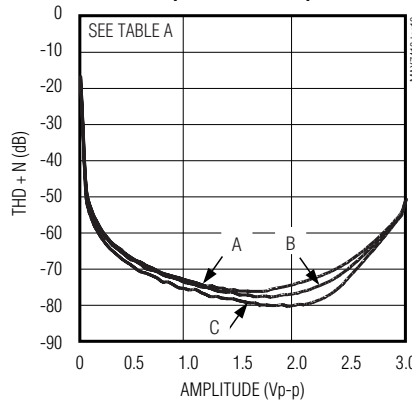

**MAX7425**

**THD + NOISE vs. INPUT SIGNAL AMPLITUDE (ELLIPTIC,  $r = 1.25$ )**

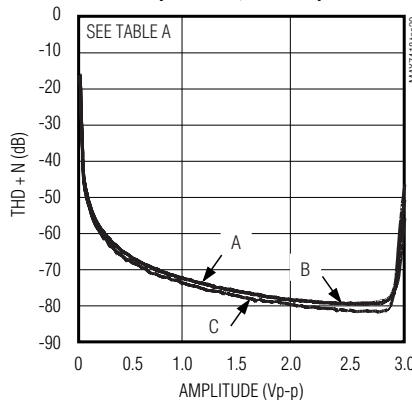

**INTERNAL OSCILLATOR FREQUENCY vs. SMALL CAPACITANCE (pF)**

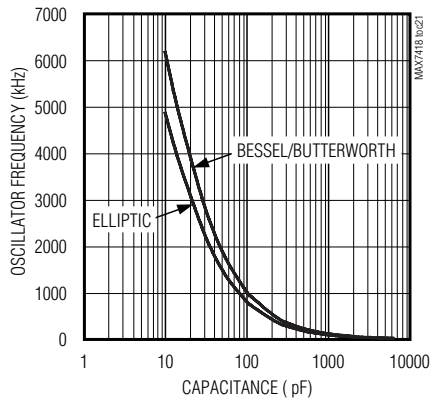

# 5th-Order, Lowpass, Switched-Capacitor Filters

## Typical Operating Characteristics (continued)

( $V_{DD} = +5V$  for MAX7418–MAX7421,  $V_{DD} = +3V$  for MAX7422–MAX7425,  $f_{CLK} = 2.2MHz$ ,  $\overline{SHDN} = V_{DD}$ ,  $V_{COM} = V_{OS} = V_{DD} / 2$ ,  $T_A = +25^\circ C$ , unless otherwise noted.)

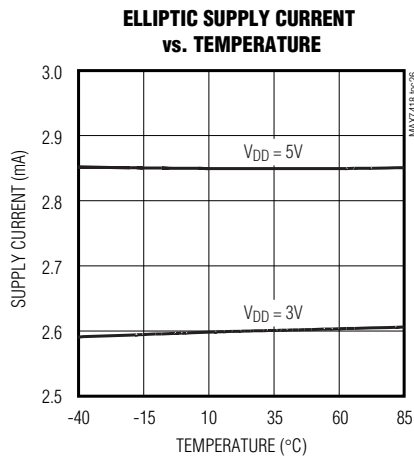
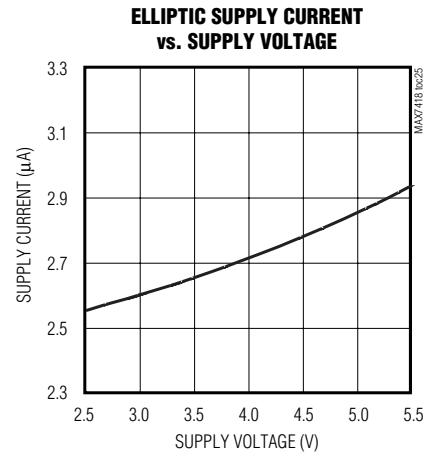
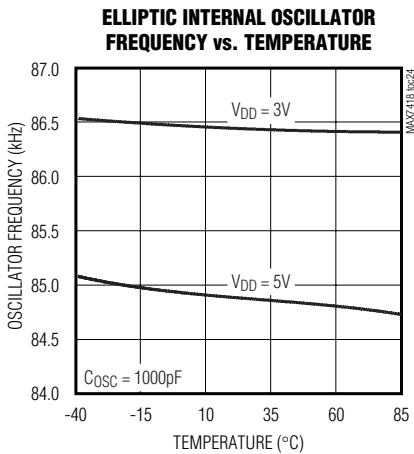
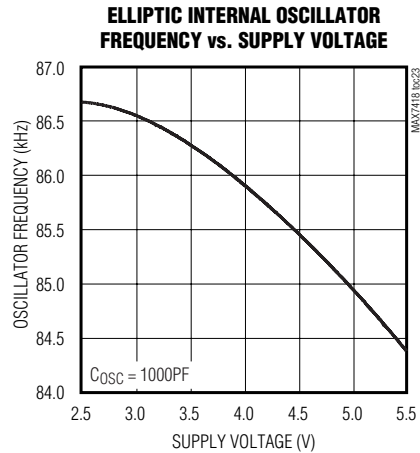
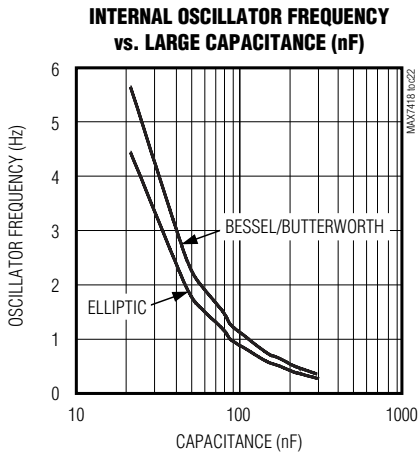

**Table A.**

LABEL	$f_{IN}$ (kHz)	$f_C$ (kHz)	$f_{CLK}$ (kHz)	BW (kHz)
A	2	30	3000	80
B	2	22	2200	80
C	1	10	1000	22
D	2	22	2200	80
E	1	10	1000	22



# 5th-Order, Lowpass, Switched-Capacitor Filters

MAX7418-MAX7425

## Typical Operating Characteristics (continued)

( $V_{DD} = +5V$  for MAX7418–MAX7421,  $V_{DD} = +3V$  for MAX7422–MAX7425,  $f_{CLK} = 2.2MHz$ ,  $\overline{SHDN} = V_{DD}$ ,  $V_{COM} = V_{OS} = V_{DD} / 2$ ,  $T_A = +25^\circ C$ , unless otherwise noted.)

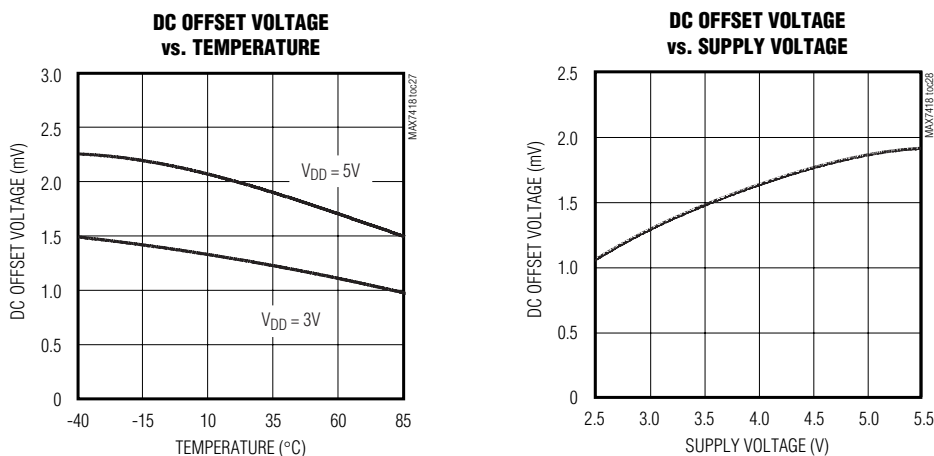

## Pin Description

PIN	NAME	FUNCTION
1	COM	Common Input Pin. Biased internally at midsupply. Bypass COM externally to GND with a 0.1 $\mu F$ capacitor. To override internal biasing, drive COM with an external supply.
2	IN	Filter Input
3	GND	Ground
4	$V_{DD}$	Positive Supply Input: +5V for MAX7418–MAX7421, +3V for MAX7422–MAX7425. Bypass $V_{DD}$ to GND with a 0.1 $\mu F$ capacitor.
5	OUT	Filter Output
6	OS	Offset Adjust Input. To adjust output offset, connect OS to an external supply through a resistive voltage-divider (Figure 4). Connect OS to COM if no offset adjustment is needed. See the <i>Offset and Common-Mode Input Adjustment</i> section.
7	$\overline{SHDN}$	Shutdown Input. Drive low to enable shutdown mode; drive high or connect to $V_{DD}$ for normal operation.
8	CLK	Clock Input. Connect an external capacitor ( $C_{OSC}$ ) from CLK to ground. To override the internal oscillator, connect CLK to an external clock: $f_C = f_{CLK} / 100$ .

## Detailed Description

The MAX7418/MAX7421/MAX7422/MAX7425 elliptic lowpass filters provide sharp rolloff with good stopband rejection. The MAX7419/MAX7423 Bessel filters provide low overshoot and fast settling responses, and the MAX7420/MAX7424 Butterworth filters provide a maximally flat passband response. All parts operate with a 100:1 clock-to-corner frequency ratio.

Most switch capacitor filters (SCFs) are designed with biquadratic sections. Each section implements two pole-zero pairs, and the sections can be cascaded to

produce higher order filters. The advantage to this approach is ease of design. However, this type of design is highly sensitive to component variations if any section's Q is high. The MAX7418–MAX7425 use an alternative approach, which is to emulate a passive network using switched-capacitor integrators with summing and scaling. The passive network may be synthesized using CAD programs, or may be found in many filter books. Figure 1 shows a basic 5th-order ladder filter structure.

## 5th-Order, Lowpass, Switched-Capacitor Filters

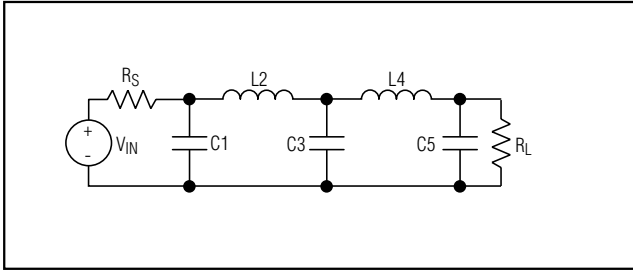

Figure 1. 5th-Order Ladder Filter Network

An SCF that emulates a passive ladder filter retains many of the same advantages. The component sensitivity of a passive ladder filter is low when compared to a cascaded biquadratic design because each component affects the entire filter shape rather than a single pole-zero pair. In other words, a mismatched component in a biquadratic design has a concentrated error on its respective poles, while the same mismatch in a ladder filter design spreads its error over all poles.

### Elliptic Characteristics

Lowpass elliptic filters such as the MAX7418/MAX7421/MAX7422/MAX7425 provide the steepest possible rolloff with frequency of the four most common filter types (Butterworth, Bessel, Chebyshev, and elliptic). The high-Q value of the poles near the passband edge combined with the stopband zeros allow for the sharp attenuation characteristic of elliptic filters, making these devices ideal for anti-aliasing and post-DAC filtering in single-supply systems (see *Anti-Aliasing and Post-DAC Filtering*).

In the frequency domain, the first transmission zero causes the filter's amplitude to drop to a minimum level (Figure 2). Beyond this zero, the response rises as the frequency increases until the next transmission zero. The stopband begins at the stopband frequency,  $f_s$ . At frequencies above  $f_s$ , the filter's gain does not exceed the gain at  $f_s$ . The corner frequency,  $f_c$ , is defined as the point at which the filter output attenuation falls just below the passband ripple. The transition ratio ( $r$ ) is defined as the ratio of the stopband frequency to the corner frequency:

$$r = f_s / f_c$$

The MAX7418/MAX7422 have a transition ratio of 1.6 and typically 53dB of stopband rejection. The MAX7421/MAX7425 have a transition ratio of 1.25 (providing a steeper rolloff) and typically 37dB of stopband rejection.

### Bessel Characteristics

Lowpass Bessel filters such as the MAX7419/MAX7423

delay all frequency components equally, preserving the line up shape of step inputs (subject to the attenuation of the higher frequencies). Bessel filters settle quickly—an important characteristic in applications that use a multiplexer (mux) to select an input signal for an analog-to-digital converter (ADC). An anti-aliasing filter placed between the mux and the ADC must settle quickly after a new channel is selected.

### Butterworth Characteristics

Lowpass Butterworth filters such as the MAX7420/MAX7424 provide a maximally flat passband response, making them ideal for instrumentation applications that require minimum deviation from the DC gain throughout the passband.

The difference between Bessel and Butterworth filters can be observed when a 1kHz square wave is applied to the filter input (Figure 3, trace A). With the filter cutoff frequencies set at 5kHz, trace B shows the Bessel filter response and trace C shows the Butterworth filter response.

### Clock Signal

#### External Clock

These SCFs are designed for use with external clocks that have a 40% to 60% duty cycle. When using an external clock, drive the CLK pin with a CMOS gate powered from 0 to  $V_{DD}$ . Varying the rate of the external clock adjusts the corner frequency of the filter:

$$f_c = \frac{f_{CLK}}{100}$$

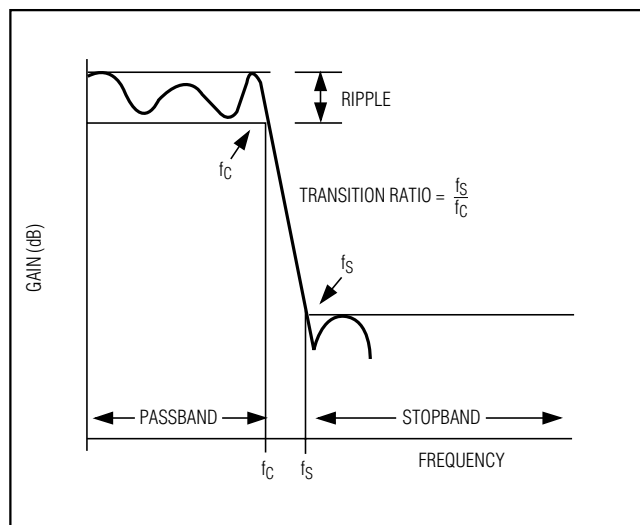

Figure 2. Elliptic Filter Response

# 5th-Order, Lowpass, Switched-Capacitor Filters

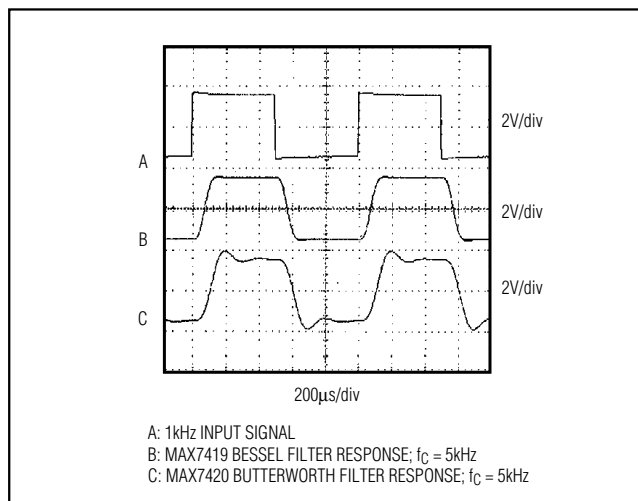

Figure 3. Bessel vs. Butterworth Filter Response

### Internal Clock

When using the internal oscillator, the capacitance ( $C_{OSC}$ ) on CLK determines the oscillator frequency:

$$f_{OSC}(\text{kHz}) = \frac{k}{C_{OSC}(\text{pF})}$$

where

$k = 87 \times 10^3$  for the  
 MAX7418/MAX7421/MAX7422/MAX7425

and

$k = 110 \times 10^3$  for the  
 MAX7419/MAX7420/MAX7423/ MAX7424.

Since  $C_{OSC}$  is in the low picofarads, minimize the stray capacitance at CLK so that it does not affect the internal oscillator frequency. Varying the rate of the internal oscillator adjusts the filter's corner frequency by a 100:1 clock-to-corner frequency ratio. For example, an internal oscillator frequency of 2.2MHz produces a nominal corner frequency of 2.2kHz.

### Input Impedance vs. Clock Frequencies

The MAX7418-MAX7425s' input impedance is effective as a switched-capacitor resistor and is inversely proportional to frequency. The input impedance values determined by the equation represents the average input impedance, since the input current is not continuous. As a rule, use a driver with an output resistance less than 10% of the filter's input impedance.

Estimate the input impedance of the filter by using the following formula:

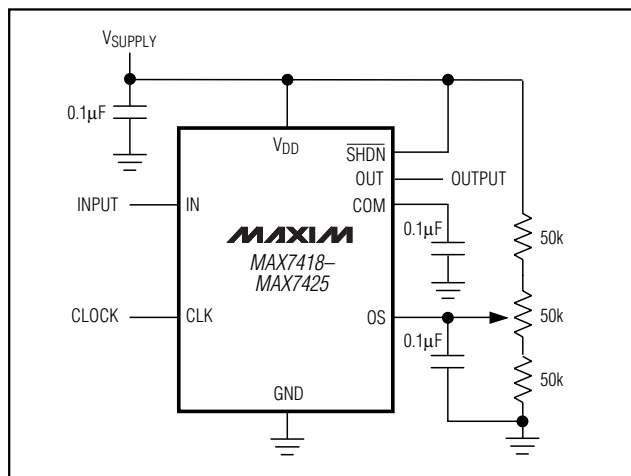

Figure 4. Offset Adjustment Circuit

$$Z_{IN} = \frac{1}{(f_{CLK} \times C_{IN})}$$

where  $f_{CLK}$  = clock frequency and  $C_{IN} = 1\text{pF}$ .

### Low-Power Shutdown Mode

The MAX7418-MAX7425 have a shutdown mode that is activated by driving  $\overline{\text{SHDN}}$  low. In shutdown mode, the filter supply current reduces to  $0.2\mu\text{A}$ , and the output of the filter becomes high impedance. For normal operation, drive  $\overline{\text{SHDN}}$  high or connect to  $V_{DD}$ .

## Applications Information

### Offset (OS) and Common-Mode (COM) Input Adjustment

COM sets the common-mode input voltage and is biased at midsupply with an internal resistor-divider. If the application does not require offset adjustment, connect OS to COM. For applications in which offset adjustment is required, apply an external bias voltage through a resistor-divider network to OS, as shown in Figure 4. For applications that require DC level shifting, adjust OS with respect to COM. (**Note:** Do not leave OS unconnected.) The output voltage is represented by these equations:

$$V_{OUT} = (V_{IN} - V_{COM}) + V_{OS}$$

$$V_{COM} = \frac{V_{DD}}{2} \text{ (typ)}$$

where  $(V_{IN} - V_{COM})$  is lowpass filtered by the SCF and OS is added at the output stage. See the *Electrical Characteristics* table for the input voltage range of COM

# 5th-Order, Lowpass, Switched-Capacitor Filters

and OS. Changing the voltage on COM or OS significantly from midsupply reduces the dynamic range.

### Power Supplies

The MAX7418-MAX7421 operate from a single +5V supply and the MAX7422-MAX7425 operate from a single +3V supply. Bypass  $V_{DD}$  to GND with a  $0.1\mu\text{F}$  capacitor. If dual supplies are required, connect COM to the system ground and GND to the negative supply. Figure 5 shows an example of dual-supply operation. Single-supply and dual-supply performance are equivalent. For either single-supply or dual-supply operation, drive CLK and  $\overline{\text{SHDN}}$  from GND ( $V^-$  in dual supply operation) to  $V_{DD}$ . Use the MAX7418-MAX7421 for  $\pm 2.5$ , and use the MAX7422-MAX7425 for  $\pm 1.5$ V. For  $\pm 5$ V dual-supply applications, refer to the MAX291/MAX292/MAX295/MAX296 and MAX293/MAX294/MAX297 data sheets.

### Input Signal Amplitude Range

The optimal input signal range is determined by observing the voltage level at which the signal-to-noise plus distortion (SINAD) ratio is maximized for a given corner frequency. The *Typical Operating Characteristics* show the THD + Noise response as the input signal's peak-to-peak amplitude is varied.

### Anti-Aliasing and Post-DAC Filtering

When using the MAX7418-MAX7425 for anti-aliasing or post-DAC filtering, synchronize the DAC (or ADC) and the filter clocks. If the clocks are not synchronized, beat frequencies may alias into the desired passband.

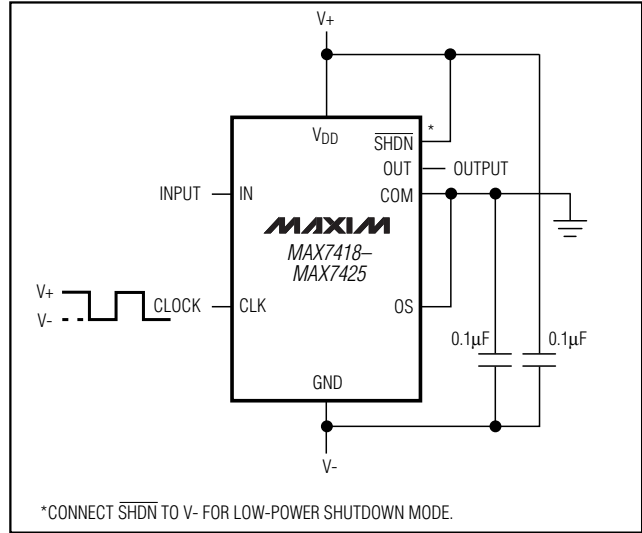

Figure 5. Dual-Supply Operation

### Harmonic Distortion

Harmonic distortion arises from nonlinearities within the filter. These nonlinearities generate harmonics when a pure sine wave is applied to the filter input. Tables 1, 2, and 3 list typical harmonic distortion values with a  $10\text{k}\Omega$  load at  $T_A = +25^\circ\text{C}$ .

Table 1. MAX7418/MAX7421/MAX7422/MAX7425 Typical Harmonic Distortion

FILTER	$f_{\text{CLK}}$ (MHz)	$f_{\text{IN}}$ (kHz)	$V_{\text{IN}}$ (Vp-p)	TYPICAL HARMONIC DISTORTION (dB)			
				2nd	3rd	4th	5th
MAX7418	2.2	2	4	<-80	<-80	<-80	<-80
	1.5	2		<-80	<-80	<-80	<-80
MAX7421	2.2	2	4	<-80	<-80	<-80	<-80
	1.5	2		<-80	<-80	<-80	<-80
MAX7422	4.0	4	2	<-80	<-80	<-80	<-80
	2.2	2		<-80	<-80	<-80	<-80
MAX7425	4.0	4	2	<-80	<-80	<-80	<-80
	2.2	2		<-80	<-80	<-80	<-80

# 5th-Order, Lowpass, Switched-Capacitor Filters

MAX7418-MAX7425

**Table 2. MAX7420/MAX7424 Typical Harmonic Distortion**

FILTER	f <sub>CLK</sub> (MHz)	f <sub>IN</sub> (kHz)	V <sub>IN</sub> (V <sub>p-p</sub> )	TYPICAL HARMONIC DISTORTION (dB)			
				2nd	3rd	4th	5th
MAX7420	2.2	2	4	-77	-67	< -80	-76
	1.5	2		< -80	-70	< -80	< -80
MAX7424	3.5	3	2	< -80	-70	< -80	< -80
	2.2	2		< -80	-77	< -80	< -80

**Table 3. MAX7419/MAX7423 Typical Harmonic Distortion**

FILTER	f <sub>CLK</sub> (MHz)	f <sub>IN</sub> (kHz)	V <sub>IN</sub> (V <sub>p-p</sub> )	TYPICAL HARMONIC DISTORTION (dB)			
				2nd	3rd	4th	5th
MAX7419	2.2	2	4	< -80	-77	< -80	< -80
	1.5	2		< -80	-80	< -80	< -80
MAX7423	3.5	3	2	< -80	-75	< -80	< -80
	2.2	2		< -80	< -80	< -80	< -80

## Ordering Information (continued)

PART	TEMP. RANGE	PIN-PACKAGE
MAX7422CUA	0°C to +70°C	8 μMAX
MAX7422EUA	-40°C to +85°C	8 μMAX
MAX7423CUA	0°C to +70°C	8 μMAX
MAX7423EUA	-40°C to +85°C	8 μMAX
MAX7424CUA	0°C to +70°C	8 μMAX
MAX7424EUA	-40°C to +85°C	8 μMAX
MAX7425CUA	0°C to +70°C	8 μMAX
MAX7425EUA	-40°C to +85°C	8 μMAX

## Selector Guide (continued)

PART	FILTER RESPONSE	OPERATING VOLTAGE (V)
MAX7422	r = 1.6	+3
MAX7423	Bessel	+3
MAX7424	Butterworth	+3
MAX7425	r = 1.25	+3

## Chip Information

TRANSISTOR COUNT: 1457

PROCESS: BiCMOS

# 5th-Order, Lowpass, Switched-Capacitor Filters

## Package Information

	INCHES		MILLIMETERS		JEDEC			
	MIN	MAX	MIN	MAX	MIN	MAX	MIN	MAX
A	0.037	0.043	0.94	1.10	---	0.043	---	1.10
A1	0.002	0.006	0.05	0.15	0.002	0.006	0.05	0.15
B	0.010	0.014	0.25	0.36	0.010	0.016	0.25	0.40
C	0.005	0.007	0.13	0.18	0.005	0.009	0.13	0.23
D	0.116	0.120	2.95	3.05	0.114	0.122	2.9	3.1
e	0.0256	BSC	0.65	BSC	0.0256	BSC	0.64	BSC
E	0.116	0.120	2.95	3.05	0.114	0.122	2.9	3.1
H	0.188	0.198	4.78	5.03	0.193	BSC	4.9	BSC
L	0.016	0.026	0.41	0.66	0.016	0.027	0.40	0.70
alpha	0°	6°	0°	6°	0°	6°	0°	6°
S	0.0207	BSC	0.5250	BSC				

**NOTES:**  
 1. D&E DO NOT INCLUDE MOLD FLASH.  
 2. MOLD FLASH OR PROTRUSIONS NOT TO EXCEED 0.15MM (.006").  
 3. CONTROLLING DIMENSION: MILLIMETERS.  
 4. MEETS JEDEC MO-187.

**MAXIM**  
 PROPRIETARY INFORMATION  
 TITLE:  
 PACKAGE OUTLINE, 8L uMAX  
 APPROVAL: \_\_\_\_\_ DOCUMENT CONTROL NO. 21-0036 REV I 1/1

8LUMAXD EPS

Maxim cannot assume responsibility for use of any circuitry other than circuitry entirely embodied in a Maxim product. No circuit patent licenses are implied. Maxim reserves the right to change the circuitry and specifications without notice at any time.

14 \_\_\_\_\_ **Maxim Integrated Products, 120 San Gabriel Drive, Sunnyvale, CA 94086 408-737-7600**