

MAXIM

Quad, 10-Bit, Low-Power, 2-Wire, Serial Voltage-Output DAC

General Description

The MAX5841 is a quad, 10-bit voltage output, digital-to-analog converter (DAC) with an I²C™-compatible, 2-wire interface that operates at clock rates up to 400kHz. The device operates from a single 2.7V to 5.5V supply and draws only 230µA at V_{DD} = 3.6V. A power-down mode decreases current consumption to less than 1µA. The MAX5841 features three software-selectable power-down output impedances: 100kΩ, 1kΩ, and high impedance. Other features include internal precision Rail-to-Rail® output buffers and a power-on reset (POR) circuit that powers up the DAC in the 100kΩ power-down mode.

The MAX5841 features a double-buffered I²C-compatible serial interface that allows multiple devices to share a single bus. All logic inputs are CMOS-logic compatible and buffered with Schmitt triggers, allowing direct interfacing to optocoupled and transformer-isolated interfaces. The MAX5841 minimizes digital noise feedthrough by disconnecting the clock (SCL) signal from the rest of the device when an address mismatch is detected.

The MAX5841 is specified over the extended temperature range of -40°C to +85°C and is available in a miniature 10-pin µMAX package. Refer to the MAX5842 data sheet for the 12-bit version.

Applications

- Digital Gain and Offset Adjustments
- Programmable Voltage and Current Sources
- Programmable Attenuation
- VCO/Varactor Diode Control
- Low-Cost Instrumentation
- Battery-Powered Equipment
- ATE

Pin Configuration

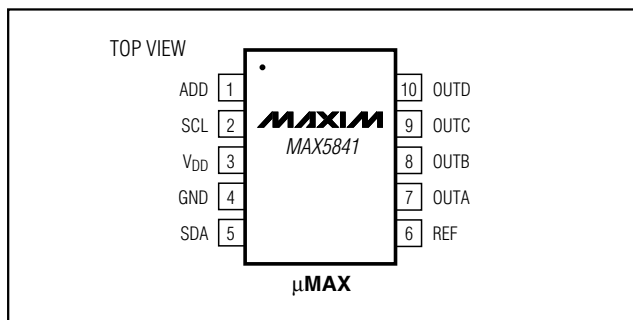

Rail-to-Rail is a registered trademark of Nippon Motorola, Ltd.
I²C is a trademark of Philips Corp.

Features

- ◆ Ultra-Low Supply Current
 - 230µA at V_{DD} = 3.6V
 - 280µA at V_{DD} = 5.5V
- ◆ 300nA Low-Power Power-Down Mode
- ◆ Single 2.7V to 5.5V Supply Voltage
- ◆ Fast 400kHz I²C-Compatible 2-Wire Serial Interface
- ◆ Schmitt-Trigger Inputs for Direct Interfacing to Optocouplers
- ◆ Rail-to-Rail Output Buffer Amplifiers
- ◆ Three Software-Selectable Power-Down Output Impedances
 - 100kΩ, 1kΩ, and High Impedance
- ◆ Read-Back Mode for Bus and Data Checking
- ◆ Power-On Reset to Zero
- ◆ 10-Pin µMAX Package

Ordering Information

PART	TEMP RANGE	PIN-PACKAGE	ADDRESS
MAX5841LEUB	-40°C to +85°C	10 µMAX	0111 10X
MAX5841MEUB	-40°C to +85°C	10 µMAX	1011 10X

Typical Operating Circuit

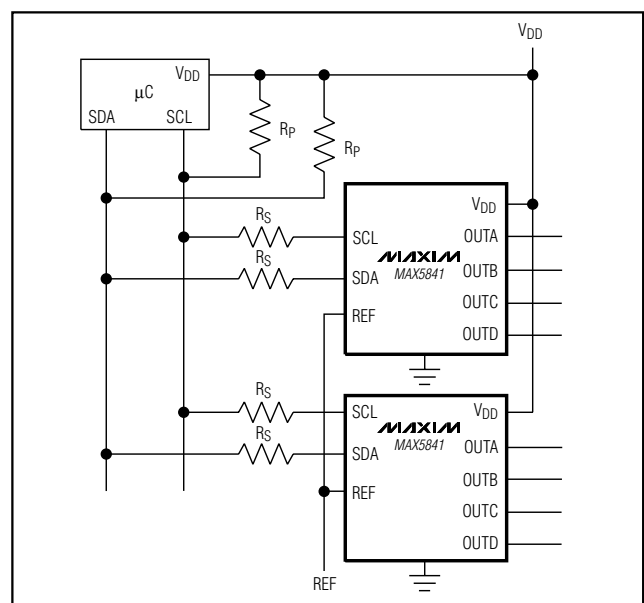
**MAXIM**

Maxim Integrated Products 1

For pricing, delivery, and ordering information, please contact Maxim/Dallas Direct! at 1-888-629-4642, or visit Maxim's website at www.maxim-ic.com.

MAX5841

Quad, 10-Bit, Low-Power, 2-Wire, Serial Voltage-Output DAC

ABSOLUTE MAXIMUM RATINGS

V _{DD} , SCL, SDA to GND	-0.3V to +6V	Operating Temperature Range	-40°C to +85°C
OUT ₋ , REF, ADD to GND.....	-0.3V to V _{DD} + 0.3V	Storage Temperature Range	-65°C to +150°C
Maximum Current into Any Pin.....	50mA	Maximum Junction Temperature	+150°C
Continuous Power Dissipation (T _A = +70°C)		Lead Temperature (soldering 10s)	+300°C
10-Pin μ MAX (derate 5.6mW above +70°C)	444mW		

Stresses beyond those listed under "Absolute Maximum Ratings" may cause permanent damage to the device. These are stress ratings only, and functional operation of the device at these or any other conditions beyond those indicated in the operational sections of the specifications is not implied. Exposure to absolute maximum rating conditions for extended periods may affect device reliability.

ELECTRICAL CHARACTERISTICS

(V_{DD} = +2.7V to +5.5V, GND = 0, V_{REF} = V_{DD}, R_L = 5k Ω , C_L = 200pF, T_A = T_{MIN} to T_{MAX}, unless otherwise noted. Typical values are at V_{DD} = +5V, T_A = +25°C.) (Note 1)

PARAMETER	SYMBOL	CONDITIONS	MIN	TYP	MAX	UNITS
STATIC ACCURACY (NOTE 2)						
Resolution	N		10			Bits
Integral Nonlinearity	INL	(Note 3)		± 0.5	± 4	LSB
Differential Nonlinearity	DNL	Guaranteed monotonic (Note 3)			± 0.5	LSB
Zero-Code Error	ZCE	Code = 000 hex, V _{DD} = 2.7V		6	40	mV
Zero-Code Error Tempco				2.3		ppm/°C
Gain Error	GE	Code = 3FF hex		-0.8	-3	%FSR
Gain-Error Tempco				0.26		ppm/°C
Power-Supply Rejection Ratio	PSRR	Code = 3FF hex, V _{DD} = 4.5V to 5.5V		58.8		dB
DC Crosstalk				30		μ V
REFERENCE INPUT						
Reference Input Voltage Range	V _{REF}		0		V _{DD}	V
Reference Input Impedance			32	45		k Ω
Reference Current		Power-down mode		± 0.3	± 1	μ A
DAC OUTPUT						
Output Voltage Range		No load (Note 4)	0		V _{DD}	V
DC Output Impedance		Code = 200 hex		1.2		Ω
Short-Circuit Current		V _{DD} = 5V, V _{OUT} = full scale (short to GND)		42.2		mA
		V _{DD} = 3V, V _{OUT} = full scale (short to GND)		15.1		
Wake-Up Time		V _{DD} = 5V		8		μ s
		V _{DD} = 3V		8		
DAC Output Leakage Current		Power-down mode = high impedance, V _{DD} = 5.5V, V _{OUT-} = V _{DD} or GND		± 0.1	± 1	μ A
DIGITAL INPUTS (SCL, SDA)						
Input High Voltage	V _{IH}		0.7 \times V _{DD}			V
Input Low Voltage	V _{IL}				0.3 \times V _{DD}	V

Quad, 10-Bit, Low-Power, 2-Wire, Serial Voltage-Output DAC

MAX5841

ELECTRICAL CHARACTERISTICS (continued)

($V_{DD} = +2.7V$ to $+5.5V$, $GND = 0$, $V_{REF} = V_{DD}$, $R_L = 5k\Omega$, $C_L = 200pF$, $T_A = T_{MIN}$ to T_{MAX} , unless otherwise noted. Typical values are at $V_{DD} = +5V$, $T_A = 25^\circ C$.)

PARAMETER	SYMBOL	CONDITIONS	MIN	TYP	MAX	UNITS
Input Hysteresis			$0.05 \times V_{DD}$			V
Input Leakage Current		Digital inputs = 0 or V_{DD}		± 0.1	± 1	μA
Input Capacitance				6		pF
DIGITAL OUTPUT (SDA)						
Output Logic Low Voltage	V_{OL}	$I_{SINK} = 3mA$			0.4	V
Three-State Leakage Current	I_L	Digital inputs = 0 or V_{DD}		± 0.1	± 1	μA
Three-State Output Capacitance				6		pF
DYNAMIC PERFORMANCE						
Voltage Output Slew Rate	SR			0.5		$V/\mu s$
Voltage Output Settling Time		To 1/2LSB code 100 hex to 300 hex or 300 hex to 100 hex (Note 5)		4	12	μs
Digital Feedthrough		Code = 000 hex, digital inputs from 0 to V_{DD}		0.2		nV-s
Digital-to-Analog Glitch Impulse		Major carry transition (code = 1FF hex to 200 hex and 200 hex to 1FF hex)		12		nV-s
DAC-to-DAC Crosstalk				2.4		nV-s
POWER SUPPLIES						
Supply Voltage Range	V_{DD}		2.7		5.5	V
Supply Current with No Load	I_{DD}	All digital inputs at 0 or $V_{DD} = 3.6V$		230	395	μA
		All digital inputs at 0 or $V_{DD} = 5.5V$		280	420	
Power-Down Supply Current	I_{DDPD}	All digital inputs at 0 or $V_{DD} = 5.5V$		0.3	1	μA
TIMING CHARACTERISTICS (FIGURE 1)						
Serial Clock Frequency	f_{SCL}		0		400	kHz
Bus Free Time Between STOP and START Conditions	t_{BUF}		1.3			μs
START Condition Hold Time	$t_{HD,STA}$		0.6			μs
SCL Pulse Width Low	t_{LOW}		1.3			μs
SCL Pulse Width High	t_{HIGH}		0.6			μs
Repeated START Setup Time	$t_{SU,STA}$		0.6			μs
Data Hold Time	$t_{HD,DAT}$		0		0.9	μs
Data Setup Time	$t_{SU,DAT}$		100			ns
SDA and SCL Receiving Rise Time	t_r	(Note 5)	0		300	ns
SDA and SCL Receiving Fall Time	t_f	(Note 5)	0		300	ns
SDA Transmitting Fall Time	t_f	(Note 5)	$20 + 0.1C_b$		250	ns
STOP Condition Setup Time	$t_{SU,STO}$		0.6			μs

Quad, 10-Bit, Low-Power, 2-Wire, Serial Voltage-Output DAC

ELECTRICAL CHARACTERISTICS (continued)

($V_{DD} = +2.7V$ to $+5.5V$, $GND = 0$, $V_{REF} = V_{DD}$, $R_L = 5k\Omega$, $C_L = 200pF$, $T_A = T_{MIN}$ to T_{MAX} , unless otherwise noted. Typical values are at $V_{DD} = +5V$, $T_A = 25^\circ C$.)

PARAMETER	SYMBOL	CONDITIONS	MIN	TYP	MAX	UNITS
Bus Capacitance	C_b	(Note 5)			400	pF
Maximum Duration of Suppressed Pulse Widths	t_{SP}		0		50	ns

Note 1: All devices are 100% production tested at $T_A = +25^\circ C$ and are guaranteed by design for $T_A = T_{MIN}$ to T_{MAX} .

Note 2: Static specifications are tested with the output unloaded.

Note 3: Linearity is guaranteed from codes 29 to 995.

Note 4: Offset and gain error limit the FSR.

Note 5: Guaranteed by design. Not production tested.

Typical Operating Characteristics

($V_{DD} = +5V$, $R_L = 5k\Omega$, $T_A = +25^\circ C$.)

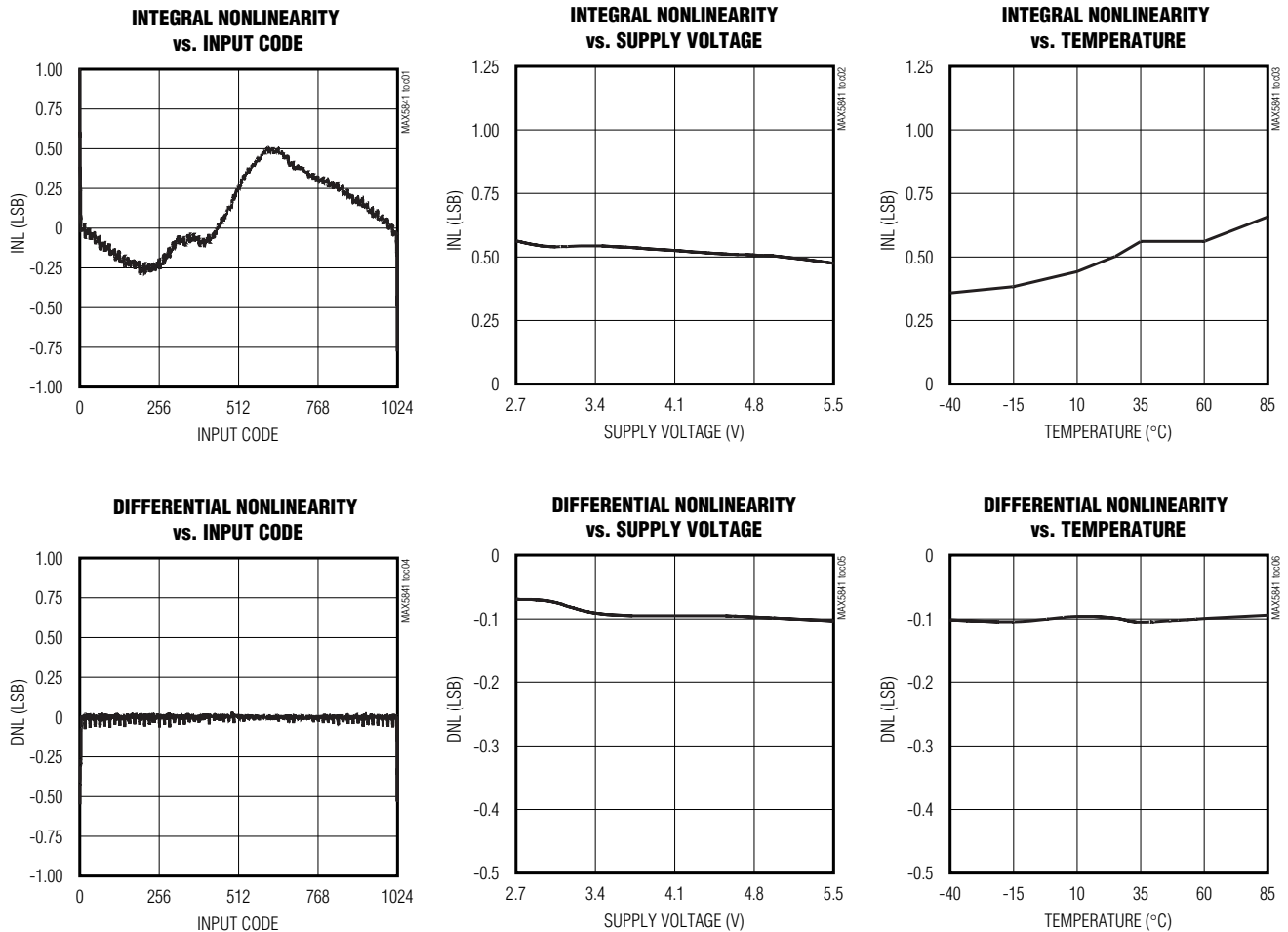

Quad, 10-Bit, Low-Power, 2-Wire, Serial Voltage-Output DAC

MAX5841

Typical Operating Characteristics (continued)

($V_{DD} = +5V$, $R_L = 5k\Omega$, $T_A = +25^\circ C$.)

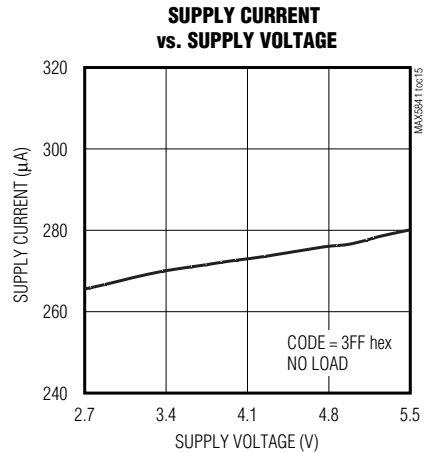
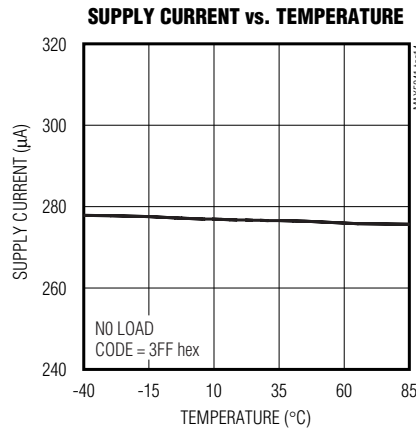
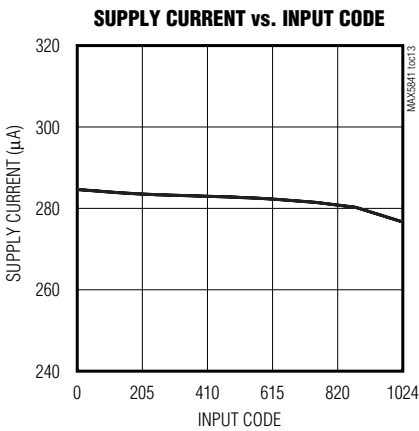
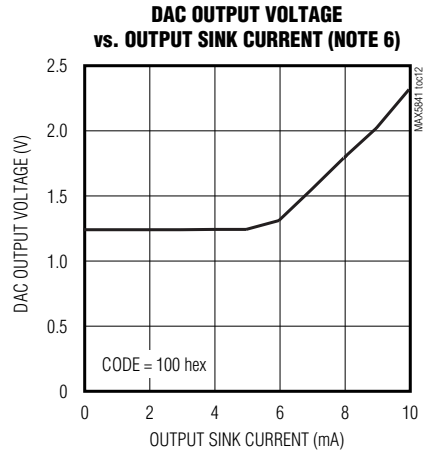
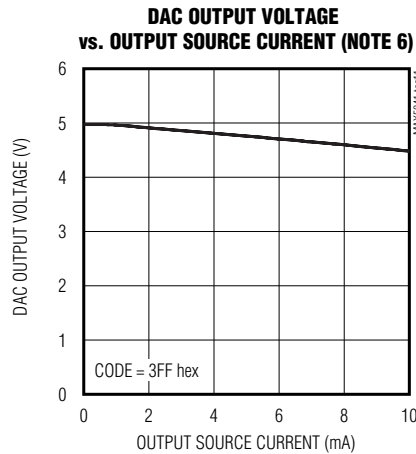
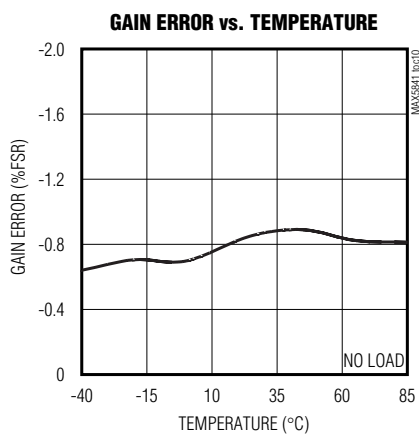
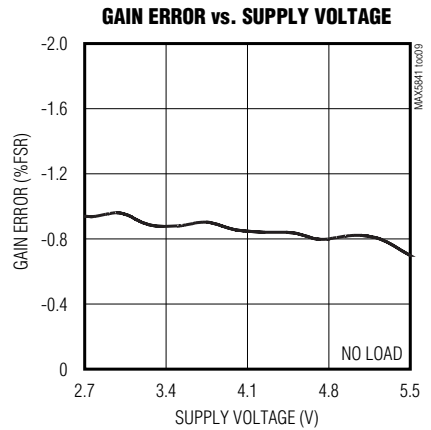
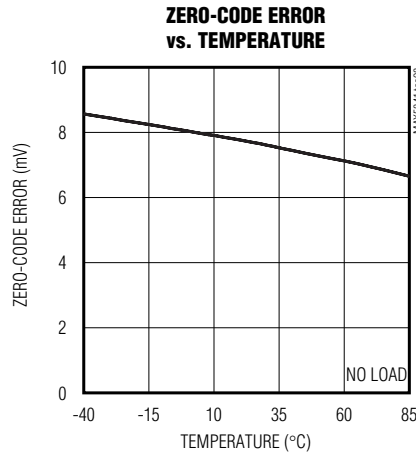
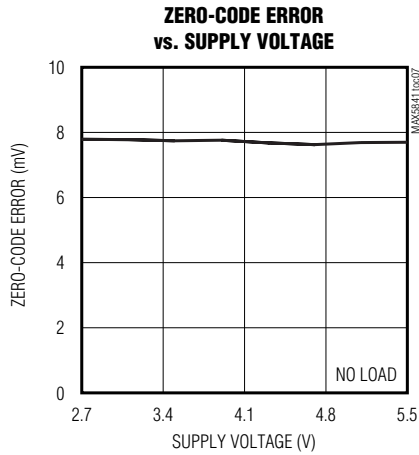

Quad, 10-Bit, Low-Power, 2-Wire, Serial Voltage-Output DAC

Typical Operating Characteristics (continued)

($V_{DD} = +5V$, $R_L = 5k\Omega$, $T_A = +25^\circ C$.)

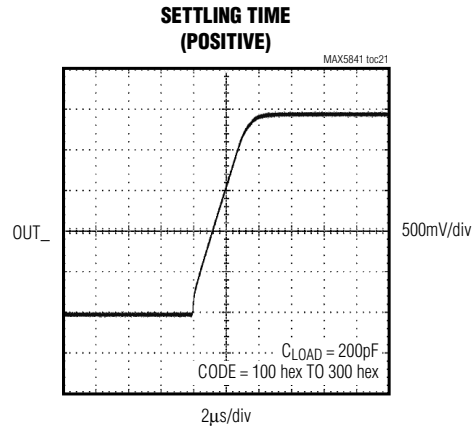
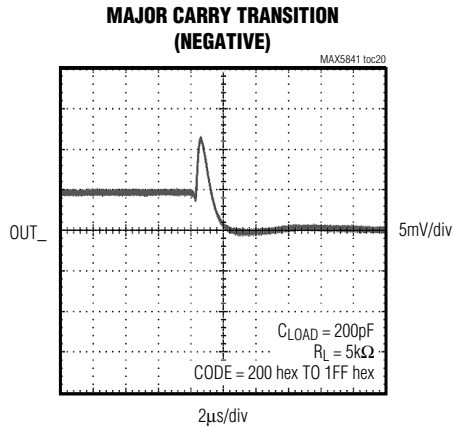
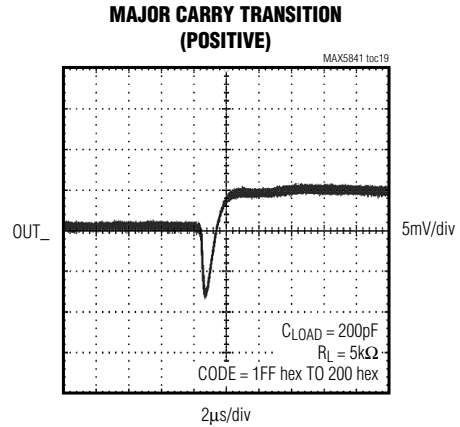
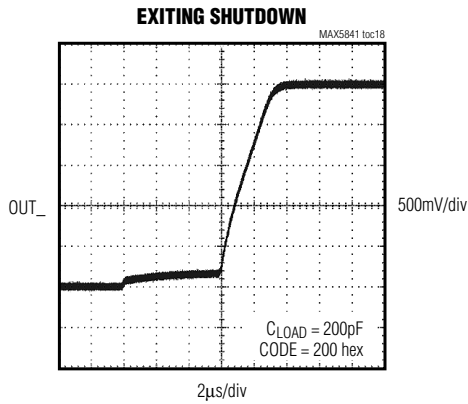
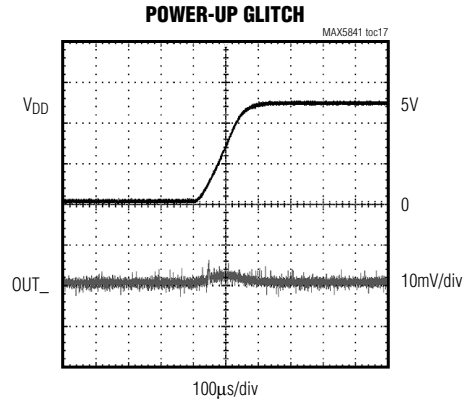
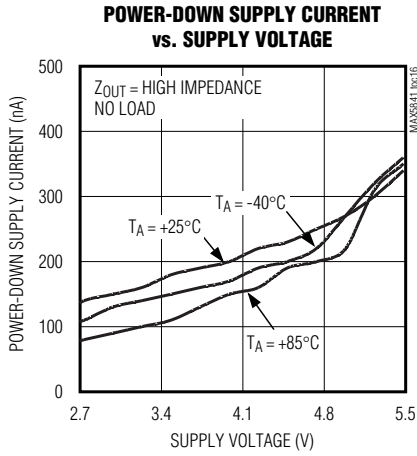

Quad, 10-Bit, Low-Power, 2-Wire, Serial Voltage-Output DAC

MAX5841

Typical Operating Characteristics (continued)

($V_{DD} = +5V$, $R_L = 5k\Omega$, $T_A = +25^\circ C$.)

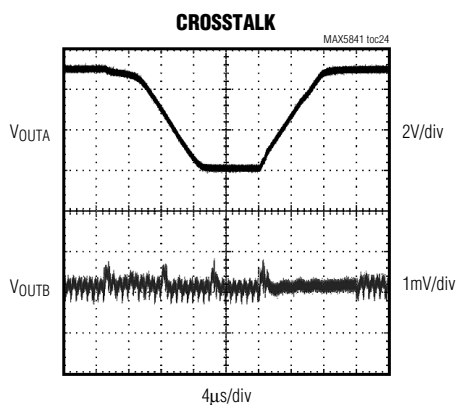
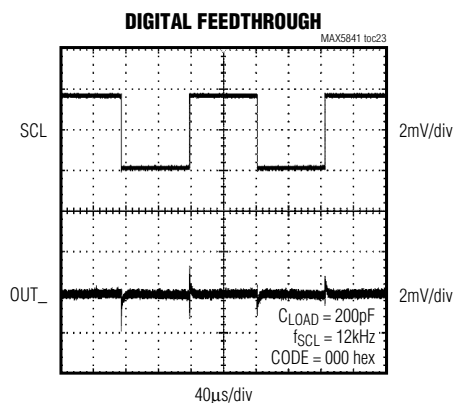
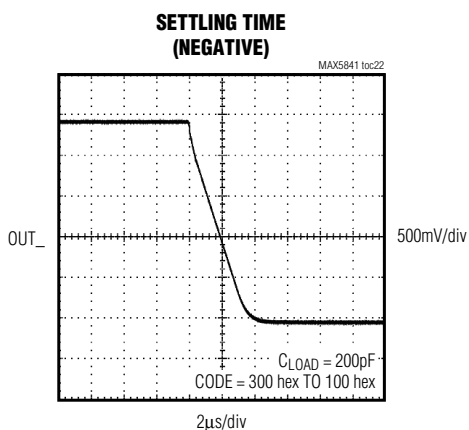

Note 6: The ability to drive loads less than $5k\Omega$ is not implied.

Quad, 10-Bit, Low-Power, 2-Wire, Serial Voltage-Output DAC

Pin Description

PIN	NAME	FUNCTION
1	ADD	Address Select. A logic high sets the address LSB to 1; a logic low sets the address LSB to zero.
2	SCL	Serial Clock Input
3	V _{DD}	Power Supply
4	GND	Ground
5	SDA	Bidirectional Serial Data Interface
6	REF	Reference Input
7	OUTA	DAC A Output
8	OUTB	DAC B Output
9	OUTC	DAC C Output
10	OUTD	DAC D Output

Detailed Description

The MAX5841 is a quad, 10-bit, voltage-output DAC with an I²C/SMBus-compatible 2-wire interface. The device consists of a serial interface, power-down circuitry, four input and DAC registers, four 10-bit resistor string DACs, four unity-gain output buffers, and output resistor networks. The serial interface decodes the address and control bits, routing the data to the proper input or DAC register. Data can be directly written to the DAC register, immediately updating the device output, or can be written to the input register without changing the DAC output. Both registers retain data as long as the device is powered.

DAC Operation

The MAX5841 uses a segmented resistor string DAC architecture, which saves power in the overall system and guarantees output monotonicity. The MAX5841's input coding is straight binary, with the output voltage given by the following equation:

$$V_{OUT} = \frac{V_{REF} \times (D)}{2^N}$$

where N = 10 (bits), and D = the decimal value of the input code (0 to 1023).

Output Buffer

The MAX5841 analog outputs are buffered by precision, unity-gain followers that slew 0.5V/μs. Each buffer output swings rail-to-rail, and is capable of driving 5kΩ in parallel with 200pF. The output settles to ±0.5LSB within 4μs.

Power-On Reset

The MAX5841 features an internal POR circuit that initializes the device upon power-up. The DAC registers

are set to zero scale and the device is powered down, with the output buffers disabled and the outputs pulled to GND through the 100kΩ termination resistor. Following power-up, a wake-up command must be initiated before any conversions are performed.

Power-Down Modes

The MAX5841 has three software-controlled low-power power-down modes. All three modes disable the output buffers and disconnect the DAC resistor strings from REF, reducing supply current draw to 1μA and the reference current draw to less than 1μA. In power-down mode 0, the device output is high impedance. In power-down mode 1, the device output is internally pulled to GND by a 1kΩ termination resistor. In power-down mode 2, the device output is internally pulled to GND by a 100kΩ termination resistor. Table 1 shows the power-down mode command words.

Upon wake-up, the DAC output is restored to its previous value. Data is retained in the input and DAC registers during power-down mode.

Digital Interface

The MAX5841 features an I²C/SMBus-compatible 2-wire interface consisting of a serial data line (SDA) and a serial clock line (SCL). The MAX5841 is SMBus compatible within the range of V_{DD} = 2.7V to 3.6V. SDA and SCL facilitate bidirectional communication between the MAX5841 and the master at rates up to 400kHz. Figure 1 shows the 2-wire interface timing diagram. The MAX5841 is a transmit/receive slave-only device, relying upon a master to generate a clock signal. The master (typically a microcontroller) initiates data transfer on the bus and generates SCL to permit that transfer.

A master device communicates to the MAX5841 by transmitting the proper address followed by command and/or data words. Each transmit sequence is framed-

Quad, 10-Bit, Low-Power, 2-Wire, Serial Voltage-Output DAC

Table 1. Power-Down Command Bits

POWER-DOWN COMMAND BITS		MODE/FUNCTION
PD1	PD0	
0	0	Power-up device. DAC output restored to previous value.
0	1	Power-down mode 0. Power down device with output floating.
1	0	Power-down mode 1. Power down device with output terminated with 1kΩ to GND.
1	1	Power-down mode 2. Power down device with output terminated with 100kΩ to GND.

by a START (S) or REPEATED START (S_R) condition and a STOP (P) condition. Each word transmitted over the bus is 8 bits long and is always followed by an acknowledge clock pulse.

The MAX5841 SDA and SCL drivers are open-drain outputs, requiring a pullup resistor to generate a logic high voltage (see *Typical Operating Circuit*). Series resistors R_S are optional. These series resistors protect the input stages of the MAX5841 from high-voltage spikes on the bus lines, and minimize crosstalk and undershoot of the bus signals.

Bit Transfer

One data bit is transferred during each SCL clock cycle. The data on SDA must remain stable during the high period of the SCL clock pulse. Changes in SDA while SCL is high are control signals (see *START and*

STOP Conditions). Both SDA and SCL idle high when the I²C bus is not busy.

START and STOP Conditions

When the serial interface is inactive, SDA and SCL idle high. A master device initiates communication by issuing a START condition. A START condition is a high-to-low transition on SDA with SCL high. A STOP condition is a low-to-high transition on SDA, while SCL is high (Figure 2). A START condition from the master signals the beginning of a transmission to the MAX5841. The master terminates transmission by issuing a not acknowledge followed by a STOP condition (see *Acknowledge Bit (ACK)*). The STOP condition frees the bus. If a repeated START condition (S_R) is generated instead of a STOP condition, the bus remains active. When a STOP condition or incorrect address is detected, the MAX5841 internally disconnects SCL from the serial interface until the next START condition, minimizing digital noise and feedthrough.

Early STOP Conditions

The MAX5841 recognizes a STOP condition at any point during transmission except if a STOP condition occurs in the same high pulse as a START condition (Figure 3). This condition is not a legal I²C format; at least one clock pulse must separate any START and STOP conditions.

Repeated START Conditions

A REPEATED START (S_R) condition may indicate a change of data direction on the bus. Such a change occurs when a command word is required to initiate a read operation. S_R may also be used when the bus master is writing to several I²C devices and does not want to relinquish control of the bus. The MAX5841 serial interface supports continuous write operations with or without an S_R condition separating them. Continuous

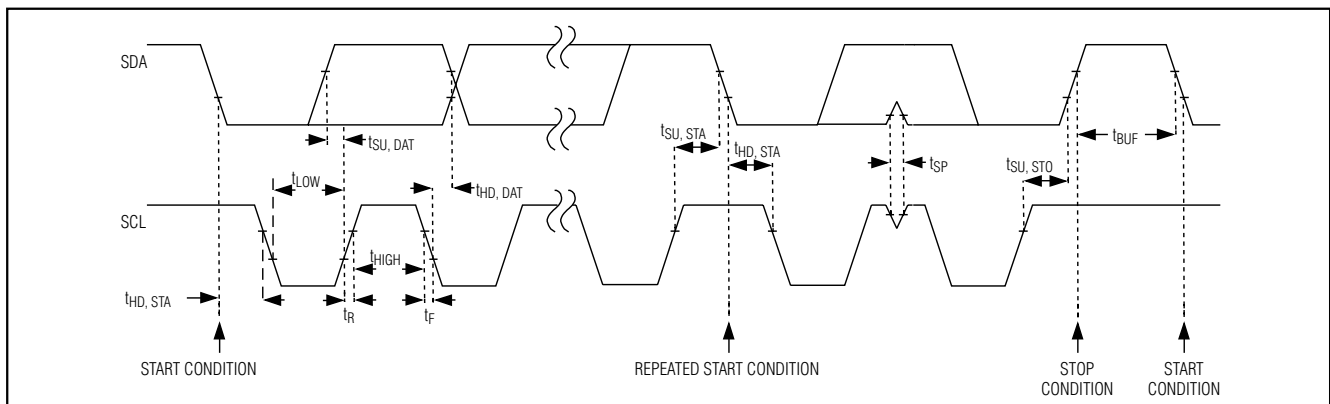

Figure 1. 2-Wire Serial Interface Timing Diagram

Quad, 10-Bit, Low-Power, 2-Wire, Serial Voltage-Output DAC

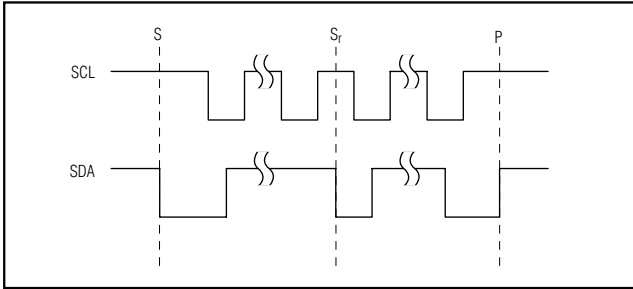

Figure 2. START and STOP Conditions

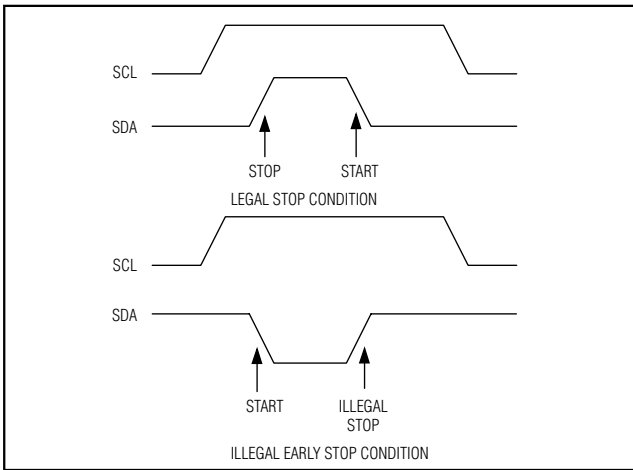

Figure 3. Early STOP Conditions

read operations require S_r conditions because of the change in direction of data flow.

Acknowledge Bit (ACK)

The acknowledge bit (ACK) is the ninth bit attached to any 8-bit data word. ACK is always generated by the receiving device. The MAX5841 generates an ACK when receiving an address or data by pulling SDA low during the ninth clock period. When transmitting data, the MAX5841 waits for the receiving device to generate an ACK. Monitoring ACK allows for detection of unsuccessful data transfers. An unsuccessful data transfer occurs if a receiving device is busy or if a system fault has occurred. In the event of an unsuccessful data transfer, the bus master should reattempt communication at a later time.

Slave Address

A bus master initiates communication with a slave device by issuing a START condition followed by the 7-bit slave address (Figure 4). When idle, the MAX5841 waits for a START condition followed by its slave

address. The serial interface compares each address value bit by bit, allowing the interface to power down immediately if an incorrect address is detected. The LSB of the address word is the Read/Write (R/W) bit. R/\bar{W} indicates whether the master is writing to or reading from the MAX5841 ($R/\bar{W} = 0$ selects the write condition, $R/\bar{W} = 1$ selects the read condition). After receiving the proper address, the MAX5841 issues an ACK by pulling SDA low for one clock cycle.

The MAX5841 has four different factory/user-programmed addresses (Table 2). Address bits A6 through A1 are preset, while A0 is controlled by ADD. Connecting ADD to GND sets $A_0 = 0$. Connecting ADD to V_{DD} sets $A_0 = 1$. This feature allows up to four MAX5841s to share the same bus.

Table 2. MAX5841 I²C Slave Addresses

PART	V_{ADD}	DEVICE ADDRESS (A6...A0)
MAX5841L	GND	0111 100
MAX5841L	V_{DD}	0111 101
MAX5841M	GND	1011 100
MAX5841M	V_{DD}	1011 101

Write Data Format

In write mode ($R/\bar{W} = 0$), data that follows the address byte controls the MAX5841 (Figure 5). Bits C3–C0 configure the MAX5841 (Table 3). Bits D9–D0 are DAC data. Bits S0 and S1 are sub-bits and are always zero. Input and DAC registers update on the falling edge of SCL during the acknowledge bit. Should the write cycle be prematurely aborted, data is not updated and the write cycle must be repeated. Figure 6 shows two example write data sequences.

Extended Command Mode

The MAX5841 features an extended command mode that is accessed by setting $C_3-C_0 = 1$ and $D_9-D_6 = 0$. The next data byte writes to the shutdown registers (Figure 7). Setting bits A, B, C, or D to 1 sets that DAC

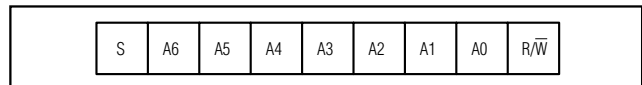

Figure 4. Slave Address Byte Definition

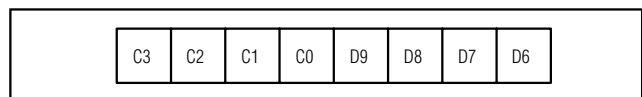

Figure 5. Command Byte Definition

Quad, 10-Bit, Low-Power, 2-Wire, Serial Voltage-Output DAC

MAX5841

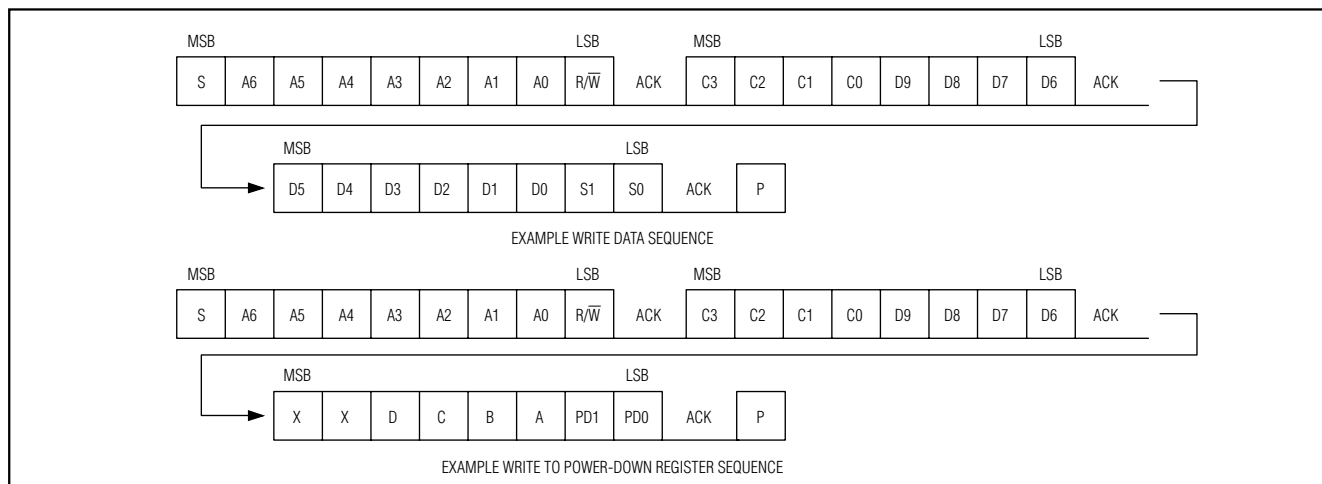

Figure 6. Example Write Command Sequences

to the selected power-down mode based on the states of PD0 and PD1 (Table 1). Any combination of the four DACs can be controlled with a single write sequence.

Read Data Format

In read mode ($\overline{R/W} = 1$), the MAX5841 writes the contents of the DAC register to the bus. The direction of data flow reverses following the address acknowledge by the MAX5841. The device transmits the first byte of data, waits for the master to acknowledge, then transmits the second byte. Figure 8 shows an example read data sequence.

I²C Compatibility

The MAX5841 is compatible with existing I²C systems. SCL and SDA are high-impedance inputs; SDA has an open drain that pulls the data line low during the ninth clock pulse. The *Typical Operating Circuit* shows a typical I²C application. The communication protocol supports the standard I²C 8-bit communications. The general call address is ignored. The MAX5841 address is compatible with the 7-bit I²C addressing protocol only. No 10-bit address formats are supported.

Digital Feedthrough Suppression

When the MAX5841 detects an address mismatch, the serial interface disconnects the SCL signal from the core circuitry. This minimizes digital feedthrough caused by the SCL signal on a static output. The serial interface reconnects the SCL signal once a valid START condition is detected.

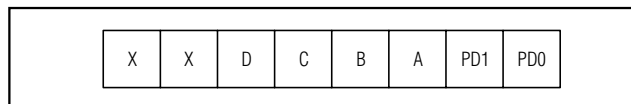

Figure 7. Extended Command Byte Definition

Applications Information

Digital Inputs and Interface Logic

The MAX5841 2-wire digital interface is I²C/SMBus compatible. The two digital inputs (SCL and SDA) load the digital input serially into the DAC. Schmitt-trigger buffered inputs allow slow-transition interfaces such as optocouplers to interface directly to the device. The digital inputs are compatible with CMOS logic levels.

Power-Supply Bypassing and Ground Management

Careful PC board layout is important for optimal system performance. Keep analog and digital signals separate to reduce noise injection and digital feedthrough. Use a ground plane to ensure that the ground return from GND to the power-supply ground is short and low impedance. Bypass V_{DD} with a 0.1μF capacitor to ground as close to the device as possible.

Chip Information

TRANSISTOR COUNT: 17,213

PROCESS: BiCMOS

Quad, 10-Bit, Low-Power, 2-Wire, Serial Voltage-Output DAC

Table 3. Command Byte Definitions

SERIAL DATA INPUT								FUNCTION
C3	C2	C1	C0	D9	D8	D7	D6	
0	0	0	0	DAC DATA	DAC DATA	DAC DATA	DAC DATA	Load DAC A input and DAC registers with new data. Contents of DAC B, C, and D input registers are transferred to the respective DAC registers. All outputs are updated.
0	0	0	1	DAC DATA	DAC DATA	DAC DATA	DAC DATA	Load DAC B input and DAC registers with new data. Contents of DAC A, C, and D input registers are transferred to the respective DAC registers. All outputs are updated.
0	0	1	0	DAC DATA	DAC DATA	DAC DATA	DAC DATA	Load DAC C input and DAC registers with new data. Contents of DAC A, B, and D input registers are transferred to the respective DAC registers. All outputs are updated.
0	0	1	1	DAC DATA	DAC DATA	DAC DATA	DAC DATA	Load DAC D input and DAC registers with new data. Contents of DAC A, B, and C input registers are transferred to the respective DAC registers. All outputs are updated simultaneously.
0	1	0	0	DAC DATA	DAC DATA	DAC DATA	DAC DATA	Load DAC A input register with new data. DAC outputs remain unchanged.
0	1	0	1	DAC DATA	DAC DATA	DAC DATA	DAC DATA	Load DAC B input register with new data. DAC outputs remain unchanged.
0	1	1	0	DAC DATA	DAC DATA	DAC DATA	DAC DATA	Load DAC C input register with new data. DAC outputs remain unchanged.
0	1	1	1	DAC DATA	DAC DATA	DAC DATA	DAC DATA	Load DAC D input register with new data. DAC outputs remain unchanged.
1	0	0	0	DAC DATA	DAC DATA	DAC DATA	DAC DATA	Data in all input registers is transferred to respective DAC registers. All DAC outputs are updated simultaneously. New data is loaded into DAC A input register.
1	0	0	1	DAC DATA	DAC DATA	DAC DATA	DAC DATA	Data in all input registers is transferred to respective DAC registers. All DAC outputs are updated simultaneously. New data is loaded into DAC B input register.
1	0	1	0	DAC DATA	DAC DATA	DAC DATA	DAC DATA	Data in all input registers is transferred to respective DAC registers. All DAC outputs are updated simultaneously. New data is loaded into DAC C input register.
1	0	1	1	DAC DATA	DAC DATA	DAC DATA	DAC DATA	Data in all input registers is transferred to respective DAC registers. All DAC outputs are updated simultaneously. New data is loaded into DAC D input register.
1	1	0	0	DAC DATA	DAC DATA	DAC DATA	DAC DATA	Load all DACs with new data and update all DAC outputs simultaneously. Input and DAC registers are updated with new data.
1	1	0	1	DAC DATA	DAC DATA	DAC DATA	DAC DATA	Load all input registers with new data. DAC outputs remain unchanged.

Quad, 10-Bit, Low-Power, 2-Wire, Serial Voltage-Output DAC

MAX5841

Table 3. Command Byte Definitions (continued)

SERIAL DATA INPUT								FUNCTION
C3	C2	C1	C0	D9	D8	D7	D6	
1	1	1	0	X	X	X	X	Update all DAC outputs simultaneously. Device ignores D9-D6. Do not send the data byte.
1	1	1	1	0	0	0	0	Extended command mode. The next word writes to the power-down registers (<i>Extended Command Mode</i>).
1	1	1	1	0	0	0	1	Read DAC A data. The device expects an S_r condition followed by an address word with $R/\overline{W} = 1$.
1	1	1	1	0	0	1	0	Read DAC B data. The device expects an S_r condition followed by an address word with $R/\overline{W} = 1$.
1	1	1	1	0	1	0	0	Read DAC C data. The device expects an S_r condition followed by an address word with $R/\overline{W} = 1$.
1	1	1	1	1	0	0	0	Read DAC D data. The device expects an S_r condition followed by an address word with $R/\overline{W} = 1$.

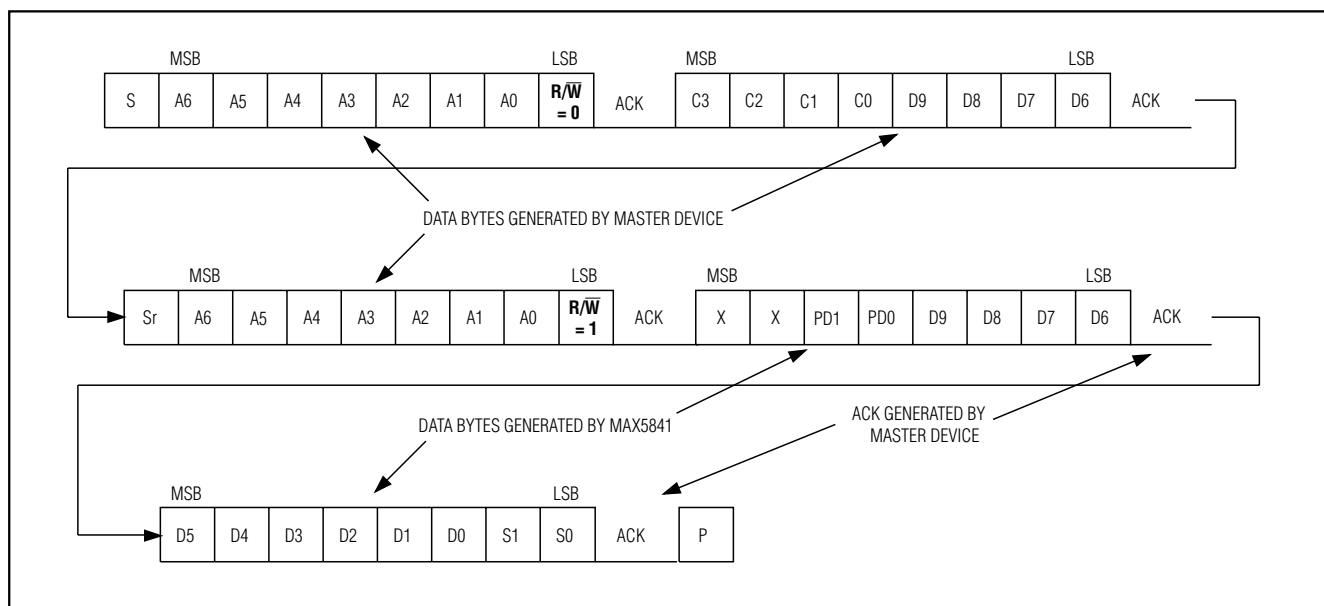
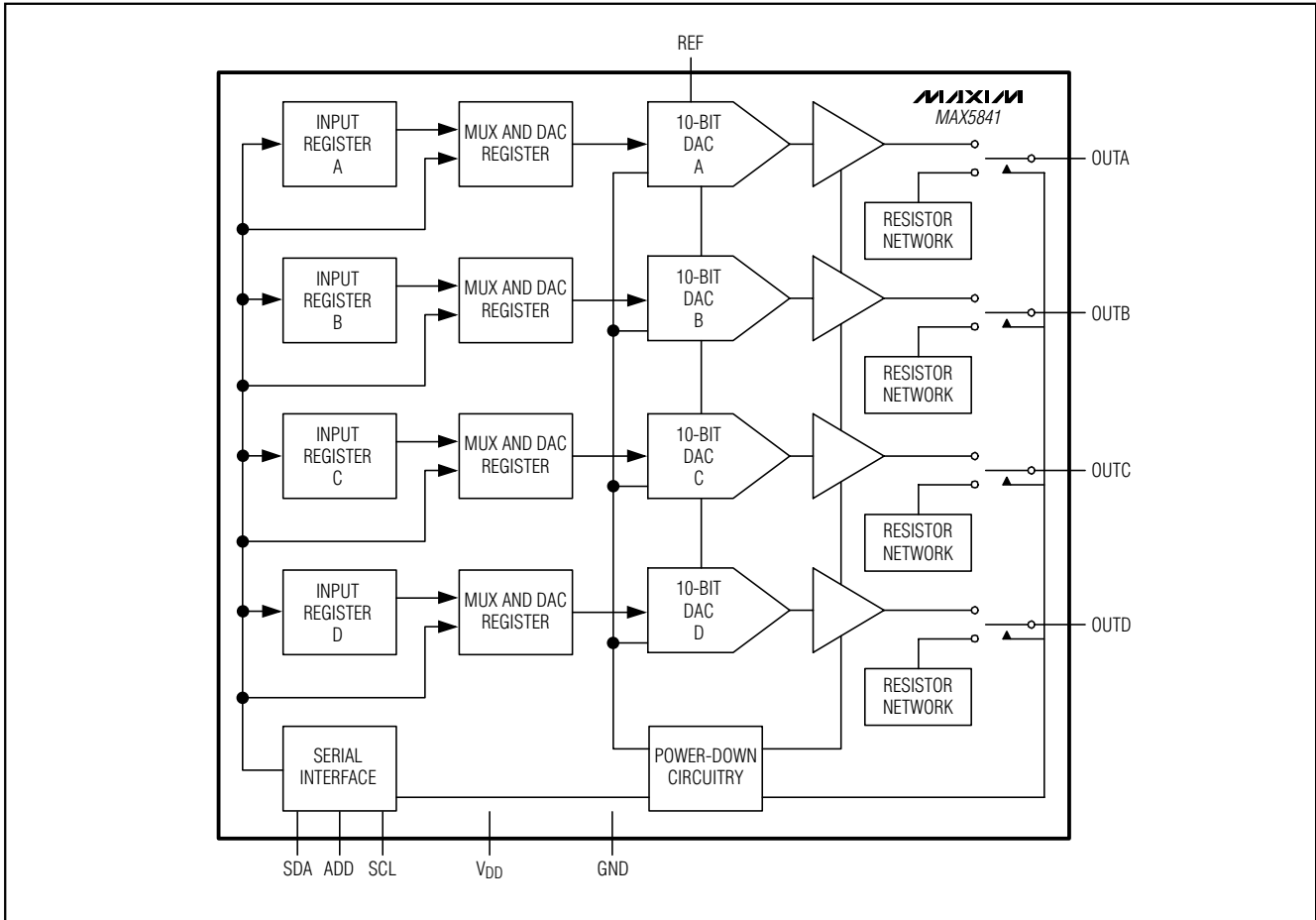

Figure 8. Example Read Word Data Sequence

Quad, 10-Bit, Low-Power, 2-Wire, Serial Voltage-Output DAC

Functional Diagram



Quad, 10-Bit, Low-Power, 2-Wire, Serial Voltage-Output DAC

Package Information

MAX5841

10LUMAX.EPS

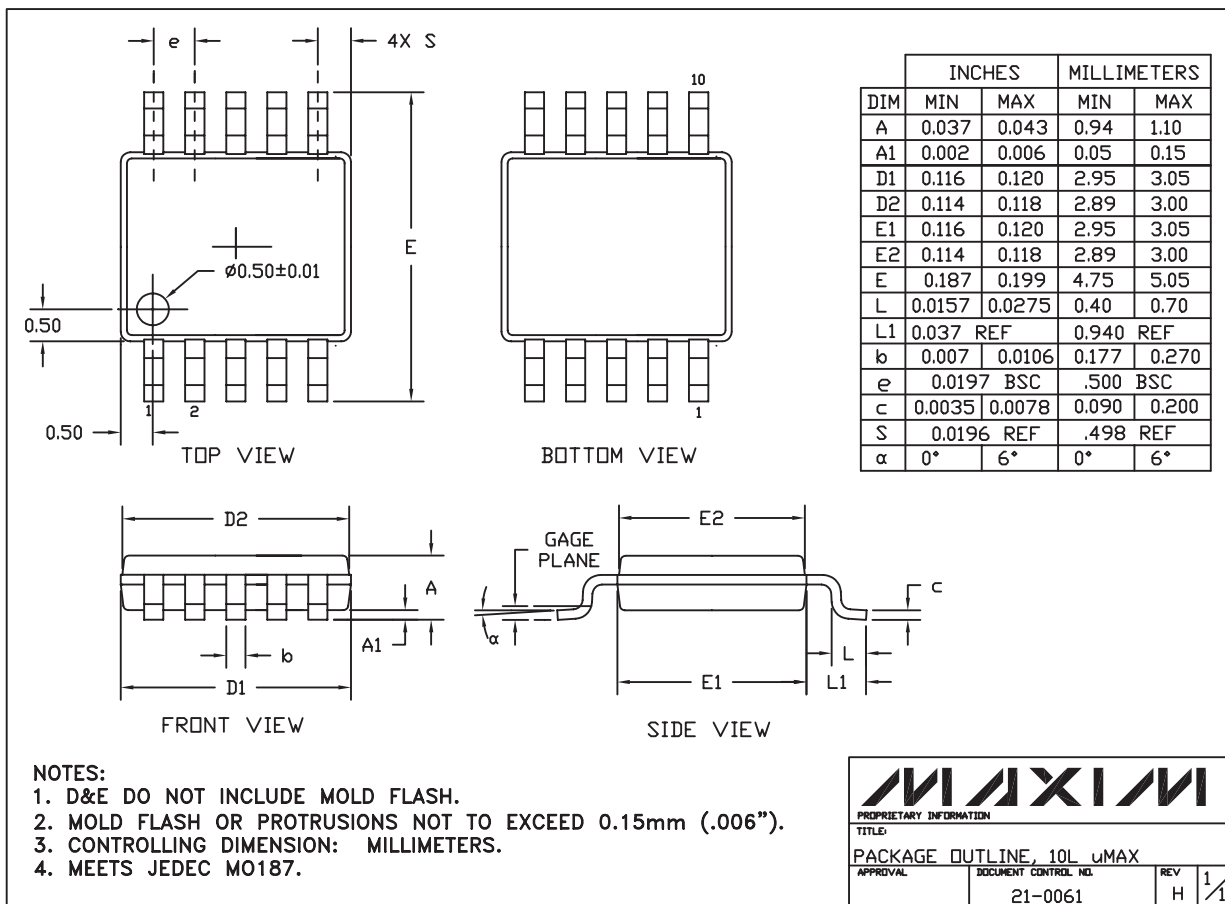

Maxim cannot assume responsibility for use of any circuitry other than circuitry entirely embodied in a Maxim product. No circuit patent licenses are implied. Maxim reserves the right to change the circuitry and specifications without notice at any time.

Maxim Integrated Products, 120 San Gabriel Drive, Sunnyvale, CA 94086 408-737-7600 15