

MAXIM

1.2 μ A Max, Single/Dual/Quad, Single-Supply Op Amps

General Description

The MAX406/MAX407/MAX409/MAX417-MAX419 are single, dual, and quad low-voltage, micropower, precision op amps designed for battery-operated systems. They feature a supply current of less than 1.2 μ A per amplifier that is relatively constant over the entire supply range, which represents a 15 to 20 times improvement over industry-standard micropower op amps. A unique output stage enables these op amps to operate at ultra-low supply current while maintaining linearity under loaded conditions. In addition, the output is capable of sourcing 1.8mA when powered by a 9V battery.

The common-mode input-voltage range extends from the negative rail to within 1.1V of the positive supply (for the singles, 1.2V for the duals and quads), and the output stage swings rail-to-rail. The entire family is designed to maintain good DC characteristics over the operating temperature range, minimizing the input referred errors.

The MAX406 is a single op amp with two modes of operation: compensated mode and decompensated mode. Floating BW (pin 8) or connecting it to V- internally compensates the amplifier. In this mode, the MAX406 is unity-gain stable with a 5V/ms typical slew rate and an 8kHz gain bandwidth. Connecting BW to V+ puts the MAX406 into decompensated mode with a 20V/ms typical slew rate and a 40kHz gain bandwidth ($A_{VCL} \geq 2V/V$).

The dual MAX407 and quad MAX418 are internally compensated to be unity-gain stable. The MAX409/MAX417/MAX419 single/dual/quad op amps feature 150kHz typical bandwidth, 75V/ms slew rate, and stability for gains of 10V/V or greater.

Applications

Battery-Powered Systems
 Medical Instruments
 Electrometer Amplifiers
 Intrinsically Safe Systems
 Photodiode Pre-Amps
 pH Meters

Features

- ◆ 1.2 μ A Max Quiescent Current per Amplifier
- ◆ +2.5V to +10V Single-Supply Range
- ◆ 500 μ V Max Offset Voltage (MAX406A/MAX409A)
- ◆ < 0.1pA Typical Input Bias Current
- ◆ Output Swings Rail-to-Rail
- ◆ Input Voltage Range Includes Negative Rail

Selection Table

PART NUMBER	NO. OF AMPLIFIERS	GAIN-BW PRODUCT (kHz, TYP)	GAIN STABILITY (V/V)	OFFSET VOLTAGE (mV, MAX)
MAX406A	1	8*/40**	1*/2**	0.5
MAX406B	1	8*/40**	1*/2**	2.0
MAX407	2	8	1	3.0
MAX409A	1	150	10	0.5
MAX409B	1	150	10	2.0
MAX417	2	150	10	3.0
MAX418	4	8	1	4.0
MAX419	4	150	10	4.0

* With BW pin open or connected to V-

** With BW pin connected to V+

Ordering Information appears at end of data sheet.

Typical Operating Circuit

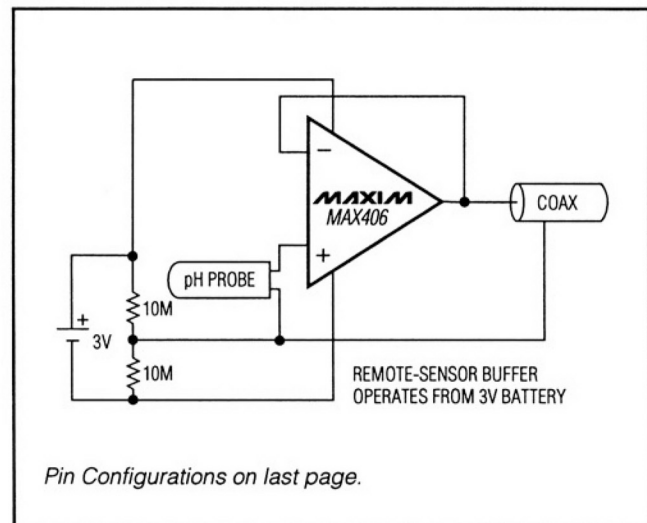
MAX406/MAX407/MAX409/MAX417-MAX419
MAXIM

Maxim Integrated Products 1

For pricing, delivery, and ordering information, please contact Maxim Direct at 1-888-629-4642, or visit Maxim's website at www.maxim-ic.com.

1.2μA Max, Single/Dual/Quad, Single-Supply Op Amps

ABSOLUTE MAXIMUM RATINGS

Total Supply Voltage (V+ to V-)	12V	14-Pin Plastic DIP (derate 10.00mW/°C above +70°C)	800mW
Input Voltage (V+ to V-)	(V+ + 0.3V) to (V- - 0.3V)	14-Pin SO (derate 8.33mW/°C above +70°C)	667mW
Continuous Current		14-Pin CERDIP (derate 9.09mW/°C above +70°C)	727mW
All Input Pins	10mA	Operating Temperature Ranges:	
All Other Pins	50mA	MAX4_ _C_ _	0°C to +70°C
Short-Circuit Duration	Continuous	MAX4_ _E_ _	-40°C to +85°C
Continuous Power Dissipation (T _A = +70°C)		MAX4_ _M_ _	-55°C to +125°C
8-Pin Plastic DIP (derate 9.09mW/°C above +70°C)	727mW	Storage Temperature Range	-65°C to +160°C
8-Pin SO (derate 5.88mW/°C above +70°C)	471mW	Lead Temperature (soldering, 10sec)	+300°C
8-Pin CERDIP (derate 8.00mW/°C above +70°C)	640mW		

Note 1: Absolute Maximum Ratings do not apply to devices supplied in die or wafer form.

Stresses beyond those listed under "Absolute Maximum Ratings" may cause permanent damage to the device. These are stress ratings only, and functional operation of the device at these or any other conditions beyond those indicated in the operational sections of the specifications is not implied. Exposure to absolute maximum rating conditions for extended periods may affect device reliability.

ELECTRICAL CHARACTERISTICS

(V+ = 2.5V, V- = -2.5V, T_A = +25°C, unless otherwise noted.)

PARAMETER	SYMBOL	CONDITIONS		MIN	TYP	MAX	UNITS
Input Offset Voltage	V _{OS}	MAX406A, MAX409A			0.25	0.5	mV
		MAX406B, MAX409B			0.75	2.0	
		MAX407, MAX417			1.0	3.0	
		MAX418, MAX419			1.0	4.0	
Input Bias Current	I _B	V _{CM} = 0V (Note 2)			<0.1	10.0	pA
Large-Signal Voltage Gain	A _{VOL}	R _L = 1MΩ, V _{OUT} = ±2V	MAX406A, MAX409A	200	1000		V/mV
			MAX406B, MAX407, MAX409B, MAX41_	100	1000		
		R _L = 1MΩ, V _{OUT} = ±4V, V+ = 5V, V- = -5V		10	23		
Gain Bandwidth	GBW	MAX406A/B	Compensated mode	4	8		kHz
			Decompensated mode (A _v = 2V/V)	20	40		
		MAX407, MAX418			4	8	
		MAX409A/B, MAX417, MAX419, A _{vCL} ≥ 10V/V		80	150		
Input Common-Mode Range	CMR	MAX406A/B, MAX409A/B		V-		V+ -1.1	V
		MAX407, MAX41_		V-		V+ -1.2	
Output Voltage Swing	V _O	R _L = 1MΩ		±2.47	±2.49		V
Common-Mode Rejection Ratio	CMRR	(Note 3)	MAX406A, MAX409A	70	80		dB
			MAX406B, MAX407, MAX409B, MAX41_	60	80		
Power-Supply Rejection Ratio	PSRR	V _{IN} = 0V, V+ = 2.5V to 7.5V	MAX406A, MAX409A		50	100	μV/V
			MAX406B, MAX409B		150	300	
			MAX407, MAX41_		200	600	

1.2 μ A Max, Single/Dual/Quad, Single-Supply Op Amps

ELECTRICAL CHARACTERISTICS (continued)

(V+ = 2.5V, V- = -2.5V, TA = +25°C, unless otherwise noted.)

PARAMETER	SYMBOL	CONDITIONS	MIN	TYP	MAX	UNITS	
Slew Rate	SR	MAX406A/B	Compensated mode		3	5	V/ms
			Decompensated mode (Av = 2V/V)		12	20	
		MAX407, MAX418		3	5		
		MAX409A/B, MAX417, MAX419 AvCL \geq 10V/V		40	80		
Supply Current Per Amplifier	ISY			1.0	1.2	μ A	
Output Sink Current	IOSINK	VOUT = 0V	100	200		μ A	
Output Source Current	IOSOURCE	VOUT = 0V	300	600		μ A	
Supply Voltage (V+ to V-)	VS		2.5		10.0	V	
Input Noise Voltage	en	f _o = 1kHz		150		nV/ \sqrt Hz	
		f _o = 0.1Hz to 10Hz		6		μ V _{p-p}	

ELECTRICAL CHARACTERISTICS

(V+ = 2.5V, V- = -2.5V, TA = 0°C to +70°C, unless otherwise noted.)

PARAMETER	SYMBOL	CONDITIONS	MIN	TYP	MAX	UNITS
Input Offset Voltage	VOS	MAX406A, MAX409A			0.95	mV
		MAX406B, MAX409B			3.00	
		MAX407			4.00	
		MAX41_			5.00	
Offset-Voltage Tempco	TCVOS	MAX406A, MAX409A, 100% drift tested		2	10	μ V/°C
Input Bias Current	IB	VCM = 0V			20	pA
Large-Signal Voltage Gain	AVOL	RL = 1M Ω , VOUT = \pm 2V	MAX406A, MAX409A	100		V/mV
			MAX406B	50		
		RL = 1M Ω , (VOUT = \pm 4V, V+ = 5V, V- = -5V)		10		
Output Voltage Swing	VO	RL = 1M Ω	\pm 2.45			V
Common-Mode Rejection Ratio	CMRR	(Note 3)	MAX406A, MAX409A	66		dB
			MAX406B, MAX407 MAX409B, MAX41_	60		
Power-Supply Rejection Ratio	PSRR	VIN = 0V, V+ = 2.5V to 7.5V	MAX406A, MAX409A		150	μ V/V
			MAX406B, MAX409B		450	
			MAX407, MAX41_		800	

MAX406/MAX407/MAX409/MAX417-MAX419

1.2μA Max, Single/Dual/Quad, Single-Supply Op Amps

ELECTRICAL CHARACTERISTICS (continued)

(V+ = 2.5V, V- = -2.5V, TA = 0°C to +70°C, unless otherwise noted.)

PARAMETER	SYMBOL	CONDITIONS	MIN	TYP	MAX	UNITS
Supply Current Per Amplifier	ISY				1.6	μA
Output Sink Current	IOSINK	VOUT = 0V	50			μA
Output Source Current	IOSOURCE	VOUT = 0V	250			μA

ELECTRICAL CHARACTERISTICS

(V+ = 2.5V, V- = -2.5V, TA = -40°C to +85°C, unless otherwise noted.)

PARAMETER	SYMBOL	CONDITIONS	MIN	TYP	MAX	UNITS
Input Offset Voltage	VOS	MAX406A, MAX409A			1.10	mV
		MAX406B, MAX409B			3.00	
		MAX407, MAX417			4.00	
		MAX418, MAX419			5.00	
Offset-Voltage Tempco	TCVOS	MAX406A, MAX409A, 100% drift tested			10	μV/°C
Input Bias Current	IB	VCM = 0V			50	pA
Large-Signal Voltage Gain	AVOL	RL = 1MΩ, VOUT = ±2V				V/mV
		MAX406A, MAX409A	50			
		MAX406B, MAX407, MAX409B, MAX41_	25			
		RL = 1MΩ, VOUT = ±4V, V+ = 5V, V- = -5V	10			
Output Voltage Swing	VO	RL = 1MΩ	±2.45			V
Common-Mode Rejection Ratio	CMRR	(Note 3)	MAX406A, MAX409A	66		dB
			MAX406B, MAX407, MAX409B, MAX41_	60		
Power-Supply Rejection Ratio	PSRR	VIN = 0V, V+ = 2.5V to 7.5V	MAX406A, MAX409A		150	μV/V
			MAX406B, MAX409B		450	
			MAX407, MAX41_		800	
Supply Current Per Amplifier	ISY				1.7	μA
Output Sink Current	IOSINK	VOUT = 0V	40			μA
Output Source Current	IOSOURCE	VOUT = 0V	250			μA

1.2μA Max, Single/Dual/Quad, Single-Supply Op Amps

ELECTRICAL CHARACTERISTICS

(V₊ = 2.5V, V₋ = -2.5V, T_A = -55°C to +125°C, unless otherwise noted.)

PARAMETER	SYMBOL	CONDITIONS		MIN	TYP	MAX	UNITS
Input Offset Voltage	V _{OS}	MAX406A, MAX409A				1.5	mV
		MAX406B, MAX409B				4.0	
		MAX407, MAX417				5.0	
		MAX418, MAX419				6.0	
Offset-Voltage Tempco	TC _{VOS}	MAX406A, MAX409A, 100% drift tested				10	μV/°C
Input Bias Current	I _B	V _{CM} = 0V				1.0	nA
Large-Signal Voltage Gain	A _{VOL}	R _L = 1MΩ, V _{OUT} = ±2V	MAX406A, MAX409A	10			V/mV
			MAX406B, MAX407, MAX409B, MAX41_	5			
		R _L = 1MΩ, V _{OUT} = ±4V, V ₊ = 5V, V ₋ = -5V		10			
Output Voltage Swing	V _O	R _L = 1MΩ		±2.45			V
Common-Mode Rejection Ratio	CMRR	(Note 3)	MAX406A, MAX409A	66			dB
			MAX406B, MAX407, MAX409B, MAX41_	60			
Power-Supply Rejection Ratio	PSRR	V _{IN} = 0V, V ₊ = 2.5V to 7.5V	MAX406A, MAX409A			150	μV/V
			MAX406B, MAX409B			450	
			MAX407, MAX41_			800	
Supply Current Per Amplifier	I _{SY}					2.0	μA
Output Sink Current	I _{OSINK}	V _{OUT} = 0V		20			μA
Output Source Current	I _{OSOURCE}	V _{OUT} = 0V		200			μA

Note 2: Production-automated test equipment cannot resolve input bias currents below 1pA. Lab equipment has shown the MAX40_ , MAX41_ typical input bias currents below 0.1pA.

Note 3: MAX406A/MAX409A: V_{CM} = V₋ to (V₊ - 1.1V). MAX407, MAX41_ V_{CM} = V₋ to (V₊ - 1.2V).

MAX406/MAX407/MAX409/MAX417-MAX419

1.2μA Max, Single/Dual/Quad, Single-Supply Op Amps

Typical Operating Characteristics

(V+ 2.5V, V- = -2.5V, TA = +25°C, unless otherwise noted.)

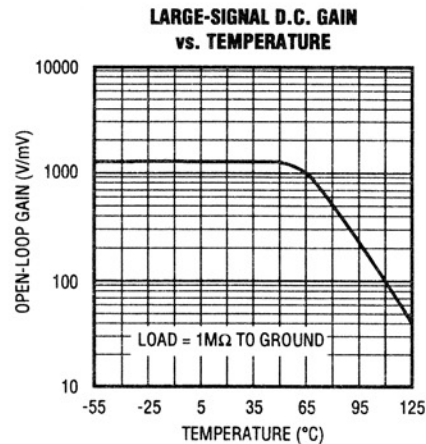
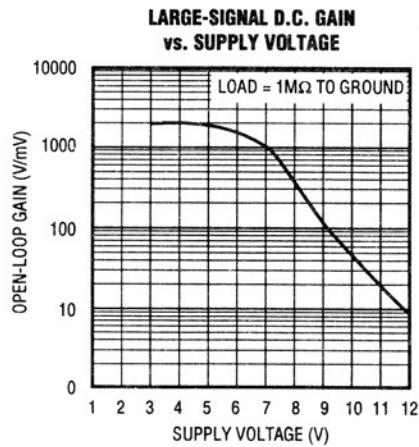
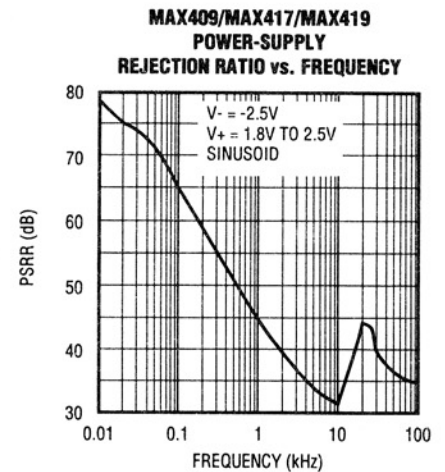
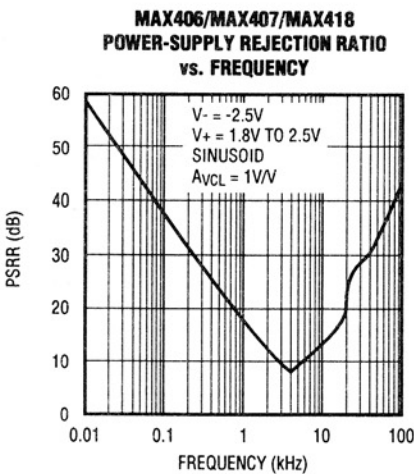
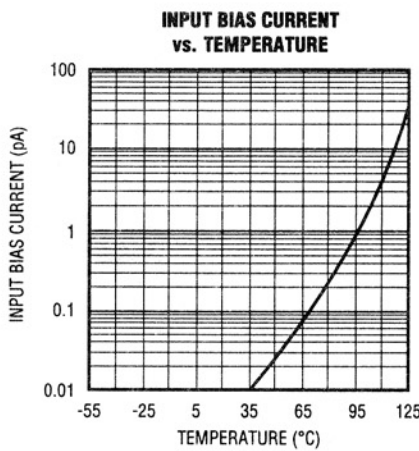
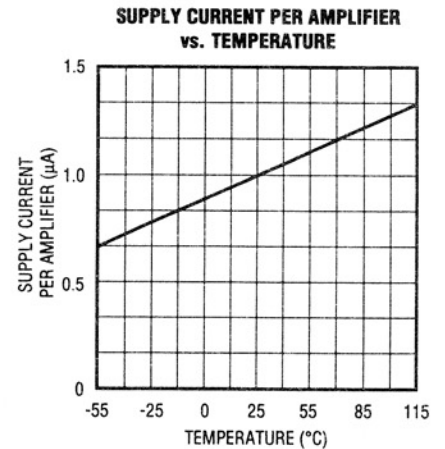
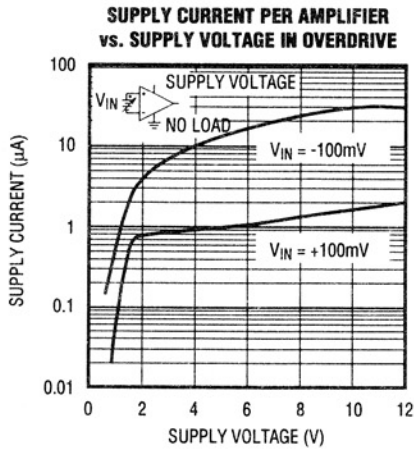
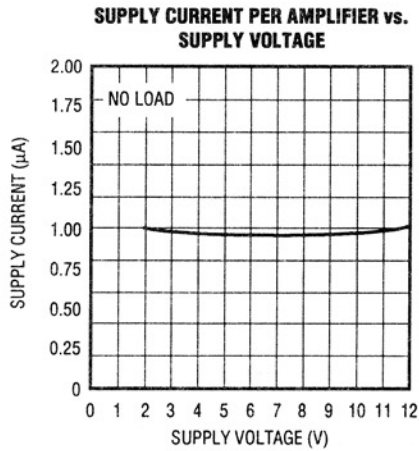

1.2 μ A Max, Single/Dual/Quad, Single-Supply Op Amps

Typical Operating Characteristics (continued)

($V_+ = 2.5V$, $V_- = -2.5V$, $T_A = +25^\circ C$, unless otherwise noted).

MAX406/MAX407/MAX409/MAX417-MAX419

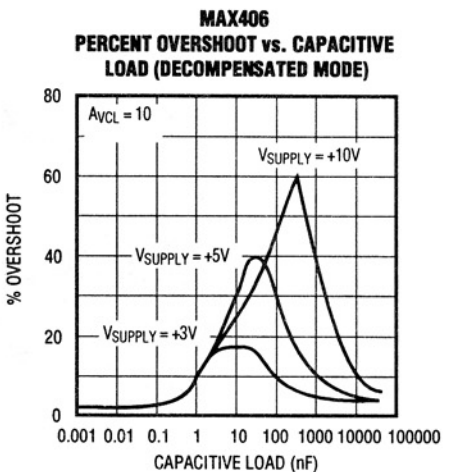
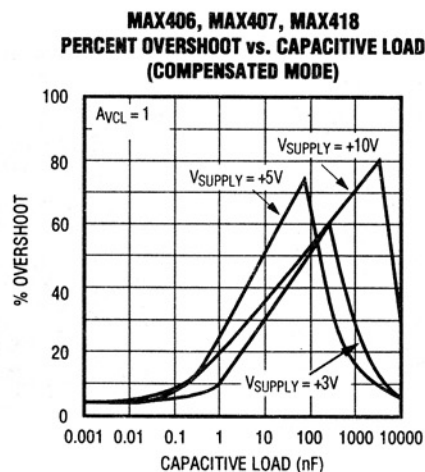
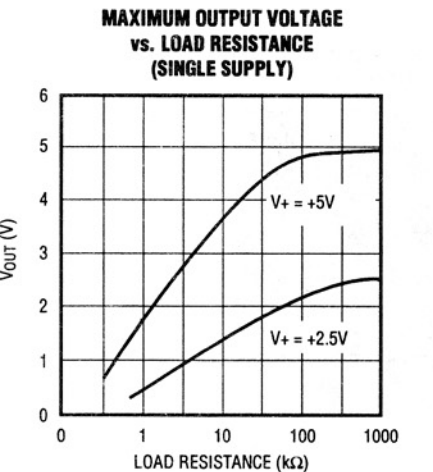
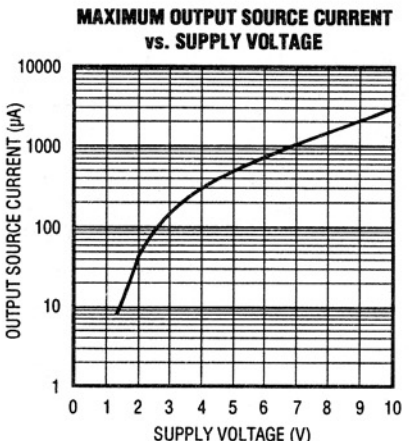
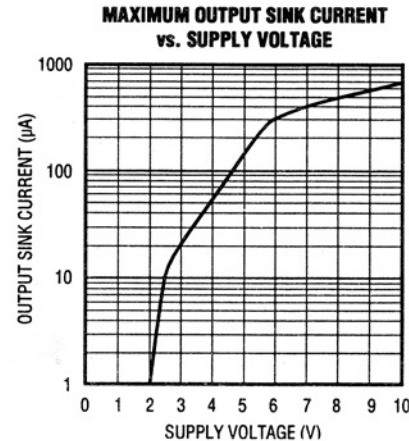
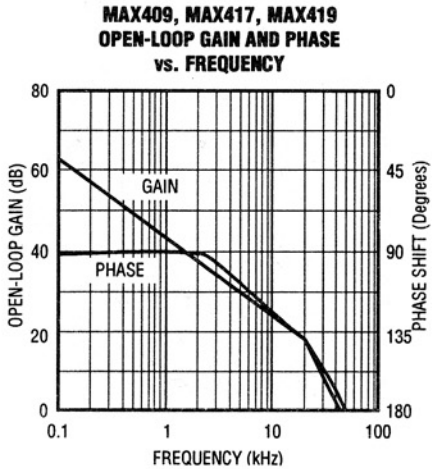
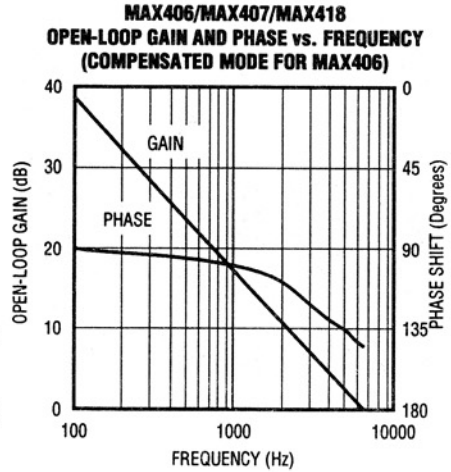
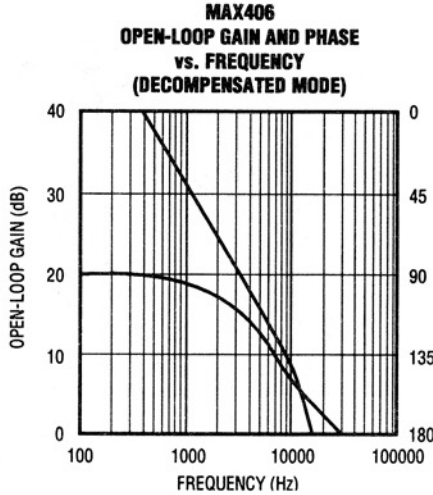
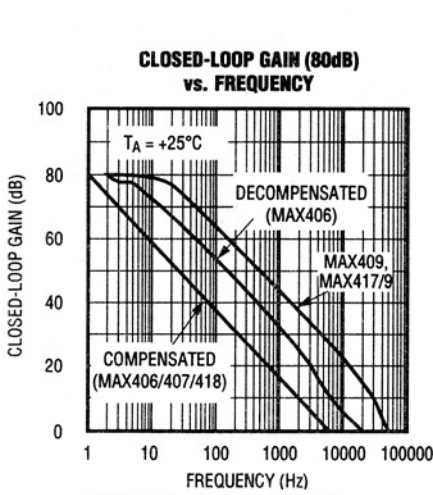

1.2 μ A Max, Single/Dual/Quad, Single-Supply Op Amps

Typical Operating Characteristics

($T_A = +25^\circ\text{C}$, unless otherwise noted).

**MAX406/MAX407/MAX418
LARGE-SIGNAL TRANSIENT RESPONSE**

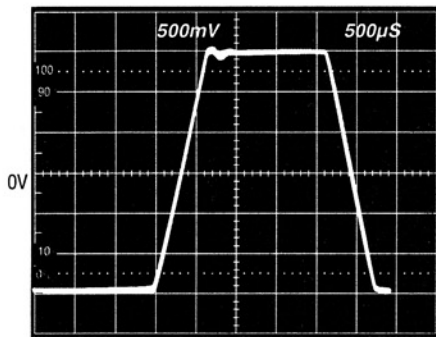

NONINVERTING, $A_{VCL} = 1V/V$,
 $V_{SUPPLY} = \pm 2.5V$, $LOAD = 1M\Omega \parallel 250pF$

**MAX406/MAX407/MAX418
LARGE-SIGNAL TRANSIENT RESPONSE**

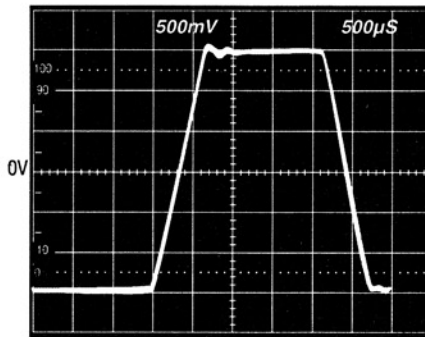

NONINVERTING, $A_{VCL} = 1V/V$,
 $V_{SUPPLY} = \pm 2.5V$, $LOAD = 1M\Omega \parallel 1000pF$

**MAX406 (DECOMPENSATED MODE)
LARGE-SIGNAL TRANSIENT RESPONSE**

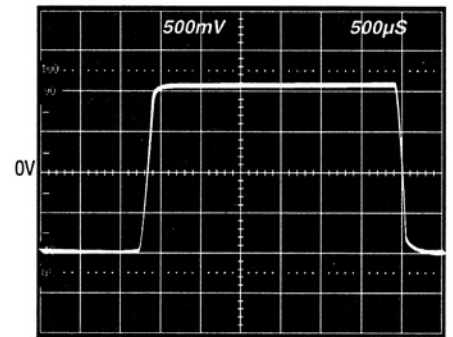

$V_{SUPPLY} = \pm 2.5V$, $A_{VCL} = 2V/V$,
 $LOAD = 1M\Omega \parallel 15pF$

**MAX406/MAX407/MAX418
SMALL-SIGNAL TRANSIENT RESPONSE**

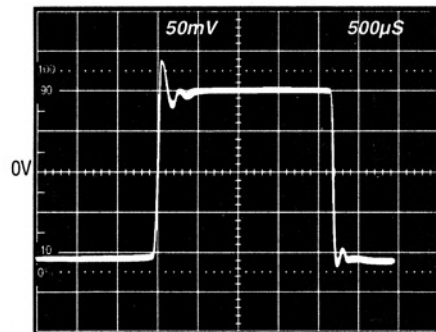

NONINVERTING, $A_{VCL} = 1V/V$,
 $V_{SUPPLY} = \pm 2.5V$, $LOAD = 1M\Omega \parallel 250pF$

**MAX406/MAX407/MAX418
SMALL-SIGNAL TRANSIENT RESPONSE**

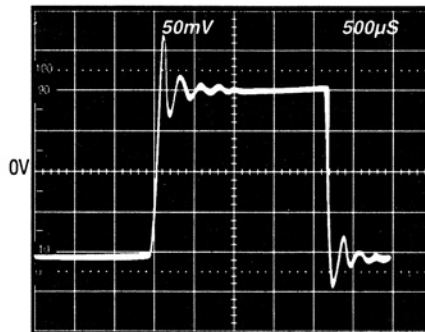

NONINVERTING, $A_{VCL} = 1V/V$,
 $V_{SUPPLY} = \pm 2.5V$, $LOAD = 1M\Omega \parallel 1000pF$

**MAX406 (DECOMPENSATED MODE)
SMALL-SIGNAL TRANSIENT RESPONSE**

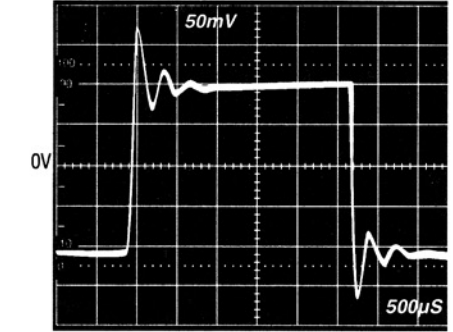

$A_{VCL} = 10V/V$,
 $V_{SUPPLY} = \pm 2.5V$, $LOAD = 1M\Omega \parallel 1000pF$

**MAX409/MAX417/MAX419
LARGE-SIGNAL TRANSIENT RESPONSE**

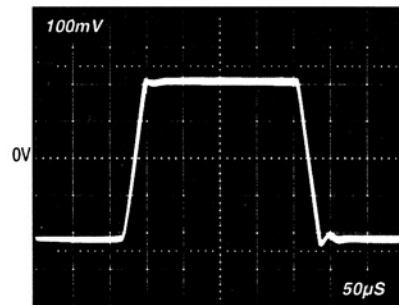

$A_V = 10V/V$, $V_{SUPPLY} = \pm 2.5V$, $LOAD = 1M\Omega \parallel 10pF$

**MAX409/MAX417/MAX419
SMALL-SIGNAL TRANSIENT RESPONSE**

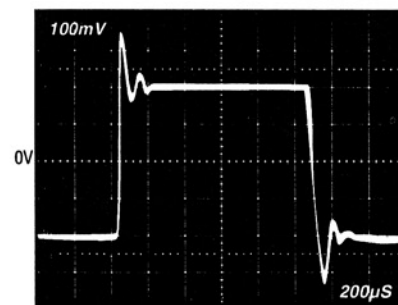

$A_V = 10V/V$, $V_{SUPPLY} = \pm 2.5V$, $LOAD = 1M\Omega \parallel 110pF$

MAX406/MAX407/MAX409/MAX417-MAX419

1.2 μ A Max, Single/Dual/Quad, Single-Supply Op Amps

Typical Operating Characteristics (continued)

MAX409/MAX417/MAX419
LARGE-SIGNAL TRANSIENT RESPONSE



$A_V = 10V/V$, $V_{SUPPLY} = \pm 2.5V$, $LOAD = 1M\Omega \parallel 10pF$

MAX409/MAX417/MAX419
LARGE-SIGNAL TRANSIENT RESPONSE

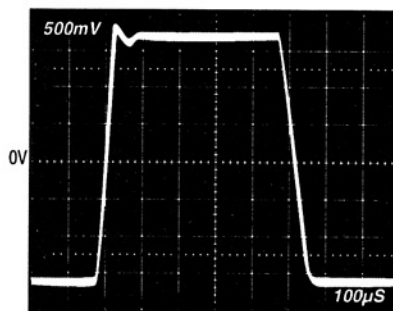

$A_V = 10V/V$, $V_{SUPPLY} = \pm 2.5V$, $LOAD = 1M\Omega \parallel 110pF$

Pin Description

MAX406 PIN	MAX407 MAX417 PIN	MAX409 PIN	MAX418 MAX419 PIN	NAME	FUNCTION
1		1		NULL	Nulling. Connect to one end of 100k potentiometer for offset voltage trimming. See Figure 1.
	1		1	OUTA	Amplifier Output A
2		2		IN-	Inverting Input
	2		2	INA-	Inverting Input A
3		3		IN+	Noninverting Input
	3		3	INA+	Noninverting Input A
4	4	4	11	V-	Negative Power-Supply Pin. Connect to (-) terminal of power supply or ground.
5		5		NULL	Nulling. Connect to one end of 100k potentiometer for offset voltage trimming. Connect wiper to V+. See Figure 1.
	5		5	INB+	Noninverting Input B
6		6		OUT	Amplifier Output
	6		6	INB-	Inverting Input B
7	8	7	4	V+	Positive Supply Pin. Connect to (+) terminal of power supply.
	7		7	OUTB	Amplifier Output B
8				BW	Bandwidth Selection Pin. Leave floating or connect to V- for unity-gain stability (compensated mode) or connect to V+ (decompensated mode).
		8		I.C.	Internal Connection. Make no connection to this pin.
			8	OUTC	Amplifier Output C
			9	INC-	Inverting Input C
			10	INC+	Noninverting Input C
			12	IND+	Noninverting Input D
			13	IND-	Inverting Input D
			14	OUTD	Amplifier Output D

1.2μA Max, Single/Dual/Quad, Single-Supply Op Amps

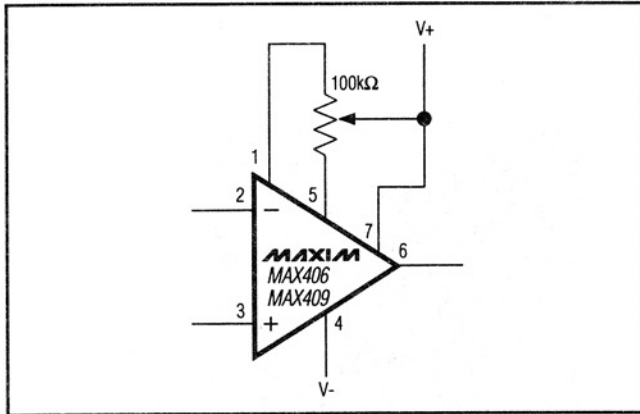

Figure 1. Offset-Voltage Adjustment

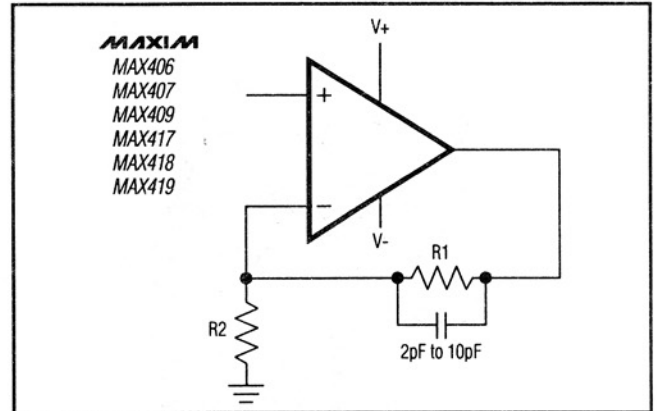

Figure 2. Compensation for Feedback Node Capacitance

Applications Information

Trimming Voltage Offset

The MAX406/MAX409's typical input offset voltage is between 0.25mV and 0.75mV, depending on the grade. If the application requires additional offset adjustment, connect a 100kΩ trim pot between pins 1, 5, and 7 for the MAX406/MAX409 (Figure 1). The dual and quad amplifiers' offset voltages are not adjustable.

Input Overdrive vs. Supply Current

The supply current of the MAX406/MAX407/MAX409/MAX417-MAX419 remains relatively constant over the supply range if the amplifier output is not overdriven to the negative supply rail. For example, when connecting the amplifier as a comparator and applying a -100mV input overdrive, supply current rises above the 1μA per amplifier typical value and varies with supply voltage. (see Supply Current vs. Supply Voltage in Overdrive, *Typical Operating Characteristics*).

Total Supply-Voltage Considerations

Although the MAX406/MAX407/MAX409/MAX417-MAX419 can operate with supply voltages between 2.5V and 10V, best performance is achieved with supply voltages below 7V. The Open-Loop Gain vs. Supply Voltage graph in the *Typical Operating Characteristics* shows how open-loop gain is reduced at voltages that exceed 7V.

Bandwidth

The MAX407/MAX418 are internally compensated for stable unity-gain operation, with an 8kHz typical gain bandwidth. The MAX409/MAX417/MAX419 have a 150kHz typical gain-bandwidth product and are stable with a gain of 10V/V or greater.

The MAX406 operates in one of two modes. Floating BW or connecting BW to V- internally compensates the amplifier for stable unity-gain operation. Connecting BW to V+ reduces the compensation and allows the amplifier to be used at higher speeds. When operating in decompensated mode, the MAX406 is stable for closed loop gains $\geq 2V/V$, with a 40kHz typical gain bandwidth and a 20V/ms typical slew rate.

Stability

Unlike other industry-standard micropower CMOS op amps, the MAX406/MAX407/MAX409/MAX417-MAX419 maintain stability in their minimum gain configuration while driving heavy capacitive loads, as demonstrated in the Percent Overshoot vs. Capacitive Load graph in the *Typical Operating Characteristics*.

Although this product family is primarily designed for low-frequency applications, good layout is extremely important. This is because low power requirements demand high-impedance circuits. A 10MΩ impedance and a 1pF capacitance will provide a breakpoint at approximately 16kHz, which is near the amplifier's bandwidth. The layout should minimize stray capacitance at the amplifier's inputs. However, some stray capacitance may be unavoidable, and it may be necessary to add a 2pF to 10pF capacitor across the feedback resistor as shown in Figure 2. Select the smallest capacitor value that insures stability.

Typical Application Circuits

Buffered pH Probe Allows Low-Cost Cable

The MAX406 has less than 20pA input leakage current over the commercial temperature range, and is typically less than 100fA at +25°C. These characteristics are ideal for buffering pH probes and a variety of other high output impedance chemical sensors. The circuit in

1.2 μ A Max, Single/Dual/Quad, Single-Supply Op Amps



Figure 3. Buffered pH Probe Allows Low-Cost Cable

Figure 3 eliminates expensive low-leakage cables that often connect pH probes to meters. A MAX406 and a lithium battery are included in the probe housing. A conventional low-cost coaxial cable carries the buffered pH signal to the MAX131 A/D converter. In most cases, the probe assembly's battery life exceeds the functional life of the probe itself.

Micropower, 4-Channel Simultaneous Sample-and-Hold

Switch leakage and buffer input bias current in sample and hold circuits limit performance by discharging the signal voltage on the hold capacitor (an effect called "droop"). The 2pA typical room temperature leakage current for the MAX327 and 100fA typical input bias current for the MAX407 translates to a typical droop rate of 200 μ V/sec for Figure 4's circuit. Another advantage is low power consumption. The MAX327 guarantees no more than 250 μ A supply current with \pm 15V supplies, but most of this is drawn by internal logic-level translators. By using rail-to-rail logic (CD4000, 74C00, or 74HC00 families) to drive IN1-IN3, the level

translators are turned off and the supply current falls well below 1 μ A when the switches are off. This technique turns any Maxim switch or multiplexer into an ultra low-power device. Figure 4's circuit typically draws 6 μ A with 0V to 9V logic input levels.

Remotely Powered Sensor Amp

Figure 5 shows a simple 2-wire current transmitter that uses no power at the transmitting end except from the transmitted signal itself. At the transmitter, a 0V to 1V input drives both a MAX406 and an NPN transistor connected as a voltage-controlled current sink. The 0mA to 2mA output is sent through a twisted pair to the receiver and develops a voltage across the receiver sense resistor R2. The resulting sense voltage is buffered by another MAX406, producing a 0V to 1V ground-referenced output signal. R1 and R2 should be well matched. The MAX406's supply current is added to the 0mA to 2mA signal, resulting in a 500 μ V offset at the output. This offset, in addition to the MAX406's input offset, varies with temperature.

MAX406/MAX407/MAX409/MAX417-MAX419

1.2μA Max, Single/Dual/Quad, Single-Supply Op Amps



Figure 4. Micropower, 4-Channel, Simultaneous Sample-and-Hold



Figure 5. Remotely Powered Sensor Amp

1.2 μ A Max, Single/Dual/Quad, Single-Supply Op Amps

Negative Reference Circuit Draws Less Than 11 μ A

By biasing a low-power, low-dropout reference (MAX872) so it sits in the feedback path of a MAX406, a precise -2.50V reference is produced that requires no external components, as shown in Figure 6. This is superior to a standard inverting configuration, which requires two resistors that can add errors.

Other advantages of this circuit are:

1. Maximum current drain is 11 μ A.
2. The output load is driven by the op amp so there is no degradation of voltage due to load regulation.
3. No compensation is needed for load capacitance.

The supplies do not have to be carefully regulated. The positive supply can be as low as 1.1V and the negative supply can be as little as 2.7V.

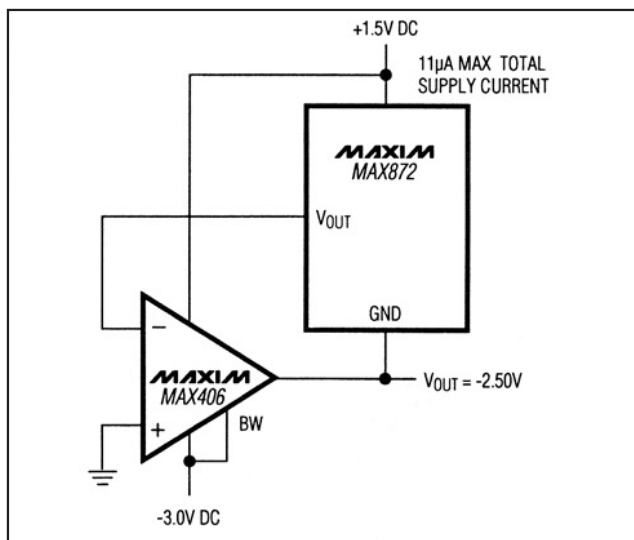

Figure 6. Micropower, Low-Dropout Negative Reference

Ordering Information

PART	TEMP RANGE	PIN-PACKAGE
MAX406 ACPA	0°C to +70°C	8 Plastic DIP
MAX406BCPA	0°C to +70°C	8 Plastic DIP
MAX406ACSA	0°C to +70°C	8 SO
MAX406BCSA	0°C to +70°C	8 SO
MAX406C/D	0°C to +70°C	Dice*
MAX406AEPA	-40°C to +85°C	8 Plastic DIP
MAX406BEPA	-40°C to +85°C	8 Plastic DIP
MAX406AESA	-40°C to +85°C	8 SO
MAX406BESA	-40°C to +85°C	8 SO
MAX406AMJA	-55°C to +125°C	8 CERDIP
MAX406BMJA	-55°C to +125°C	8 CERDIP
MAX407 CPA	0°C to +70°C	8 Plastic DIP
MAX407CSA	0°C to +70°C	8 SO
MAX407C/D	0°C to +70°C	Dice*
MAX407EPA	-40°C to +85°C	8 Plastic DIP
MAX407ESA	-40°C to +85°C	8 SO
MAX407MJA	-55°C to +125°C	8 CERDIP
MAX409 ACPA	0°C to +70°C	8 Plastic DIP
MAX409BCPA	0°C to +70°C	8 Plastic DIP
MAX409ACSA	0°C to +70°C	8 SO
MAX409BCSA	0°C to +70°C	8 SO
MAX409BC/D	0°C to +70°C	Dice*
MAX409AEPA	-40°C to +85°C	8 Plastic DIP
MAX409BEPA	-40°C to +85°C	8 Plastic DIP

PART	TEMP RANGE	PIN-PACKAGE
MAX409AESA	-40°C to +85°C	8 SO
MAX409BESA	-40°C to +85°C	8 SO
MAX409AMJA	-55°C to +125°C	8 CERDIP
MAX409BMJA	-55°C to +125°C	8 CERDIP
MAX417 CPA	0°C to +70°C	8 Plastic DIP
MAX417CSA	0°C to +70°C	8 SO
MAX417C/D	0°C to +70°C	Dice*
MAX417EPA	-40°C to +85°C	8 Plastic DIP
MAX417ESA	-40°C to +85°C	8 SO
MAX417MJA	-55°C to +125°C	8 CERDIP
MAX418 CPD	0°C to +70°C	14 Plastic DIP
MAX418CSD	0°C to +70°C	14 SO
MAX418EPD	-40°C to +85°C	14 Plastic DIP
MAX418ESD	-40°C to +85°C	14 SO
MAX418MJD	-55°C to +125°C	14 CERDIP
MAX418MSA/PR	-55°C to +125°C	8 SO**
MAX418MSA/PR-T	-55°C to +125°C	8 SO**
MAX419 CPD	0°C to +70°C	14 Plastic DIP
MAX419CSD	0°C to +70°C	14 SO
MAX419EPD	-40°C to +85°C	14 Plastic DIP
MAX419ESD	-40°C to +85°C	14 SO
MAX419MJD	-55°C to +125°C	14 CERDIP

*Dice are specified at +25°C, DC parameters only.

**Contact factory for availability.

MAX406/MAX407/MAX409/MAX417-MAX419

1.2μA Max, Single/Dual/Quad, Single-Supply Op Amps

Pin Configurations

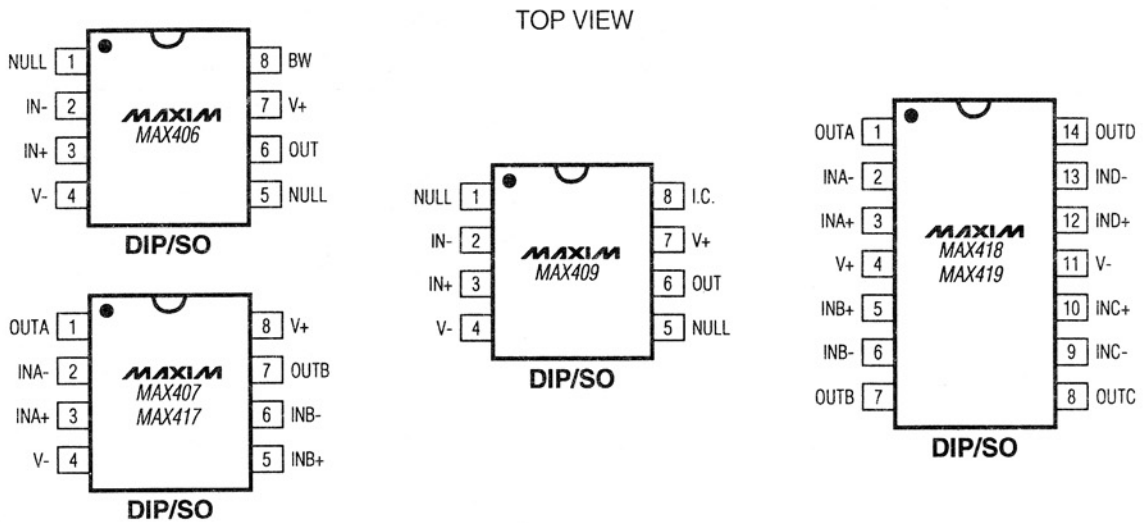

Chip Topographies

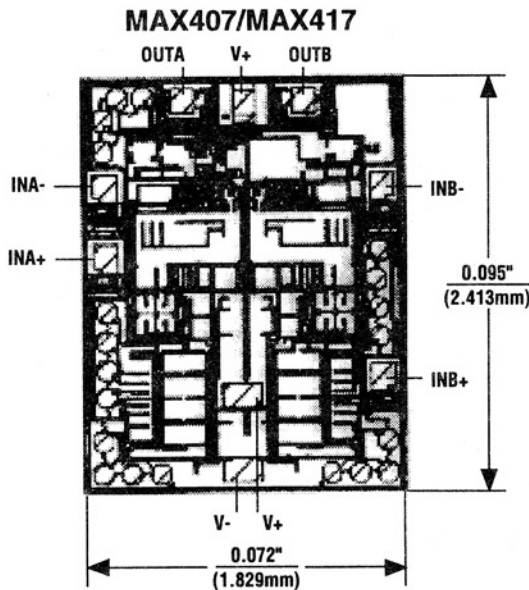

TRANSISTOR COUNT: 98;
SUBSTRATE CONNECTED TO V+.

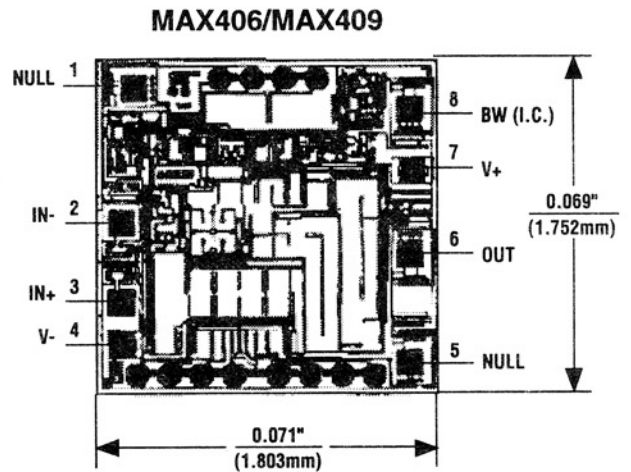

TRANSISTOR COUNT: 148;
SUBSTRATE CONNECTED TO V+.

1.2 μ A Max, Single/Dual/Quad, Single-Supply Op Amps

Package Information

For the latest package outline information and land patterns, go to www.maxim-ic.com/packages.

PACKAGE TYPE	PACKAGE CODE	DOCUMENT NO.
8 Plastic DIP	P8-1	21-0043
8 SO	S8-2	21-0041
8 CERDIP	J8-2	21-0045
14 Plastic DIP	P14-3	21-0043
14 SO	S14-1	21-0041
14 CERDIP	J14-3	21-0045

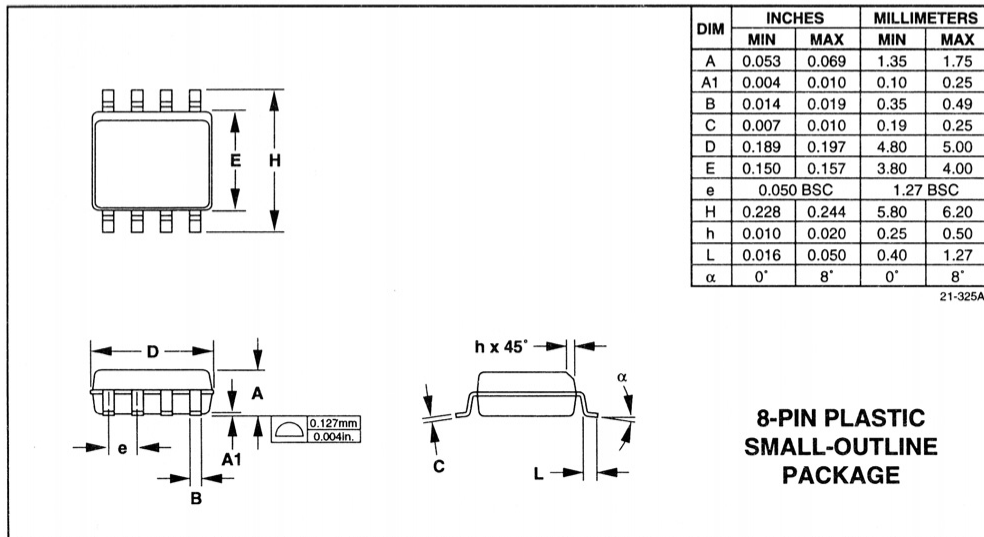
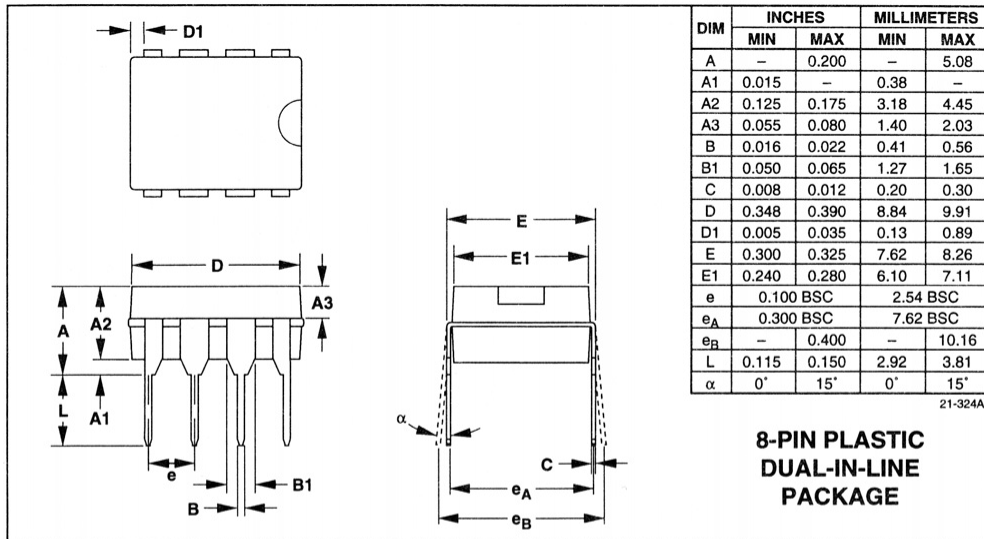

MAX406/MAX407/MAX409/MAX417-MAX419

1.2µA Max, Single/Dual/Quad, Single-Supply Op Amps

Package Information (continued)

For the latest package outline information and land patterns, go to www.maxim-ic.com/packages.

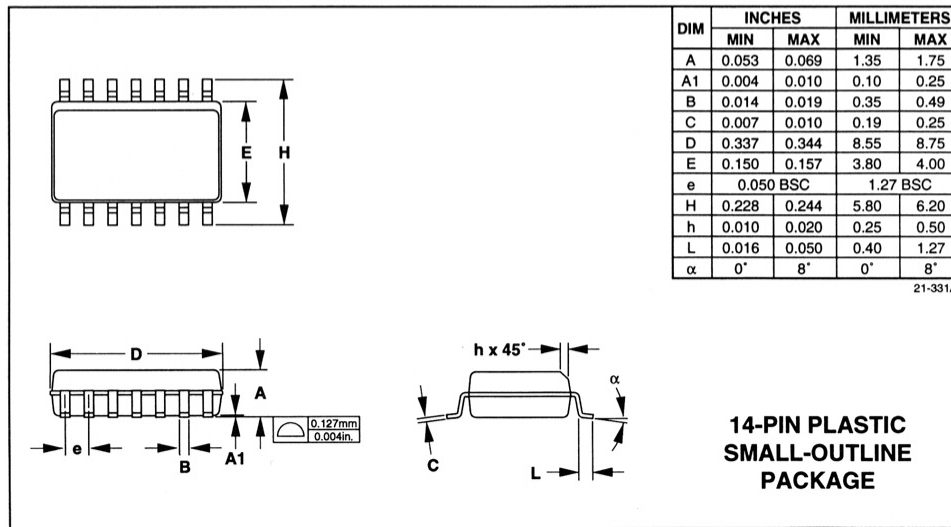
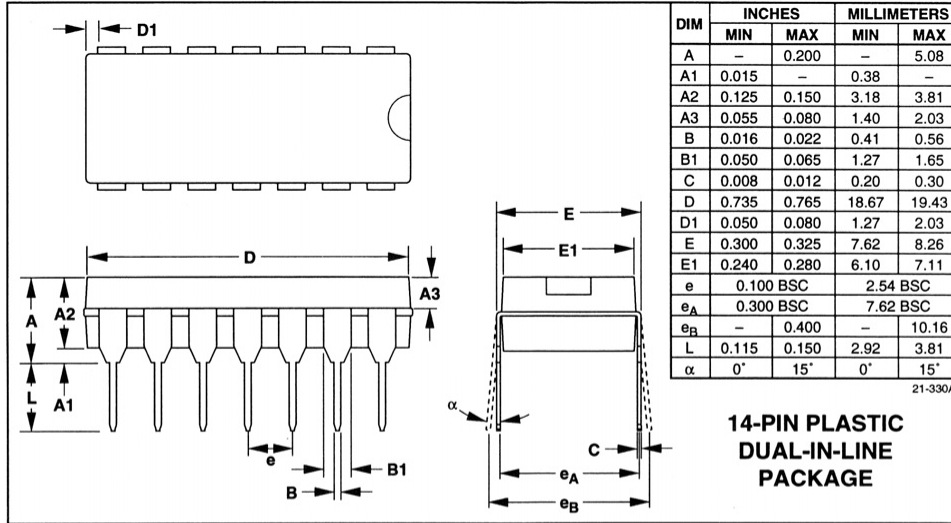

1.2 μ A Max, Single/Dual/Quad, Single-Supply Op Amps

Revision History

REVISION NUMBER	REVISION DATE	DESCRIPTION	PAGES CHANGED
3	10/08	Added rugged plastic part	13

MAX406/MAX407/MAX409/MAX417-MAX419

Maxim cannot assume responsibility for use of any circuitry other than circuitry entirely embodied in a Maxim product. No circuit patent licenses are implied. Maxim reserves the right to change the circuitry and specifications without notice at any time.

Maxim Integrated Products, 120 San Gabriel Drive, Sunnyvale, CA 94086 408-737-7600 _____ 17