



# 60mA, SOT23 Inverting Charge Pump with Shutdown

MAX1697

## General Description

The MAX1697 ultra-small, monolithic, CMOS charge-pump voltage inverter accepts an input voltage ranging from +1.25V to +5.5V. This device features an ultra-low 12Ω output resistance, permitting loads of up to 60mA with maximum efficiency. The MAX1697 is available with operating frequencies of 12kHz, 35kHz, 125kHz, or 250kHz, allowing optimization of supply current or external component size. Its small external components and micropower shutdown mode make this device ideal for both battery-powered and board-level voltage conversion applications.

Oscillator control circuitry and four power MOSFET switches are included on-chip. Applications include generating a negative supply from a +5V or +3.3V logic supply to power analog circuitry. All versions come in a 6-pin SOT23 package and deliver 60mA.

For applications with lower current requirements, the MAX1719/MAX1720/MAX1721 are pin-compatible SOT23 charge pumps that supply up to 25mA.

## Applications

- Negative Supply from +5V or +3.3V Logic Supplies
- Small LCD Panels
- GaAsFET Bias Supplies
- Handy-Terminals, PDAs
- Battery-Operated Equipment

## Typical Operating Circuit

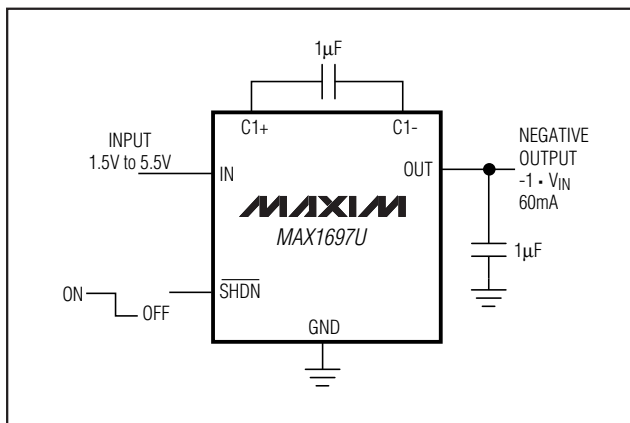

## Features

- ◆ 60mA Output Current
- ◆ Low 12Ω Output Resistance
- ◆ 150µA Supply Current (MAX1697R)
- ◆ Requires Only Two 1µF Capacitors (MAX1697U)
- ◆ Start-Up Current Limited
- ◆ +1.25V to +5.5V Input Voltage Range
- ◆ 0.1µA Logic-Controlled Shutdown
- ◆ Slew-Rate Limited to Reduce EMI
- ◆ 6-Pin SOT23 Package

## Ordering Information

| PART          | TEMP. RANGE    | PIN-PACKAGE |
|---------------|----------------|-------------|
| MAX1697_EUT-T | -40°C to +85°C | 6 SOT23-6   |

**Note:** The MAX1697 is available with four different operating frequencies. Choose the desired frequency from the table below and insert the suffix in the blank above to complete the part number.

| PART NO. SUFFIX | FREQUENCY (kHz) | TOP MARK |
|-----------------|-----------------|----------|
| R               | 12              | AABV     |
| S               | 35              | AABW     |
| T               | 125             | AABX     |
| U               | 250             | AABY     |

## Pin Configuration

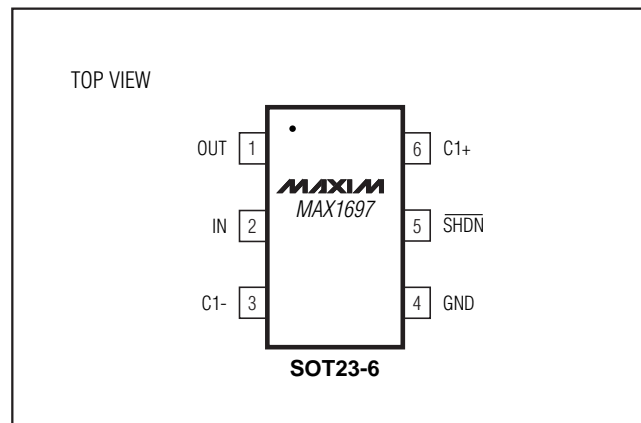

# 60mA, SOT23 Inverting Charge Pump with Shutdown

## ABSOLUTE MAXIMUM RATINGS

|                                      |   |
|--------------------------------------|---|
| IN to GND                            | -0.3V to +6V                                |
| C1+, $\overline{\text{SHDN}}$ to GND | -0.3V to ( $V_{\text{IN}} + 0.3\text{V}$ )  |
| C1- to GND                           | ( $V_{\text{OUT}} - 0.3\text{V}$ ) to +0.3V |
| OUT to GND                           | +0.3V to -6V                                |
| OUT Output Current                   | 90mA  |
| OUT Short-Circuit to GND             | Indefinite                                  |

|  |  |   |
|--|--|---|
| Continuous Power Dissipation ( $T_A = +70^\circ\text{C}$ ) | 6-Pin SOT23 (derate 14mW/ $^\circ\text{C}$ above $+70^\circ\text{C}$ ) | 1.1W  |
| Operating Temperature Range                                |  | $-40^\circ\text{C}$ to $+85^\circ\text{C}$  |
| Junction Temperature                                       |  | $+150^\circ\text{C}$                        |
| Storage Temperature Range                                  |  | $-65^\circ\text{C}$ to $+150^\circ\text{C}$ |
| Lead Temperature (soldering, 10sec)                        |  | $+300^\circ\text{C}$                        |

Stresses beyond those listed under "Absolute Maximum Ratings" may cause permanent damage to the device. These are stress ratings only, and functional operation of the device at these or any other conditions beyond those indicated in the operational sections of the specifications is not implied. Exposure to absolute maximum rating conditions for extended periods may affect device reliability.

## ELECTRICAL CHARACTERISTICS

(Circuit of Figure 1, capacitors from Table 2,  $V_{\text{IN}} = +5\text{V}$ ,  $\overline{\text{SHDN}} = \text{IN}$ ,  $T_A = 0^\circ\text{C}$  to  $+85^\circ\text{C}$ , unless otherwise noted. Typical values are at  $T_A = +25^\circ\text{C}$ .)

| PARAMETER                                 | CONDITIONS  |  | MIN                   | TYP   | MAX  | UNITS         |
|---|---|--|-----------------------|-------|------|---------------|
| Supply Voltage Range                      | MAX1697R/S, $R_L = 5\text{k}\Omega$   | $T_A = +25^\circ\text{C}$                      | 1.25                  |       | 5.5  | V             |
|   |   | $T_A = 0^\circ\text{C}$ to $+85^\circ\text{C}$ | 1.5                   |       | 5.5  |               |
|   | MAX1697T/U, $R_L = 5\text{k}\Omega$   | $T_A = +25^\circ\text{C}$                      | 1.4                   |       | 5.5  |               |
|   |   | $T_A = 0^\circ\text{C}$ to $+85^\circ\text{C}$ | 1.5                   |       | 5.5  |               |
| Quiescent Supply Current                  | $T_A = +25^\circ\text{C}$   | MAX1697R                                       |                       | 150   | 300  | $\mu\text{A}$ |
|   |   | MAX1697S                                       |                       | 350   | 650  |               |
|   |   | MAX1697T                                       |                       | 950   | 1700 |               |
|   |   | MAX1697U                                       |                       | 1800  | 3400 |               |
| Shutdown Supply Current                   | $\overline{\text{SHDN}} = \text{GND}$   | $T_A = +25^\circ\text{C}$                      |                       | 0.002 | 1    | $\mu\text{A}$ |
|   |   | $T_A = +85^\circ\text{C}$                      |                       | 0.03  |      |               |
| Short-Circuit Current                     | Output shorted to ground, $T_A = +25^\circ\text{C}$                                 |  |                       | 170   |      | mA            |
| Oscillator Frequency                      | $T_A = +25^\circ\text{C}$   | MAX1697R                                       | 7                     | 12    | 17   | kHz           |
|   |   | MAX1697S                                       | 20                    | 35    | 50   |               |
|   |   | MAX1697T                                       | 70                    | 125   | 180  |               |
|   |   | MAX1697U                                       | 140                   | 250   | 360  |               |
| Voltage Conversion Efficiency             | $I_{\text{OUT}} = 0$ , $T_A = +25^\circ\text{C}$                                    |  | 99                    | 99.9  |      | %             |
| Output Resistance (Note 1)                | $I_{\text{OUT}} = 60\text{mA}$  | $T_A = +25^\circ\text{C}$                      |                       | 12    | 25   | $\Omega$      |
|   |   | $T_A = 0^\circ\text{C}$ to $+85^\circ\text{C}$ |                       |       | 33   |               |
| OUT to GND Shutdown Resistance            | $\overline{\text{SHDN}} = \text{GND}$ , OUT is internally pulled to GND in shutdown |  |                       | 3     | 8    | $\Omega$      |
| $\overline{\text{SHDN}}$ Input Logic High | $2.5\text{V} \leq V_{\text{IN}} \leq 5.5\text{V}$                                   |  | 2.0                   |       |      | V             |
|   | $V_{\text{IN(MIN)}} \leq V_{\text{IN}} \leq 2.5\text{V}$                            |  | $V_{\text{IN}} - 0.2$ |       |      |               |
| $\overline{\text{SHDN}}$ Input Logic Low  | $2.5\text{V} \leq V_{\text{IN}} \leq 5.5\text{V}$                                   |  |                       |       | 0.6  | V             |
|   | $V_{\text{IN(MIN)}} \leq V_{\text{IN}} \leq 2.5\text{V}$                            |  |                       |       | 0.2  |               |
| $\overline{\text{SHDN}}$ Bias Current     | $\overline{\text{SHDN}} = \text{GND}$ or $\text{IN}$                                | $T_A = +25^\circ\text{C}$                      | -100                  | 0.05  | +100 | nA            |
|   |   | $T_A = +85^\circ\text{C}$                      |                       | 10    |      |               |
| Wake-Up Time from Shutdown                | $I_{\text{OUT}} = 15\text{mA}$  | MAX1697R                                       |                       | 1200  |      | $\mu\text{s}$ |
|   |   | MAX1697S                                       |                       | 600   |      |               |
|   |   | MAX1697T                                       |                       | 100   |      |               |
|   |   | MAX1697U                                       |                       | 70    |      |               |

# 60mA, SOT23 Inverting Charge Pump with Shutdown

MAX1697

## ELECTRICAL CHARACTERISTICS (continued)

(Circuit of Figure 1, capacitors from Table 2,  $V_{IN} = +5V$ ,  $\overline{SHDN} = IN$ ,  $T_A = 0^{\circ}C$  to  $+85^{\circ}C$ , unless otherwise noted.) Typical values are at  $T_A = +25^{\circ}C$ .)

| PARAMETER               | CONDITIONS             | MIN | TYP | MAX | UNITS       |
|-------------------------|------------------------|-----|-----|-----|-------------|
| <b>THERMAL SHUTDOWN</b> |                        |     |     |     |             |
| Trip Temperature        | Temperature increasing |     | 150 |     | $^{\circ}C$ |
| Hysteresis              |                        |     | 15  |     | $^{\circ}C$ |

## ELECTRICAL CHARACTERISTICS

(Circuit of Figure 1, capacitors from Table 2,  $V_{IN} = +5V$ ,  $\overline{SHDN} = IN$ ,  $T_A = -40^{\circ}C$  to  $+85^{\circ}C$ , unless otherwise noted.) (Note 2)

| PARAMETER                          | CONDITIONS  | MIN            | MAX  | UNITS    |   |
|------------------------------------|---|----------------|------|----------|---|
| Supply Voltage Range               | $R_L = 5k\Omega$  | MAX1697R/S     | 1.5  | 5.5      | V |
|                                    |   | MAX1697T/U     | 1.6  | 5.5      |   |
| Output Current                     | Continuous, long-term   |                | 60   | mARMS    |   |
| Quiescent Current                  | MAX1697R  |                | 350  | $\mu A$  |   |
|                                    | MAX1697S  |                | 750  |          |   |
|                                    | MAX1697T  |                | 1800 |          |   |
|                                    | MAX1697U  |                | 3600 |          |   |
| Oscillator Frequency               | MAX1697R  | 6              | 21   | kHz      |   |
|                                    | MAX1697S  | 16             | 60   |          |   |
|                                    | MAX1697T  | 60             | 200  |          |   |
|                                    | MAX1697U  | 120            | 400  |          |   |
| Output Resistance (Note 1)         | $I_{OUT} = 60mA$  |                | 33   | $\Omega$ |   |
| OUT to GND Shutdown Resistance     | $\overline{SHDN} = GND$ , OUT is internally pulled to GND in shutdown |                | 8    | $\Omega$ |   |
| $\overline{SHDN}$ Input Logic High | $2.5V \leq V_{IN} \leq 5.5V$  | 2.1            |      | V        |   |
|                                    | $V_{IN(MIN)} \leq V_{IN} \leq 2.5V$                                   | $V_{IN} - 0.2$ |      |          |   |
| $\overline{SHDN}$ Input Logic Low  | $2.5V \leq V_{IN} \leq 5.5V$  |                | 0.6  | V        |   |
|                                    | $V_{IN(MIN)} \leq V_{IN} \leq 2.5V$                                   |                | 0.2  |          |   |

**Note 1:** Output resistance is guaranteed with capacitor ESR of  $0.3\Omega$  or less.

**Note 2:** All specifications from  $-40^{\circ}C$  to  $+85^{\circ}C$  are guaranteed by design, not production tested.

# 60mA, SOT23 Inverting Charge Pump with Shutdown

## Typical Operating Characteristics

(Circuit of Figure 1, capacitors from Table 2,  $V_{IN} = +5V$ ,  $SHDN = IN$ ,  $T_A = +25^\circ C$ , unless otherwise noted.)

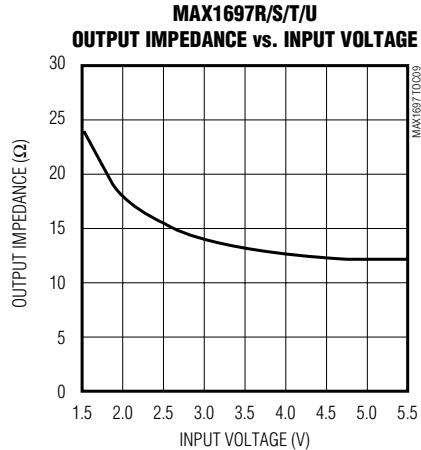
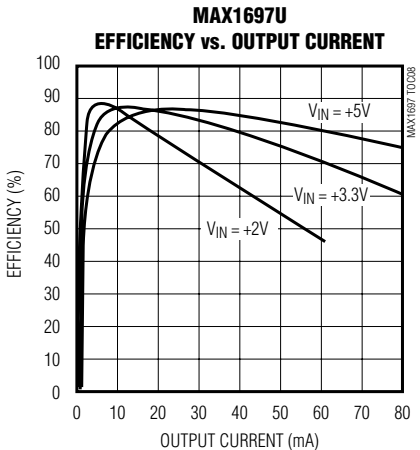
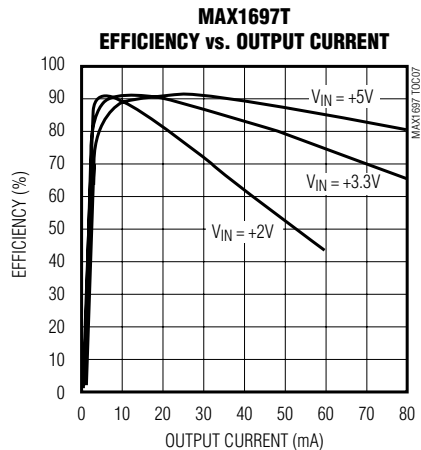
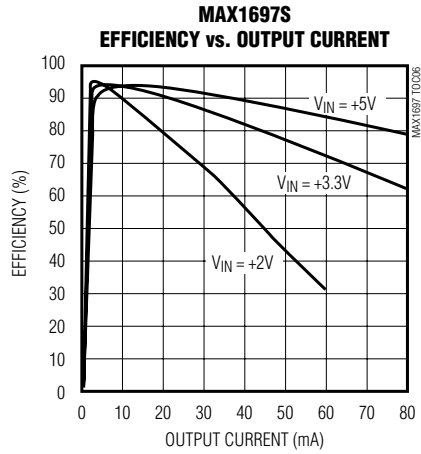
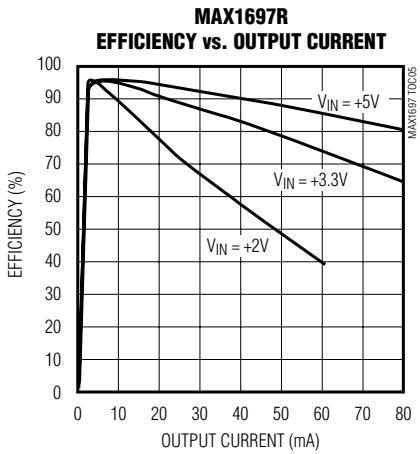
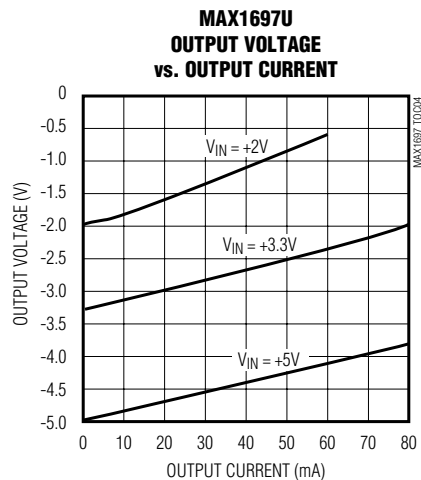
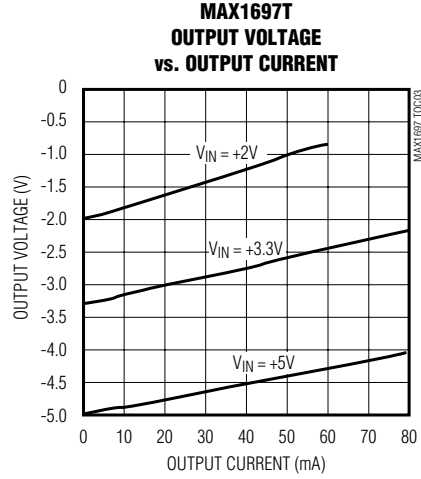
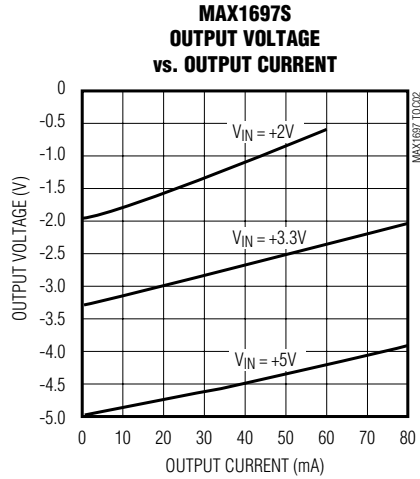
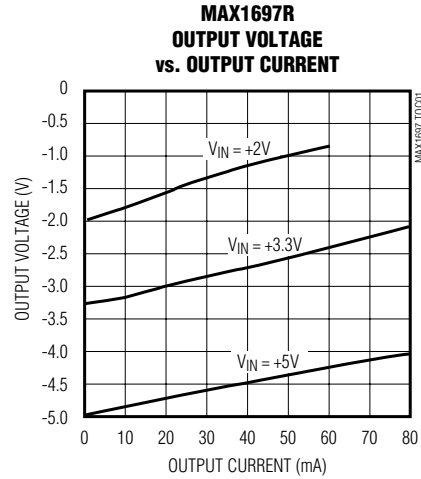

# 60mA, SOT23 Inverting Charge Pump with Shutdown

## Typical Operating Characteristics (continued)

(Circuit of Figure 1, capacitors from Table 2,  $V_{IN} = +5V$ ,  $\overline{SHDN} = IN$ ,  $T_A = +25^\circ C$ , unless otherwise noted.)

**MAX1697**

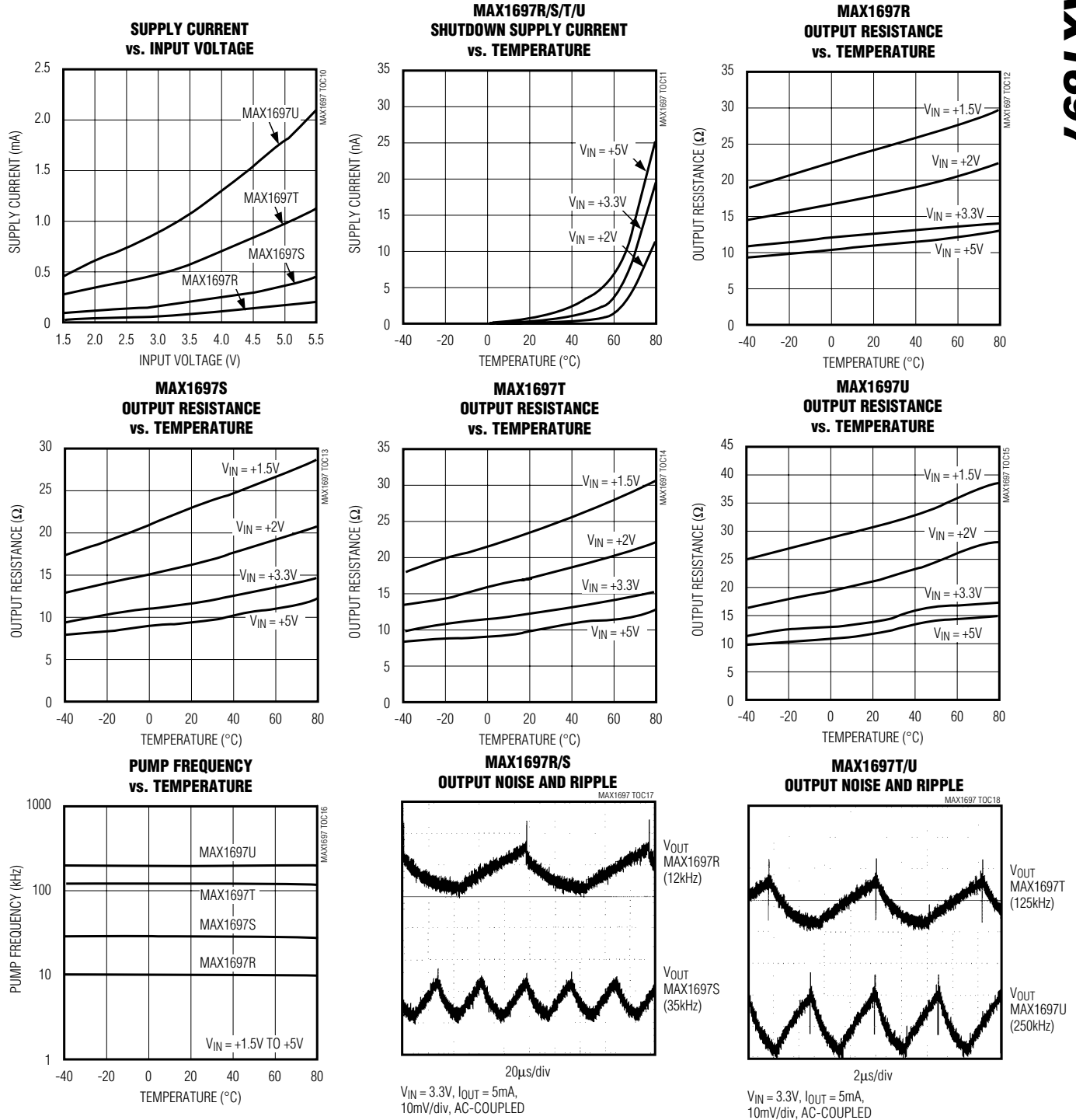

# 60mA, SOT23 Inverting Charge Pump with Shutdown

## Typical Operating Characteristics (continued)

(Circuit of Figure 1, capacitors from Table 2,  $V_{IN} = +5V$ ,  $\overline{SHDN} = IN$ ,  $T_A = +25^\circ C$ , unless otherwise noted.)

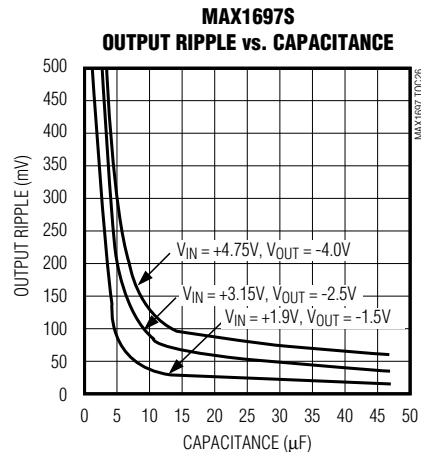
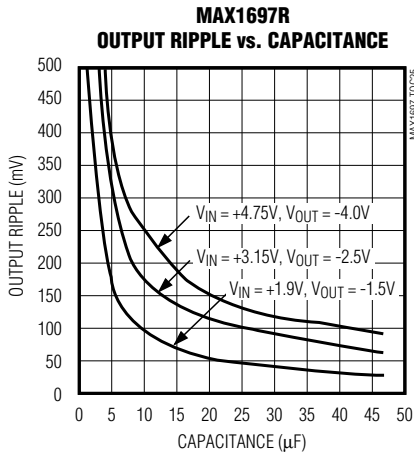
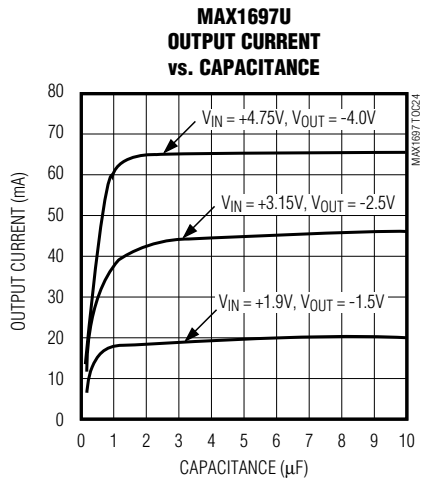
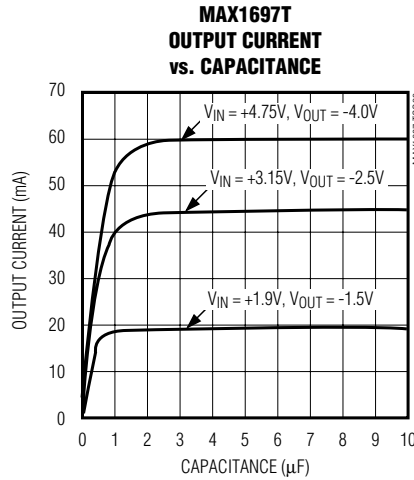
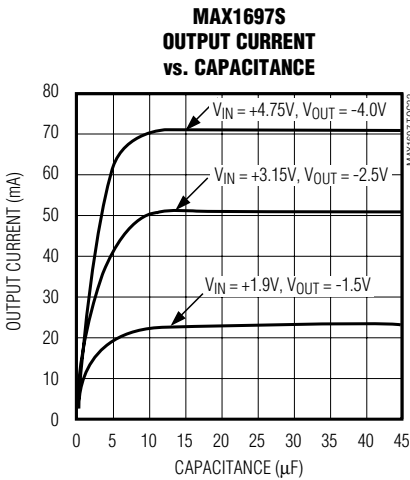
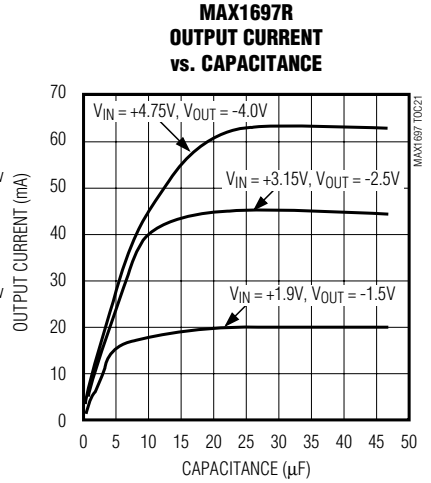
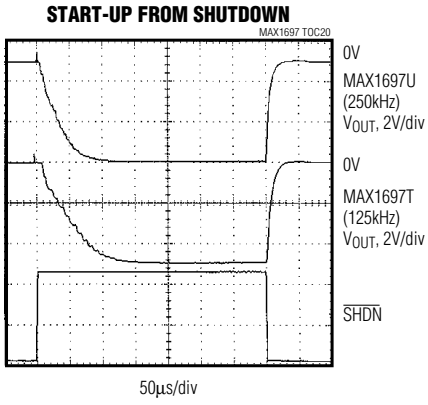
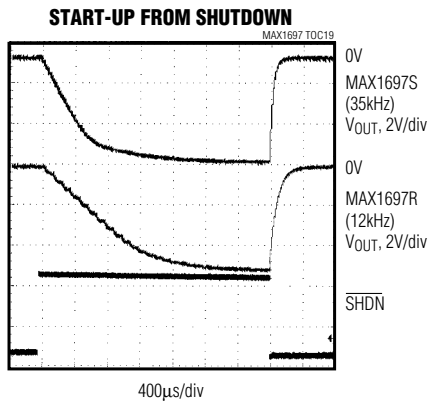

# 60mA, SOT23 Inverting Charge Pump with Shutdown

MAX1697

## Typical Operating Characteristics (continued)

(Circuit of Figure 1, capacitors from Table 2,  $V_{IN} = +5V$ ,  $\overline{SHDN} = IN$ ,  $T_A = +25^\circ C$ , unless otherwise noted.)

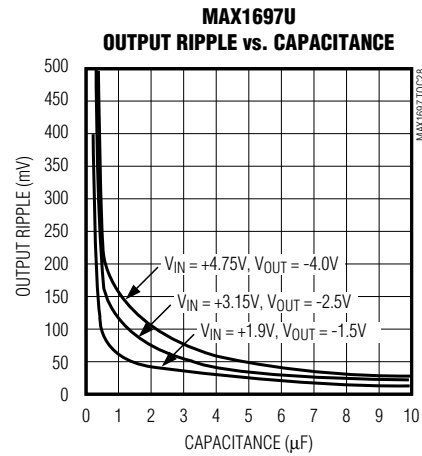
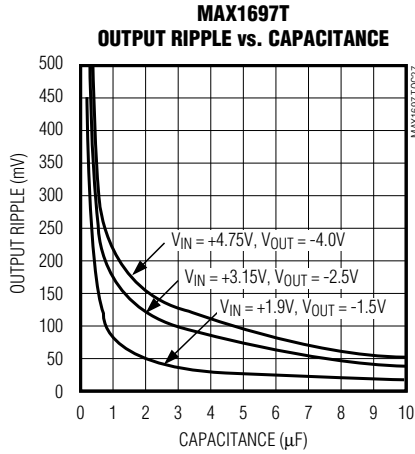

## Pin Description

| PIN | NAME              | FUNCTION  |
|-----|-------------------|---|
| 1   | OUT               | Inverting Charge-Pump Output  |
| 2   | IN                | Power-Supply Voltage Input. Input range is 1.5V to 5.5V.  |
| 3   | C1-               | Negative Terminal of the Flying Capacitor   |
| 4   | GND               | Ground  |
| 5   | $\overline{SHDN}$ | Shutdown Input. Drive this pin high for normal operation; drive it low for shutdown mode. OUT is actively pulled to ground during shutdown. |
| 6   | C1+               | Positive Terminal of the Flying Capacitor   |

## Detailed Description

The MAX1697 capacitive charge pumps invert the voltage applied to their input. For highest performance, use low equivalent series resistance (ESR) capacitors (e.g., ceramic).

During the first half-cycle, switches S2 and S4 open, switches S1 and S3 close, and capacitor C1 charges to the voltage at IN (Figure 2). During the second half-cycle, S1 and S3 open, S2 and S4 close, and C1 is level shifted downward by  $V_{IN}$  volts. This connects C1 in parallel with the reservoir capacitor C2. If the voltage across

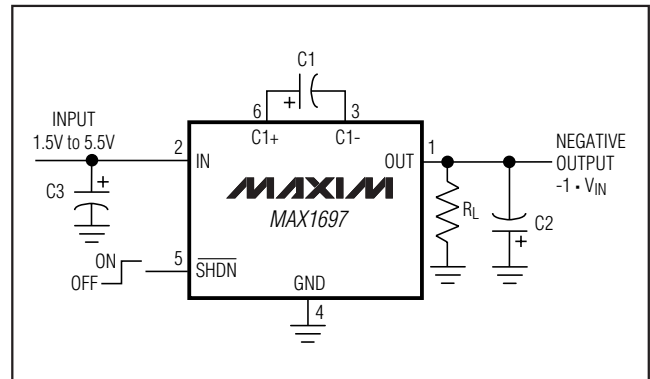

Figure 1. Typical Application Circuit

C2 is smaller than the voltage across C1, charge flows from C1 to C2 until the voltage across C2 reaches  $-V_{IN}$ . The actual voltage at the output is more positive than  $-V_{IN}$ , since switches S1–S4 have resistance and the load drains charge from C2.

## Efficiency Considerations

The efficiency of the MAX1697 is dominated by its quiescent supply current ( $I_Q$ ) at low output current and by its output impedance ( $R_{OUT}$ ) at higher output current; it is given by:

$$\eta \cong \frac{I_{OUT}}{I_{OUT} + I_Q} \left( 1 - \frac{I_{OUT} \cdot R_{OUT}}{V_{IN}} \right)$$

# 60mA, SOT23 Inverting Charge Pump with Shutdown

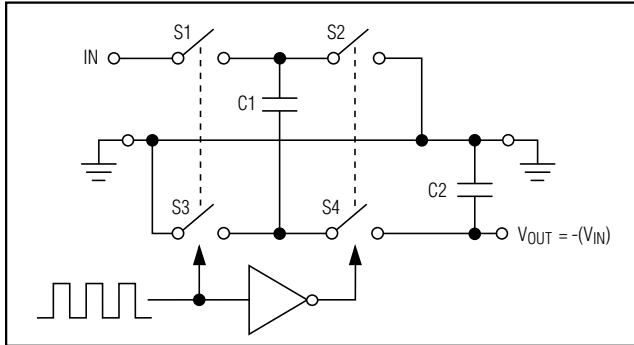

Figure 2. Ideal Voltage Inverter

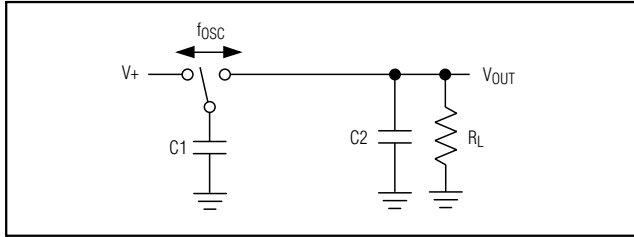

Figure 3a. Switched-Capacitor Model

where the output impedance is roughly approximated by:

$$R_{OUT} \cong \frac{1}{(f_{OSC}) \cdot C1} + 2R_{SW} + 4ESR_{C1} + ESR_{C2}$$

The first term is the effective resistance of an ideal switched-capacitor circuit (Figures 3a and 3b), and  $R_{SW}$  is the sum of the charge pump's internal switch resistances (typically  $4\Omega$  to  $5\Omega$  at  $V_{IN} = +5V$ ). The typical output impedance is more accurately determined from the *Typical Operating Characteristics*.

### Current Limit

The MAX1697 limits its input current upon start-up to 170mA (typ). This prevents low-current or higher output impedance input supplies (such as alkaline cells) from being overloaded when power is applied or when the device awakes from shutdown.

### Shutdown

The MAX1697 has a logic-controlled shutdown input. Driving  $\overline{SHDN}$  low places the device in a low-power shutdown mode. The charge-pump switching halts, supply current is reduced to 2nA, and OUT is actively pulled to ground through a  $3\Omega$  resistance.

Driving  $\overline{SHDN}$  high will restart the charge pump. The switching frequency and capacitor values determine how soon the device will reach 90% of the input voltage.

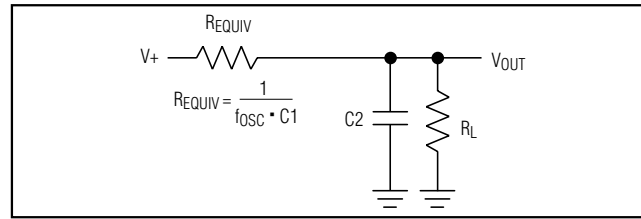

Figure 3b. Equivalent Circuit

### Thermal Shutdown

The MAX1697 has a thermal shutdown mode for additional protection against fault conditions. When the temperature of the die exceeds  $+150^{\circ}C$ , the internal clock stops, suspending the device's operation. The MAX1697 resumes operation when the die temperature falls  $15^{\circ}C$ . This prevents the device from rapidly oscillating around the temperature trip point.

## Applications Information

### Capacitor Selection

The charge-pump output resistance is a function of the ESR of C1 and C2. To maintain the lowest output resistance, use capacitors with low ESR. (See Table 1 for a list of recommended manufacturers.) Tables 2 and 3 suggest capacitor values for minimizing output resistance or capacitor size.

### Flying Capacitor (C1)

Increasing the flying capacitor's value reduces the output resistance. Above a certain point, increasing C1's capacitance has negligible effect because the output resistance is then dominated by internal switch resistance and capacitor ESR.

### Output Capacitor (C2)

Increasing the output capacitor's value reduces the output ripple voltage. Decreasing its ESR reduces both output resistance and ripple. Lower capacitance values can be used with light loads if higher output ripple can be tolerated. Use the following equation to calculate the peak-to-peak ripple:

$$V_{RIPPLE} = \frac{I_{OUT}}{2(f_{OSC})C2} + 2 \cdot I_{OUT} \cdot ESR_{C2}$$

### Input Bypass Capacitor (C3)

If necessary, bypass the incoming supply to reduce its AC impedance and the impact of the MAX1697's switching noise. A bypass capacitor with a value equal to that of C1 is recommended.



# 60mA, SOT23 Inverting Charge Pump with Shutdown

## Voltage Inverter

The most common application for these devices is a charge-pump voltage inverter (Figure 1). This application requires only two external components—capacitors C1 and C2—plus a bypass capacitor, if necessary. Refer to the *Capacitor Selection* section for suggested capacitor types.

## Cascading Devices

Two devices can be cascaded to produce an even larger negative voltage (Figure 4). The unloaded output voltage is normally  $-2 \cdot V_{IN}$ , but this is reduced slightly by the output resistance of the first device multiplied by the quiescent current of the second. When cascading more than two devices, the output resistance rises dramatically. For applications requiring larger negative voltages, see the MAX865 and MAX868 data sheets.

## Paralleling Devices

Paralleling multiple MAX1697s reduces the output resistance. Each device requires its own pump capacitor (C1), but the reservoir capacitor (C2) serves all devices (Figure 5). Increase C2's value by a factor of  $n$ , where  $n$  is the number of parallel devices. Figure 5 shows the equation for calculating output resistance.

## Combined Doubler/Inverter

In the circuit of Figure 6, capacitors C1 and C2 form the inverter, while C3 and C4 form the doubler. C1 and C3 are the pump capacitors; C2 and C4 are the reservoir capacitors. Because both the inverter and doubler use part of the charge-pump circuit, loading either output causes both outputs to decline toward GND. Make sure the sum of the currents drawn from the two outputs does not exceed 60mA.

## Heavy Load Connected to a Positive Supply

Under heavy loads, where a higher supply is sourcing current into OUT, the OUT supply must not be pulled above ground. Applications that sink heavy current into OUT require a Schottky diode (1N5817) between GND and OUT, with the anode connected to OUT (Figure 7).

## Layout and Grounding

Good layout is important, primarily for good noise performance. To ensure good layout, mount all components as close together as possible, keep traces short to minimize parasitic inductance and capacitance, and use a ground plane.

**Table 1. Low-ESR Capacitor Manufacturers**

| PRODUCTION METHOD      | MANUFACTURER | SERIES            | PHONE        | FAX          |
|------------------------|--------------|-------------------|--------------|--------------|
| Surface-Mount Tantalum | AVX          | TPS series        | 803-946-0690 | 803-626-3123 |
|                        | Matsuo       | 267 series        | 714-969-2491 | 714-960-6492 |
|                        | Sprague      | 593D, 595D series | 603-224-1961 | 603-224-1430 |
| Surface-Mount Ceramic  | AVX          | X7R               | 803-946-0690 | 803-626-3123 |
|                        | Matsuo       | X7R               | 714-969-2491 | 714-960-6492 |

**Table 2. Capacitor Selection to Minimize Output Resistance**

| PART     | FREQUENCY (kHz) | CAPACITOR ( $\mu$ F) | TYPICAL $R_{OUT}$ ( $\Omega$ ) |
|----------|-----------------|----------------------|--------------------------------|
| MAX1697R | 12              | 22                   | 12                             |
| MAX1697S | 35              | 6.8                  | 12                             |
| MAX1697T | 125             | 2.2                  | 12                             |
| MAX1697U | 250             | 1                    | 12                             |

**Table 3. Capacitor Selection to Minimize Capacitor Size**

| PART     | FREQUENCY (kHz) | CAPACITOR ( $\mu$ F) | TYPICAL $R_{OUT}$ ( $\Omega$ ) |
|----------|-----------------|----------------------|--------------------------------|
| MAX1697R | 12              | 10                   | 17                             |
| MAX1697S | 35              | 3.3                  | 17                             |
| MAX1697T | 125             | 1                    | 17                             |
| MAX1697U | 250             | 0.47                 | 17                             |

# 60mA, SOT23 Inverting Charge Pump with Shutdown

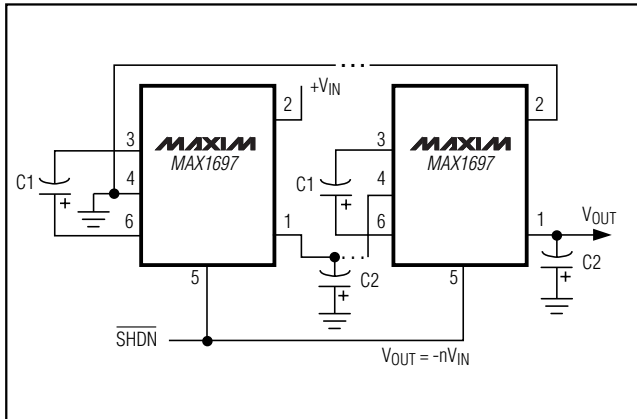

Figure 4. Cascading MAX1697s to Increase Output Voltage

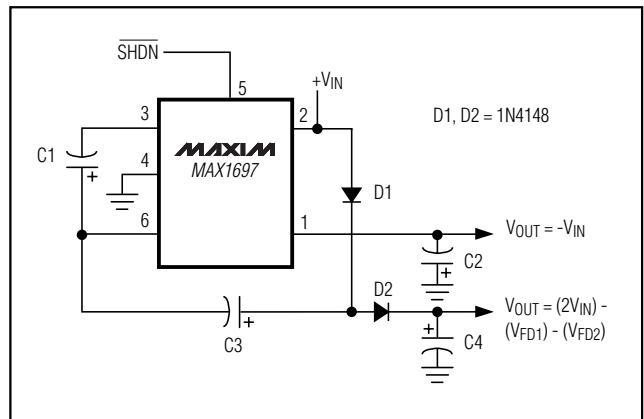

Figure 6. Combined Doubler and Inverter

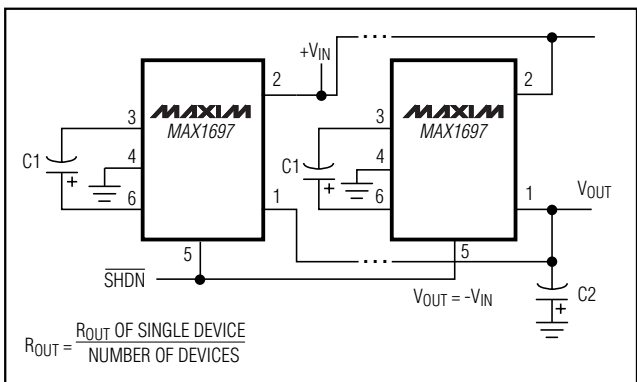

Figure 5. Paralleling MAX1697s to Reduce Output Resistance

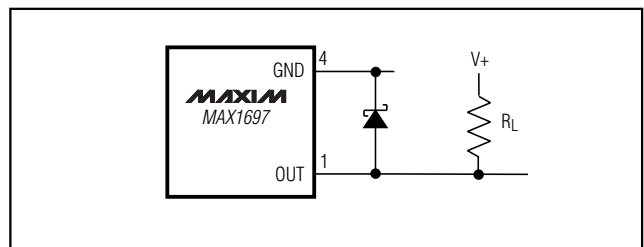

Figure 7. Heavy Load Connected to a Positive Supply

$$R_{OUT} = \frac{R_{OUT \text{ OF SINGLE DEVICE}}}{\text{NUMBER OF DEVICES}}$$

## Chip Information

TRANSISTOR COUNT: 275

# 60mA, SOT23 Inverting Charge Pump with Shutdown

## Package Information

**MAX1697**

6LSOT.EPS

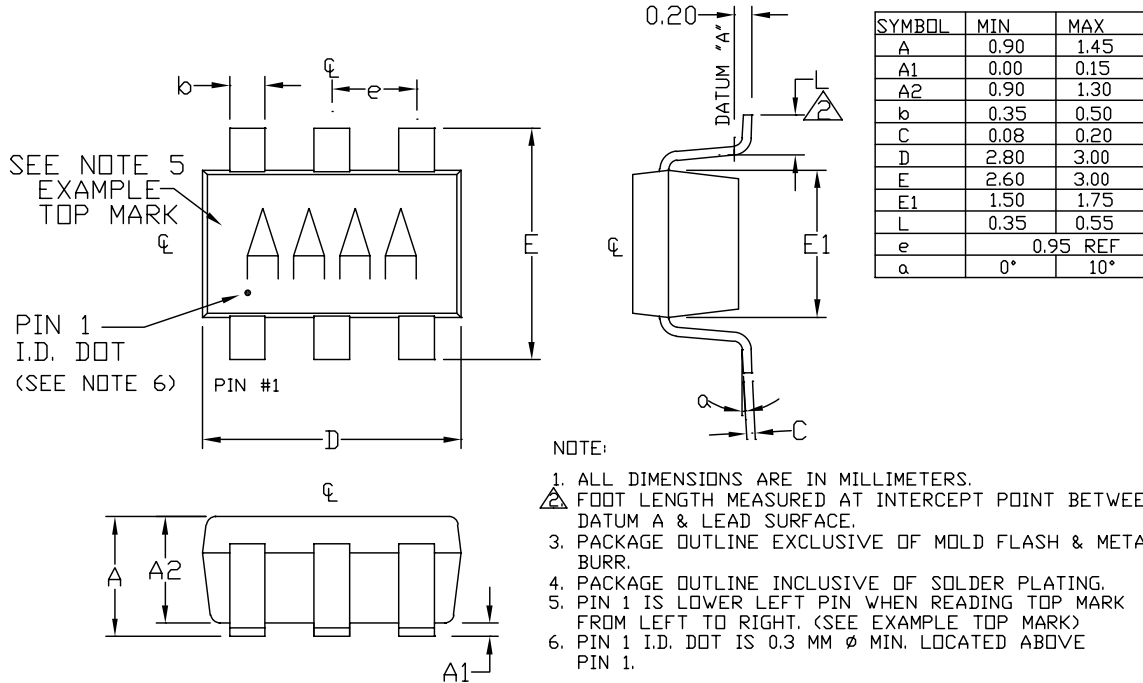

**MAXIM**  
 PROPRIETARY INFORMATION  
 TITLE:  
 PACKAGE OUTLINE, SOT23, 6L  
 APPROVAL: \_\_\_\_\_ DOCUMENT CONTROL NO. 21-0058 REV D 1/1

**MAX1697**

# **60mA, SOT23 Inverting Charge Pump with Shutdown**

## NOTES

*Maxim cannot assume responsibility for use of any circuitry other than circuitry entirely embodied in a Maxim product. No circuit patent licenses are implied. Maxim reserves the right to change the circuitry and specifications without notice at any time.*

**12** \_\_\_\_\_ **Maxim Integrated Products, 120 San Gabriel Drive, Sunnyvale, CA 94086 408-737-7600**

© 1999 Maxim Integrated Products

Printed USA

**MAXIM** is a registered trademark of Maxim Integrated Products.