

100MHz to 70GHz Linear-in-dB RMS Power Detector with 35dB Dynamic Range

FEATURES

- **Ultra Wide Matched Input Frequency Range: 100MHz to 70GHz**
- **35dB Linear Dynamic Range (< ±1dB Error)**
- **28.5mV/dB Logarithmic Slope**
- **±2dB Flat Response from 100MHz to 60GHz**
- **Accurate RMS Power Measurement of High Crest Factors (Up to 12dB) Modulated Waveforms**
- **Low Power Shutdown Mode**
- Low Supply Current: 33mA at 3.3V (Typical)
- Small 2mm × 2mm Plastic DFN8 Package
- I-Grade: -40°C to 105°C Rated
H-Grade: -40°C to 125°C Rated
with Guaranteed Log-Slope and Log-Intercept
- ESD Rating: 2500V HBM, 1500V CDM

APPLICATIONS

- Point-to-Point Microwave Links
- SATCOM
- Instrumentation and Measurement Equipment
- Military Radios
- 5G, LTE, WiFi, Wireless Networks
- RMS Power Measurement
- Receive and Transmit Gain Control
- RF PA Transmit Power Control

DESCRIPTION

The **LTC[®]5597** is a high accuracy RMS power detector that provides a very wide RF input bandwidth, from 100MHz up to 70GHz. This makes the device suitable for a wide range of RF and microwave applications, such as point-to-point microwave links, instrumentation and power control applications.

The DC output voltage of the detector is an accurate representation of the average signal power applied to the RF input. The response is linear-in-dB with 28.5mV/dB logarithmic slope over a 35dB dynamic range with typically better than ±1dB accuracy. The detector is particularly suited for measurement of waveforms with crest factor (CF) as high as 12dB, and waveforms that exhibit a significant variation of the crest factor during measurement.

To achieve higher accuracy and lower output ripple, the averaging bandwidth can be externally adjusted by a capacitor connected between the FLTR and OUT pins.

The enable interface switches the device between active measurement mode and a low power shutdown mode.

All registered trademarks and trademarks are the property of their respective owners. Protected by U.S. patents, including 9330283, 9639719.

TYPICAL APPLICATION

100MHz to 70GHz RMS Power Detector

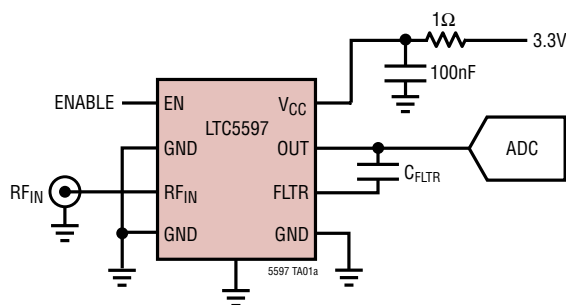

Output Voltage vs Frequency

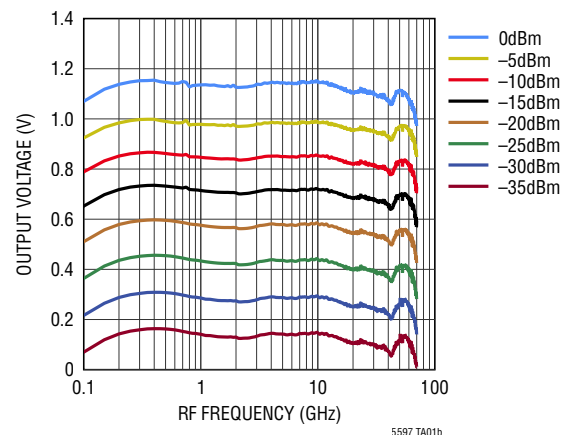

ABSOLUTE MAXIMUM RATINGS

(Note 1)

Supply Voltage (V_{CC})	3.8V
RF_{IN} Input Signal Power - Average	15dBm
RF_{IN} Input Signal Power - Peak (Note 2)	20dBm
DC Voltage at RF_{IN}	-0.3V to 1V
DC Voltage at FLTR	-0.3V to 0.4V
DC Voltage at EN	-0.3V to 3.8V
T_{JMAX}	150°C
Case Operating Temperature Range (T_C):	
I-Grade (Note 3)	-40°C to 105°C
H-Grade (Note 4)	-40°C to 125°C
Storage Temperature Range	-65°C to 150°C

PIN CONFIGURATION

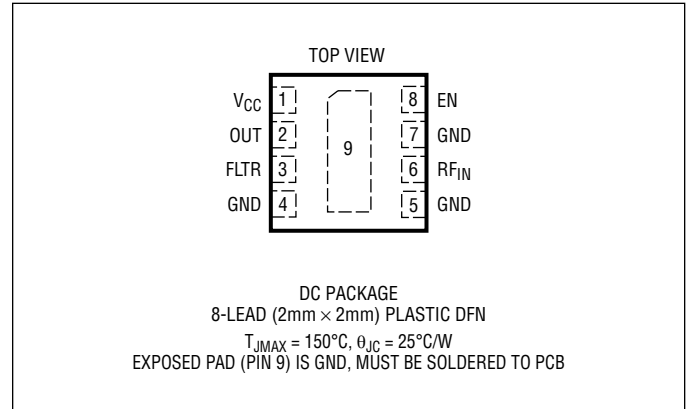

ORDER INFORMATION

LEAD FREE FINISH	TAPE AND REEL	PART MARKING*	PACKAGE DESCRIPTION	TEMPERATURE RANGE
LTC5597IDC#PBF	LTC5597IDC#TRPBF	LHKF	8-Lead 2mm x 2mm Plastic DFN	-40°C to 105°C
LTC5597HDC#PBF	LTC5597HDC#TRPBF	LHKF	8-Lead 2mm x 2mm Plastic DFN	-40°C to 125°C

Contact the factory for parts specified with wider operating temperature ranges. *The temperature grade is identified by a label on the shipping container.

[Tape and reel specifications](#). Some packages are available in 500 unit reels through designated sales channels with #TRMPBF suffix.

ELECTRICAL CHARACTERISTICS

The ● denotes the specifications which apply over the full operating temperature range, otherwise specifications are at $T_C = 25^\circ\text{C}$. $V_{CC} = 3.3\text{V}$, $EN = 3.3\text{V}$. CW, 50Ω source at RF_{IN} , $f_{RF} = 2.7\text{GHz}$, test circuit is shown in Figure 1.

PARAMETER	CONDITIONS	I-GRADE (NOTE 3)			H-GRADE (NOTE 4)			UNITS
		MIN	TYP	MAX	MIN	TYP	MAX	
RF Input								
Input Frequency Range			0.1 to 70		0.1 to 70			GHz
Input Impedance			50 50		50 50			Ω fF
Detector Response (RF_{IN} to OUT)								
RF Input Power Range, $T_C = 25^\circ\text{C}$	$f_{RF} = 100\text{MHz}$		-38.2 to 4.5		-38.2 to 4.5			dBm
$\pm 1\text{dB}$ LOG-Linearity Error (Note 5, 6)	$f_{RF} = 500\text{MHz}$		-41.7 to 3.2		-41.7 to 3.2			dBm
	$f_{RF} = 1\text{GHz}$		-40.8 to 3.5		-40.8 to 3.5			dBm
	$f_{RF} = 2.7\text{GHz}$		-40.1 to 3.5		-40.1 to 3.5			dBm
	$f_{RF} = 5.8\text{GHz}$		-40.6 to 3.3		-40.6 to 3.3			dBm
	$f_{RF} = 10\text{GHz}$		-41.1 to 3.0		-41.1 to 3.0			dBm
	$f_{RF} = 15\text{GHz}$		-40.2 to 3.7		-40.2 to 3.7			dBm
	$f_{RF} = 18\text{GHz}$		-40.0 to 3.6		-40.0 to 3.6			dBm
	$f_{RF} = 24\text{GHz}$		-40.0 to 3.6		-40.0 to 3.6			dBm
	$f_{RF} = 28\text{GHz}$		-39.3 to 4.3		-39.3 to 4.3			dBm
	$f_{RF} = 30\text{GHz}$		-38.7 to 4.7		-38.7 to 4.7			dBm
	$f_{RF} = 39\text{GHz}$		-38.0 to 5.2		-38.0 to 5.2			dBm
	$f_{RF} = 42\text{GHz}$		-38.1 to 5.0		-38.1 to 5.0			dBm
	$f_{RF} = 50\text{GHz}$		-40.0 to 3.0		-40.0 to 3.0			dBm
	$f_{RF} = 52\text{GHz}$		-40.0 to 2.8		-40.0 to 2.8			dBm
	$f_{RF} = 60\text{GHz}$		-39.4 to 1.5		-39.4 to 1.5			dBm
	$f_{RF} = 67\text{GHz}$		-38.3 to 0.2		-38.3 to 0.2			dBm
	$f_{RF} = 70\text{GHz}$		-36.1 to 1.9		-36.1 to 1.9			dBm

ELECTRICAL CHARACTERISTICS The ● denotes the specifications which apply over the full operating temperature range, otherwise specifications are at $T_C = 25^\circ\text{C}$. $V_{CC} = 3.3\text{V}$, $EN = 3.3\text{V}$. CW, 50Ω source at RF_{IN} , $f_{RF} = 2.7\text{GHz}$, test circuit is shown in Figure 1.

PARAMETER	CONDITIONS		I-GRADE (NOTE 3)			H-GRADE (NOTE 4)			UNITS
			MIN	TYP	MAX	MIN	TYP	MAX	
RF Input Power Range Over Operating Temperature Range $\pm 1\text{dB}$ LOG-Linearity Error (Note 5, 6)	$f_{RF} = 100\text{MHz}$	●		-38.1 to 3.3			-37.1 to 1.2		dBm
	$f_{RF} = 500\text{MHz}$	●		-38.4 to -0.6			-36.1 to -0.6		dBm
	$f_{RF} = 1\text{GHz}$	●		-38.5 to -0.3			-36.7 to -0.3		dBm
	$f_{RF} = 2.7\text{GHz}$	●		-40.1 to 0.2			-36.6 to 0.2		dBm
	$f_{RF} = 5.8\text{GHz}$	●		-39.6 to -0.3			-37.0 to -0.3		dBm
	$f_{RF} = 10\text{GHz}$	●		-39.0 to -0.9			-37.0 to -0.9		dBm
	$f_{RF} = 15\text{GHz}$	●		-38.6 to -0.1			-36.2 to 0.1		dBm
	$f_{RF} = 18\text{GHz}$	●		-40.0 to 0.3			-36.4 to 0.3		dBm
	$f_{RF} = 24\text{GHz}$	●		-40.0 to 0.1			-36.6 to 0.1		dBm
	$f_{RF} = 28\text{GHz}$	●		-39.2 to 0.8			-36.0 to 0.8		dBm
	$f_{RF} = 30\text{GHz}$	●		-38.7 to 1.7			-37.2 to 1.7		dBm
	$f_{RF} = 39\text{GHz}$	●		-37.9 to 3.0			-36.7 to 2.1		dBm
	$f_{RF} = 42\text{GHz}$	●		-38.1 to 2.0			-38.1 to 1.2		dBm
	$f_{RF} = 50\text{GHz}$	●		-40.0 to -0.2			-36.3 to -2.9		dBm
$f_{RF} = 52\text{GHz}$	●		-39.4 to -0.8			-35.4 to -4.0		dBm	
$\pm 2\text{dB}$ LOG-Linearity Error (Note 5, 6)	$f_{RF} = 60\text{GHz}$	●		-40.0 to -0.9			-34.9 to -3.7		dBm
$\pm 3\text{dB}$ LOG-Linearity Error (Note 5, 6)	$f_{RF} = 67\text{GHz}$	●		-40.1 to -0.2			-31.1 to -4.3		dBm
$\pm 3\text{dB}$ LOG-Linearity Error (Note 5, 6)	$f_{RF} = 70\text{GHz}$	●		-36.1 to -0.1					dBm
$\pm 3.5\text{dB}$ LOG-Linearity Error (Note 5, 6)	$f_{RF} = 70\text{GHz}$	●					-27.6 to -3.2		dBm
Linear Dynamic Range, $T_C = 25^\circ\text{C}$ (Note 6)	$f_{RF} = 100\text{MHz}$			42.7			42.7		dB
	$f_{RF} = 500\text{MHz}$			44.8			44.8		dB
	$f_{RF} = 1\text{GHz}$			44.3			44.3		dB
	$f_{RF} = 2.7\text{GHz}$			43.7			43.7		dB
	$f_{RF} = 5.8\text{GHz}$			43.9			43.9		dB
	$f_{RF} = 10\text{GHz}$			44.0			44.0		dB
	$f_{RF} = 15\text{GHz}$			43.8			43.8		dB
	$f_{RF} = 18\text{GHz}$			43.6			43.6		dB
	$f_{RF} = 24\text{GHz}$			43.7			43.7		dB
	$f_{RF} = 28\text{GHz}$			43.6			43.6		dB
	$f_{RF} = 30\text{GHz}$			43.5			43.5		dB
	$f_{RF} = 39\text{GHz}$			43.3			43.3		dB
	$f_{RF} = 42\text{GHz}$			43.2			43.2		dB
	$f_{RF} = 50\text{GHz}$			43.0			43.0		dB
$f_{RF} = 52\text{GHz}$			42.8			42.8		dB	
$f_{RF} = 60\text{GHz}$			40.9			40.9		dB	
$f_{RF} = 67\text{GHz}$			38.4			38.4		dB	
$f_{RF} = 70\text{GHz}$			38.0			38.0		dB	
Linear Dynamic Range Over Operating Temperature Range $\pm 1\text{dB}$ LOG-Linearity Error (Note 6)	$f_{RF} = 100\text{MHz}$	●		41.5			38.3		dB
	$f_{RF} = 500\text{MHz}$	●		37.8			35.5		dB
	$f_{RF} = 1\text{GHz}$	●		38.2			36.5		dB
	$f_{RF} = 2.7\text{GHz}$	●		40.3			36.8		dB
	$f_{RF} = 5.8\text{GHz}$	●		39.3			36.7		dB
	$f_{RF} = 10\text{GHz}$	●		38.1			36.1		dB
	$f_{RF} = 15\text{GHz}$	●		38.5			36.3		dB
	$f_{RF} = 18\text{GHz}$	●		40.4			36.8		dB
	$f_{RF} = 24\text{GHz}$	●		40.2			36.8		dB
	$f_{RF} = 28\text{GHz}$	●		40.1			36.9		dB
	$f_{RF} = 30\text{GHz}$	●		40.4			38.9		dB
	$f_{RF} = 39\text{GHz}$	●		40.9			38.8		dB
	$f_{RF} = 42\text{GHz}$	●		40.1			39.3		dB
	$f_{RF} = 50\text{GHz}$	●		39.8			33.4		dB
$f_{RF} = 52\text{GHz}$	●		38.6			31.4		dB	
$\pm 2\text{dB}$ LOG-Linearity Error (Note 5, 6)	$f_{RF} = 60\text{GHz}$	●		39.1			31.3		dB
$\pm 3\text{dB}$ LOG-Linearity Error (Note 5, 6)	$f_{RF} = 67\text{GHz}$	●		39.9			26.8		dB
$\pm 3\text{dB}$ LOG-Linearity Error (Note 5, 6)	$f_{RF} = 70\text{GHz}$	●		36.1					dB
$\pm 3.5\text{dB}$ LOG-Linearity Error (Note 5, 6)	$f_{RF} = 70\text{GHz}$	●					24.4		dB

ELECTRICAL CHARACTERISTICS The ● denotes the specifications which apply over the full operating temperature range, otherwise specifications are at $T_C = 25^\circ\text{C}$. $V_{CC} = 3.3\text{V}$, $EN = 3.3\text{V}$. CW, 50Ω source at RF_{IN} , $f_{RF} = 2.7\text{GHz}$, test circuit is shown in Figure 1.

PARAMETER	CONDITIONS	I-GRADE (NOTE 3)			H-GRADE (NOTE 4)			UNITS
		MIN	TYP	MAX	MIN	TYP	MAX	
Logarithmic Slope, $T_C = 25^\circ\text{C}$ (Note 7)	$f_{RF} = 100\text{MHz}$		28.6			28.6		mV/dB
	$f_{RF} = 500\text{MHz}$		27.7			27.7		mV/dB
	$f_{RF} = 1\text{GHz}$		28.0			28.0		mV/dB
	$f_{RF} = 2.7\text{GHz}$		28.5		27.1	28.5	29.5	mV/dB
	$f_{RF} = 5.8\text{GHz}$		28.3			28.3		mV/dB
	$f_{RF} = 10\text{GHz}$		28.2			28.2		mV/dB
	$f_{RF} = 15\text{GHz}$		28.4			28.4		mV/dB
	$f_{RF} = 18\text{GHz}$		28.5			28.5		mV/dB
	$f_{RF} = 24\text{GHz}$		28.5			28.5		mV/dB
	$f_{RF} = 28\text{GHz}$		28.6			28.6		mV/dB
	$f_{RF} = 30\text{GHz}$		28.6			28.6		mV/dB
	$f_{RF} = 39\text{GHz}$		28.7			28.7		mV/dB
	$f_{RF} = 42\text{GHz}$		28.7			28.7		mV/dB
	$f_{RF} = 50\text{GHz}$		28.3			28.3		mV/dB
	$f_{RF} = 52\text{GHz}$		28.3			28.3		mV/dB
	$f_{RF} = 60\text{GHz}$		28.3			28.3		mV/dB
$f_{RF} = 67\text{GHz}$		28.3			28.3		mV/dB	
$f_{RF} = 70\text{GHz}$		28.0			28.0		mV/dB	
Logarithmic Slope Over Operating Temperature Range (Note 7)	$f_{RF} = 100\text{MHz}$	●	27.9 to 29.2		26.4	27.9 to 29.2		mV/dB
	$f_{RF} = 500\text{MHz}$	●	26.9 to 28.4			26.9 to 28.4		mV/dB
	$f_{RF} = 1\text{GHz}$	●	27.3 to 28.7			27.3 to 28.7		mV/dB
	$f_{RF} = 2.7\text{GHz}$	●	27.8 to 29.1			27.8 to 29.1	30.4	mV/dB
	$f_{RF} = 5.8\text{GHz}$	●	27.6 to 28.9			27.6 to 28.9		mV/dB
	$f_{RF} = 10\text{GHz}$	●	27.5 to 28.8			27.5 to 28.8		mV/dB
	$f_{RF} = 15\text{GHz}$	●	27.7 to 29.0			27.7 to 29.0		mV/dB
	$f_{RF} = 18\text{GHz}$	●	27.8 to 29.1			27.8 to 29.1		mV/dB
	$f_{RF} = 24\text{GHz}$	●	27.8 to 29.1			27.8 to 29.1		mV/dB
	$f_{RF} = 28\text{GHz}$	●	27.9 to 29.2			27.9 to 29.2		mV/dB
	$f_{RF} = 30\text{GHz}$	●	27.9 to 29.3			27.9 to 29.3		mV/dB
	$f_{RF} = 39\text{GHz}$	●	28.0 to 29.3			28.0 to 29.3		mV/dB
	$f_{RF} = 42\text{GHz}$	●	28.0 to 29.3			28.0 to 29.3		mV/dB
	$f_{RF} = 50\text{GHz}$	●	27.7 to 28.9			27.7 to 28.9		mV/dB
	$f_{RF} = 52\text{GHz}$	●	27.7 to 28.9			27.7 to 28.9		mV/dB
	$f_{RF} = 60\text{GHz}$	●	27.6 to 28.9			27.6 to 28.9		mV/dB
$f_{RF} = 67\text{GHz}$	●	27.6 to 28.7			27.6 to 28.7		mV/dB	
$f_{RF} = 70\text{GHz}$	●	27.2 to 28.0			26.6 to 28.0		mV/dB	
Logarithmic Intercept, $T_C = 25^\circ\text{C}$ (Note 8)	$f_{RF} = 100\text{MHz}$		-37.2			-37.2		dBm
	$f_{RF} = 500\text{MHz}$		-40.7			-40.7		dBm
	$f_{RF} = 1\text{GHz}$		-39.9			-39.9		dBm
	$f_{RF} = 2.7\text{GHz}$		-39.2		-40.6	-39.2	-38.0	dBm
	$f_{RF} = 5.8\text{GHz}$		-39.7			-39.7		dBm
	$f_{RF} = 10\text{GHz}$		-40.1			-40.1		dBm
	$f_{RF} = 15\text{GHz}$		-39.2			-39.2		dBm
	$f_{RF} = 18\text{GHz}$		-39.1			-39.1		dBm
	$f_{RF} = 24\text{GHz}$		-39.1			-39.1		dBm
	$f_{RF} = 28\text{GHz}$		-38.3			-38.3		dBm
	$f_{RF} = 30\text{GHz}$		-37.8			-37.8		dBm
	$f_{RF} = 39\text{GHz}$		-37.1			-37.1		dBm
	$f_{RF} = 42\text{GHz}$		-37.2			-37.2		dBm
	$f_{RF} = 50\text{GHz}$		-39.1			-39.1		dBm
	$f_{RF} = 52\text{GHz}$		-39.0			-39.0		dBm
	$f_{RF} = 60\text{GHz}$		-38.4			-38.4		dBm
$f_{RF} = 67\text{GHz}$		-37.3			-37.3		dBm	
$f_{RF} = 70\text{GHz}$		-35.2			-35.2		dBm	

ELECTRICAL CHARACTERISTICS The ● denotes the specifications which apply over the full operating temperature range, otherwise specifications are at $T_C = 25^\circ\text{C}$. $V_{CC} = 3.3\text{V}$, $EN = 3.3\text{V}$. CW, 50Ω source at RF_{IN} , $f_{RF} = 2.7\text{GHz}$, test circuit is shown in Figure 1.

PARAMETER	CONDITIONS		I-GRADE (NOTE 3)			H-GRADE (NOTE 4)			UNITS	
			MIN	TYP	MAX	MIN	TYP	MAX		
Logarithmic Intercept Over Operating Temperature Range (Note 8)	$f_{RF} = 100\text{MHz}$	●		-37.6 to -36.6			-37.6 to -36.4		dBm	
	$f_{RF} = 500\text{MHz}$	●		-41.3 to -39.9			-41.3 to -39.7		dBm	
	$f_{RF} = 1\text{GHz}$	●		-40.3 to -39.0			-40.3 to -38.8		dBm	
	$f_{RF} = 2.7\text{GHz}$	●		-39.6 to -38.4		-41.6	-39.6 to -38.2	-37.2	dBm	
	$f_{RF} = 5.8\text{GHz}$	●		-40.1 to -38.9			-40.1 to -38.7		dBm	
	$f_{RF} = 10\text{GHz}$	●		-40.6 to -39.3			-40.6 to -39.1		dBm	
	$f_{RF} = 15\text{GHz}$	●		-39.7 to -38.4			-39.7 to -38.1		dBm	
	$f_{RF} = 18\text{GHz}$	●		-39.5 to -38.3			-39.5 to -38.0		dBm	
	$f_{RF} = 24\text{GHz}$	●		-39.5 to -38.3			-39.5 to -38.1		dBm	
	$f_{RF} = 28\text{GHz}$	●		-38.7 to -37.5			-38.7 to -37.2		dBm	
	$f_{RF} = 30\text{GHz}$	●		-38.2 to -37.0			-38.2 to -36.8		dBm	
	$f_{RF} = 39\text{GHz}$	●		-37.4 to -36.4			-37.4 to -36.2		dBm	
	$f_{RF} = 42\text{GHz}$	●		-37.4 to -36.6			-37.4 to -36.4		dBm	
	$f_{RF} = 50\text{GHz}$	●		-39.4 to -38.3			-39.4 to -38.0		dBm	
	$f_{RF} = 52\text{GHz}$	●		-39.3 to -38.2			-39.3 to -37.8		dBm	
	$f_{RF} = 60\text{GHz}$	●		-39.5 to -36.7			-39.5 to -36.3		dBm	
	$f_{RF} = 67\text{GHz}$	●		-38.3 to -35.0			-38.3 to -34.5		dBm	
$f_{RF} = 70\text{GHz}$	●		-36.9 to -33.2			-36.9 to -32.7		dBm		
RF Input Power Range for Various Modulation Formats (Note 9)	CDMA 9Ch fwd			-40.1 to 2.3			-40.1 to 2.3		dBm	
	CDMA 32Ch fwd			-40.0 to 2.3			-40.0 to 2.3		dBm	
	CDMA 64Ch fwd			-39.8 to 2.3			-39.8 to 2.3		dBm	
	CDMA 3 Carriers			-40.8 to 1.8			-40.8 to 1.8		dBm	
	CDMA 4 Carriers			-40.6 to 2.6			-40.6 to 2.6		dBm	
	WCDMA 1Ch Up			-40.2 to 2.8			-40.2 to 2.8		dBm	
	WCDMA 1Ch Down			-40.1 to 2.8			-40.1 to 2.8		dBm	
	WCDMA 2 Carriers			-40.2 to 1.8			-40.2 to 1.8		dBm	
	WCDMA 3 Carriers			-40.7 to 1.2			-40.7 to 1.2		dBm	
	WCDMA 4 Carriers			-40.8 to 1.8			-40.8 to 1.8		dBm	
	AWGN 5MHz BW			-40.6 to 1.9			-40.6 to 1.9		dBm	
	AWGN 10MHz BW			-40.4 to 2.6			-40.4 to 2.6		dBm	
AWGN 15MHz BW			-40.3 to 2.7			-40.3 to 2.7		dBm		
Propagation Delay (Note 10)	P_{IN} from -55dBm to 0dBm			1.2			1.2		μs	
OUT Interface										
Output DC Voltage	No RF Signal Present $EN = 1.1\text{V}$			1.0	5.0		1.0	5.0		mV
	$P_{IN} = 10\text{dBm}$ $EN = 1.1\text{V}$		1.150	1.2	1.250	1.150	1.2	1.250		V
Output Voltage Droop	25mA Sourcing		-35	6	20	-35	6	20		mV
	25mA Sinking			30			30			mV
Integrated Output Noise	1kHz to 6.5kHz $P_{IN} = 0\text{dBm}$			22			22			μV_{RMS}
Rise Time (Note 11)	50Ω Load at OUT			2.9			2.9			μs
Fall Time (Note 12)	50Ω Load at OUT			8.1			8.1			μs

ELECTRICAL CHARACTERISTICS The ● denotes the specifications which apply over the full operating temperature range, otherwise specifications are at $T_C = 25^\circ\text{C}$. $V_{CC} = 3.3\text{V}$, $EN = 3.3\text{V}$. CW, 50Ω source at RF_{IN} , $f_{RF} = 2.7\text{GHz}$, test circuit is shown in Figure 1.

PARAMETER	CONDITIONS		I-GRADE (NOTE 3)			H-GRADE (NOTE 4)			UNITS
			MIN	TYP	MAX	MIN	TYP	MAX	
Enable (EN) Low = Off, High = On									
EN Input High Voltage (On)		●	1.1			1.1			V
EN Input Low Voltage (Off)		●			0.6			0.6	V
EN Pin Input Current				50	500		50	500	nA
Turn ON Time (Note 13)	50Ω Load at OUT			8			8		μs
Turn OFF Time (Note 14)	50Ω Load at OUT $1\text{M}\Omega 11\text{pF}$ Load at OUT			45 100			45 100		ns μs
Power Supply									
Supply Voltage		●	2.7	3.3	3.6	2.7	3.3	3.6	V
Active Supply Current	$EN = 3.3\text{V}$		29.8	33.5	37.3	29.8	33.5	37.3	mA
Shutdown Supply Current	$EN = 0\text{V}$			50	500		50	500	nA

Note 1: Stresses beyond those listed under Absolute Maximum Ratings may cause permanent damage to the device. Exposure to any Absolute Maximum Rating condition for extended periods may affect device reliability and lifetime. The voltage on all pins should not exceed 3.8V , $V_{CC} + 0.3\text{V}$ or be less than -0.3V , otherwise damage to the ESD diodes may occur.

Note 2: Not production tested. Guaranteed by design and correlation to production tested parameters.

Note 3: The LTC5597IDC is guaranteed functional over the case temperature range -40°C to 105°C . All limits at -40°C and 105°C are guaranteed by design and production sample testing.

Note 4: The LTC5597HDC is guaranteed functional over the case temperature range -40°C to 125°C . All limits at -40°C and 125°C are guaranteed by 100% production testing.

Note 5: LOG-Linearity Error is the input-referred power measurement error relative to the best fit straight line (output voltage vs input power in dBm) obtained by linear regression at $T_C = 25^\circ\text{C}$. The input power range used for the linear regression is from -37dBm to -5dBm for all frequencies. An offset of 0.5dB is added to the LOG-intercept for all frequencies to center the errors over the full temperature range. See also the Application Section for an explanation of measurement error metrics.

Note 6: Range for which the LOG-Linearity Error is within $\pm 1\text{dB}$.

Note 7: Slope of the best fit straight line obtained by linear regression.

Note 8: Extrapolated input power level (straight line obtained by linear regression) where the voltage at OUT equals 0V .

Note 9: Power range for which LOG-Linearity Error is within $\pm 1\text{dB}$, relative to best fit straight line for CW data (see Note 5).

Note 10: Delay from 50% change in RF_{IN} to 50% change in output voltage.

Note 11: Time required to change voltage at OUT pin from 10% to 90% of final value. Input power stepped from -55dBm to 0dBm .

Note 12: Time required to change voltage at OUT pin from 90% to 10% of initial value. Input power stepped from 0dBm to -55dBm .

Note 13: Time required to change voltage at OUT pin to 90% of final value. Input power 0dBm .

Note 14: Time required to change voltage at OUT pin to 10% of initial value. Input power 0dBm . For higher load impedance the turn-off time will be (much) larger as the OUT interface is high impedance in shutdown mode.

TYPICAL PERFORMANCE CHARACTERISTICS $V_{CC} = 3.3V$, $EN = 3.3V$, $T_C = 25^\circ C$. CW, 50Ω Source at RF_{IN} , $f_{RF} = 2.7GHz$, test circuit is shown in Figure 1.

Output Voltage, Linearity Error vs RF Input Power at 100MHz

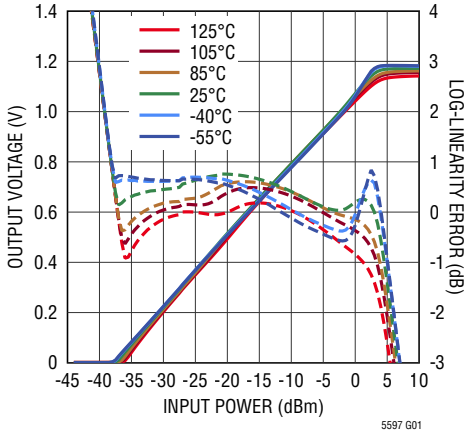

Output Voltage, Linearity Error vs RF Input Power at 500MHz

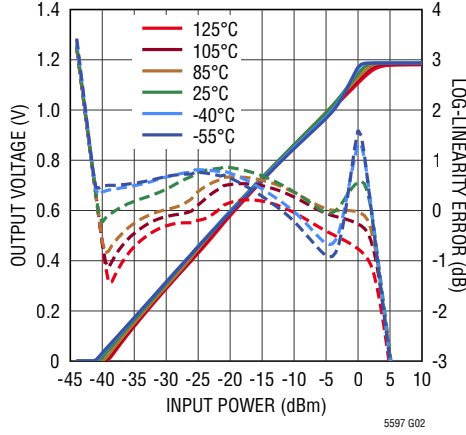

Output Voltage, Linearity Error vs RF Input Power at 1GHz

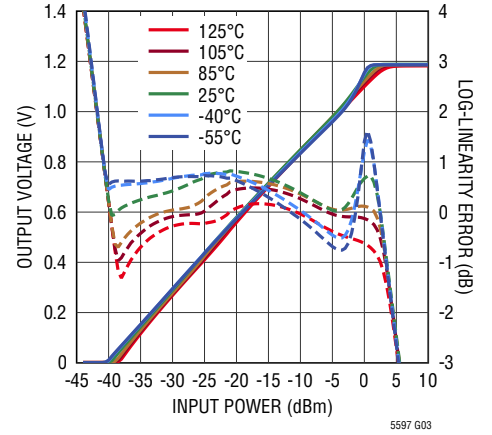

Output Voltage, Linearity Error vs RF Input Power at 2.7GHz

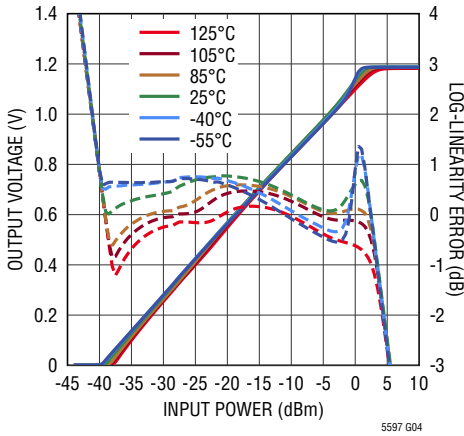

Output Voltage, Linearity Error vs RF Input Power at 5.8GHz

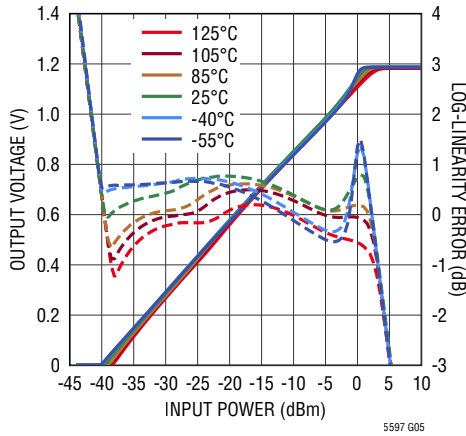

Output Voltage, Linearity Error vs RF Input Power at 10GHz

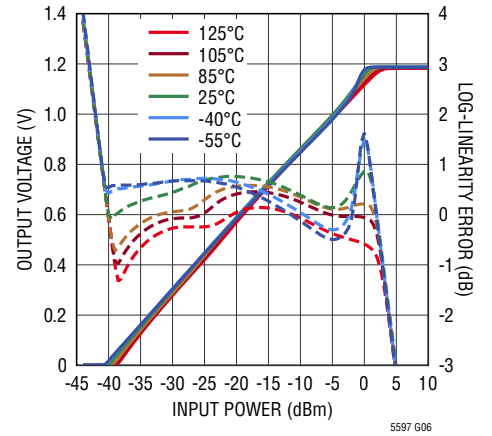

Output Voltage, Linearity Error vs RF Input Power at 15GHz

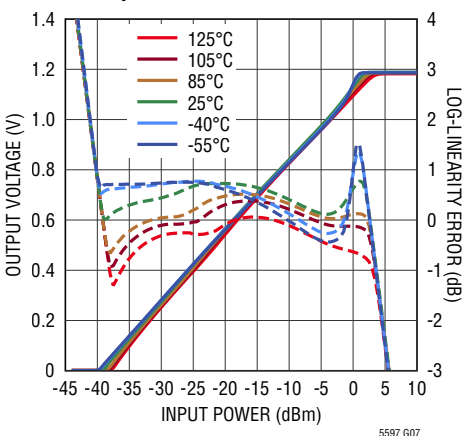

Output Voltage, Linearity Error vs RF Input Power at 18GHz

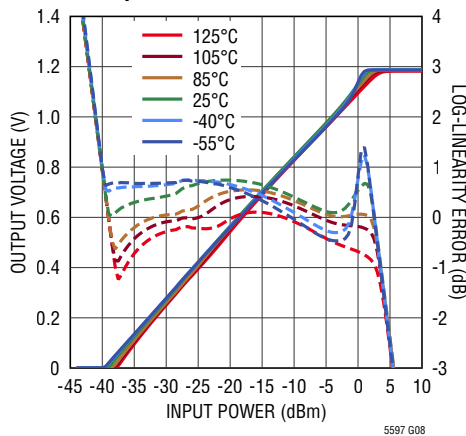

Output Voltage, Linearity Error vs RF Input Power at 24GHz

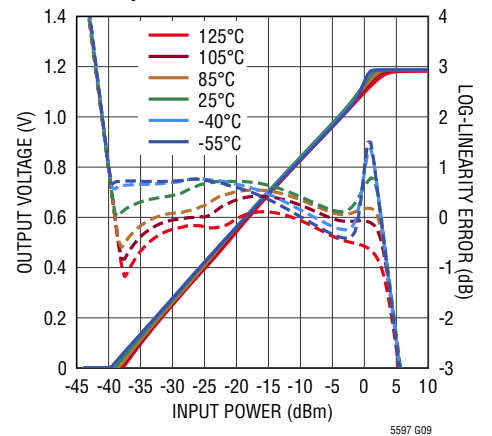

TYPICAL PERFORMANCE CHARACTERISTICS $V_{CC} = 3.3V$, $EN = 3.3V$, $T_C = 25^\circ C$. CW, 50Ω Source at RF_{IN} , $f_{RF} = 2.7GHz$, test circuit is shown in Figure 1.

Output Voltage, Linearity Error vs RF Input Power at 28GHz

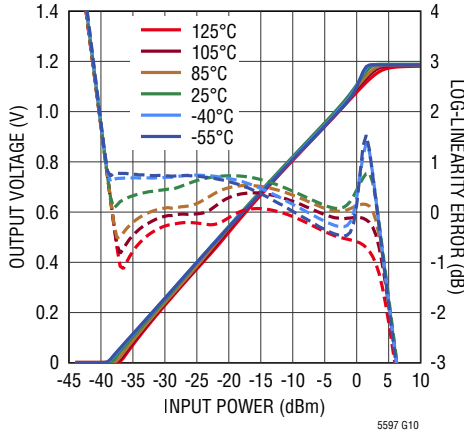

5597 G10

Output Voltage, Linearity Error vs RF Input Power at 30GHz

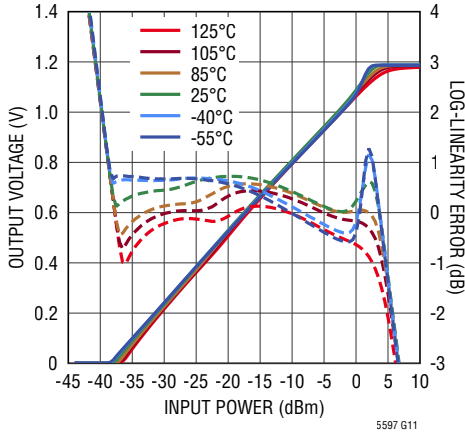

5597 G11

Output Voltage, Linearity Error vs RF Input Power at 39GHz

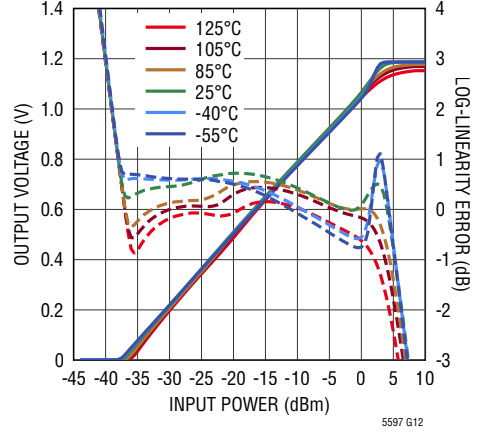

5597 G12

Output Voltage, Linearity Error vs RF Input Power at 42GHz

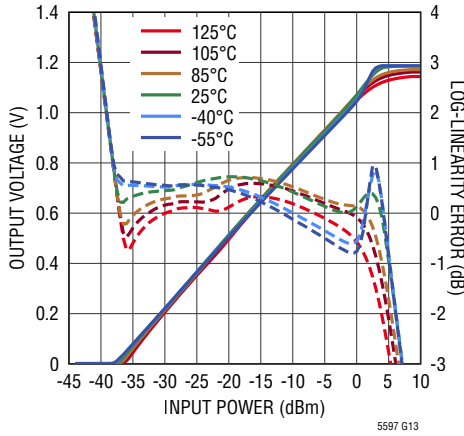

5597 G13

Output Voltage, Linearity Error vs RF Input Power at 50GHz

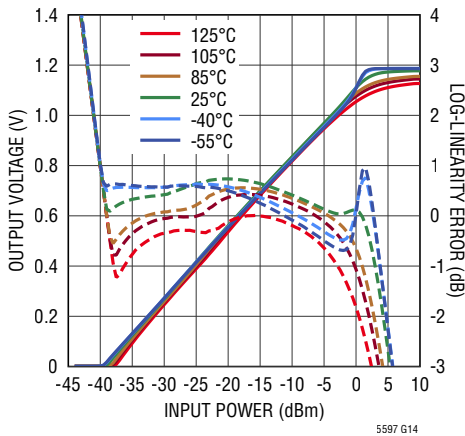

5597 G14

Output Voltage, Linearity Error vs RF Input Power at 52GHz

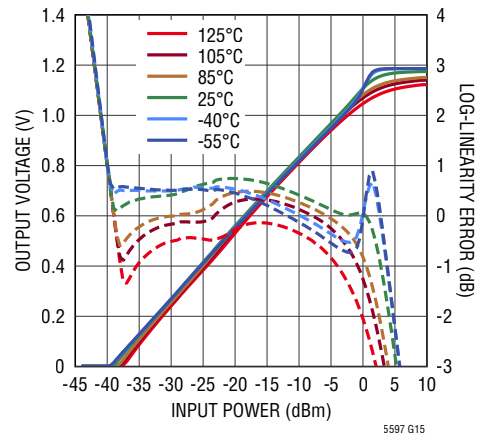

5597 G15

Output Voltage, Linearity Error vs RF Input Power at 60GHz

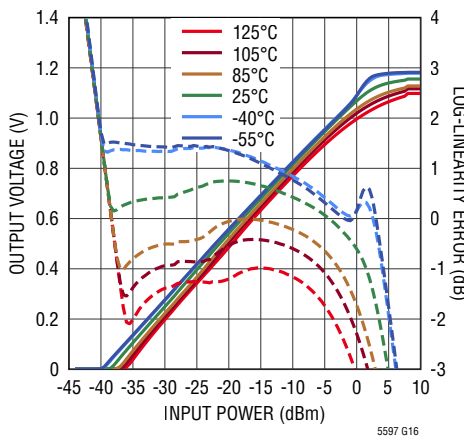

5597 G16

Output Voltage, Linearity Error vs RF Input Power at 67GHz

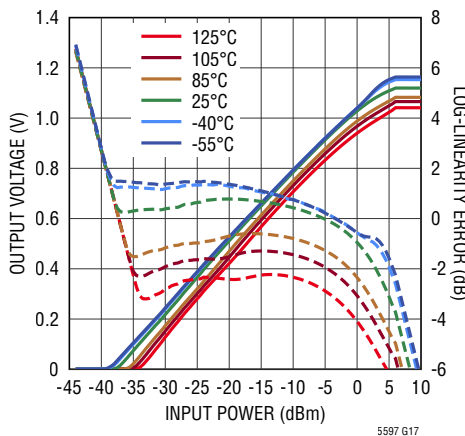

5597 G17

Output Voltage, Linearity Error vs RF Input Power at 70GHz

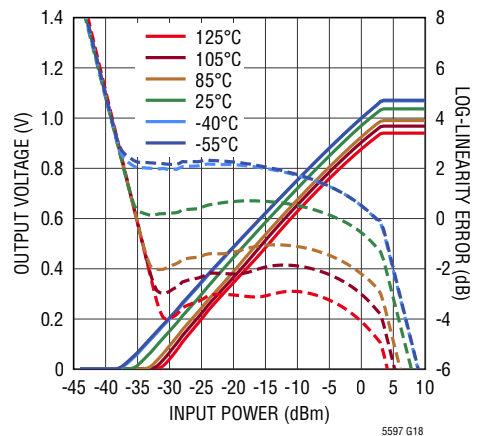

5597 G18

TYPICAL PERFORMANCE CHARACTERISTICS $V_{CC} = 3.3V$, $E_N = 3.3V$, $T_C = 25^\circ C$. CW, 50Ω Source at RF_{IN} , $f_{RF} = 2.7GHz$, test circuit is shown in Figure 1.

Linearity Error Temperature Variation from 25°C at 100MHz

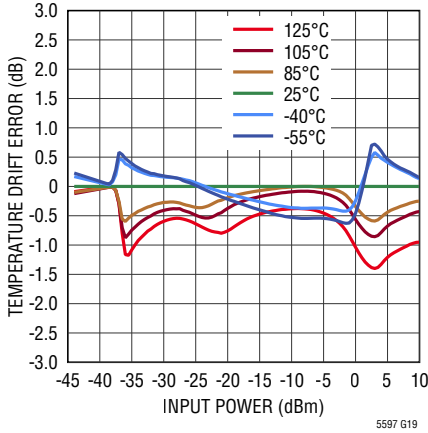

Linearity Error Temperature Variation from 25°C at 500MHz

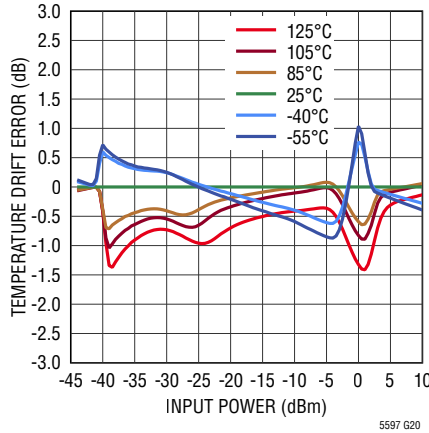

Linearity Error Temperature Variation from 25°C at 1GHz

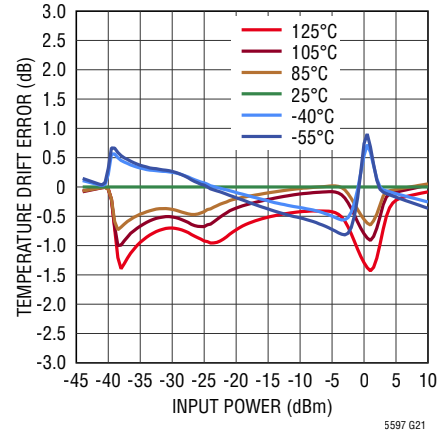

Linearity Error Temperature Variation from 25°C at 2.7GHz

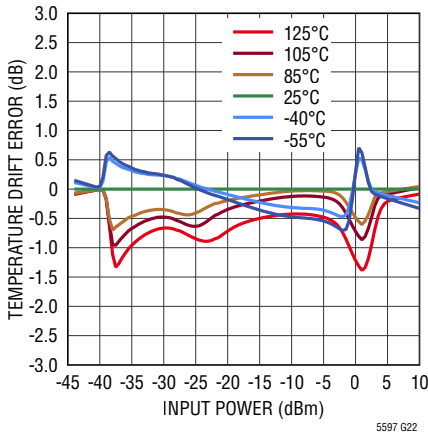

Linearity Error Temperature Variation from 25°C at 5.8GHz

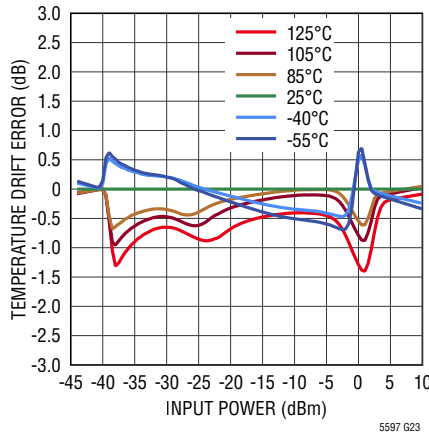

Linearity Error Temperature Variation from 25°C at 10GHz

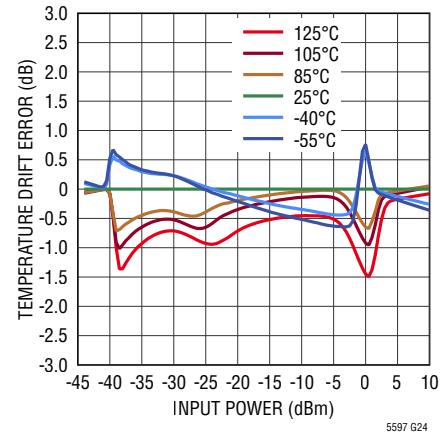

Linearity Error Temperature Variation from 25°C at 15GHz

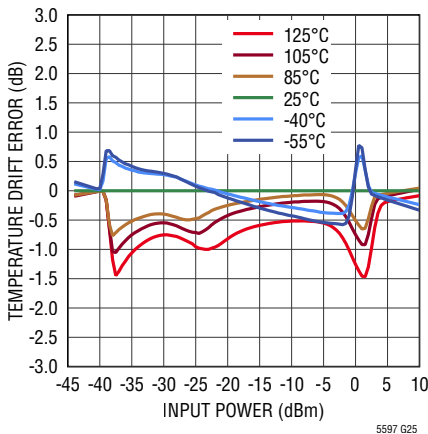

Linearity Error Temperature Variation from 25°C at 18GHz

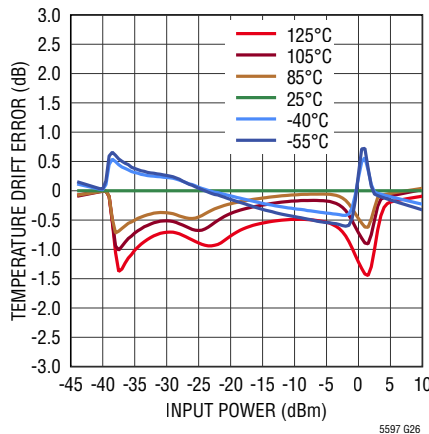

Linearity Error Temperature Variation from 25°C at 24GHz

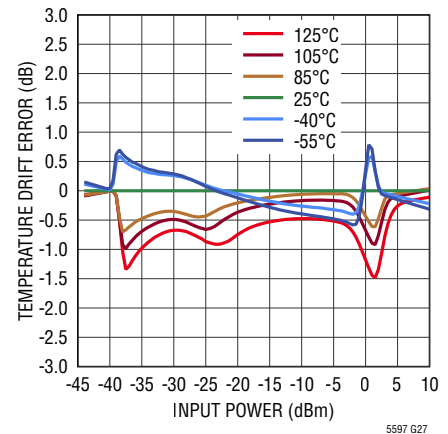

TYPICAL PERFORMANCE CHARACTERISTICS $V_{CC} = 3.3V$, $EN = 3.3V$, $T_C = 25^\circ C$. CW, 50Ω Source at RF_{IN} , $f_{RF} = 2.7GHz$, test circuit is shown in Figure 1.

Linearity Error Temperature Variation from 25°C at 28GHz

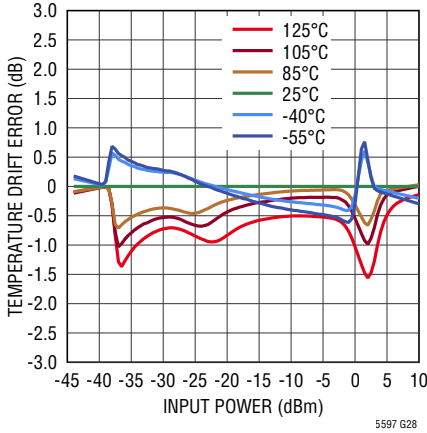

Linearity Error Temperature Variation from 25°C at 30GHz

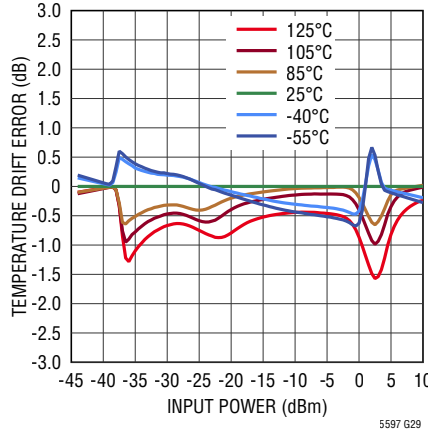

Linearity Error Temperature Variation from 25°C at 39GHz

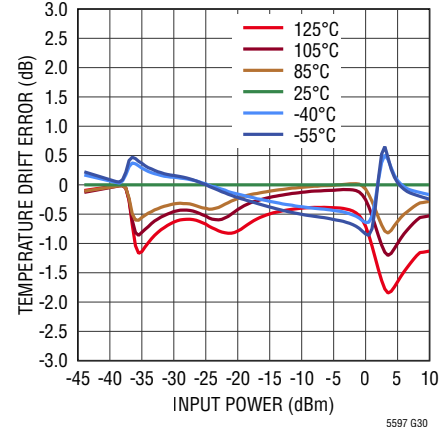

Linearity Error Temperature Variation from 25°C at 42GHz

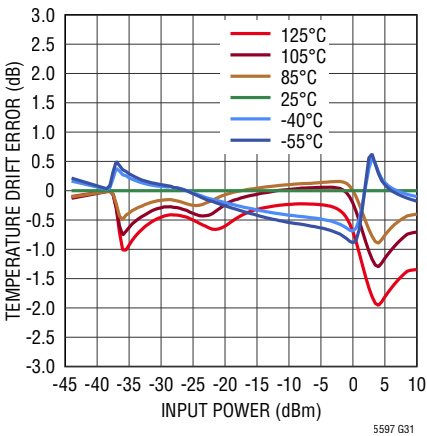

Linearity Error Temperature Variation from 25°C at 50GHz

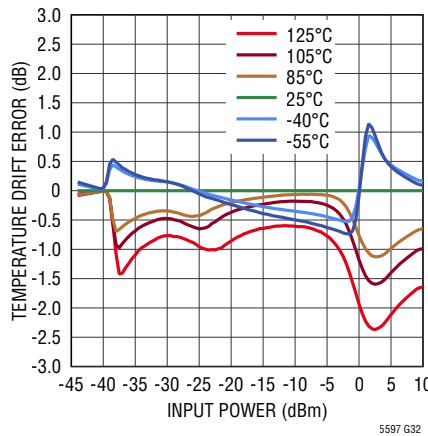

Linearity Error Temperature Variation from 25°C at 52GHz

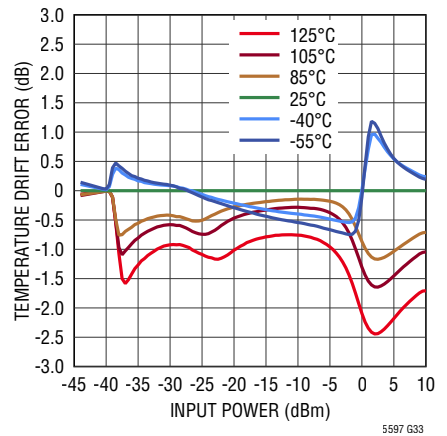

Linearity Error Temperature Variation from 25°C at 60GHz

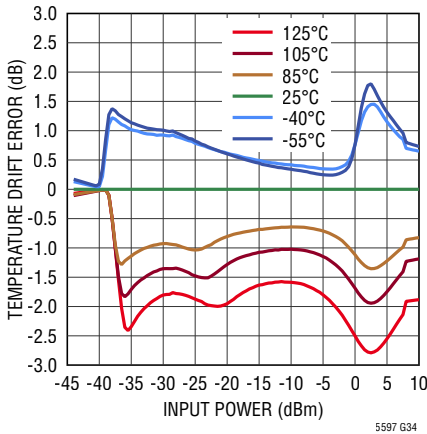

Linearity Error Temperature Variation from 25°C at 67GHz

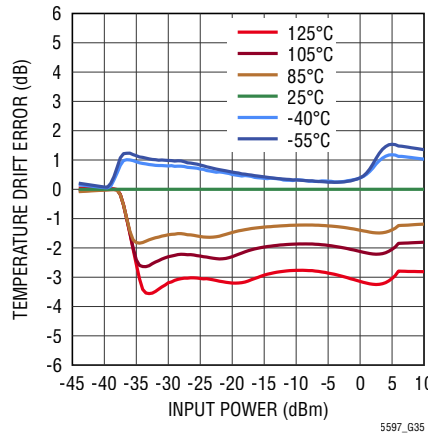

Linearity Error Temperature Variation from 25°C at 70GHz

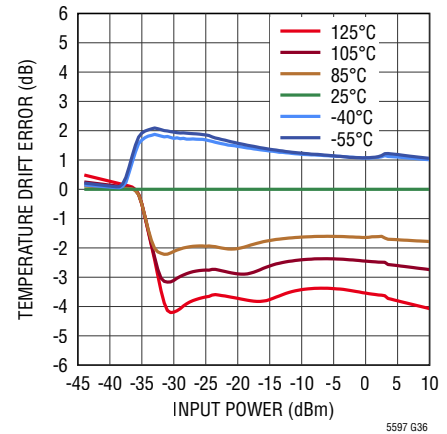

TYPICAL PERFORMANCE CHARACTERISTICS

$V_{CC} = 3.3V$, $EN = 3.3V$, $T_C = 25^\circ C$. CW, 50Ω Source

at RF_{IN} , $f_{RF} = 2.7GHz$, test circuit is shown in Figure 1.

Output Voltage vs RF Input Power for Various Modulation Formats

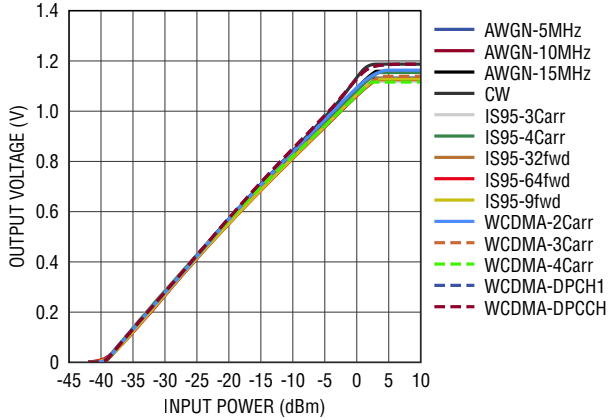

5597 G37

Linearity Error vs RF Input Power for Various Modulation Formats, Regression Using CW Slope and Intercept Values

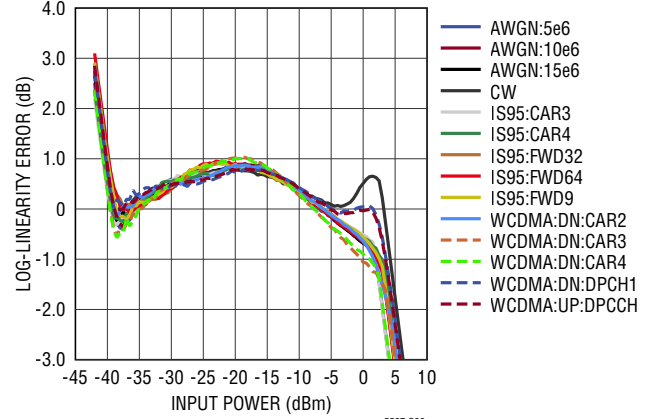

5597 G38

Power Measurement Error Relative to CW for Various Modulation Formats

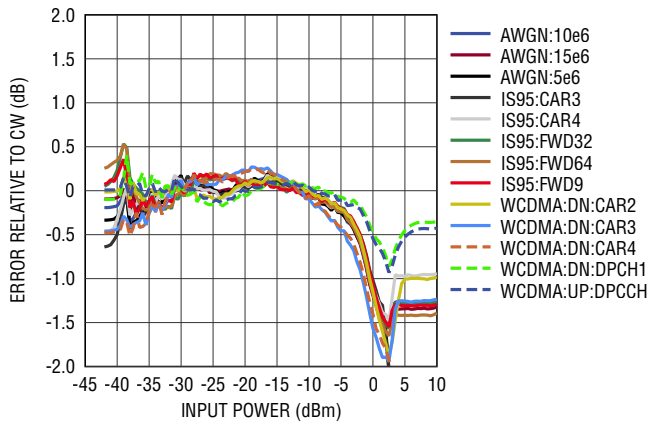

5597 G39

Output Transient Response to RF Input Pulse

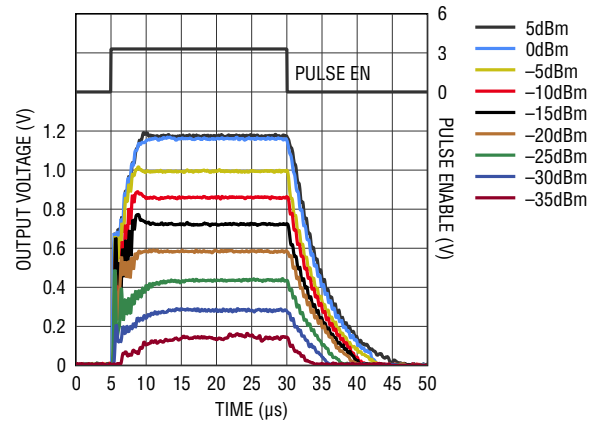

5597 G40

Output Transient Response with CW RF and Enable Pulse

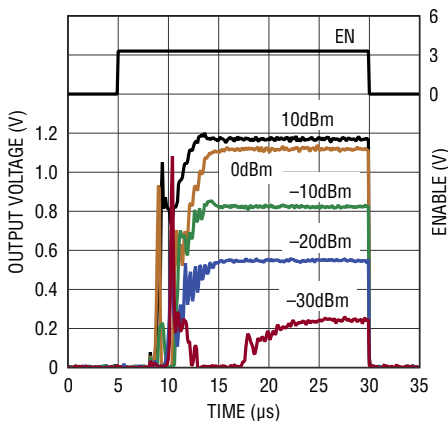

5597 G41

Magnitude S11 vs Frequency

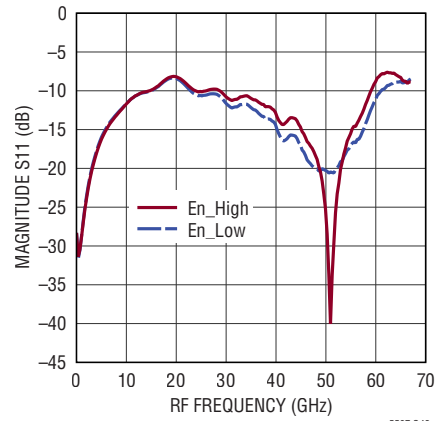

5597 G42

TYPICAL PERFORMANCE CHARACTERISTICS

$V_{CC} = 3.3V$, $E_N = 3.3V$, $T_C = 25^\circ C$. CW, 50Ω Source

at RF_{IN} , $f_{RF} = 2.7GHz$, test circuit is shown in Figure 1.

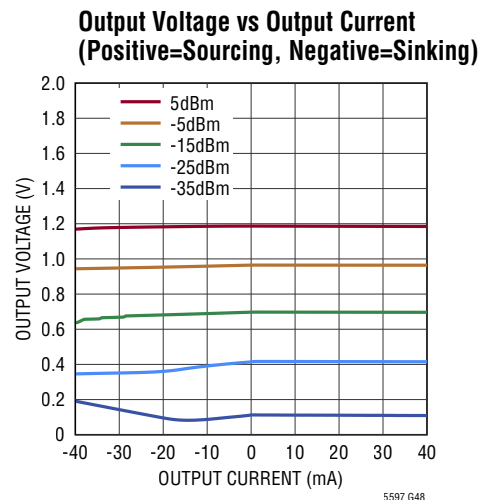
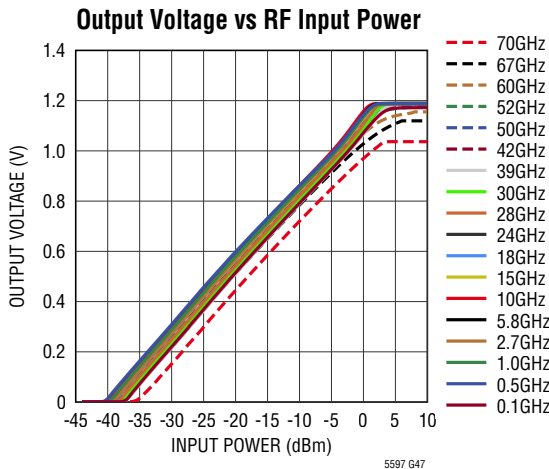
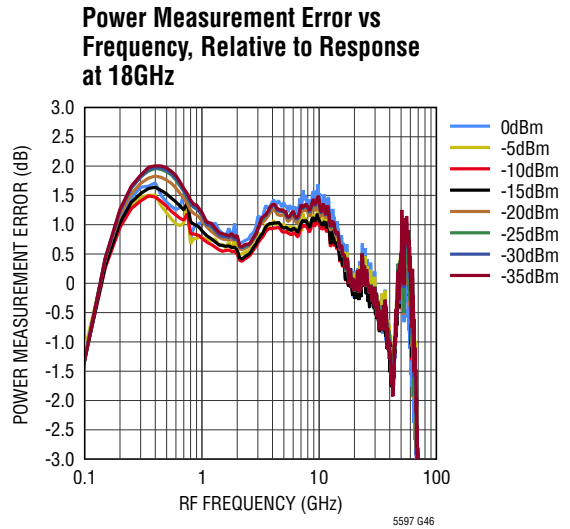
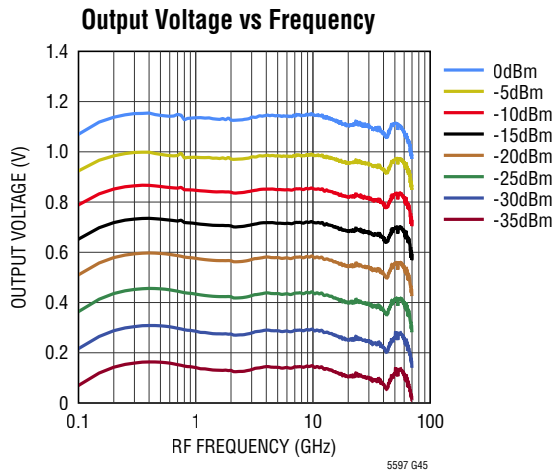
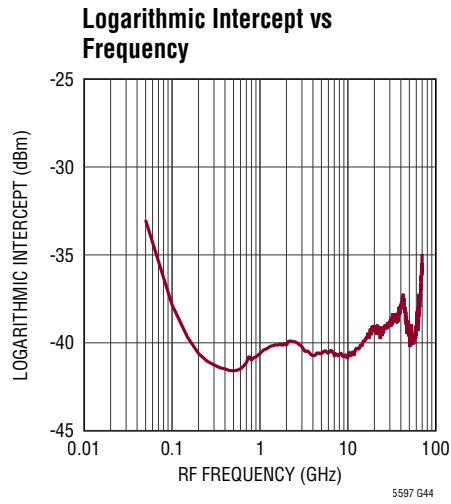
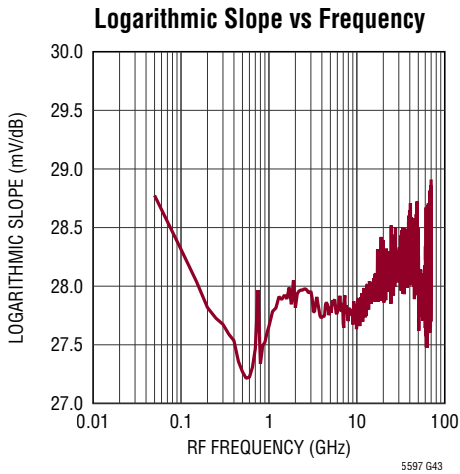

TYPICAL PERFORMANCE CHARACTERISTICS $V_{CC} = 3.3V$, $EN = 3.3V$, $T_C = 25^\circ C$. CW, 50Ω Source at RF_{IN} , $f_{RF} = 2.7GHz$, test circuit is shown in Figure 1.

Detector Error vs Output Load Current (Positive=Sourcing, Negative=Sinking)

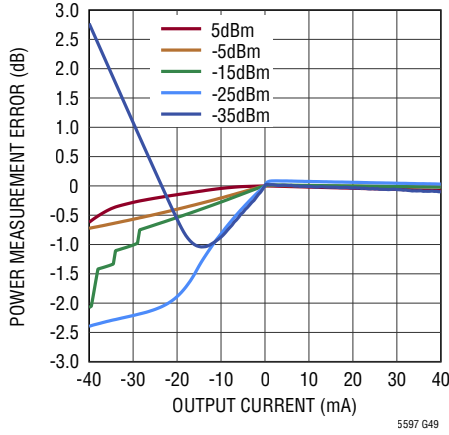

Output Voltage vs Supply Voltage

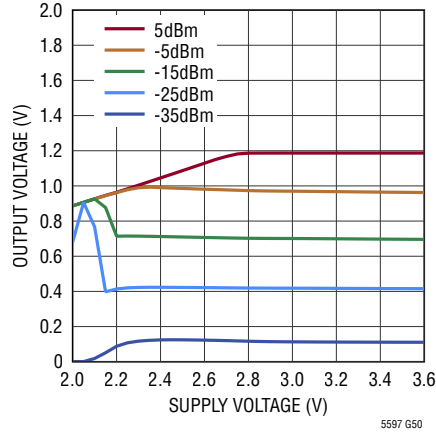

Power Measurement Error vs Supply Voltage, Relative to 3.3V

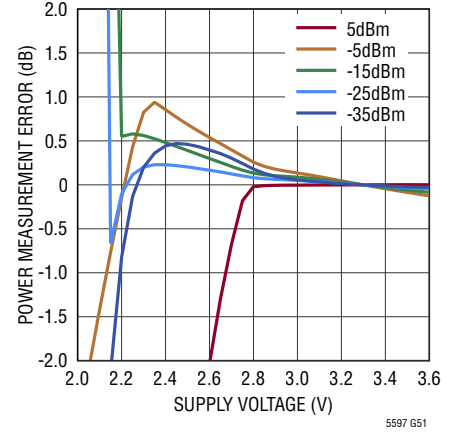

Supply Current vs Supply Voltage

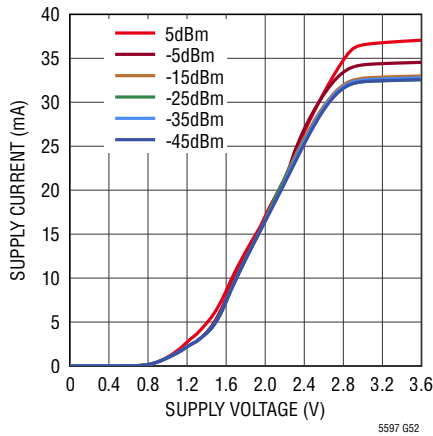

Supply Current vs RF Input Power

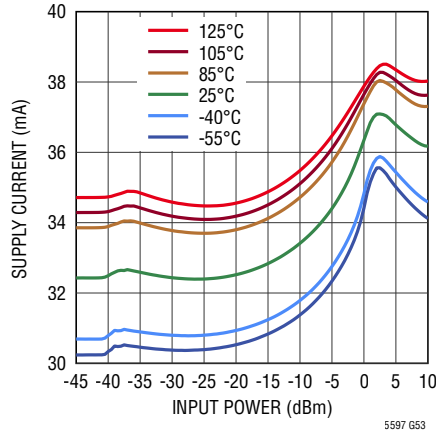

Output Voltage at No RF Input Power Cumulative Distribution

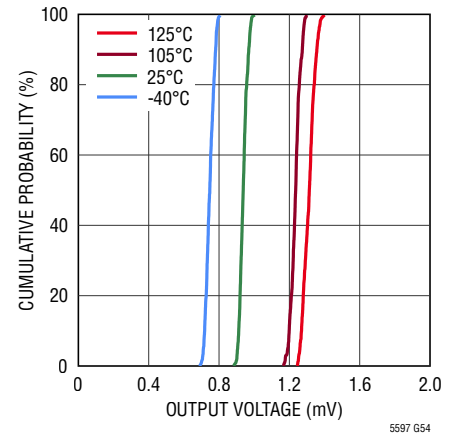

Output Voltage at -35dBm Cumulative Distribution

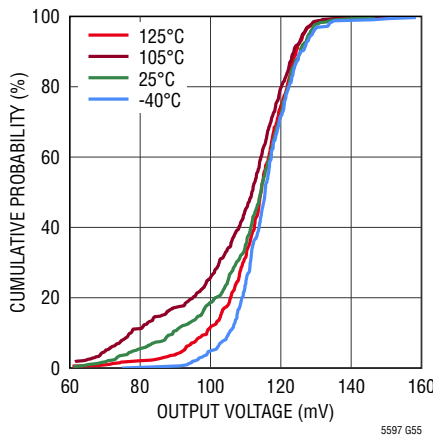

Output Voltage at -30dBm Cumulative Distribution

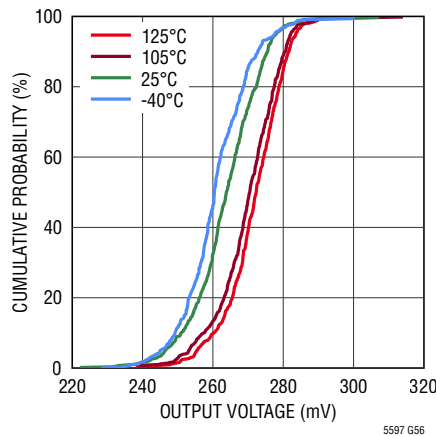

Output Voltage at -25dBm Cumulative Distribution

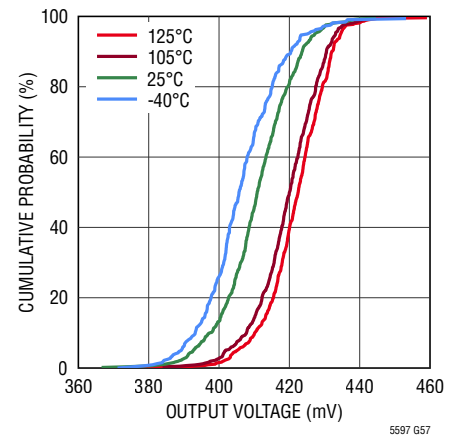

TYPICAL PERFORMANCE CHARACTERISTICS $V_{CC} = 3.3V$, $EN = 3.3V$, $T_C = 25^\circ C$. CW, 50Ω Source at RF_{IN} , $f_{RF} = 2.7GHz$, test circuit is shown in Figure 1.

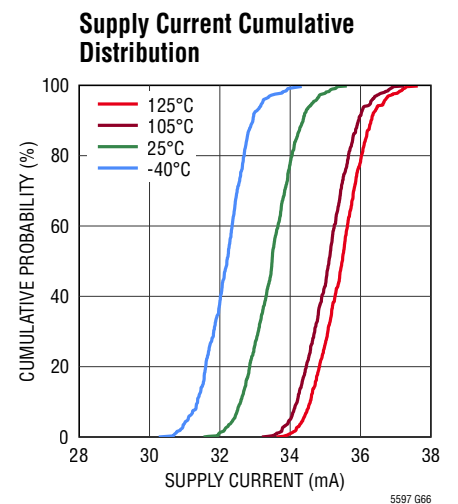
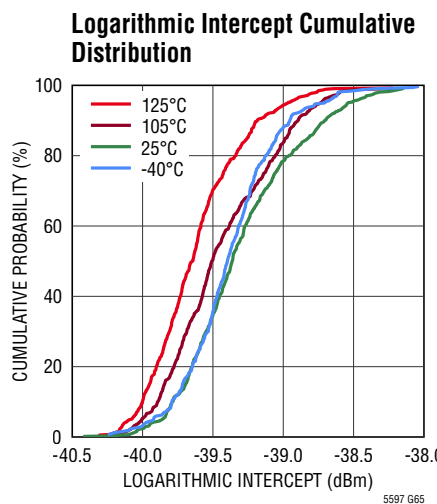
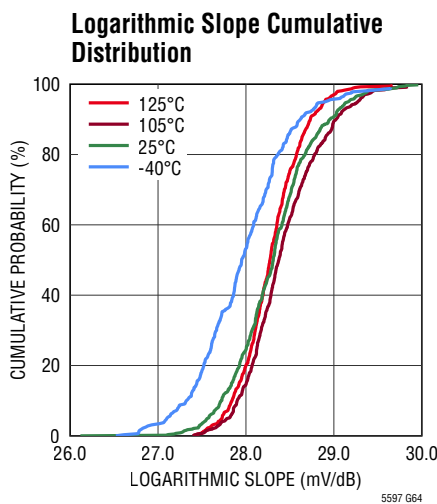
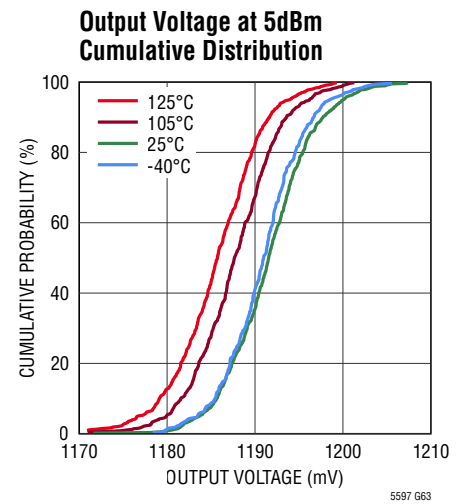
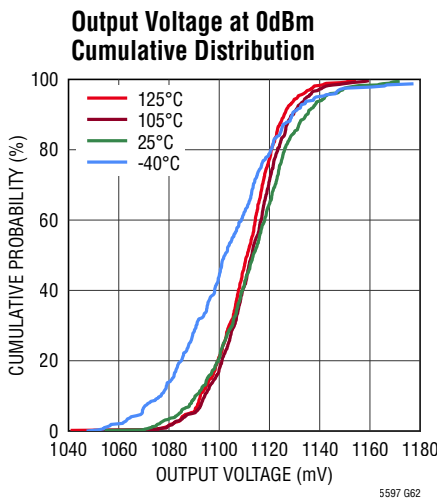
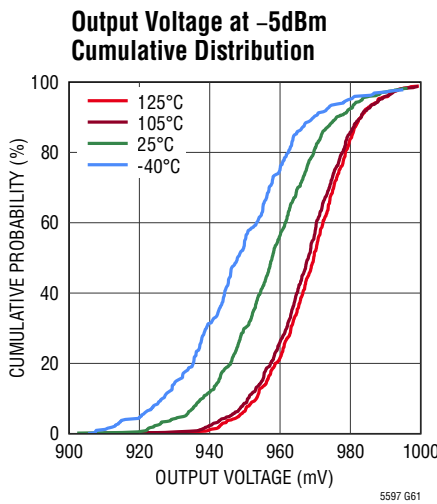
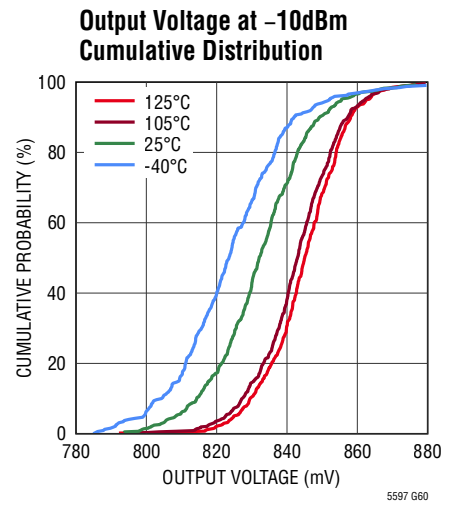
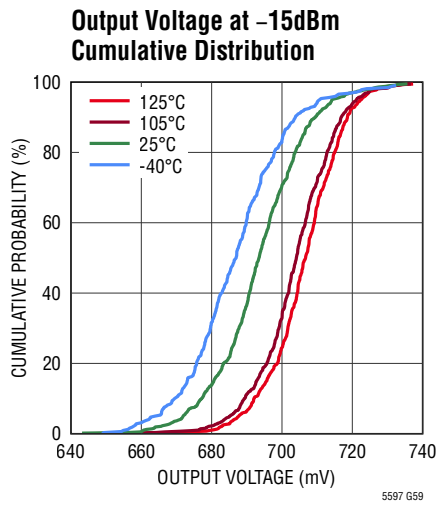
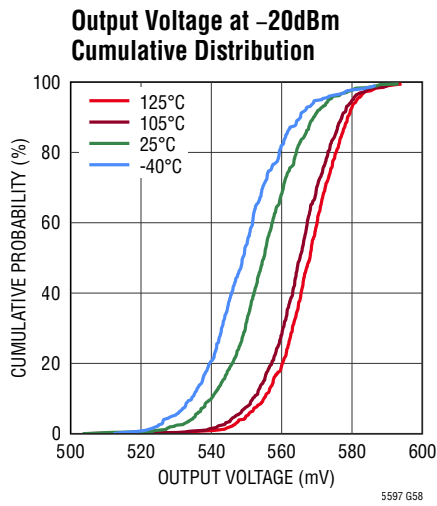

PIN FUNCTIONS

V_{CC} (Pin 1): Power Supply Pin. Typical current consumption is 33mA at room temperature. This pin should be externally bypassed with a 100nF capacitor.

OUT (Pin 2): Detector Output. The DC voltage at this pin varies linearly with the RF input power level in dBm. This output is able to drive a 50Ω load. To avoid permanent damage, do not short to V_{CC} or GND. In shutdown mode (EN = Low), this interface becomes high impedance, to avoid discharge of capacitors in an external ripple filter.

FLTR (Pin 3): An optional capacitor connected between FLTR and OUT (Pin 2) reduces the detector ripple averaging bandwidth. This will also increase the rise and fall times of the detector. To avoid permanent damage to the circuit, the DC voltage at this pin should not exceed 0.4V.

GND (Pins 4, 5, 7, Exposed Pad Pin 9): Circuit Ground. All ground pins are internally connected together. Pins 5 and 7 should be used as RF return ground and connected to the transmission line interfacing to RF_{IN} (pin 6).

RF_{IN} (Pin 6): RF Input. This pin is internally DC-coupled to GND through a 50Ω termination resistor. To avoid damage to the internal circuit, the DC voltage applied to this pin should not exceed 1V. The ground-signal-ground arrangement of pins 5 through 7 support termination of pin 6 by a high frequency transmission line, such as a grounded co-planar waveguide (GCPW). No external decoupling capacitor is necessary as long as the DC voltage on pin 6 is kept below 1V.

EN (Pin 8): Chip Enable. A voltage above 1.1V applied to this pin will bring the device into normal operating mode. A voltage below 0.6V will bring the device into a low power shutdown mode. Do not float this pin.

TEST CIRCUIT

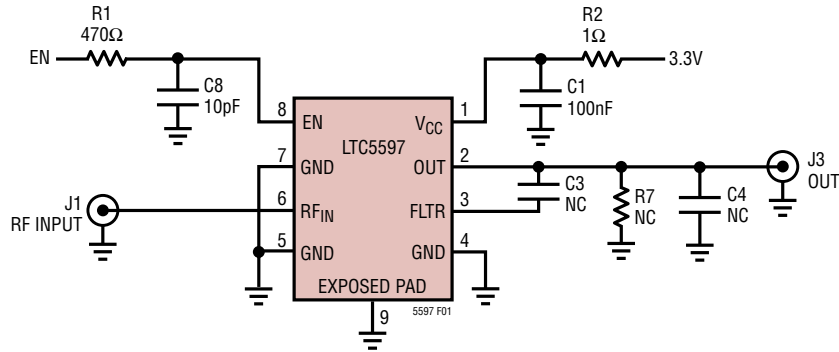

REF DES	VALUE	SIZE	PART NUMBER
C1	100nF	0402	MURATA 935152424610-T3N
C3, C4	NC	0402	
C8	10pF	0402	MURATA GRM155C1H100JA01D
R1	470Ω	0402	VISHAY CRCW0402470RFKED
R2	1Ω	0402	VISHAY CRCW04021R00FNED
R7	NC	0402	
J1	1.85mm JACK to EDGE-LAUNCH, DC-67GHz		SOUTHWEST MICROWAVE 1892-03A-6
J3	SMA 50Ω EDGE-LAUNCH		E.F. JOHNSON, 142-0701-851

Figure 1. Test Schematic Optimized for 100MHz to 70 GHz

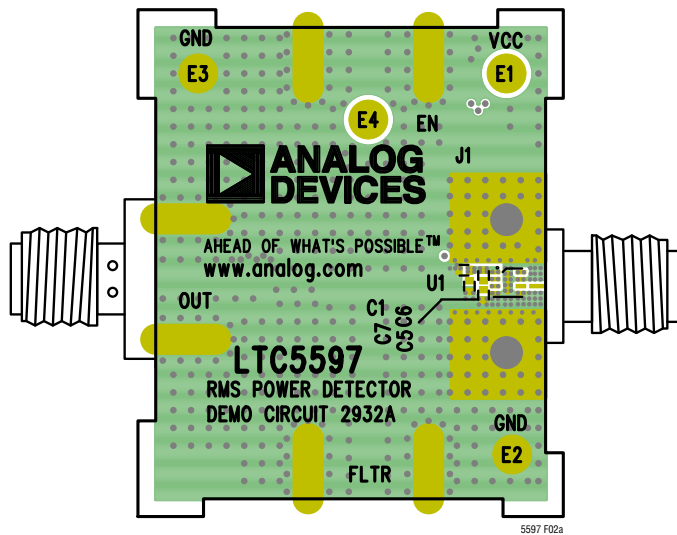

Figure 2a. Top Side of Evaluation Board

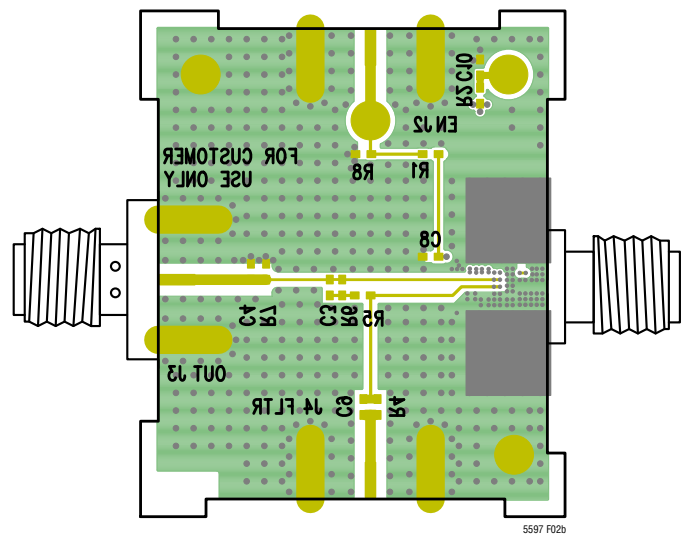

Figure 2b. Bottom Side of Evaluation Board

APPLICATIONS INFORMATION

The LTC5597 is a true RMS RF power detector, capable of measuring an RF signal over the frequency range from 100MHz to 70GHz, independent of input waveforms with different crest factors such as CW, WCDMA, OFDM (LTE and WiFi) signals. Up to 35dB dynamic range is achieved with a very stable output within the full case temperature range.

RF Input

The single-ended RF input is internally matched to 50Ω , both in active mode and the low power shutdown mode. The DC voltage applied to this pin should be kept below 1V, to avoid damage to the internal circuitry, depicted in Figure 3.

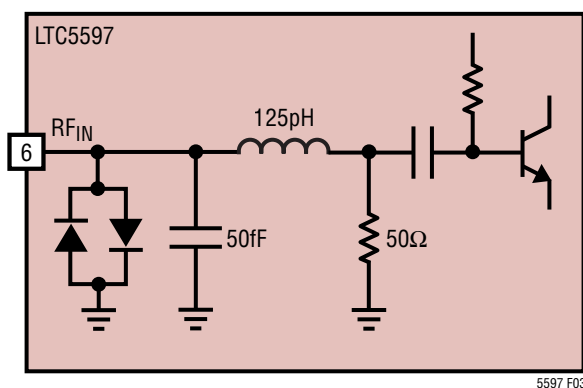

Figure 3. Simplified Schematic of the RF_{IN} Interface

Together with GND Pin 5 and Pin 7, RF_{IN} (Pin 6) forms a ground-signal-ground configuration that can interface directly with a co-planar waveguide on the PCB. The recommended design is depicted in Figure 4.

To minimize reflections at high frequencies, the center strip has been chosen the same width as the RF_{IN} package pin (10mils).

The LTC5597 evaluation board uses a 5mils thick layer of Rogers RO3003 material for the top substrate to achieve low dielectric losses up to 70GHz. The other two substrates on the board are regular FR-4 material. Using this configuration, a 50Ω characteristic impedance is obtained for a 9mils gap width between the center strip and the two ground return conductors. Vias connecting the top ground conductors with the second metal ground plane should be placed along the edge of the GCPW top ground

conductors. Via dimensions should be kept as small as possible. The evaluation board uses vias with a diameter of 6mils or 8mils including the metal edge ring (donut).

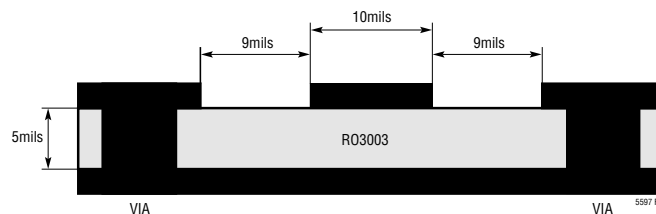

Figure 4. Grounded Co-Planar Waveguide (GCPW) to Interface RF_{IN} FLTR Interface (Pin 3):

This pin enables additional suppression of high frequency ripple in the detector output signal, at the expense of a slower detector response (longer rise time, fall time and propagation delay). As depicted in Figure 1, an external capacitor C3 connected between FLTR and OUT enlarges the amount of feedback capacitance across the output amplifier, and reduces the output filter bandwidth without affecting the current drive capability of the LTC5597. Suitable capacitance values are in the range from 10pF up to 1nF, but the total of feedback and load capacitance (from OUT to signal ground) should not exceed 1nF. Larger capacitance values may result in instability of the output driver.

To avoid permanent damage to the chip, the DC voltage at the FLTR pin should not exceed 0.4V. Similarly, it is not recommended to supply a DC bias current to this pin in excess of about 100μA.

OUT Interface (Pin 2):

The OUT interface, depicted in Figure 5, is a class-AB CMOS output stage that can source and sink over 20mA of load current.

It is able to drive a load resistance of 50Ω (or higher) over the full output voltage range. Short-circuiting the OUT interface should be avoided though, as this can lead to permanent damage of the device. The output driver is stable for capacitive loads up to at least 1nF. This includes any external feedback capacitance between OUT and FLTR, which is essentially experienced as a load by the driver amplifier.

APPLICATIONS INFORMATION

Additional ripple filtering using larger capacitances can be achieved by connecting a series-RC low pass filter to OUT. This however reduces the current drive capability of the output signal, since the filter resistor is placed in series with OUT.

In general, the rise time of the LTC5597 is much shorter than the fall time. An external feedback capacitor between FLTR and OUT increases both rise and fall time, while an RC filter connected in series with OUT will primarily increase the rise time (as long as the time constant is smaller than the fall time).

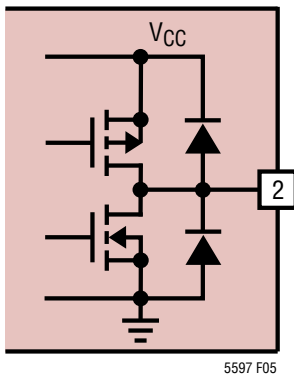

Figure 5. Simplified Schematic of the OUT Interface

The OUT interface becomes high impedance when the device is put into shutdown mode (EN = Low). This prevents discharge of capacitors in a ripple filter connected to the OUT interface. The fall time of the voltage at the OUT interface when the device is turned off (high to low transition of EN) is therefore dependent on the load impedance. Figure 6 shows the output voltage transient when the device is turned off for a 1M Ω load impedance and a 50 Ω load impedance.

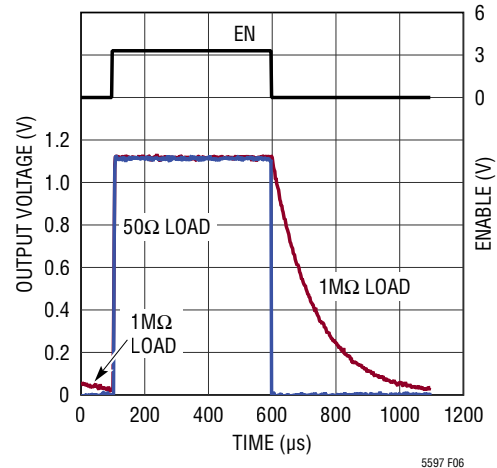

Figure 6. Output Voltage Turn-Off Transient for 1M Ω ||11pF and 50 Ω Load Impedance. Input Power 0dBm, Input Frequency 2700MHz.

Enable Interface (Pin 8)

A simplified schematic of the EN pin interface is shown in Figure 7. The CMOS logic brings the device in its active operating mode for input voltages above 1.1V. Input voltages below 0.6V bring it into a low power shutdown mode. The voltage applied to the EN pin should never exceed V_{CC} by more than 0.3V, and never decrease below GND by 0.3V. Otherwise, permanent damage to the ESD diodes may occur. Placing an external resistor of at least several hundred Ω in series with the EN interface is an effective way to avoid such damage, by limiting the current flowing through the ESD diodes (see Figure 1).

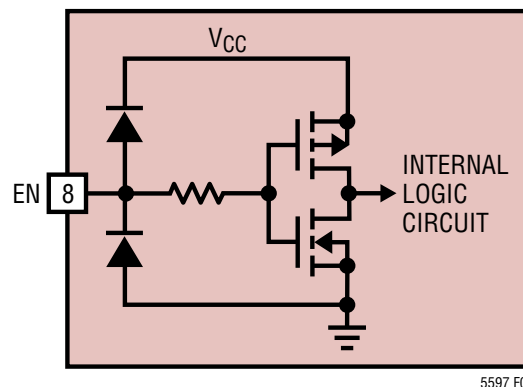

Figure 7. Simplified Schematic of the EN Interface

APPLICATIONS INFORMATION

Supply Voltage Ramping

Fast ramping of the supply voltage can cause a current glitch in the internal ESD protection circuits. Depending on the supply inductance, this could result in a supply voltage overshooting at the initial transient that exceeds the maximum rating. A supply voltage ramp time of greater than 1ms is recommended. In case this voltage ramp time is not controllable, a small series resistor should be inserted in between the V_{CC} pin and the supply voltage source to mitigate the problem and self protect the IC. The 1Ω resistor R2 and capacitor C1 shown in Figure 1 serve this purpose.

High Accuracy Power Measurement

The power measurement accuracy achieved using a power detector is not only determined by the performance of the power detector device itself, but also by the approach/methods used to interpret the DC power detector output signal. This can be understood by considering Figure 8.

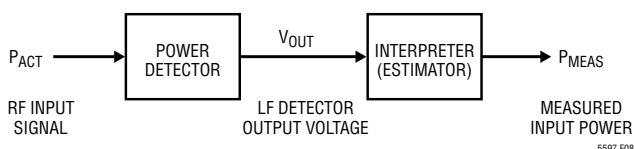

Figure 8. Power Measurement Concept

Systems for accurate power level measurements on RF signals can conceptually be thought to consist of two elements:

- A high accuracy power detector (like the LTC5597), converting the power level of an RF signal into a DC voltage or current;
- An interpreter (also called an estimator), translating the DC output voltage or current of the power detector back to a power level.

In Figure 8, P_{MEAS} represents the power level measured by the system, i.e. the power level the system thinks is present at its input, while P_{ACT} represents the actual power level present at the detector input. The power measurement error thus equals the difference:

$$P_{ERR} = P_{MEAS} - P_{ACT}.$$

The more the interpreter knows about the operating conditions and transfer of the detector, the smaller the measurement error that can be achieved. For example, the interpreter may assume that the detector response is perfectly linear in dB, such that the relationship between input power and output voltage is a straight line:

$$V_{OUT} = SLOPE \cdot (P_{MEAS} - P_{INTERCEPT})$$

This results in a power measurement error equal to:

$$LOG\text{-Linearity Error} = V_{OUT}/SLOPE + P_{INTERCEPT} - P_{ACT}$$

The parameters SLOPE and $P_{INTERCEPT}$, the LOG-slope and LOG-intercept, are best obtained from the actual detector response using linear regression over a suitable power range (where the detector response is close to linear). Better accuracy/smaller errors are obtained if SLOPE and $P_{INTERCEPT}$ are determined for:

- Each detector device individually
- Each operating temperature
- Each operating frequency

To achieve the best accuracy, it is recommended to determine SLOPE and $P_{INTERCEPT}$ for each individual unit, requiring a 2-point factory calibration. When temperature drift effects are to be included, SLOPE and $P_{INTERCEPT}$ need to be determined at different operating temperatures and the system needs to incorporate a temperature sensor to determine which parameter values to use for the current operating temperature.

APPLICATIONS INFORMATION

The LOG-linearity error curves in the Typical Performance Characteristics section were obtained using linear regression, applied to the response of the individual detector devices at $T = 25^{\circ}\text{C}$. For all frequencies, the input power range from -37dBm to -5dBm was used. The resulting LOG-linearity error tends to have larger negative values than positive values. To center the error curves within the $\pm 1\text{dB}$ range, an additional 0.5dB was added to the $P_{\text{INTERCEPT}}$ parameter. This slightly increases the measurement error at $T = 25^{\circ}\text{C}$, but results in a smaller error over the full temperature range. The calculated LOG-slope and LOG-intercept numbers are displayed in the tables on page 4 and 5.

A better measurement accuracy is achieved if the interpreter uses the actual detector response at $T = 25^{\circ}\text{C}$ as model for the detector, instead of the perfect linear-in-dB response described above. The resulting measurement error, the temperature drift error, equals:

$$\text{Temperature Drift Error} = [V_{\text{OUT}}(T) - V_{\text{OUT}}(25^{\circ}\text{C})] / \text{SLOPE}$$

A system that achieves this measurement error should store the full output voltage vs input power response of the detector with suitable resolution. The error curves displayed on page 9 and 10 represent the achieved power measurement accuracy using this configuration.

PACKAGE DESCRIPTION

DC Package 8-Lead Plastic DFN (2mm × 2mm), Flip Chip (Reference LTC DWG # 05-08-1957 Rev A)

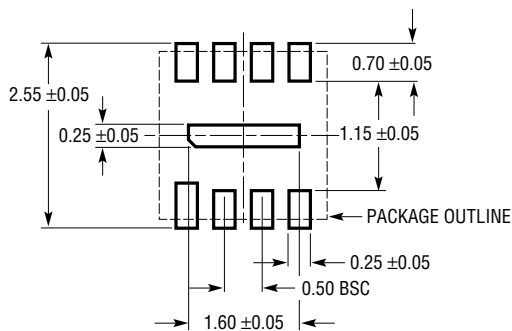

RECOMMENDED SOLDER PAD PITCH AND DIMENSIONS
APPLY SOLDER MASK TO AREAS THAT ARE NOT SOLDERED

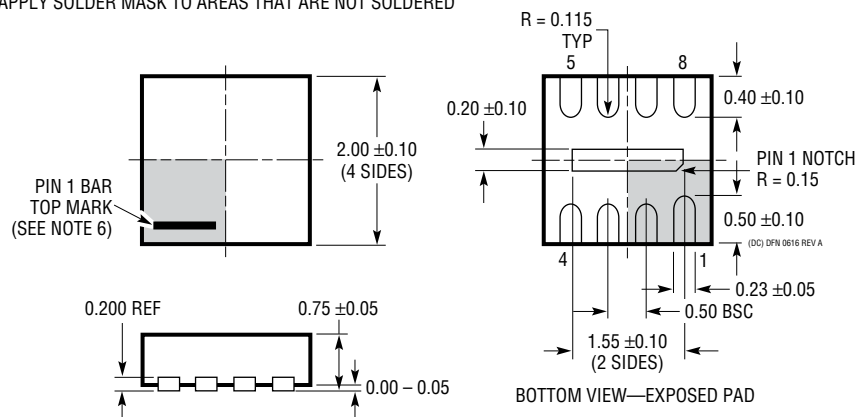

NOTE:

1. DRAWING IS NOT A JEDEC PACKAGE OUTLINE
2. DRAWING NOT TO SCALE
3. ALL DIMENSIONS ARE IN MILLIMETERS
4. DIMENSIONS OF EXPOSED PAD ON BOTTOM OF PACKAGE DO NOT INCLUDE MOLD FLASH. MOLD FLASH, IF PRESENT, SHALL NOT EXCEED 0.15mm ON ANY SIDE
5. EXPOSED PAD SHALL BE SOLDER PLATED
6. SHADED AREA IS ONLY A REFERENCE FOR PIN 1 LOCATION ON THE TOP AND BOTTOM OF PACKAGE

TYPICAL APPLICATION

100MHz to 70GHz Power Measurement

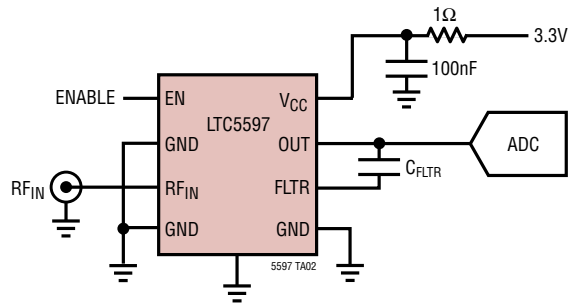

RELATED PARTS

PART NUMBER	DESCRIPTION	COMMENTS
RF Power Detectors		
ADL6012	2 GHz to 67 GHz, 500 MHz BW Envelope Detector	0.5 to 1ns propagation delay, 0.6/1.3ns rise/fall time, 40dB dynamic range up to 43.5GHz.
LTC5596	100MHz to 40GHz Linear-in-dB RMS Power Detector with 35dB Dynamic Range	±1dB Flat Response from 200MHz to 30GHz, < ±1dB Error, 29mV/dB Logarithmic Slope.
ADL6010	Fast Responding, 45 dB Range, 0.5 GHz to 43.5 GHz Envelope Detector	Schottky detector with accurate linearization, 40MHz envelope bandwidth, 4ns output rise time.
HMC1094	50 dB, Logarithmic Detector, 1-23 GHz	Fast rise/fall time: 12ns/65ns, 3.3V.
HMC7447	E-Band Detector, 71-86 GHz	24dB Dynamic Range, -0.5dBm to +23.5dBm, Insertion loss 0.45dB.
Mixers		
ADMV1017/1018	24 GHz to 29.5 GHz, 5G Up/Down converter	Baseband IQ or Image Reject. LO doubler and quadrupler modes. 1.5GHz RF bandwidth.