

Precision 600MHz to 7GHz, RF Detector with Adjustable Gain and 12MHz Baseband Bandwidth

FEATURES

- Temperature Compensated Internal Schottky Diode RF Detector
- Wide Input Frequency Range: 600MHz to 7GHz*
- Wide Input Power Range: -32dBm to 10dBm
- External Gain Control
- Precision V_{OUT} Offset Control
- Low Starting Voltage: 200mV for Gain = 2
- Wide V_{CC} Range of 2.7V to 5.5V
- Low Operating Current: 2mA
- Available in a Low Profile (1mm) SOT-23 Package

APPLICATIONS

- 802.11a, 802.11b, 802.11g, 802.15, 802.16
- Multimode Mobile Phone Products
- Optical Data Links
- Wireless Data Modems
- Wireless and Cable Infrastructure
- RF Power Alarm
- Envelope Detector

DESCRIPTION

The LTC[®]5535 is an RF power detector for RF applications operating in the 600MHz to 7GHz range. A temperature compensated Schottky diode peak detector and output amplifier are combined in a small ThinSOT[™] package. The supply voltage range is optimized for operation from a single cell lithium-ion or three cell NiMH battery.

The RF input voltage is peak detected using an on-chip Schottky diode. The detected voltage is buffered and supplied to the V_{OUT} pin.

The LTC5535 output amplifier gain is set via external resistors. The initial starting voltage of 200mV can be precisely adjusted using the V_{OS} pin.

The LTC5535 operates with input power levels from -32dBm to 10dBm. The 12MHz baseband bandwidth is much higher than that of previous Schottky detector products.

LT, LTC and LT are registered trademarks of Linear Technology Corporation. ThinSOT is a trademark of Linear Technology Corporation.

*Higher frequency operation is achievable with reduced performance. Consult factory for more information.

TYPICAL APPLICATION

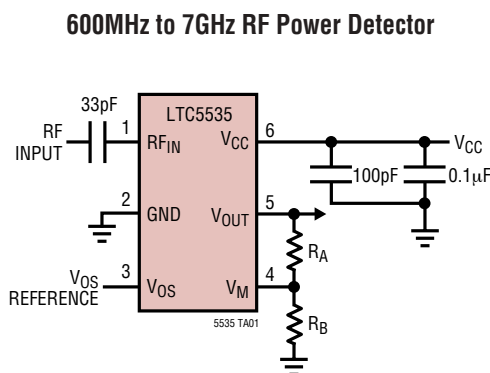

Output Voltage vs RF Input Power

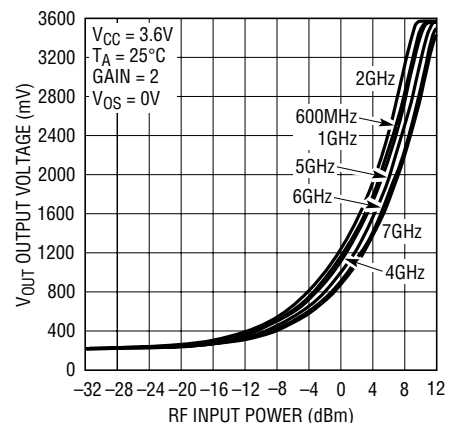

5535 TA02

ABSOLUTE MAXIMUM RATINGS

(Note 1)

V_{CC} , V_{OUT} , V_M , V_{OS}	-0.3V to 6V
RF_{IN} Voltage	($V_{CC} \pm 1.5V$) to 6.5V
RF_{IN} Power (RMS)	12dBm
I_{VOUT}	25mA
Operating Temperature Range (Note 2) ..	-40°C to 85°C
Maximum Junction Temperature	125°C
Storage Temperature Range	-65°C to 150°C
Lead Temperature (Soldering, 10 sec).....	300°C

PACKAGE/ORDER INFORMATION

	ORDER PART NUMBER
	LTC5535ES6
	S6 PART MARKING
	LBHK

Consult LTC Marketing for parts specified with wider operating temperature ranges.

ELECTRICAL CHARACTERISTICS

The ● denotes the specifications which apply over the full operating temperature range, otherwise specifications are at $T_A = 25^\circ\text{C}$. $V_{CC} = 3.6\text{V}$, RF Input Signal is Off, $R_A = R_B = 500\Omega$, $V_{OS} = 0\text{V}$ unless otherwise noted.

PARAMETER	CONDITIONS	MIN	TYP	MAX	UNITS
V_{CC} Operating Voltage		● 2.7		5.5	V
I_{VCC} Operating Current	$I_{VOUT} = 0\text{mA}$	●	2	3.5	mA
V_{OUT} V_{OL} (No RF Input)		● 150	180 to 220	250	mV
V_{OUT} Output Current	$V_{OUT} = 1.75\text{V}$, $V_{CC} = 2.7\text{V}$ to 5.5V, $\Delta V_{OUT} < 10\text{mV}$	10	20		mA
V_{OUT} Bandwidth	$C_{LOAD} = 33\text{pF}$, $R_{LOAD} = 2\text{k}$, $P_{IN} = -10\text{dBm}$ (Note 4)		12		MHz
V_{OUT} Load Capacitance	(Note 6)	●		33	pF
V_{OUT} Slew Rate	$V_{RFIN} = 1\text{V}$ Step, $C_{LOAD} = 33\text{pF}$ (Note 3)		50		V/ μs
V_{OUT} Noise	$V_{CC} = 3\text{V}$, Noise BW = 1.5MHz, 50 Ω RF Input Termination, 50 Ω AC Output Termination		1		mV _{p-p}
V_{OS} Voltage Range		● 0		1	V
V_{OS} Input Current	$V_{OS} = 1\text{V}$	● -0.5		0.5	μA
V_M Voltage Range		● 0		$V_{CC} - 1.8$	V
V_M Input Current	$V_M = 3.6\text{V}$	● -0.5		0.5	μA
RF_{IN} Input Frequency Range			600 to 7000		MHz
RF_{IN} Input Power Range	RF Frequency = 300MHz to 7GHz (Note 5, 6) $V_{CC} = 2.7\text{V}$ to 6V		-32 to 10		dBm
RF_{IN} AC Input Resistance	$F = 1000\text{MHz}$, $P_{in} = -25\text{dBm}$		220		Ω
RF_{IN} Input Shunt Capacitance	$F = 1000\text{MHz}$, $P_{in} = -25\text{dBm}$		0.65		pF

Note 1: Absolute Maximum Ratings are those values beyond which the life of a device may be impaired.

Note 2: Specifications over the -40°C to 85°C operating temperature range are assured by design, characterization and correlation with statistical process controls.

Note 3: The rise time at V_{OUT} is measured between 1.3V and 2.3V.

Note 4: See Table 1 in Applications Information section.

Note 5: RF performance is tested at 1800MHz

Note 6: Guaranteed by design.

TYPICAL PERFORMANCE CHARACTERISTICS ($R_{LOAD} = 1k = R_A + R_B$)

Output Voltage vs Supply Voltage

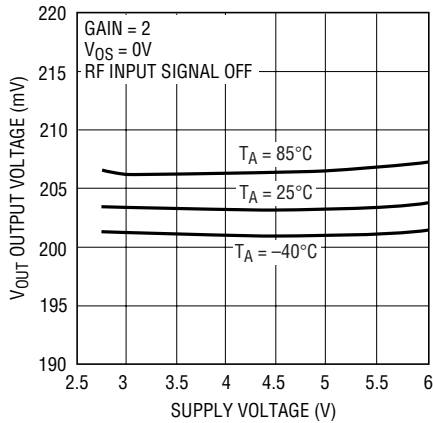

5535 G01

Supply Current vs Supply Voltage

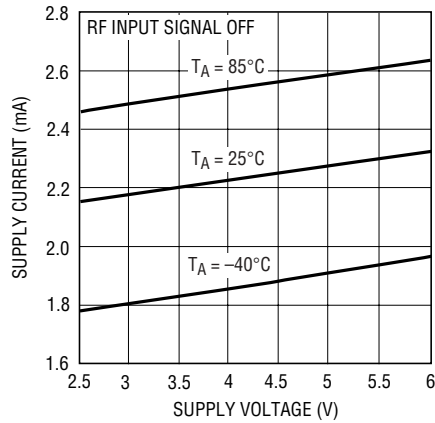

5535 G02

Typical Detector Characteristics, 600MHz, Gain = 2, $V_{OS} = 0V$

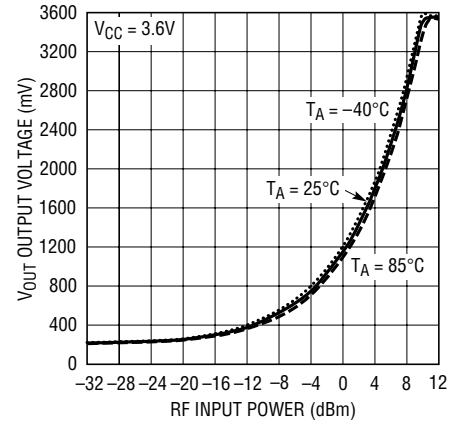

5535 G03

Typical Detector Characteristics, 1000MHz, Gain = 2, $V_{OS} = 0V$

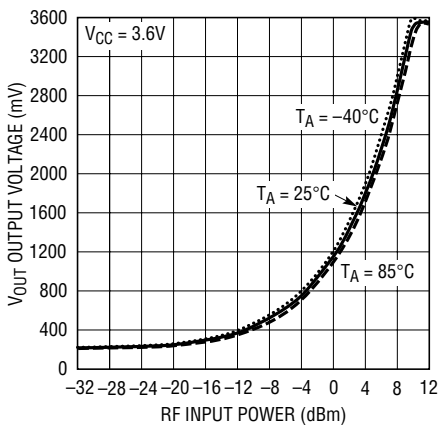

5535 G04

Typical Detector Characteristics, 2000MHz, Gain = 2, $V_{OS} = 0V$

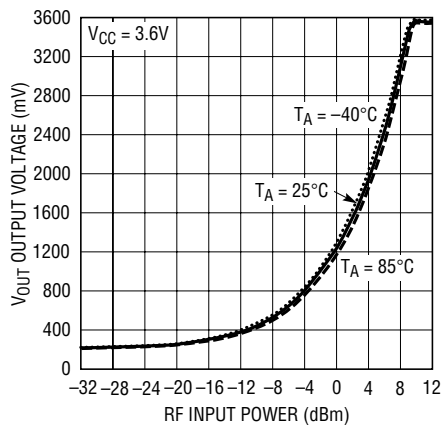

5535 G05

Typical Detector Characteristics, 3000MHz, Gain = 2, $V_{OS} = 0V$

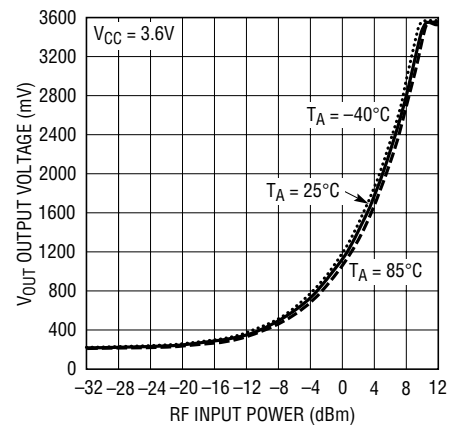

5535 G06

Typical Detector Characteristics, 4000MHz, Gain = 2, $V_{OS} = 0V$

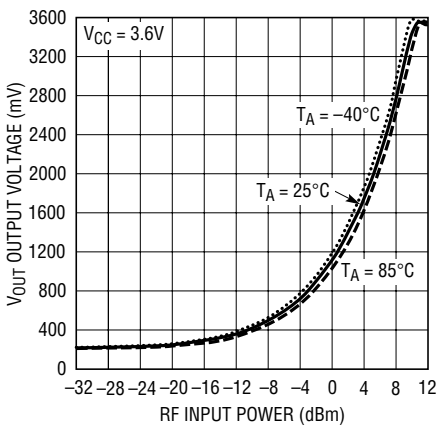

5535 G07

Typical Detector Characteristics, 5000MHz, Gain = 2, $V_{OS} = 0V$

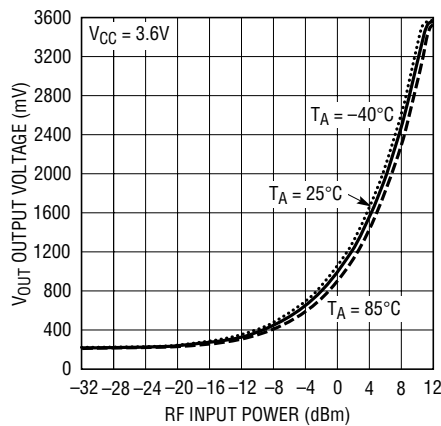

5535 G08

Typical Detector Characteristics, 6000MHz, Gain = 2, $V_{OS} = 0V$

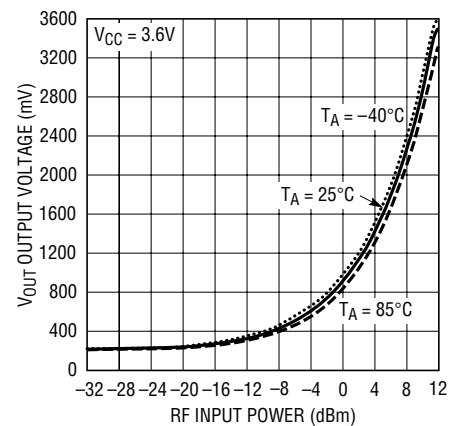

5535 G09

TYPICAL PERFORMANCE CHARACTERISTICS ($R_{LOAD} = 1k = R_A + R_B$)

Typical Detector Characteristics, 7000MHz, Gain = 2, $V_{OS} = 0V$

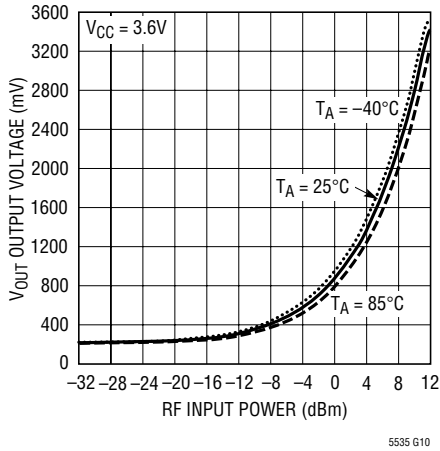

V_{OUT} vs RF Input Power and V_{CC} , 2000MHz, Gain = 2, $V_{OS} = 0V$, $T_A = 25^\circ C$

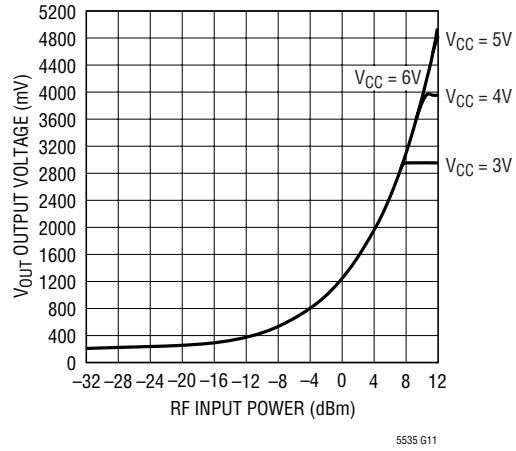

V_{OUT} vs RF Input Power and V_{OS} , 2000MHz, Gain = 2

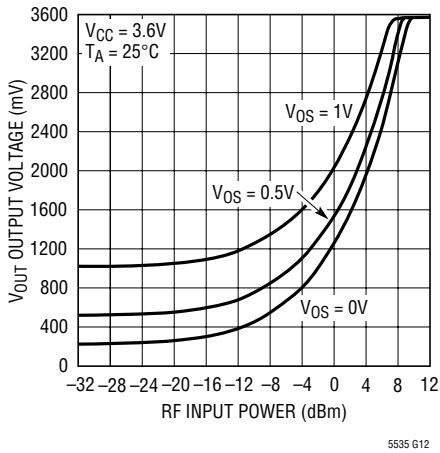

Typical Detector Characteristics, 2000MHz, Gain = 4, $V_{OS} = 0V$

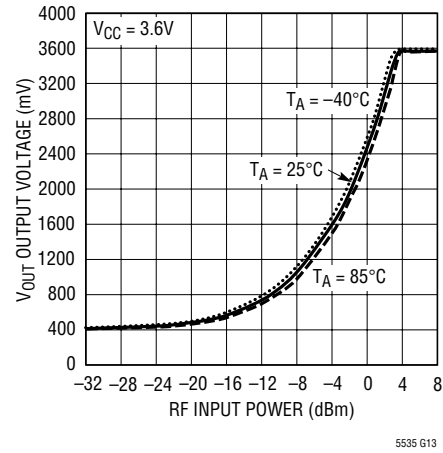

Time Domain Response at $f_{RF} = 1900MHz$, $P_{RF} = 0dBm$

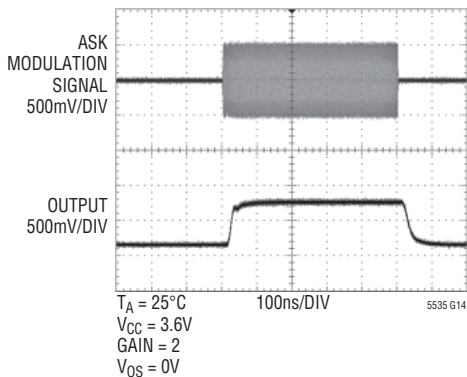

Time Domain Response at $f_{RF} = 1900MHz$, $P_{RF} = -10dBm$

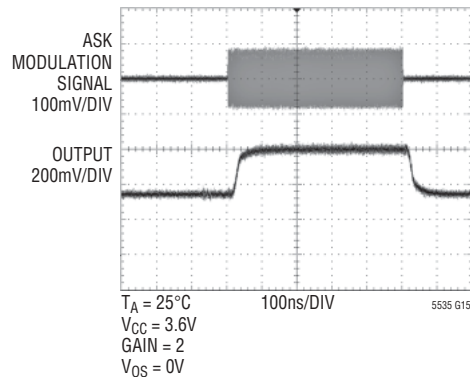

TYPICAL PERFORMANCE CHARACTERISTICS ($R_{LOAD} = 1k = R_A + R_B$)

V_{OUT} Slope vs RF Input Power at 600MHz

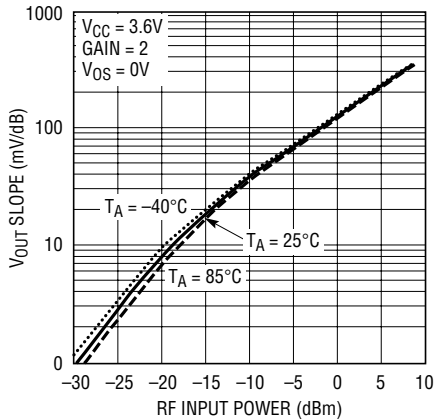

5535 G16

V_{OUT} Slope vs RF Input Power at 1000MHz

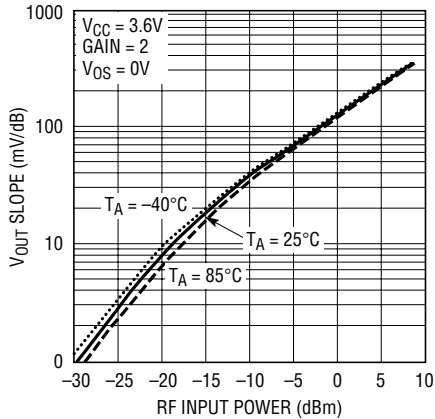

5535 G17

V_{OUT} Slope vs RF Input Power at 2000MHz

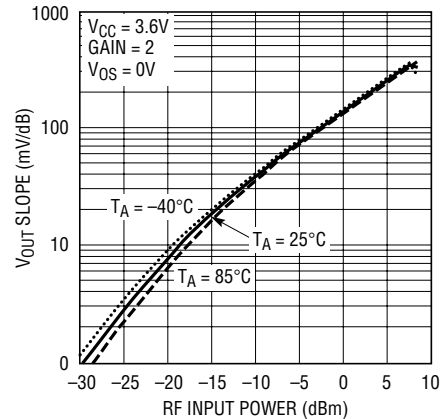

5535 G18

V_{OUT} Slope vs RF Input Power at 3000MHz

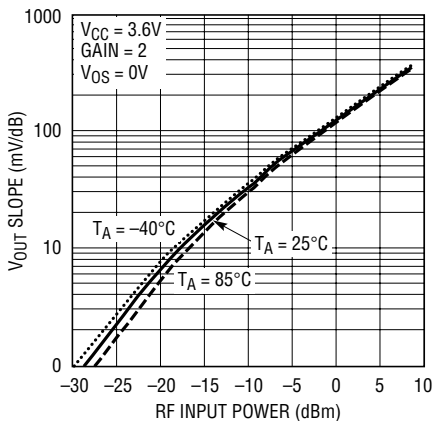

5535 G19

V_{OUT} Slope vs RF Input Power at 4000MHz

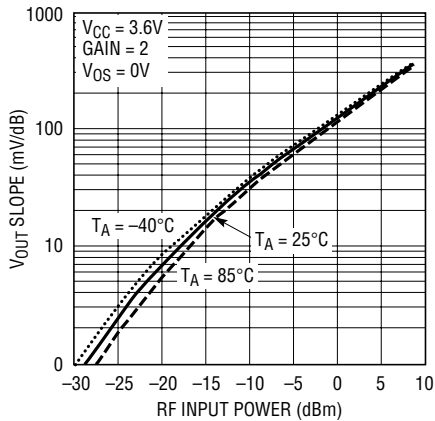

5535 G20

V_{OUT} Slope vs RF Input Power at 5000MHz

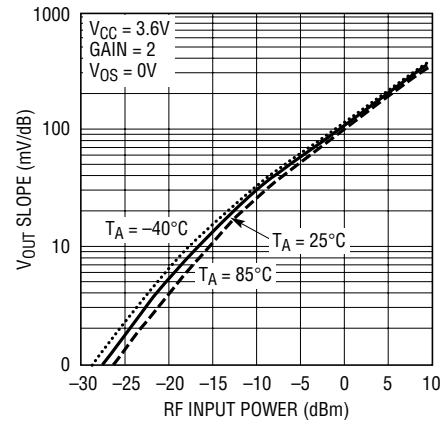

5535 G21

V_{OUT} Slope vs RF Input Power at 6000MHz

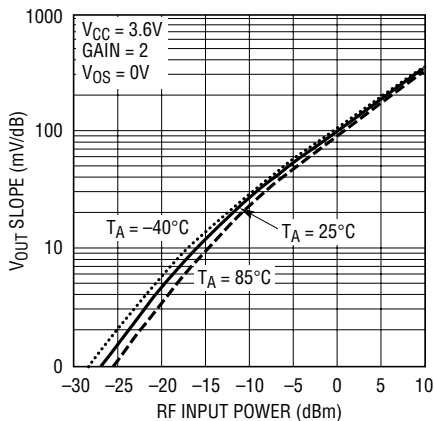

5535 G22

V_{OUT} Slope vs RF Input Power at 7000MHz

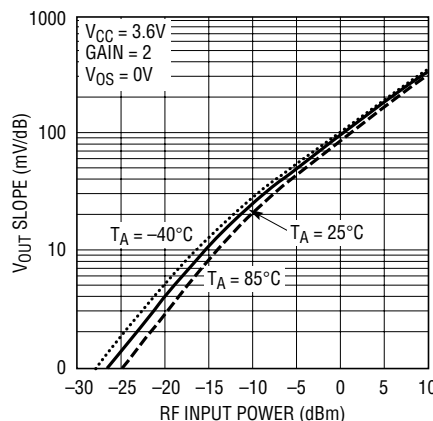

5535 G23

TYPICAL PERFORMANCE CHARACTERISTICS

RF_{IN} Input Impedance (P_{in} = -25 dBm, V_{CC} = 3.6V, T_A = 25°C)

FREQUENCY GHz	RESISTANCE (Ω)	REACTANCE (Ω)
0.600	156.68	-127.09
0.728	135.50	-122.64
0.856	118.45	-116.93
0.984	104.52	-110.97
1.112	92.64	-105.02
1.240	83.35	-98.29
1.368	75.36	-92.40
1.496	68.73	-86.52
1.624	63.20	-80.86
1.752	58.56	-75.65
1.880	54.68	-70.56
2.008	51.40	-65.59
2.136	49.37	-60.89
2.264	47.90	-57.97
2.392	44.55	-55.20
2.520	41.81	-51.32
2.648	39.91	-47.76
2.776	38.28	-44.50
2.904	37.15	-41.35
3.032	35.94	-38.47
3.160	34.94	-35.89
3.288	33.78	-33.39
3.416	32.33	-30.93
3.544	31.04	-28.47
3.672	29.80	-25.80
3.800	28.71	-23.12
3.928	27.85	-20.43
4.056	27.29	-18.04
4.184	26.34	-15.61
4.312	25.48	-13.05
4.440	24.95	-10.41
4.568	24.50	-7.76
4.696	23.95	-5.20
4.824	23.67	-2.56
4.952	23.47	0.03
5.080	23.40	2.59
5.208	23.39	5.13
5.336	23.50	7.64
5.464	23.72	10.20

FREQUENCY GHz	RESISTANCE (Ω)	REACTANCE (Ω)
5.592	24.09	12.74
5.720	24.60	15.21
5.848	25.20	17.55
5.976	26.02	19.70
6.104	26.80	21.46
6.232	27.27	22.90
6.360	27.22	24.41
6.488	26.98	26.35
6.616	26.79	28.58
6.744	26.75	31.11
6.872	26.85	33.76
7.000	27.06	36.48

S11 Forward Reflection Impedance

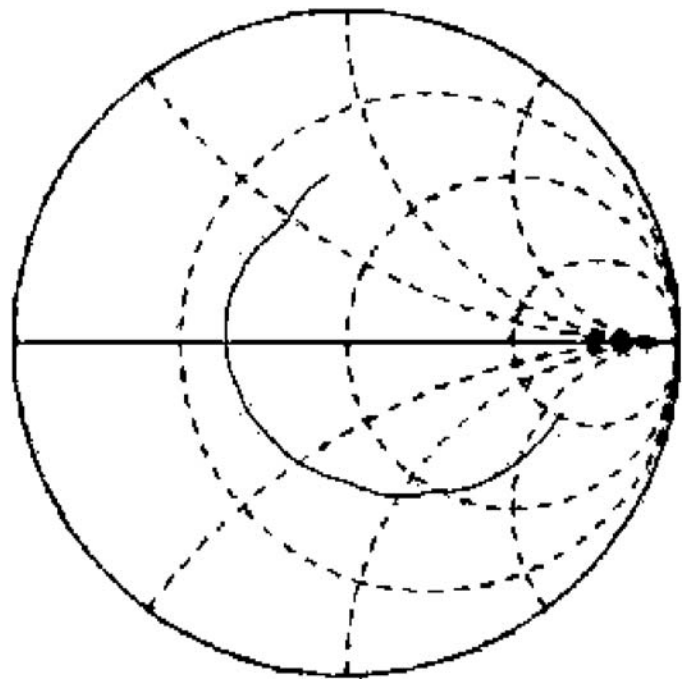

0.6000GHz-7.000GHz

5535 TA03

5535f

TYPICAL PERFORMANCE CHARACTERISTICS

RF_{IN} Input Impedance (P_{in} = 0dBm, V_{CC} = 3.6V, T_A = 25°C)

FREQUENCY (GHz)	RESISTANCE (Ω)	REACTANCE (Ω)
0.600	176.00	-174.00
0.728	148.00	-165.00
0.856	125.00	-153.00
0.984	108.00	-143.00
1.112	94.80	-133.00
1.240	83.20	-123.00
1.368	74.60	-115.00
1.496	67.50	-107.00
1.624	61.40	-99.00
1.752	56.80	-92.90
1.880	52.70	-86.10
2.008	49.30	-80.00
2.136	47.10	-74.40
2.264	45.30	-70.00
2.392	42.40	-66.70
2.520	39.60	-62.30
2.648	37.70	-58.60
2.776	36.30	-55.00
2.904	35.10	-51.00
3.032	34.00	-47.70
3.160	33.20	-44.60
3.288	32.10	-41.80
3.416	30.70	-39.50
3.544	29.10	-36.70
3.672	27.70	-33.70
3.800	26.60	-30.60
3.928	25.70	-27.70
4.056	25.00	-25.10
4.184	24.10	-22.10
4.312	23.50	-19.50
4.440	22.90	-17.10
4.568	22.40	-14.00
4.696	22.00	-11.40
4.824	21.70	-8.83
4.952	21.30	-5.99
5.080	21.20	-3.45
5.208	21.20	-0.77
5.336	21.20	1.70
5.464	21.40	4.46

FREQUENCY GHz	RESISTANCE (Ω)	REACTANCE (Ω)
5.592	21.80	7.14
5.720	22.10	9.55
5.848	22.70	12.00
5.976	23.60	14.40
6.104	24.20	15.90
6.232	24.70	17.80
6.360	24.70	19.30
6.488	24.30	21.40
6.616	24.10	23.80
6.744	24.00	26.30
6.872	24.00	28.80
7.000	24.10	31.40

S11 Forward Reflection Impedance

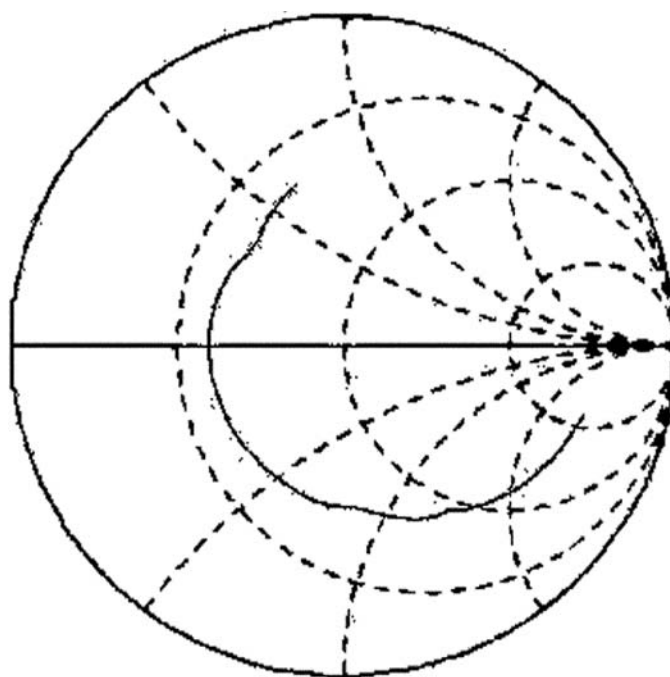

0.6000GHz-7.000GHz

5535 TA04

PIN FUNCTIONS

RF_{IN} (Pin 1): RF Input Voltage. Referenced to V_{CC}. A coupling capacitor must be used to connect to the RF signal source. The frequency range is 600MHz to 7GHz. This pin has an internal 500Ω termination, an internal Schottky diode detector and a peak detector capacitor.

GND (Pin 2): Ground.

V_{OS} (Pin 3): V_{OUT} Offset Voltage Adjustment. From 0V to 200mV, V_{OUT} does not change. Above 200mV, V_{OUT} will track V_{OS}.

V_M (Pin 4): Negative Input to Output Amplifier.

V_{OUT} (Pin 5): Detector Output.

V_{CC} (Pin 6): Power Supply Voltage, 2.7V to 5.5V. V_{CC} should be bypassed appropriately with ceramic capacitors.

BLOCK DIAGRAM

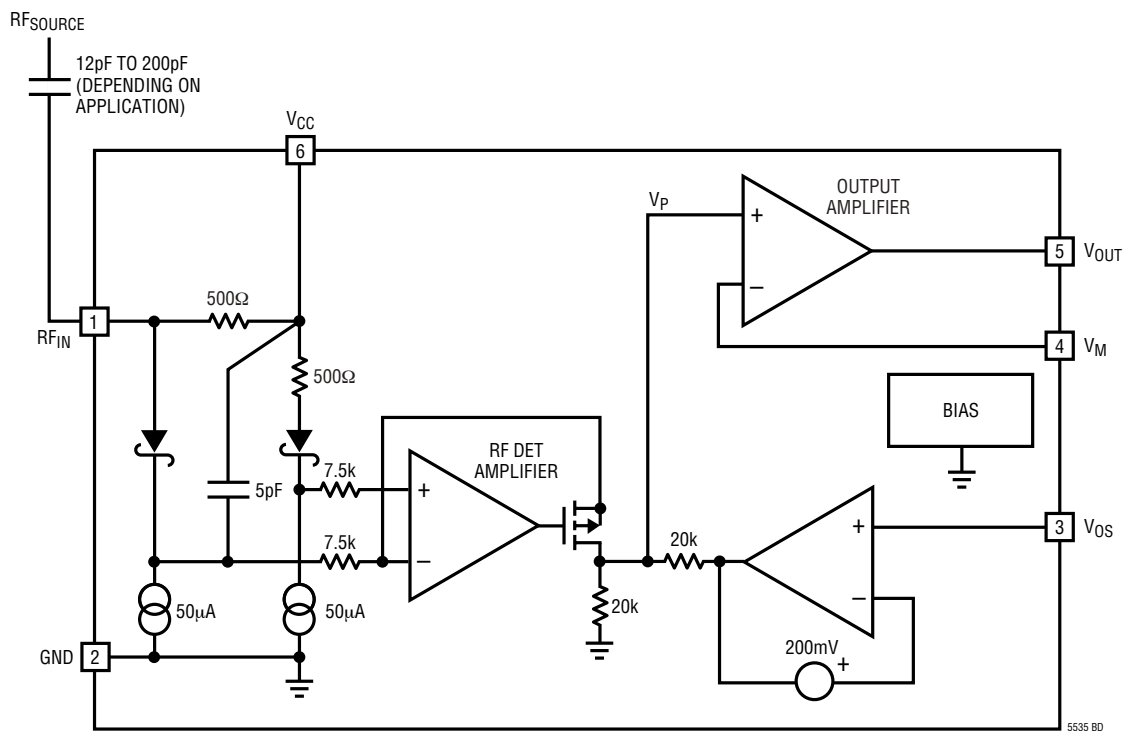

APPLICATIONS INFORMATION

Operation

The LTC5535 RF detector integrates several functions to provide RF power detection over frequencies ranging from 600MHz to 7GHz. These functions include an internal frequency compensated output amplifier, an RF Schottky diode peak detector and a level shift amplifier to convert the RF input signal to DC. The LTC5535 has both gain setting and voltage offset adjustment capabilities.

Output Amplifier

The output amplifier is capable of supplying typically 20mA into a load. The negative terminal V_M is brought out to a pin for gain selection. External resistors connected between V_{OUT} and V_M (R_A) and V_M to ground (R_B) will set the gain of this amplifier.

$$\text{Gain} = 1 + R_A/R_B$$

The amplifier is not unity gain stable; a minimum gain of two is required. The output amplifier has a bandwidth of 20MHz with a gain of 2. For increased gain applications, the bandwidth is reduced according to the formula:

$$\text{Bandwidth} = 40\text{MHz}/(\text{Gain}) = 40\text{MHz} \cdot R_B/(R_A + R_B)$$

For stable operation the gain setting resistors should be low values and the board capacitance on V_M should be minimized. R_B is recommended to be no greater than 500 Ω for all gain settings.

The V_{OS} input controls the DC input voltage to the output amplifier. V_{OS} must be connected to ground if the DC output voltage is not to be changed. The output amplifier is initially trimmed to 200mV (Gain = 2) with V_{OS} connected to ground.

The V_{OS} pin is used to change the initial V_{OUT} starting voltage. This function, in combination with gain adjustment enables the LTC5535 output to span the input range of a variety of analog-to-digital converters. V_{OUT} will not change until V_{OS} exceeds 200mV. The starting voltage at V_{OUT} for $V_{OS} > 200\text{mV}$ is:

$$V_{OUT} = 0.5 \cdot V_{OS} \cdot \text{Gain}$$

where gain is the output amplifier gain. For a gain of 2, V_{OUT} will exactly track V_{OS} above 200mV.

RF Detector

The internal RF Schottky diode peak detector and level shift amplifier converts the RF input signal to a low frequency signal. The detector demonstrates excellent efficiency and linearity over a wide range of input power. The Schottky diode is biased at about 50 μA and drives a 5pF internal peak detector capacitor.

Demo Board Schematic

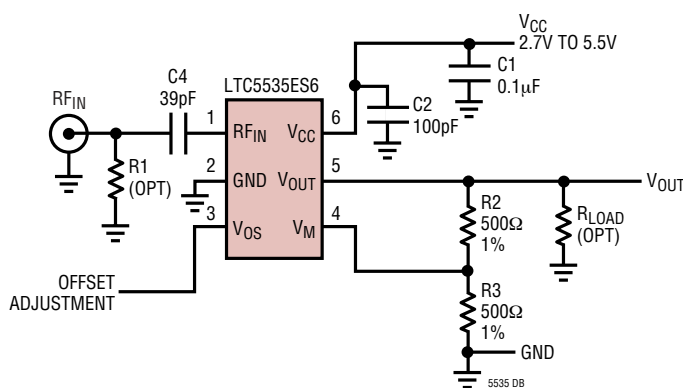

APPLICATIONS INFORMATION

Applications

The LTC5535 can be used as a self-standing signal strength measuring receiver for a wide range of input signals from -32dBm to 10dBm for frequencies from 600MHz to 7GHz .

The LTC5535 offers increased baseband bandwidth compared to other Schottky diode detectors. Table 1 shows that the baseband (demodulation) bandwidth is typically 12MHz at an RF input signal level of -10dBm . The baseband bandwidth is largely independent of the RF input signal frequency over the range of 600MHz to 7GHz .

Table 1

INPUT LEVEL (dBm)	OUTPUT BW -3dB (MHz)	FREQUENCY (GHz)	GAIN
-20	12.5	3	2
-10	12	3	2
-5	11	3	2
0	9.5	3	2

Operation at higher RF input frequencies is achievable. Consult factory for more information.

The LTC5535 can be used as a demodulator for AM and ASK modulated signals. Depending on specific application needs, the RSSI output can be split between two branches, providing AC-coupled data (or audio) output and a DC-coupled RSSI output for signal strength measurements and AGC.

PACKAGE DESCRIPTION

S6 Package
6-Lead Plastic TSOT-23
 (Reference LTC DWG # 05-08-1636)

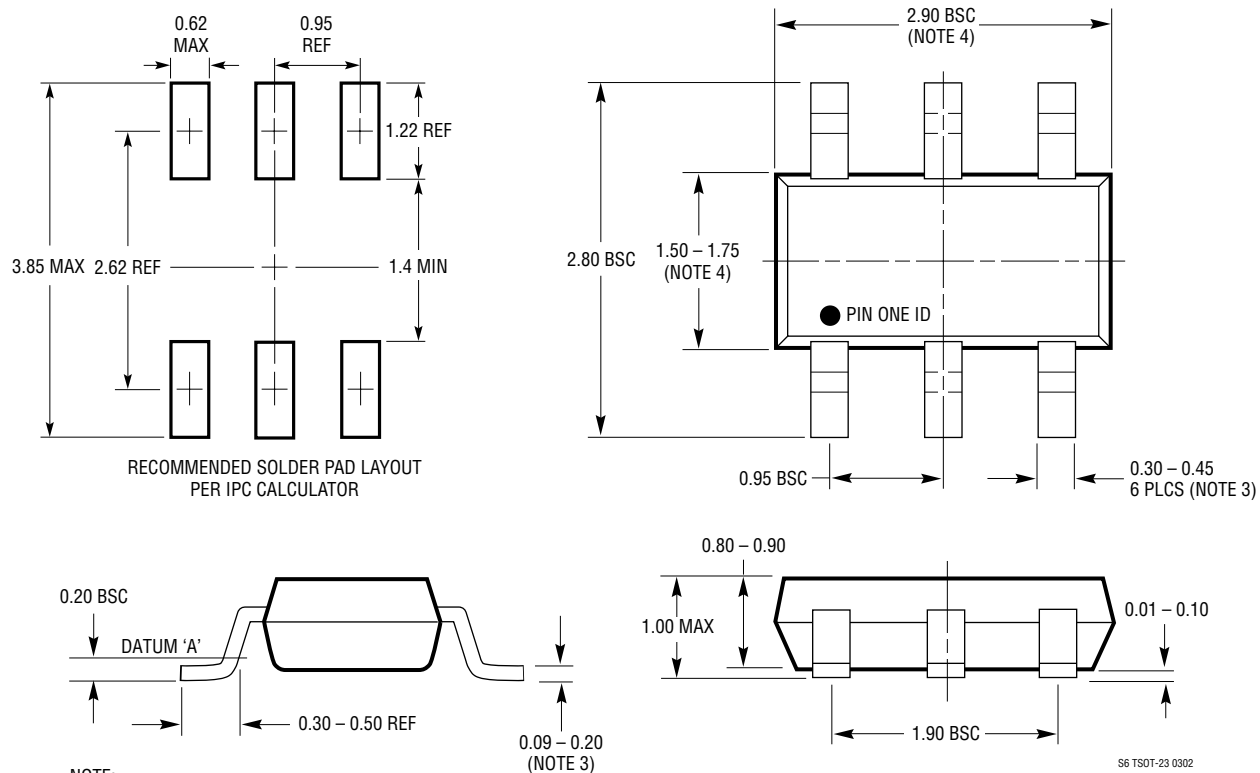

RELATED PARTS

PART NUMBER	DESCRIPTION	COMMENTS
Infrastructure		
LT [®] 5511	High Linearity Upconverting Mixer	RF Output to 3GHz, 17dBm IIP3, Integrated LO Buffer
LT5512	DC-3GHz High Signal Level Downconverting Mixer	DC to 3GHz, 21dBm IIP3, Integrated LO Buffer
LT5514	Ultralow Distortion IF Amplifier/ADC Driver	Digitally Controlled Gain, 47dBm OIP3 at 100MHz
LT5515	1.5GHz to 2.5GHz Direct Conversion Quadrature Demodulator	20dBm IIP3, Integrated LO Quadrature Generator
LT5516	0.8GHz to 1.5GHz Direct Conversion Quadrature Demodulator	21.5dBm IIP3, Integrated LO Quadrature Generator
LT5517	40MHz to 900MHz Direct Conversion Quadrature Demodulator	21dBm IIP3, Integrated LO Quadrature Generator
LT5519	0.7GHz to 1.4GHz High Linearity Upconverting Mixer	17.1dBm IIP3, 50Ω Single Ended RF and LO Ports
LT5520	1.3GHz to 2.3GHz High Linearity Upconverting Mixer	15.9dBm IIP3, 50Ω Single Ended RF and LO Ports
LT5521	Very High Linearity Active Mixer	24dBm IIP3, -42dBm LO Leakage at 1950MHz
LT5522	600MHz to 2.7GHz High Linearity Downconverting Mixer	4.5V to 5.25V Supply, 25dBm IIP3 at 900MHz, NF = 12.5dB, 50Ω Single-Ended RF and LO Ports
RF Power Detectors		
LT5504	800MHz to 2.7GHz RF Measuring Receiver	80dB Dynamic Range, Temperature Compensated, 2.7V to 5.25V Supply
LTC5505	300MHz to 3GHz RF Power Detectors	LTC5505-1: -28dBm to 18dBm Range, LTC5505-2: -32dBm to 12dBm Range, Temperature Compensated, 2.7V to 6V Supply
LTC5507	100kHz to 1000MHz RF Power Detector	-34dBm to 14dBm Range, Temperature Compensated, 2.7V to 6V Supply
LTC5508	300MHz to 7GHz RF Power Detector	-32dBm to 12dBm Range, Temperature Compensated, SC70 Package
LTC5509	300MHz to 3GHz RF Power Detector	36dB Dynamic Range, Temperature Compensated, SC70 Package
LTC5532	300MHz to 7GHz Precision RF Power Detector	Precision V _{OUT} Offset Control, Adjustable Gain and Offset
LT5534	50MHz to 3GHz RF Power Detector	60dB Dynamic Range, Temperature Compensated
RF Building Blocks		
LT5500	1.8GHz to 2.7GHz Receiver Front End	1.8V to 5.25V Supply, Dual-Gain LNA, Mixer, LO Buffer
LT5502	400MHz Quadrature IF Demodulator with RSSI	1.8V to 5.25V Supply, 70MHz to 400MHz IF, 84dB Limiting Gain, 90dB RSSI Range
LT5503	1.2GHz to 2.7GHz Direct IQ Modulator and Upconverting Mixer	1.8V to 5.25V Supply, Four-Step RF Power Control, 120MHz Modulation Bandwidth
LT5506	500MHz Quadrature IF Demodulator with VGA	1.8V to 5.25V Supply, 40MHz to 500MHz IF, -4dB to 57dB Linear Power Gain, 8.8MHz Baseband Bandwidth
LT5546	500MHz Quadrature IF Demodulator with VGA and 17MHz Baseband Bandwidth	17MHz Baseband Bandwidth, 40MHz to 500MHz IF, 1.8V to 5.25V Supply, -7dB to 56dB Linear Power Gain
RF Power Controllers		
LTC1757A	RF Power Controller	Multiband GSM/DCS/GPRS Mobile Phones
LTC1758	RF Power Controller	Multiband GSM/DCS/GPRS Mobile Phones
LTC1957	RF Power Controller	Multiband GSM/DCS/GPRS Mobile Phones
LTC4400	SOT-23 RF PA Controller	Multiband GSM/DCS/GPRS Phones, 45dB Dynamic Range, 450kHz Loop BW
LTC4401	SOT-23 RF PA Controller	Multiband GSM/DCS/GPRS Phones, 45dB Dynamic Range, 250kHz Loop BW
LTC4402	RF Power Controller for EDGE/TDMA	Multiband GSM/GPRS/EDGE Mobile Phones, 450kHz Loop BW
LTC4403	RF Power Controller for EDGE/TDMA	Multiband GSM/GPRS/EDGE Mobile Phones, 250kHz Loop BW