

# Dual 750mA/250mA Low Dropout, Low Noise, Micropower Linear Regulator

## FEATURES

- **Output Current: 750mA/250mA**
- **Low Dropout Voltage: 300mV**
- **Low Noise: 20 $\mu$ V<sub>RMS</sub> (10Hz to 100kHz)**
- **Low Quiescent Current: 120 $\mu$ A/75 $\mu$ A**
- Wide Input Voltage Range: 1.8V to 20V
- Adjustable Output: 1.220V Reference Voltage
- Shutdown Quiescent Current: <1 $\mu$ A
- Stable with 10 $\mu$ F/3.3 $\mu$ F Minimum Output Capacitor
- Stable with Ceramic, Tantalum or Aluminum Electrolytic Capacitors
- Precision Threshold for Shutdown Logic or UVLO Function
- PWRGD Flag for each Output
- Reverse Battery and Reverse Output-to-Input Protection
- Current Limit with Foldback and Thermal Shutdown
- Thermally Enhanced 20-Lead TSSOP and 28-Lead (4mm × 5mm) QFN Packages

## APPLICATIONS

- General Purpose Linear Regulator
- Battery-Powered Systems
- Microprocessor Core/Logic Supplies
- Post Regulator for Switching Supplies
- Tracking/Sequencing Power Supplies

LT, LT, LTC, LTM, Linear Technology and the Linear logo are registered trademarks and ThinSOT is a trademark of Linear Technology Corporation. All other trademarks are the property of their respective owners.

## DESCRIPTION

The LT<sup>®</sup>3030 is a dual, micropower, low noise, low dropout linear regulator. The device operates with either common or independent input supplies for each channel, over a 1.8V to 20V input voltage range. Output 1/Output 2 supply 750mA/250mA respectively with a typical dropout voltage of 300mV. With an external 10nF bypass capacitor, output noise is only 20 $\mu$ V<sub>RMS</sub> over a 10Hz to 100kHz bandwidth. Designed for use in battery-powered systems, the low 120 $\mu$ A/75 $\mu$ A quiescent current makes it an ideal choice. In shutdown, quiescent current drops to less than 1 $\mu$ A. Shutdown control is independent for each channel and its precision logic threshold allows for voltage lockout functionality. The LT3030 includes a PWRGD flag for each channel to indicate output regulation.

The LT3030 optimizes stability and transient response with low ESR ceramic output capacitors, requiring a minimum of only 10 $\mu$ F/3.3 $\mu$ F.

Internal circuitry provides reverse-battery protection, reverse-current protection, current limiting with foldback and thermal shutdown with hysteresis. The adjustable output voltage device has a 1.220V reference voltage. The LT3030 is offered in the thermally enhanced 20-lead TSSOP and 28-lead, low profile (4mm × 5mm × 0.75mm) QFN packages.

## TYPICAL APPLICATION

2.5V<sub>IN</sub> to 1.8V/1.5V Application

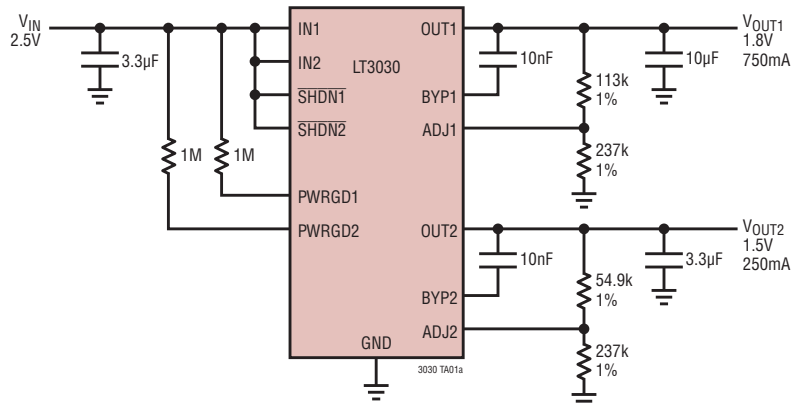

Dropout Voltage vs Load Current

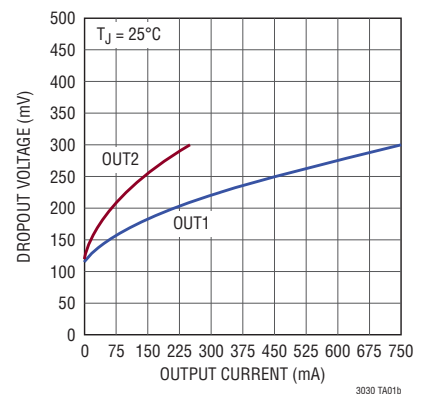

# LT3030

## ABSOLUTE MAXIMUM RATINGS

(Note 1)

IN1, IN2 Pin Voltage .....	±22V
OUT1, OUT2 Pin Voltage .....	±22V
Input-to-Output Differential Voltage .....	±22V
ADJ1, ADJ2 Pin Voltage .....	±9V
BYP1, BYP2 Pin Voltage .....	±0.6V
SHDN1, SHDN2 Pin Voltage .....	±22V
PWRGD1, PWRGD2 Pin Voltage .....	22V, -0.3V
Output Short-Circuit Duration .....	Indefinite

Operating Junction Temperature (Notes 2, 12)	
E-/I-Grade .....	-40°C to 125°C
H-Grade .....	-40°C to 150°C
MP-Grade .....	-55°C to 150°C
Storage Temperature Range	
QFN/TSSOP Package .....	-65°C to 150°C
Lead Temperature (Soldering, 10 sec)	
(TSSOP Only) .....	300°C

## PIN CONFIGURATION

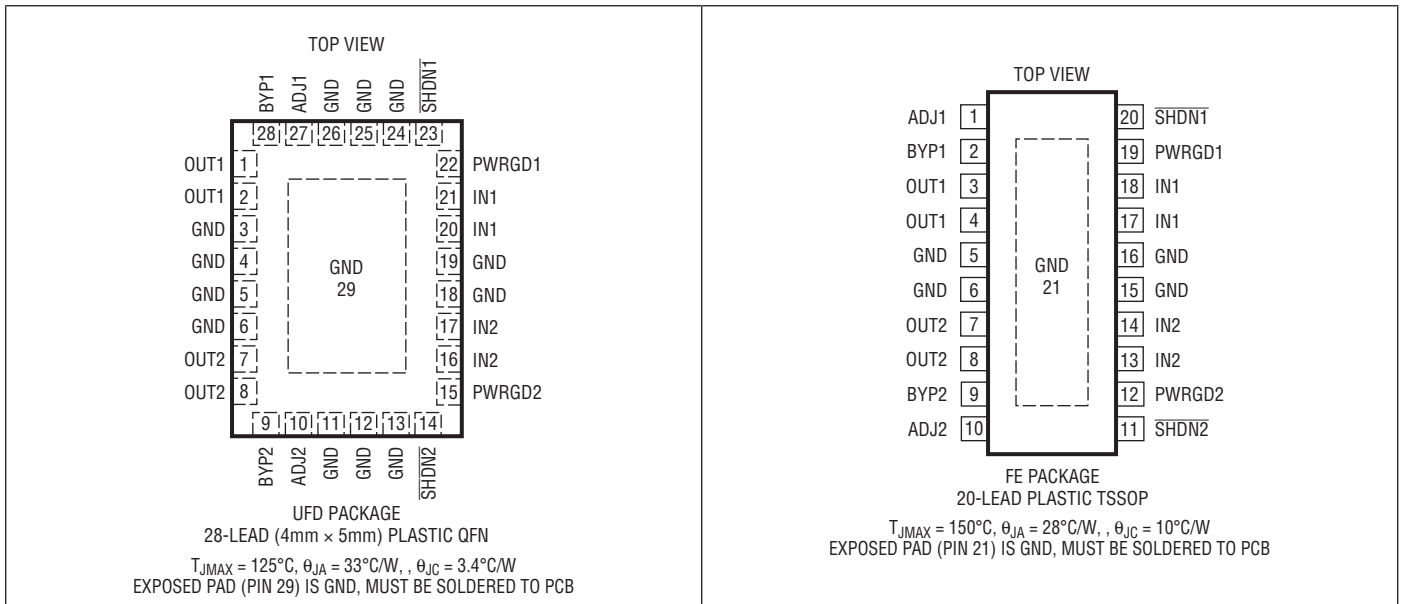

## ORDER INFORMATION

LEAD FREE FINISH	TAPE AND REEL	PART MARKING*	PACKAGE DESCRIPTION	TEMPERATURE RANGE
LT3030EUFDPBF	LT3030EUFDPTRPBF	3030	28-Lead (4mm × 5mm) Plastic QFN	-40°C to 125°C
LT3030IUFDPBF	LT3030IUFDPTRPBF	3030	28-Lead (4mm × 5mm) Plastic QFN	-40°C to 125°C
LT3030EFEPBF	LT3030EFETRPBF	LT3030FE	20-Lead Plastic TSSOP	-40°C to 125°C
LT3030IFEPBF	LT3030IFETRPBF	LT3030FE	20-Lead Plastic TSSOP	-40°C to 125°C
LT3030HFEPBF	LT3030HFETRPBF	LT3030FE	20-Lead Plastic TSSOP	-40°C to 150°C
LT3030MPFEPBF	LT3030MPFETRPBF	LT3030FE	20-Lead Plastic TSSOP	-55°C to 150°C

Consult LTC Marketing for parts specified with wider operating temperature ranges. \*The temperature grade is identified by a label on the shipping container.

For more information on lead free part marking, go to: <http://www.linear.com/leadfree/>

For more information on tape and reel specifications, go to: <http://www.linear.com/tapeandreel/>

**ELECTRICAL CHARACTERISTICS** The ● denotes the specifications which apply over the full operating temperature range, otherwise specifications are at T<sub>A</sub> = 25°C (Note 2).

PARAMETER	CONDITIONS		MIN	TYP	MAX	UNITS
Minimum Input Voltage (Notes 3, 11)	Output 1, I <sub>LOAD</sub> = 750mA	●		1.7	2.2	V
	Output 2, I <sub>LOAD</sub> = 250mA	●		1.7	2.2	V
ADJ1, ADJ2 Pin Voltage (Notes 3, 4)	V <sub>IN</sub> = 2V, I <sub>LOAD</sub> = 1mA		1.208	1.220	1.232	V
	Output 1, 2.2V < V <sub>IN1</sub> < 20V, 1mA < I <sub>LOAD</sub> < 750mA	●	1.196	1.220	1.244	V
	Output 2, 2.2V < V <sub>IN2</sub> < 20V, 1mA < I <sub>LOAD</sub> < 250mA	●	1.196	1.220	1.244	V
Line Regulation (Note 3)	ΔV <sub>IN</sub> = 2V to 20V, I <sub>LOAD</sub> = 1mA	●		0.5	5	mV
Load Regulation (Note 3)	Output 1, V <sub>IN1</sub> = 2.2V, ΔI <sub>LOAD</sub> = 1mA to 750mA			2	6	mV
	V <sub>IN1</sub> = 2.2V, ΔI <sub>LOAD</sub> = 1mA to 750mA	●			10	mV
	Output 2, V <sub>IN2</sub> = 2.2V, ΔI <sub>LOAD</sub> = 1mA to 250mA			2	6	mV
	V <sub>IN2</sub> = 2.2V, ΔI <sub>LOAD</sub> = 1mA to 250mA	●			10	mV
Dropout Voltage (Output 1) V <sub>IN1</sub> = V <sub>OUT1(NOMINAL)</sub> (Notes 5, 6, 11)	I <sub>LOAD</sub> = 10mA			0.13	0.20	V
	I <sub>LOAD</sub> = 10mA	●			0.28	V
	I <sub>LOAD</sub> = 100mA			0.17	0.23	V
	I <sub>LOAD</sub> = 100mA	●			0.33	V
	I <sub>LOAD</sub> = 500mA			0.27	0.32	V
	I <sub>LOAD</sub> = 500mA	●			0.43	V
	I <sub>LOAD</sub> = 750mA			0.3	0.36	V
	I <sub>LOAD</sub> = 750mA	●			0.48	V
Dropout Voltage (Output 2) V <sub>IN2</sub> = V <sub>OUT2(NOMINAL)</sub> (Notes 5, 6, 11)	I <sub>LOAD</sub> = 10mA			0.14	0.20	V
	I <sub>LOAD</sub> = 10mA	●			0.28	V
	I <sub>LOAD</sub> = 50mA			0.18	0.24	V
	I <sub>LOAD</sub> = 50mA	●			0.32	V
	I <sub>LOAD</sub> = 100mA			0.22	0.28	V
	I <sub>LOAD</sub> = 100mA	●			0.38	V
	I <sub>LOAD</sub> = 250mA			0.3	0.36	V
	I <sub>LOAD</sub> = 250mA	●			0.48	V
GND Pin Current (Output 1) V <sub>IN1</sub> = V <sub>OUT1(NOMINAL)</sub> (Notes 5, 7)	I <sub>LOAD</sub> = 0mA	●		120	300	μA
	I <sub>LOAD</sub> = 10mA	●		420	800	μA
	I <sub>LOAD</sub> = 100mA	●		2	3.8	mA
	I <sub>LOAD</sub> = 500mA	●		9	17	mA
	I <sub>LOAD</sub> = 750mA	●		15	27	mA
GND Pin Current (Output 2) V <sub>IN2</sub> = V <sub>OUT2(NOMINAL)</sub> (Notes 5, 7)	I <sub>LOAD</sub> = 0mA	●		75	200	μA
	I <sub>LOAD</sub> = 10mA	●		330	600	μA
	I <sub>LOAD</sub> = 50mA	●		1	1.8	mA
	I <sub>LOAD</sub> = 100mA	●		1.8	3.4	mA
	I <sub>LOAD</sub> = 250mA	●		5	9	mA
Output Voltage Noise	C <sub>OUT</sub> = 10μF, C <sub>BYP</sub> = 10nF, I <sub>LOAD</sub> = Full Current (Note 13) BW = 10Hz to 100kHz			20		μV <sub>RMS</sub>
ADJ1/ADJ2 Pin Bias Current (Notes 3, 8)				30	100	nA
Shutdown Threshold	V <sub>OUT</sub> = Off to On	●	1.09	1.21	1.33	V
	V <sub>OUT</sub> = On to Off	●	0.5	0.83		V
	Hysteresis (Note 2)			0.38		V
SHDN1/SHDN2 Pin Current (Note 10)	V <sub>SHDN1</sub> , V <sub>SHDN2</sub> = 0V	●		0	0.5	μA
	V <sub>SHDN1</sub> , V <sub>SHDN2</sub> = 20V	●		0.85	3	μA
Quiescent Current in Shutdown (per Channel)	V <sub>IN</sub> = 20V, V <sub>SHDN1</sub> = 0V, V <sub>SHDN2</sub> = 0V			0.3	2	μA
PWRGD Trip Point	% of Nominal Output Voltage, Output Rising	●	86	90	94	%
PWRGD Trip Point Hysteresis (Note 2)	% of Nominal Output Voltage, Output Falling			1.6		%
PWRGD Output Low Voltage	I <sub>PWRGD</sub> = 100μA	●		15	150	mV
PWRGD Leakage Current	V <sub>SHDN</sub> = 0V, V <sub>PWRGD</sub> = 20V	●			1	μA

## ELECTRICAL CHARACTERISTICS

The ● denotes the specifications which apply over the full operating temperature range, otherwise specifications are at  $T_A = 25^\circ\text{C}$  (Note 2).

PARAMETER	CONDITIONS	MIN	TYP	MAX	UNITS
Ripple Rejection	$V_{IN} = 2.72\text{V (Avg)}$ , $V_{RIPPLE} = 0.5V_{P-P}$ , $f_{RIPPLE} = 120\text{Hz}$ , $I_{LOAD} = \text{Full Current (Note 13)}$	50	60		dB
	$V_{IN} = V_{OUT(NOMINAL)} + 1\text{V}$ , $V_{RIPPLE} = 50\text{mV}_{RMS}$ $f_{RIPPLE} = 1\text{MHz}$ , $I_{LOAD} = \text{Full Current (Note 13)}$		50		dB
Current Limit (Note 9)	Output 1, $V_{IN1} = 6\text{V}$ , $V_{OUT1} = 0\text{V}$ $V_{IN1} = 2.2\text{V}$ , $\Delta V_{OUT1} = -0.1\text{V}$	● ●	1.1 800	1.4 1.7	A mA
	Output 2, $V_{IN2} = 6\text{V}$ , $V_{OUT2} = 0\text{V}$ $V_{IN2} = 2.2\text{V}$ , $\Delta V_{OUT2} = -0.1\text{V}$	● ●	350 270	420 490	mA mA
Input Reverse Leakage Current	$V_{IN} = -20\text{V}$ , $V_{OUT} = 0\text{V}$	●		1	mA
Reverse Output Current	$V_{OUT} = 1.220\text{V}$ , $V_{IN} = 0\text{V}$		0.5	10	$\mu\text{A}$

**Note 1:** Stresses beyond those listed under Absolute Maximum Ratings may cause permanent damage to the device. Exposure to any Absolute Maximum Rating condition for extended periods may affect device reliability and lifetime.

**Note 2:** The LT3030 is tested and specified under pulse load conditions such that  $T_J \approx T_A$ . The LT3030E is 100% tested at  $T_A = 25^\circ\text{C}$  and performance is guaranteed from  $0^\circ\text{C}$  to  $125^\circ\text{C}$ . Performance of the LT3030E over the full  $-40^\circ\text{C}$  to  $125^\circ\text{C}$  operating junction temperature range is assured by design, characterization and correlation with statistical process controls. The LT3030I is guaranteed over the full  $-40^\circ\text{C}$  to  $125^\circ\text{C}$  operating junction temperature range. The LT3030MP is 100% tested and guaranteed over the  $-55^\circ\text{C}$  to  $150^\circ\text{C}$  operating junction temperature range. The LT3030H is tested at  $150^\circ\text{C}$  operating junction temperature. High junction temperatures degrade operating lifetimes. Operating lifetime is derated at junction temperatures greater than  $125^\circ\text{C}$ .

**Note 3:** The LT3030 is tested and specified for these conditions with the ADJ1/ADJ2 pin connected to the corresponding OUT1/OUT2 pin.

**Note 4:** Maximum junction temperature limits operating conditions. The regulated output voltage specification does not apply for all possible combinations of input voltage and output current. When operating at maximum input voltage, limit the output current range. When operating at maximum output current, limit the input voltage range.

**Note 5:** To satisfy minimum input voltage requirements, the LT3030 is tested and specified for these conditions with an external resistor divider (two 243k resistors) for an output voltage of 2.447V. The external resistor divider adds  $5\mu\text{A}$  of DC load on the output.

**Note 6:** Dropout voltage is the minimum input to output voltage differential needed to maintain regulation at a specified output current. In dropout, the output voltage equals:  $V_{IN} - V_{DROPOUT}$ .

**Note 7:** GND pin current is tested with  $V_{IN} = 2.447\text{V}$  and a current source load. This means the device is tested while operating in its dropout region or at the minimum input voltage specification. This is the worst-case GND pin current. The GND pin current decreases slightly at higher input voltages. Total GND pin current equals the sum of output 1 and output 2 GND pin currents.

**Note 8:** ADJ1/ADJ2 pin bias current flows into the pin.

**Note 9:** The LT3030 contains current limit foldback circuitry. See the Typical Performance Characteristics section for current limit as a function of the  $V_{IN} - V_{OUT}$  differential voltage.

**Note 10:** SHDN1 and SHDN2 pin current flows into the pin.

**Note 11:** The LT3030 minimum input voltage specification limits dropout voltage under some output voltage/load conditions. See the curve of Minimum Input Voltage in the Typical Performance Characteristics section.

**Note 12:** The LT3030 includes overtemperature protection that is intended to protect the device during momentary overload conditions. Junction temperature exceeds the maximum operating junction temperature when overtemperature protection is active. Continuous operation above the specified maximum operating junction temperature may impair device reliability.

**Note 13:** The Full Current for  $I_{LOAD}$  is 750mA and 250mA for Output 1 and Output 2 respectively.

**TYPICAL PERFORMANCE CHARACTERISTICS**  $T_J = 25^\circ\text{C}$ , unless otherwise noted.

**OUT1 Typical Dropout Voltage**

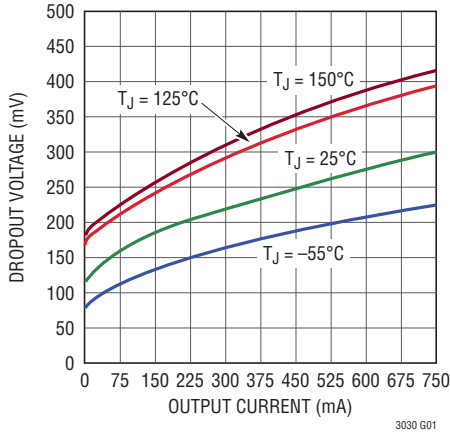

3030 G01

**OUT1 Guaranteed Dropout Voltage**

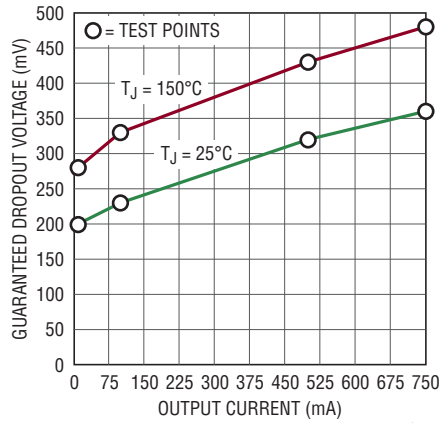

3030 G02

**OUT1 Dropout Voltage vs Temperature**

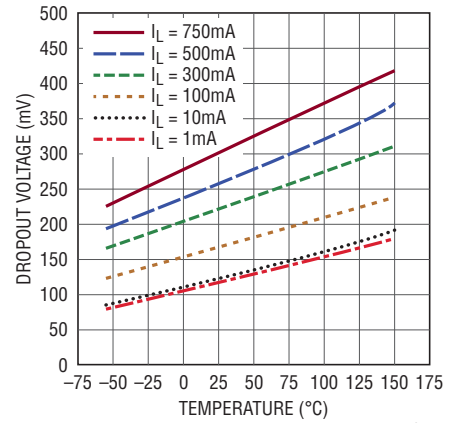

3030 G03

**OUT2 Typical Dropout Voltage**

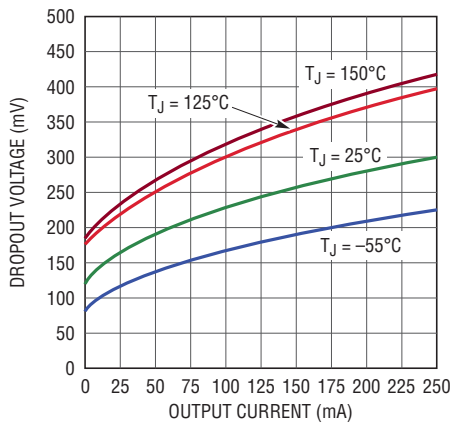

3030 G04

**OUT2 Guaranteed Dropout Voltage**

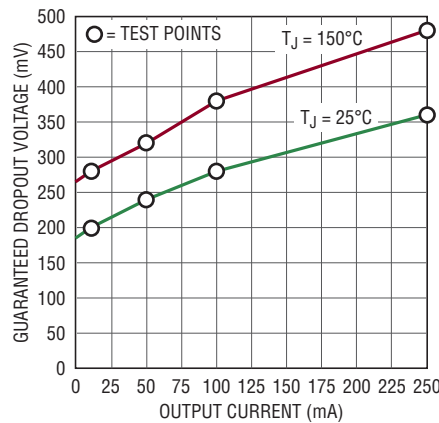

3030 G05

**OUT2 Dropout Voltage vs Temperature**

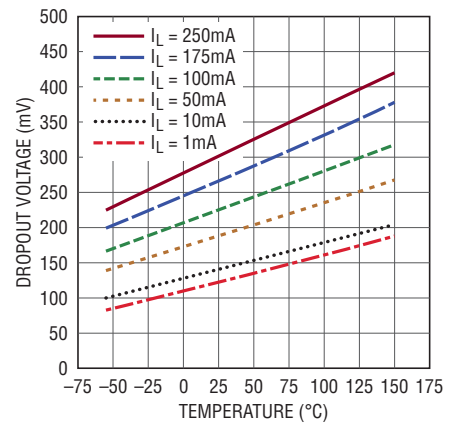

3030 G06

**Quiescent Current**

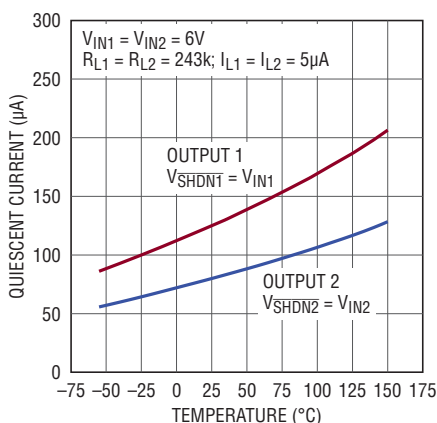

3030 G07

**ADJ1/ADJ2 Pin Voltage**

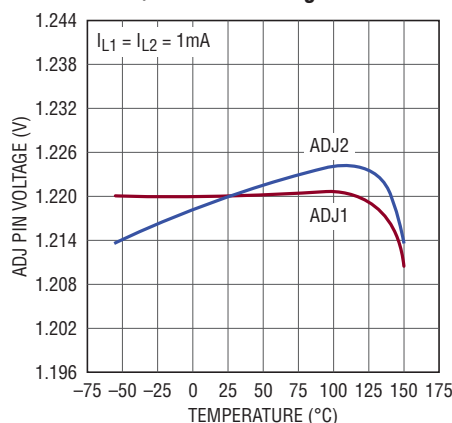

3030 G08

**Quiescent Current**

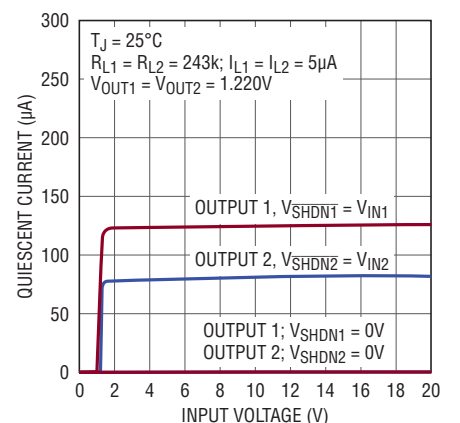

3030 G09

## TYPICAL PERFORMANCE CHARACTERISTICS $T_J = 25^\circ\text{C}$ , unless otherwise noted.

**Quiescent Current in Shutdown (per Output)**

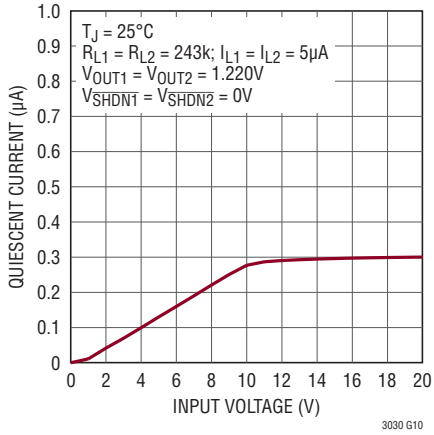

**OUT1 GND Pin Current**

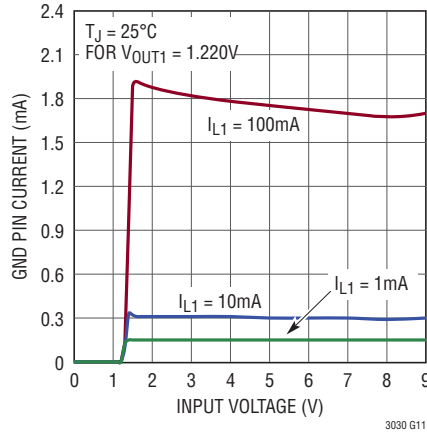

**OUT1 GND Pin Current**

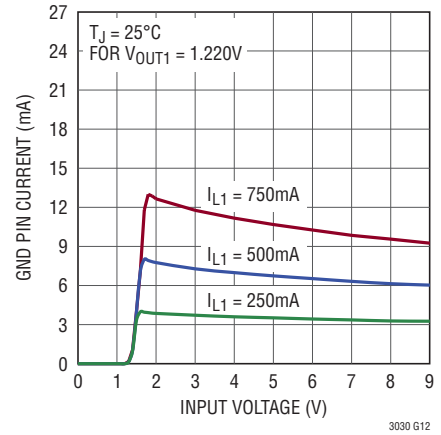

**OUT1 GND Pin Current**

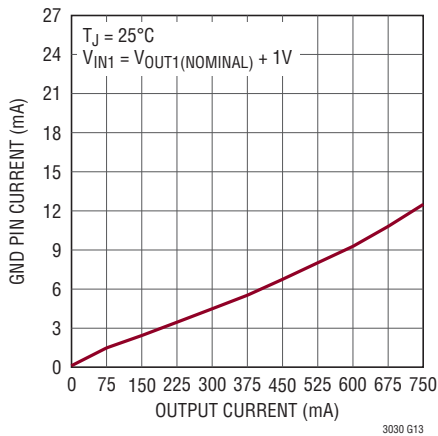

**OUT2 GND Pin Current**

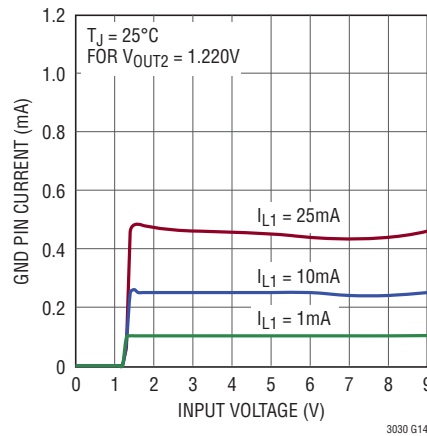

**OUT2 GND Pin Current**

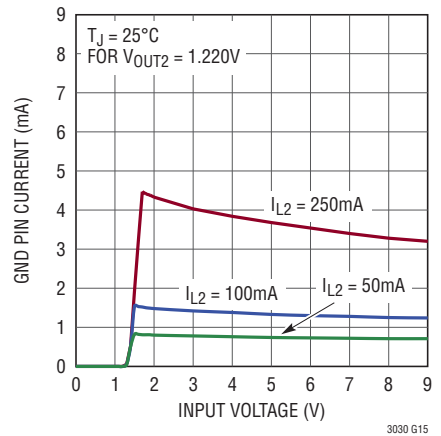

**OUT2 GND Pin Current**

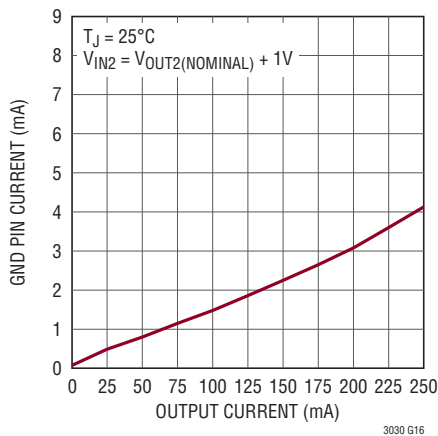

**SHDN1 or SHDN2 Pin Threshold**

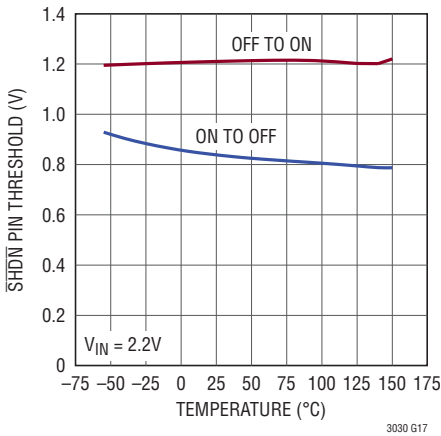

**SHDN1 or SHDN2 Pin Input Current**

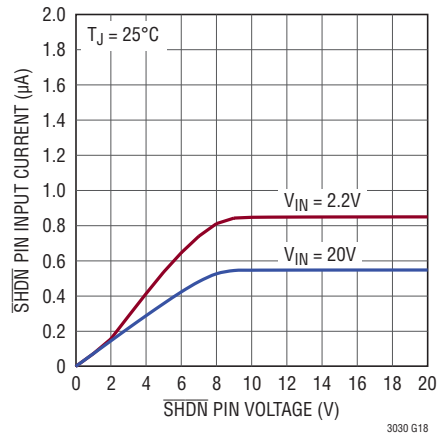

**TYPICAL PERFORMANCE CHARACTERISTICS**  $T_J = 25^\circ\text{C}$ , unless otherwise noted.

**SHDN1 or SHDN2 Pin Input Current**

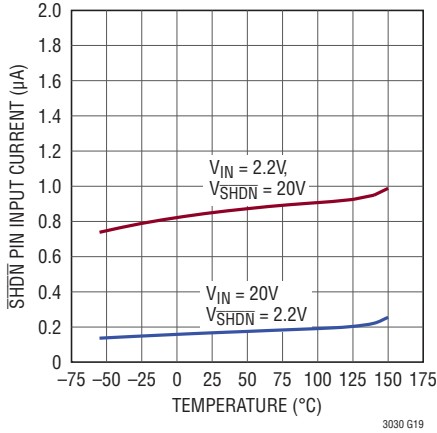

**ADJ1 or ADJ2 Pin Bias Current**

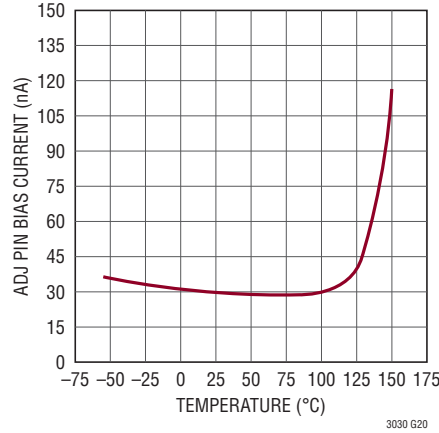

**PWRGD1 or PWRGD2 Trip Point**

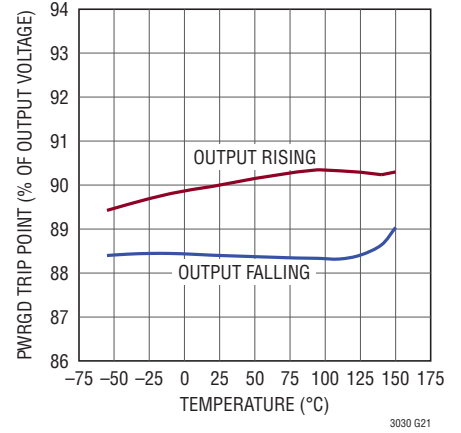

**PWRGD1 or PWRGD2 Output Low Voltage**

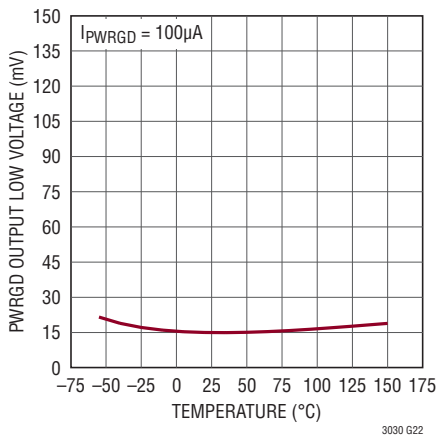

**OUT1 Current Limit**

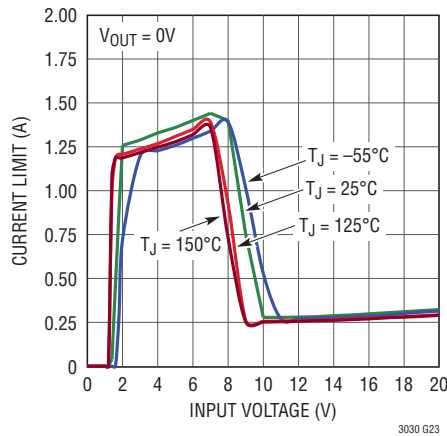

**OUT1 Current Limit**

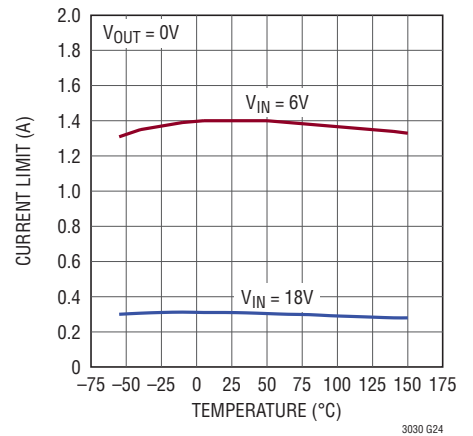

**OUT2 Current Limit**

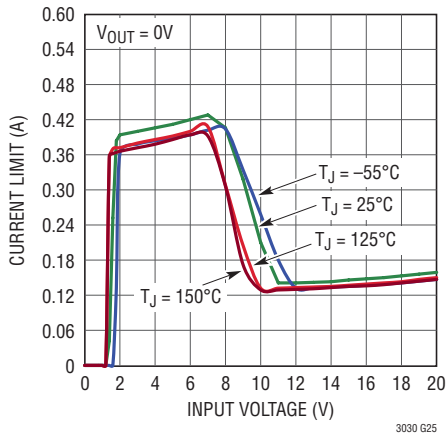

**OUT2 Current Limit**

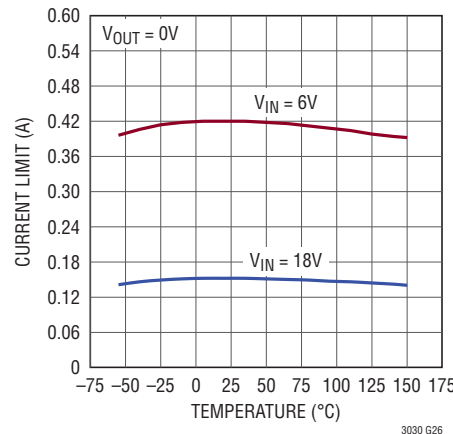

**Reverse Current**

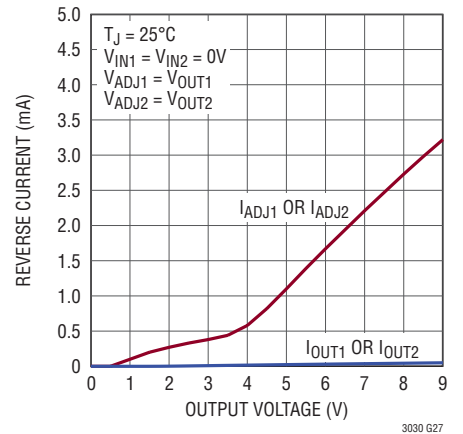

$I_{ADJ}$  = FLOWS INTO ADJ PIN TO GND PIN  
 $I_{OUT}$  = FLOWS INTO OUT PIN TO IN PIN

## TYPICAL PERFORMANCE CHARACTERISTICS $T_J = 25^\circ\text{C}$ , unless otherwise noted.

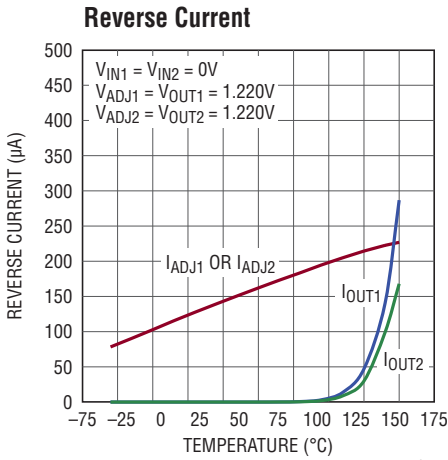

$I_{ADJ}$  = FLOWS INTO ADJ PIN TO GND PIN  
 $I_{OUT}$  = FLOWS INTO OUT PIN TO IN PIN

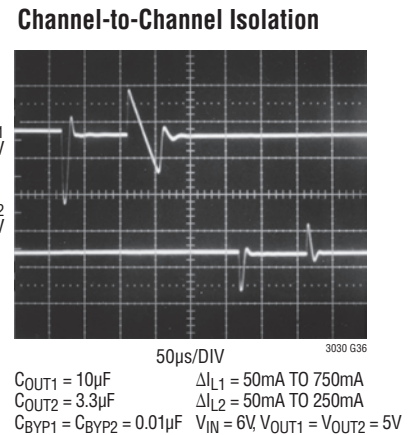
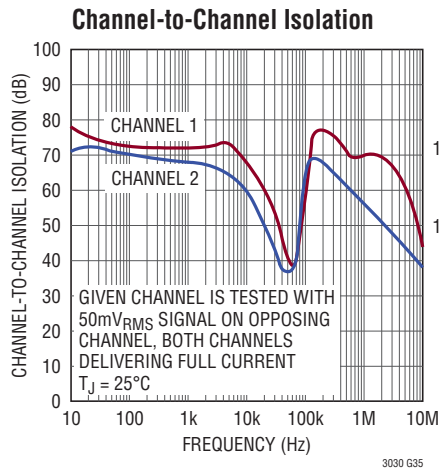
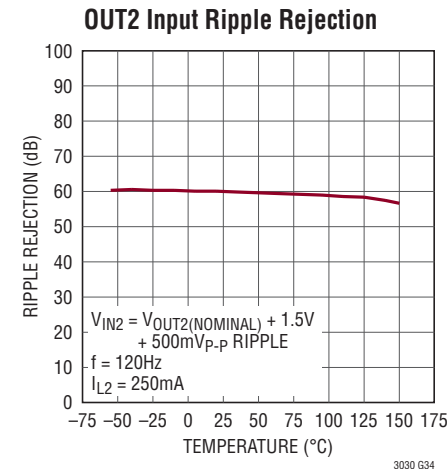
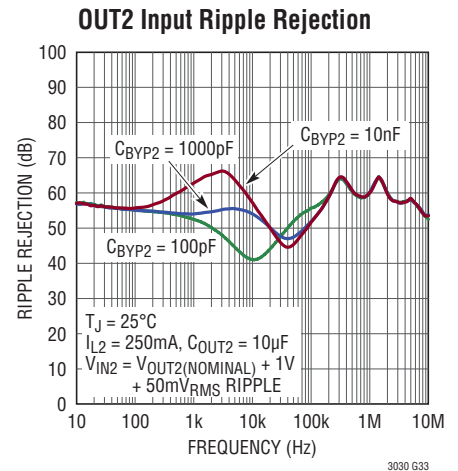
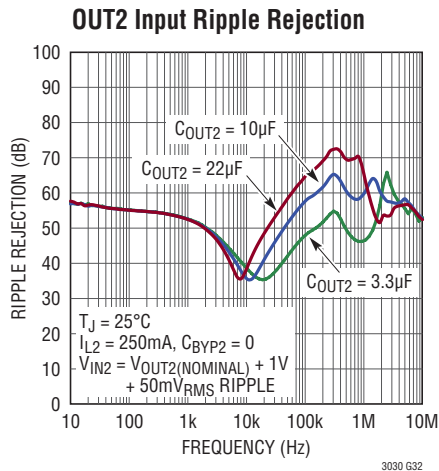
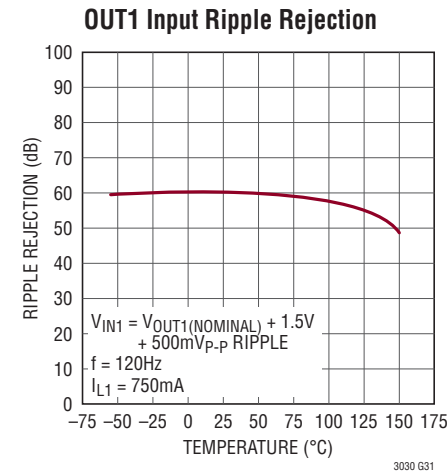
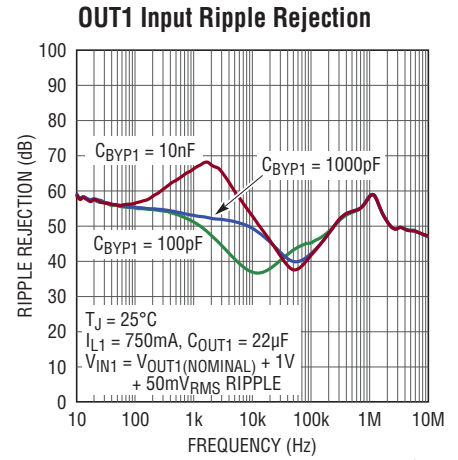
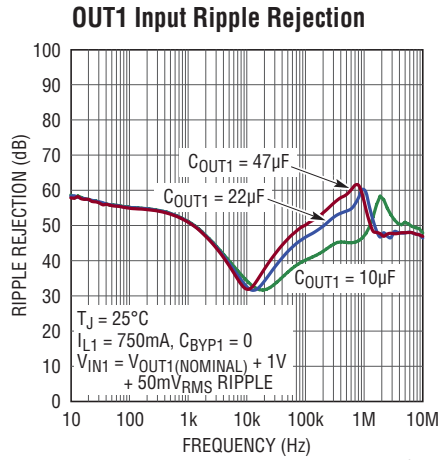



**TYPICAL PERFORMANCE CHARACTERISTICS**  $T_J = 25^\circ\text{C}$ , unless otherwise noted.

**OUT1 or OUT2 Load Regulation**

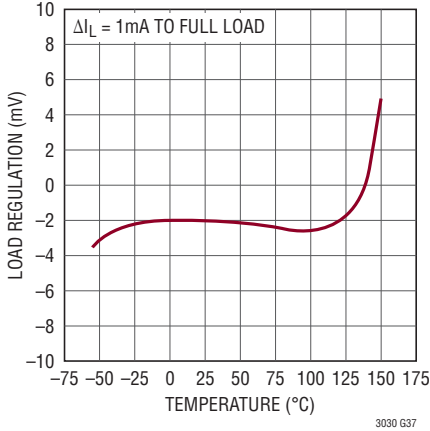

**OUT1 or OUT2 Line Regulation**

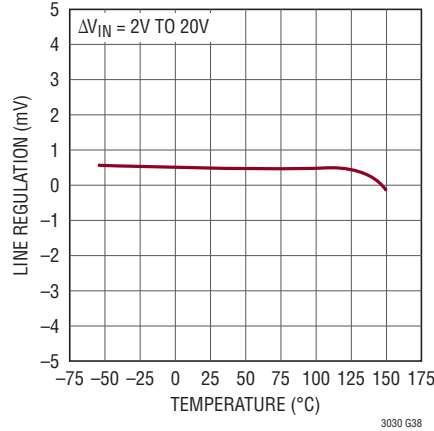

**Output Noise Spectral Density**

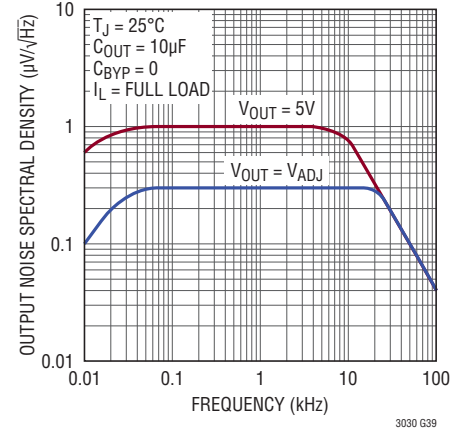

**Output Noise Spectral Density**

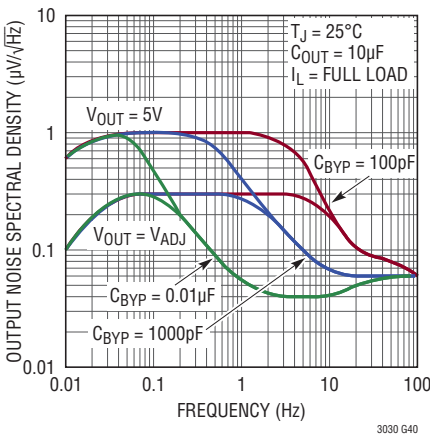

**RMS Output Noise vs Bypass Capacitor**

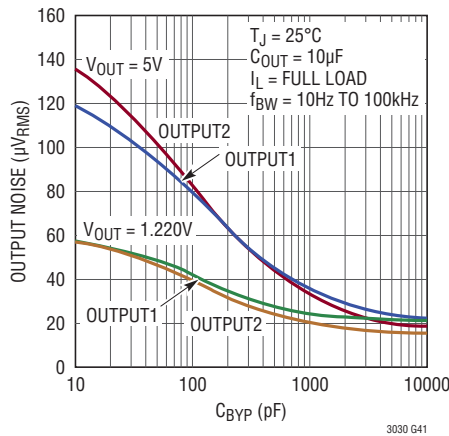

**OUT1 RMS Output Noise vs Output Current (10Hz to 100kHz)**

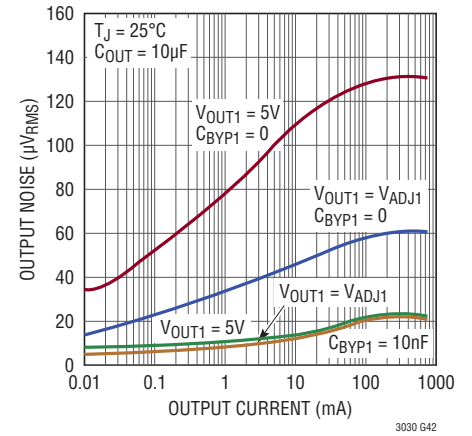

**OUT2 RMS Output Noise vs Output Current (10Hz to 100kHz)**

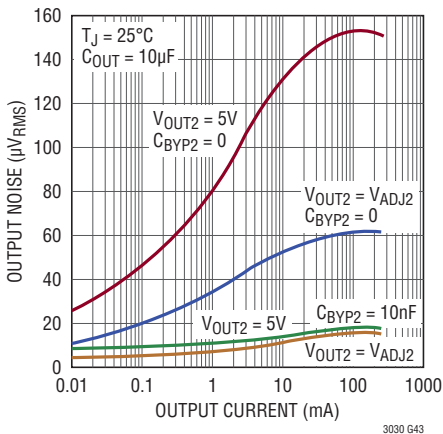

**Start-Up Time from Shutdown  $C_{BYP} = 0\mu\text{F}$**

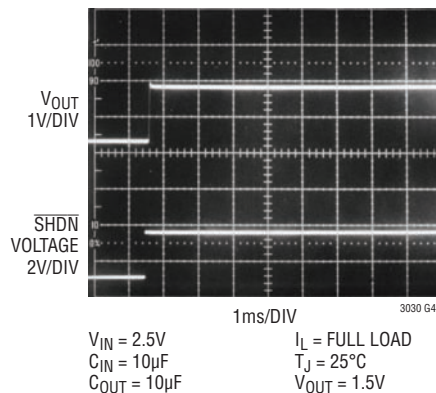

**Start-Up Time from Shutdown  $C_{BYP} = 0.01\mu\text{F}$**

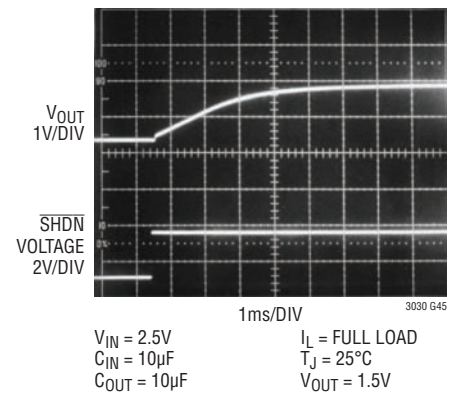

## TYPICAL PERFORMANCE CHARACTERISTICS $T_J = 25^\circ\text{C}$ , unless otherwise noted.

**OUT1 or OUT2 Minimum Input Voltage**

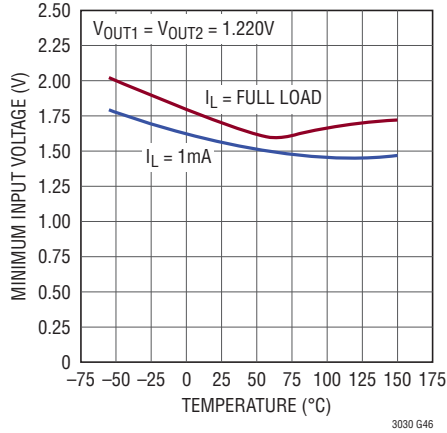

**10Hz to 100kHz Output Noise,  $C_{BYP} = 0\text{pF}$**

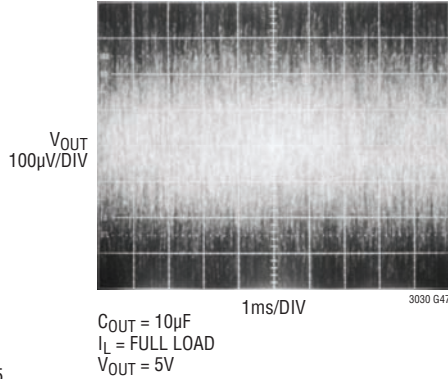

**10Hz to 100kHz Output Noise,  $C_{BYP} = 100\text{pF}$**

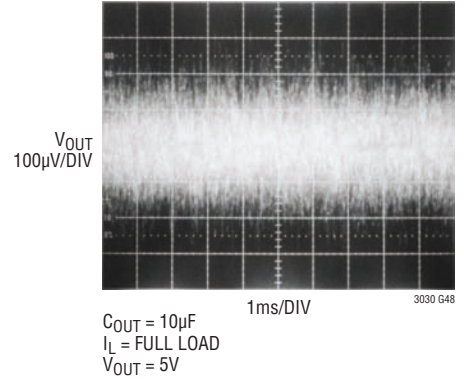

**10Hz to 100kHz Output Noise,  $C_{BYP} = 1000\text{pF}$**

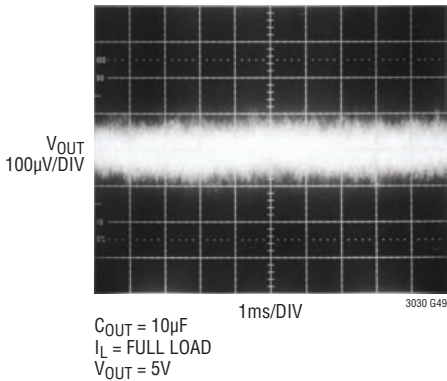

**10Hz to 100kHz Output Noise,  $C_{BYP} = 0.01\mu\text{F}$**

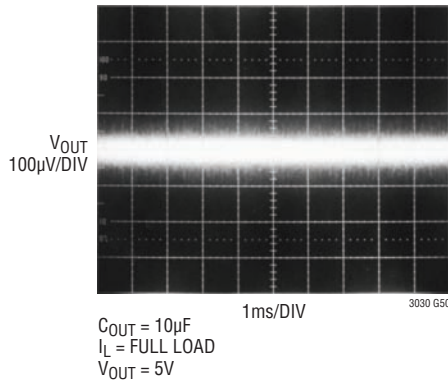

**OUT1 Transient Response  $C_{BYP} = 0\text{pF}$**

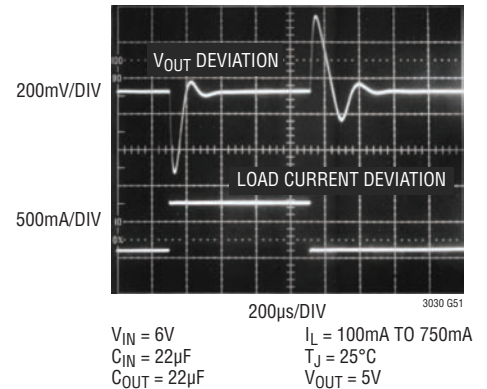

**OUT1 Transient Response  $C_{BYP} = 0.01\mu\text{F}$**

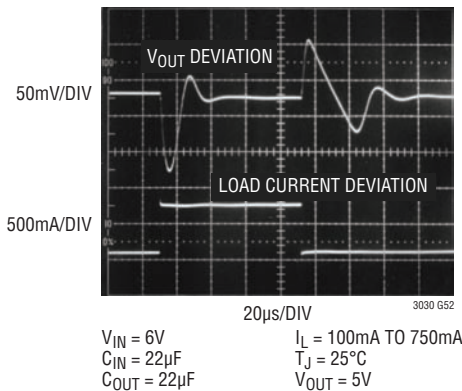

**OUT2 Transient Response  $C_{BYP} = 0\text{pF}$**

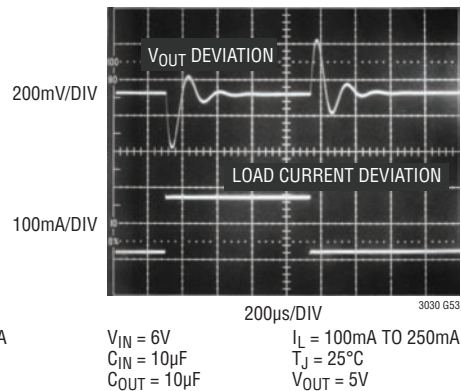

**OUT2 Transient Response  $C_{BYP} = 0.01\mu\text{F}$**

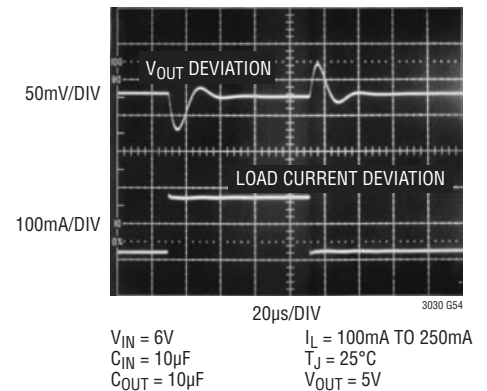

## PIN FUNCTIONS (QFN/TSSOP)

**OUT1, OUT2 (Pins 1, 2, 7, 8/Pins 3, 4, 7, 8):** Output. The OUT1/OUT2 pins supply power to the loads. A minimum  $10\mu\text{F}/3.3\mu\text{F}$  output capacitor prevents oscillations on OUT1/OUT2. Applications with large output load transients require larger values of output capacitance to limit peak voltage transients. See the Applications Information section for more on output capacitance and on reverse output characteristics.

**GND (Pins 3, 4, 5, 6, 11, 12, 13, 18, 19, 24, 25, 26, Exposed Pad Pin 29/Pins 5, 6, 15, 16, Exposed Pad Pin 21):** Ground. The exposed pad (backside) of the QFN and TSSOP packages is an electrical connection to GND. To ensure proper electrical and thermal performance, solder the exposed pad to the PCB ground and tie directly to GND pins. Connect the bottom of the output voltage setting resistor divider directly to GND for optimum load regulation performance.

**IN1, IN2 (Pins 20, 21, 16, 17/Pins 17, 18, 13, 14):** Input. The IN1/IN2 pins supply power to each channel. The LT3030 requires a bypass capacitor at the IN1/IN2 pins if located more than six inches away from the main input filter capacitor. Include a bypass capacitor in battery-powered circuits, as a battery's output impedance rises with frequency. A bypass capacitor in the range of  $1\mu\text{F}$  to  $10\mu\text{F}$  suffices. The LT3030's design withstands reverse voltages on the IN pins with respect to ground and the OUT pins. In the case of a reversed input, which occurs if a battery is plugged in backwards, the LT3030 acts as if a diode is in series with its input. No reverse current flows into the LT3030 and no reverse voltage appears at the load. The device protects itself and the load.

**PWRGD1, PWRGD2 (Pins 22, 15/Pins 19, 12):** Power Good. The PWRGD flag is an open-collector flag to indicate that the output voltage has increased above 90% of the nominal output voltage. There is no internal pull-up on this pin; a pull-up resistor must be used. The PWRGD pin

changes state from an open-collector pull-down to high impedance after the output increases above 90% of the nominal voltage. The maximum pull-down current of the PWRGD pin in the low state is  $100\mu\text{A}$ .

**SHDN1, SHDN2 (Pins 23, 14/Pins 20, 11):** Shutdown. Pulling the  $\overline{\text{SHDN1}}$  or  $\overline{\text{SHDN2}}$  pin low puts its corresponding LT3030 channel into a low power state and turns its output off. The  $\overline{\text{SHDN1}}$  and  $\overline{\text{SHDN2}}$  pins are completely independent of each other, and each  $\overline{\text{SHDN}}$  pin only affects operation on its corresponding channel. Drive the  $\overline{\text{SHDN1}}$  and  $\overline{\text{SHDN2}}$  pins with either logic or an open collector/drain with pull-up resistors. The resistors supply the pull-up current to the open collectors/drains and the  $\overline{\text{SHDN1}}$  or  $\overline{\text{SHDN2}}$  current, typically less than  $1\mu\text{A}$ . If unused, connect  $\overline{\text{SHDN1}}$  and  $\overline{\text{SHDN2}}$  to their corresponding IN pins. Each channel will be in its low power shutdown state if its corresponding  $\overline{\text{SHDN}}$  pin is not connected.

**ADJ1, ADJ2 (Pins 27, 10/Pins 1, 10):** Adjust Pin. These are the error amplifier inputs. These pins are internally clamped to  $\pm 9\text{V}$ . A typical input bias current of  $30\text{nA}$  flows into the pins (see curve of ADJ1/ADJ2 Pin Bias Current vs Temperature in the Typical Performance Characteristics section). The ADJ1 and ADJ2 pin voltages are  $1.220\text{V}$  referenced to ground and the output voltage range is  $1.220\text{V}$  to  $19.5\text{V}$ .

**BYP1, BYP2 (Pins 28, 9/Pins 2, 9):** Bypass. Connecting a capacitor between OUT and BYP of a respective channel bypasses the LT3030 reference to achieve low noise performance, improve transient response and soft-start the output. Internal circuitry clamps the BYP1/BYP2 pins to  $\pm 0.6\text{V}$  (one  $V_{\text{BE}}$ ) from ground. A small capacitor from the corresponding output to this pin bypasses the reference to lower the output voltage noise. Using a maximum value of  $10\text{nF}$  reduces the output voltage noise to a typical  $20\mu\text{V}_{\text{RMS}}$  over a  $10\text{Hz}$  to  $100\text{kHz}$  bandwidth. If not used, this pin must be left unconnected.

## APPLICATIONS INFORMATION

The LT3030 is a dual 750mA/250mA low dropout regulator with independent inputs, micropower quiescent current and shutdown. The device supplies up to 750mA/250mA from the outputs of channel 1/channel 2 at a typical dropout voltage of 300mV. The two regulators share common GND pins and are thermally coupled. However, the two inputs and outputs of the LT3030 operate independently. **Each channel can be shut down independently, but a thermal shutdown fault on either channel shuts off the output on both channels.** The addition of a 10nF reference bypass capacitor lowers output voltage noise to 20μV<sub>RMS</sub> over a 10Hz to 100kHz bandwidth. Additionally, the reference bypass capacitor improves transient response of the regulator, lowering the settling time for transient load conditions. The low operating quiescent current (120μA/75μA for channel 1/2) drops to typically less than 1μA in shutdown. In addition to the low quiescent current, the LT3030 regulator incorporates several protection features that make it ideal for use in battery powered systems. Most importantly, the device protects itself against reverse input voltages.

### Adjustable Operation

Each of the LT3030's channels has an output voltage range of 1.220V to 19.5V. Figure 1 illustrates that the output voltage is set by the ratio of two external resistors. The device regulates the output to maintain the corresponding ADJ pin voltage at 1.220V referenced to ground. R1's current equals 1.220V/R1. R2's current equals R1's current plus the ADJ pin bias current. The ADJ pin bias current, 30nA at 25°C, flows through R2 into the ADJ pin. Use the formula in Figure 1 to calculate output voltage. Linear Technology recommends that the value of R1 be less than 243k to minimize errors in the output voltage due to the ADJ pin bias current. In shutdown, the output turns off and the divider current is zero. Curves of ADJ Pin Voltage vs Temperature and ADJ Pin Bias Current vs Temperature appear in the Typical Performance Characteristics section.

Linear Technology tests and specifies each LT3030 channel with its ADJ pin tied to the corresponding OUT pin for a 1.220V output voltage. Specifications for output voltages greater than 1.220V are proportional to the ratio of desired output voltage to 1.220V:

$$V_{OUT}/1.220V$$

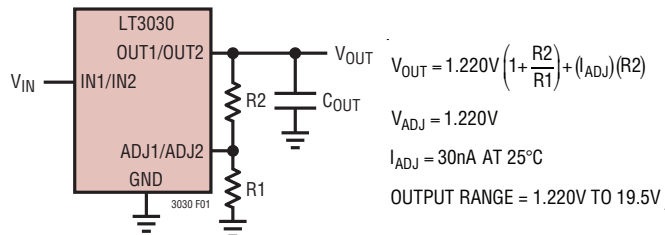

Figure 1. Adjustable Operation

For example, load regulation on OUT2 for an output current change of 1mA to full load current is typically -2mV at  $V_{OUT2} = 1.220V$ . At  $V_{OUT2} = 2.5V$ , load regulation is:

$$(2.5V/1.220V) \cdot (-2mV) = -4.1mV$$

Table 1 shows 1% resistor divider values for some common output voltages with a resistor divider current of approximately 5μA.

Table 1. Output Voltage Resistor Divider Values

V <sub>OUT</sub> (V)	R1 (k)	R2 (k)
1.5	237	54.9
1.8	237	113
2.5	243	255
3	232	340
3.3	210	357
5	200	619

### Bypass Capacitance and Low Noise Performance

Using a bypass capacitor connected between a channel's BYP pin and its corresponding OUT pin significantly lowers LT3030 output voltage noise, but is not required in all applications. Linear Technology recommends a good quality low leakage capacitor. This capacitor bypasses the regulator's reference, providing a low frequency noise pole. A 10nF bypass capacitor introduces a noise pole that decreases output voltage noise to as low as 20μV<sub>RMS</sub>. Using a bypass capacitor provides the added benefit of improving transient response. With no bypass capacitor and a 10μF output capacitor, a 100mA to full load step settles to within 1% of its final value in approximately 400μs. With the addition of a 10nF bypass capacitor and evaluating the same load step, output voltage excursion stays within 2% (see Transient Response in the Typical Performance Characteristics section). Using a bypass capacitor makes regulator start-up time proportional to the value of the bypass capacitor. For example, a 10nF bypass capacitor and 10μF output capacitor slow start-up time to 15ms.

3030f

## APPLICATIONS INFORMATION

### Input Capacitance and Stability

Each LT3030 channel is stable with an input capacitor typically between  $1\mu\text{F}$  and  $10\mu\text{F}$ . Applications operating with smaller  $V_{\text{IN}}$  to  $V_{\text{OUT}}$  differential voltages and that experience large load transients may require a higher input capacitor value to prevent input voltage droop and letting the regulator enter dropout.

Very low ESR ceramic capacitors may be used. However, in cases where long wires connect the power supply to the LT3030's input and ground, use of low value input capacitors combined with an output load current of greater than  $20\text{mA}$  may result in instability. The resonant LC tank circuit formed by the wire inductance and the input capacitor is the cause and not a result of LT3030 instability.

The self-inductance, or isolated inductance, of a wire is directly proportional to its length. However, the wire diameter has less influence on its self inductance. For example, the self-inductance of a 2-AWG isolated wire with a diameter of  $0.26''$  is about half the inductance of a 30-AWG wire with a diameter of  $0.01''$ . One foot of 30-AWG wire has  $465\text{nH}$  of self-inductance.

Several methods exist to reduce a wire's self-inductance. One method divides the current flowing towards the LT3030 between two parallel conductors. In this case, placing the wires further apart reduces the inductance; up to a 50% reduction when placed only a few inches apart. Splitting the wires connects two equal inductors in parallel. However, when placed in close proximity to each other, mutual inductance adds to the overall self inductance of the wires. The most effective technique to reducing overall inductance is to place the forward and return current conductors (the input wire and the ground wire) in close proximity. Two 30-AWG wires separated by  $0.02''$  reduce the overall self inductance to about one-fifth of a single wire.

If a battery, mounted in close proximity, powers the LT3030, a  $1\mu\text{F}$  input capacitor suffices for stability. However, if a distantly located supply powers the LT3030, use a larger value input capacitor. Use a rough guideline of  $1\mu\text{F}$  (in addition to the  $1\mu\text{F}$  minimum) per 8 inches of wire length. The minimum input capacitance needed to stabilize the application also varies with power supply output impedance variations. Placing additional capacitance on the

LT3030's output also helps. However, this requires an order of magnitude more capacitance in comparison with additional LT3030 input bypassing. Series resistance between the supply and the LT3030 input also helps stabilize the application; as little as  $0.1\Omega$  to  $0.5\Omega$  suffices. This impedance dampens the LC tank circuit at the expense of dropout voltage. A better alternative is to use higher ESR tantalum or electrolytic capacitors at the LT3030 input in place of ceramic capacitors.

### Output Capacitance and Transient Response

The LT3030 is stable with a wide range of output capacitors. The ESR of the output capacitor affects stability, most notably with small capacitors. Linear Technology recommends a minimum output capacitor of  $10\mu\text{F}/3.3\mu\text{F}$  (channel 1 /channel 2) with an ESR of  $3\Omega$ , or less, to prevent oscillations. The LT3030 is a micropower device, and output transient response is a function of output capacitance. Larger values of output capacitance decrease the peak deviations and provide improved transient response for larger load current changes.

Ceramic capacitors require extra consideration. Manufacturers make ceramic capacitors with a variety of dielectrics, each with different behavior across temperature and applied voltage. The most common dielectrics specify the EIA temperature characteristic codes of Z5U, Y5V, X5R and X7R. Z5U and Y5V dielectrics provide high C-V products in a small package at low cost, but exhibit strong voltage and temperature coefficients, as shown in Figure 2 and Figure 3. When used with a 5V regulator, a  $16\text{V } 10\mu\text{F } \text{Y5V}$  capacitor can exhibit an effective value as low as  $1\mu\text{F}$  to  $2\mu\text{F}$  for the applied DC bias voltage and over the operating temperature range. X5R and X7R dielectrics result in more stable characteristics and are more suitable for use as the output capacitor. The X7R type has better stability across temperature, while the X5R is less expensive and is available in higher values.

Exercise care even when using X5R and X7R capacitors; the X5R and X7R codes only specify operating temperature range and maximum capacitance change over temperature. Capacitance change due to DC bias (voltage coefficient) with X5R and X7R capacitors is better than with Y5V and Z5U capacitors, but can still be significant enough to drop

## APPLICATIONS INFORMATION

capacitor values below appropriate levels. Capacitor DC bias characteristics tend to improve as case size increases. Linear Technology recommends verifying expected versus actual capacitance values at operating voltage in situ for an application.

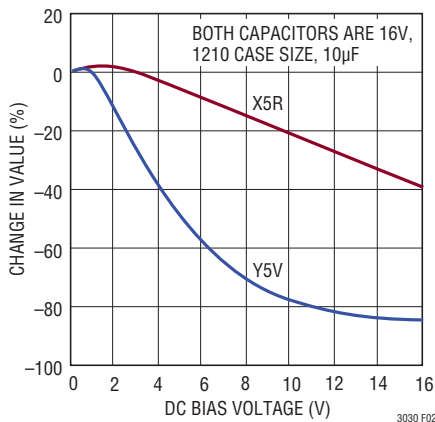

**Figure 2. Ceramic Capacitor DC Bias Characteristics**

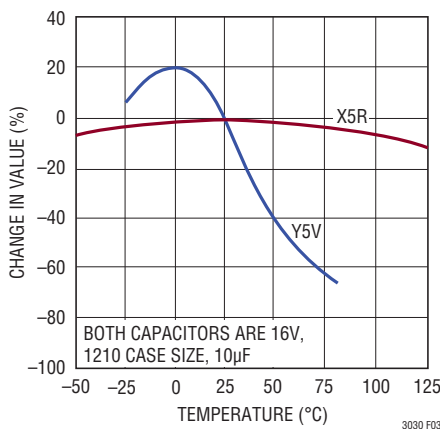

**Figure 3. Ceramic Capacitor Temperature Characteristics**

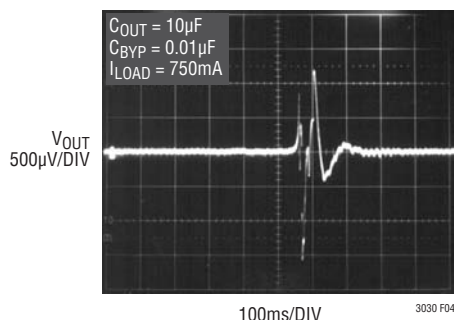

**Figure 4. Noise Resulting from Tapping on a Ceramic Capacitor**

Voltage and temperature coefficients are not the only sources of problems. Some ceramic capacitors have a piezoelectric response. A piezoelectric device generates voltage across its terminals due to mechanical stress, similar to the way a piezoelectric accelerometer or microphone works. For a ceramic capacitor, the stress can be induced by vibrations in the system or thermal transients. The resulting voltages produced can cause appreciable amounts of noise, especially when a ceramic capacitor is used for noise bypassing. A ceramic capacitor produced the trace's response to light tapping from a pencil, as shown in Figure 4. Similar vibration induced behavior can masquerade as increased output voltage noise.

### Shutdown/UVLO

The  $\overline{\text{SHDN}}$  pin is used to put the LT3030 into a micropower shutdown state. The LT3030 has an accurate 1.21V threshold (during turn-on) on the  $\overline{\text{SHDN}}$  pin. This threshold can be used in conjunction with a resistor divider from the system input supply to define an accurate undervoltage lockout (UVLO) threshold for the regulator. The  $\overline{\text{SHDN}}$  pin current (at the threshold) needs to be considered when determining the resistor divider network.

### PWRGD Flag

The PWRGD flag indicates that the ADJ pin voltage is within 10% of the regulated voltage. The PWRGD pin is an open-collector output, capable of sinking 100µA of current when the ADJ pin voltage is below 90% of the regulated voltage. There is no internal pull-up on the PWRGD pin; an external pull-up resistor must be used. As the ADJ pin voltage rises above 90% of its regulated voltage, the PWRGD pin switches to a high impedance state and the external pull-up resistor pulls the PWRGD pin voltage up. During normal operation, an internal glitch filter prevents the PWRGD pin from switching to a low voltage state if the ADJ pin voltage falls below the regulated voltage by more than 10% in a short transient (<40µs typical) event.

### Thermal Considerations

The LT3030's power handling capability limits the maximum rated junction temperature (125°C, LT3030E/LT3030I or 150°C, LT3030H/LT3030MP). Two components comprise the power dissipated by each channel:

## APPLICATIONS INFORMATION

1. Output current multiplied by the input/output voltage differential:  $(I_{OUT})(V_{IN} - V_{OUT})$ , and
2. GND pin current multiplied by the input voltage:  $(I_{GND})(V_{IN})$ .

Ground pin current is found by examining the GND Pin Current curves in the Typical Performance Characteristics section.

Power dissipation for each channel equals the sum of the two components listed above. Total power dissipation for the LT3030 equals the sum of the power dissipated by each channel.

**The LT3030's internal thermal shutdown circuitry protects both channels of the device if either channel experiences an overload or fault condition. Activation of the thermal shutdown circuitry turns both channels off. If the overload or fault condition is removed, both outputs are allowed to turn back on. For continuous normal conditions, do not exceed the maximum junction temperature rating of 125°C (LT3030E/LT3030I) or 150°C (LT3030H/LT3030MP).**

Carefully consider all sources of thermal resistance from junction-to-ambient, including additional heat sources mounted in proximity to the LT3030. For surface mount devices, use the heat spreading capabilities of the PC board and its copper traces to accomplish heat sinking. Copper board stiffeners and plated through-holes can also spread the heat generated by power devices.

The following tables list thermal resistance as a function of copper area in a fixed board size. All measurements were taken in still air on a four-layer FR-4 board with 1oz solid internal planes, and 2oz external trace planes with a total board thickness of 1.6mm. For further information on thermal resistance and using thermal information, refer to JEDEC standard JESD51, notably JESD 51-7 and JESD 51-12.

**Table 2. UFD Package, 28-Lead QFN**

COPPER AREA		BOARD AREA	THERMAL RESISTANCE (JUNCTION-TO-AMBIENT)
TOPSIDE*	BACKSIDE		
2500mm <sup>2</sup>	2500mm <sup>2</sup>	2500mm <sup>2</sup>	30°C/W
1000mm <sup>2</sup>	2500mm <sup>2</sup>	2500mm <sup>2</sup>	32°C/W
225mm <sup>2</sup>	2500mm <sup>2</sup>	2500mm <sup>2</sup>	33°C/W
100mm <sup>2</sup>	2500mm <sup>2</sup>	2500mm <sup>2</sup>	35°C/W

\*Device is mounted on topside.

**Table 3. FE Package, 20-Lead TSSOP**

COPPER AREA		BOARD AREA	THERMAL RESISTANCE (JUNCTION-TO-AMBIENT)
TOPSIDE*	BACKSIDE		
2500mm <sup>2</sup>	2500mm <sup>2</sup>	2500mm <sup>2</sup>	25°C/W
1000mm <sup>2</sup>	2500mm <sup>2</sup>	2500mm <sup>2</sup>	27°C/W
225mm <sup>2</sup>	2500mm <sup>2</sup>	2500mm <sup>2</sup>	28°C/W
100mm <sup>2</sup>	2500mm <sup>2</sup>	2500mm <sup>2</sup>	32°C/W

\*Device is mounted on topside.

The junction-to-case thermal resistance ( $\theta_{JC}$ ), measured at the exposed pad on the back of the die, is 3.4°C/W for the QFN package, and 10°C/W for the TSSOP package.

### Calculating Junction Temperature

Example: Channel 1's output voltage is set to 1.8V. Channel 2's output voltage is set to 1.5V. Each channel's input voltage is 2.5V. Channel 1's output current range is 0mA to 750mA. Channel 2's output current range is 0mA to 250mA. The application has a maximum ambient temperature of 50°C. What is the LT3030's maximum junction temperature?

The power dissipated by each channel equals:

$$I_{OUT(MAX)}(V_{IN} - V_{OUT}) + I_{GND}(V_{IN})$$

where for output 1:

$$\begin{aligned} I_{OUT(MAX)} &= 750\text{mA} \\ V_{IN} &= 2.5\text{V} \\ I_{GND} \text{ at } (I_{OUT} = 750\text{mA}, V_{IN} = 2.5\text{V}) &= 13\text{mA} \end{aligned}$$

For output 2:

$$\begin{aligned} I_{OUT(MAX)} &= 250\text{mA} \\ V_{IN} &= 2.5\text{V} \\ I_{GND} \text{ at } (I_{OUT} = 250\text{mA}, V_{IN} = 2.5\text{V}) &= 4.5\text{mA} \end{aligned}$$

So, for output 1:

$$P = 750\text{mA} (2.5\text{V} - 1.8\text{V}) + 13\text{mA} (2.5\text{V}) = 0.56\text{W}$$

For output 2:

$$P = 250\text{mA} (2.5\text{V} - 1.5\text{V}) + 4.5\text{mA} (2.5\text{V}) = 0.26\text{W}$$

The thermal resistance is in the range of 25°C/W to 35°C/W, depending on the copper area. So, the junction temperature rise above ambient temperature approximately equals:

$$(0.56\text{W} + 0.26\text{W}) 30^\circ\text{C/W} = 24.6^\circ\text{C}$$

## APPLICATIONS INFORMATION

The maximum junction temperature then equals the maximum ambient temperature plus the maximum junction temperature rise above ambient temperature, or:

$$T_{JMAX} = 50^{\circ}\text{C} + 24.6^{\circ}\text{C} = 74.6^{\circ}\text{C}$$

### Protection Features

The LT3030 regulator incorporates several protection features that make it ideal for use in battery-powered circuits. In addition to the normal protection features associated with monolithic regulators, such as current limiting and thermal limiting, the device protects itself against reverse input voltages and reverse voltages from output to input. The two regulators have independent inputs, a common GND pin and are thermally coupled. However, the two channels of the LT3030 operate independently. Each channel's output can be shut down independently, and a fault condition on one output does not affect the other output electrically, unless the thermal shutdown circuitry is activated.

Current limit protection and thermal overload protection protect the device against current overload conditions at each output of the LT3030. For normal operation, do not allow the junction temperature to exceed 125°C (LT3030E/LT3030I) or 150°C (LT3030H/LT3030MP). The typical thermal shutdown temperature threshold is 165°C and the circuitry incorporates approximately 5°C of hysteresis.

Each channel's input withstands reverse voltages of 22V. Current flow into the device is limited to less than 1mA (typically less than 100µA) and no negative voltage appears at the respective channel's output. The device protects both itself and the load against batteries that are plugged in backwards.

The LT3030 incurs no damage if either channel's output is pulled below ground. If the input is left open-circuit, or grounded, the output can be pulled below ground by 22V. The output acts like an open circuit, and no current flows from the output. However, current flows in (but is limited by) the external resistor divider that sets the output voltage. If the input is powered by a voltage source, the output sources current equal to its current limit capability and the LT3030 protects itself by its thermal limiting circuitry. In this case, grounding the relevant SHDN1 or SHDN2 pin turns off its channel's output and stops that output from sourcing current.

The LT3030 incurs no damage if either ADJ pin is pulled above or below ground by 9V. If the input is left open circuit or grounded, the ADJ pins perform like an open circuit down to -1.5V, and then like a 1.2k resistor down to -9V when pulled below ground. When pulled above ground, the ADJ pins perform like an open circuit up to 0.5V, then like a 5.7k resistor up to 3V, then like a 1.8k resistor up to 9V.

In situations where an ADJ pin connects to a resistor divider that would pull the pin above its 9V clamp voltage if the output is pulled high, the ADJ pin input current must be limited to less than 5mA. For example, assume a resistor divider sets the regulated output voltage to 1.5V, and the output is forced to 20V. The top resistor of the resistor divider must be chosen to limit the current into the ADJ pin to less than 5mA when the ADJ pin is at 9V. The 11V difference between the OUT and ADJ pins divided by the 5mA maximum current into the ADJ pin yields a minimum top resistor value of 2.2k.

In circuits where a backup battery is required, several different input/output conditions can occur. The output voltage may be held up while the input is either pulled to ground, pulled to some intermediate voltage or is left open-circuit. Current flow back into the output follows the curve shown in Figure 5.

If either of the LT3030's IN pins is forced below its corresponding OUT pin, or the OUT pin is pulled above its corresponding IN pin, input current for that channel typically

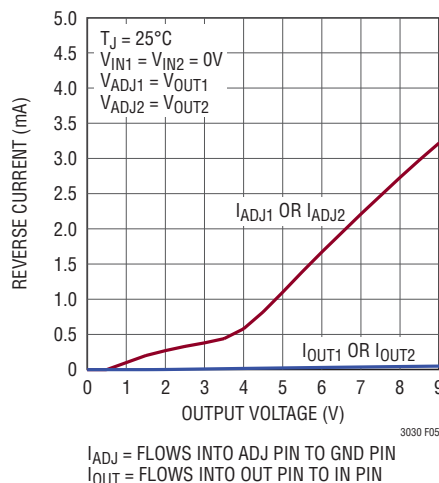

Figure 5. Reverse Output Current



## APPLICATIONS INFORMATION

drops to less than  $2\mu\text{A}$ . This occurs if the IN pin is connected to a discharged (low voltage) battery, and either a backup battery or a second regulator circuit holds up the output. The state of that channel's  $\overline{\text{SHDN}}$  pin has no effect on the reverse output current if the output is pulled above the input.

### Overload Recovery

Like many IC power regulators, the LT3030 has safe operating area (SOA) protection. The safe area protection decreases current limit as input-to-output voltage increases and keeps the power transistor inside a safe operating region for all values of input-to-output voltage. The protective design provides some output current at all values of input-to-output voltage up to the specified maximum operational input voltage of 20V.

When power is first applied, as input voltage rises, the output follows the input, allowing the regulator to start-up into heavy loads. During start-up, as the input voltage is rising, the input-to-output voltage differential is small, allowing the regulator to supply large output currents. With a high input voltage, an event can occur wherein removal of an output short will not allow the output to recover. The event occurs with a heavy output load when the input voltage is high and the output voltage is low. Common situations occur immediately after the removal of a short-circuit or if the shutdown pin is pulled high after the input voltage has already been turned on. The load line intersects the output current curve at two points creating two stable output operating points for the regulator. With this double intersection, the input power supply may need to be cycled down to zero and brought up again to make the output recover.

## TYPICAL APPLICATIONS

Coincident Tracking Supply Application

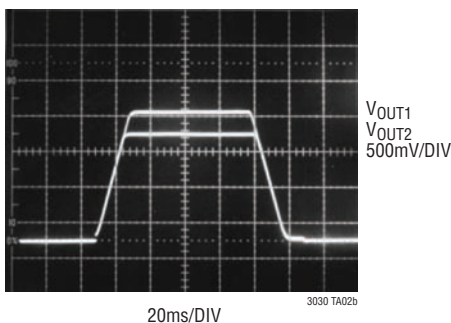
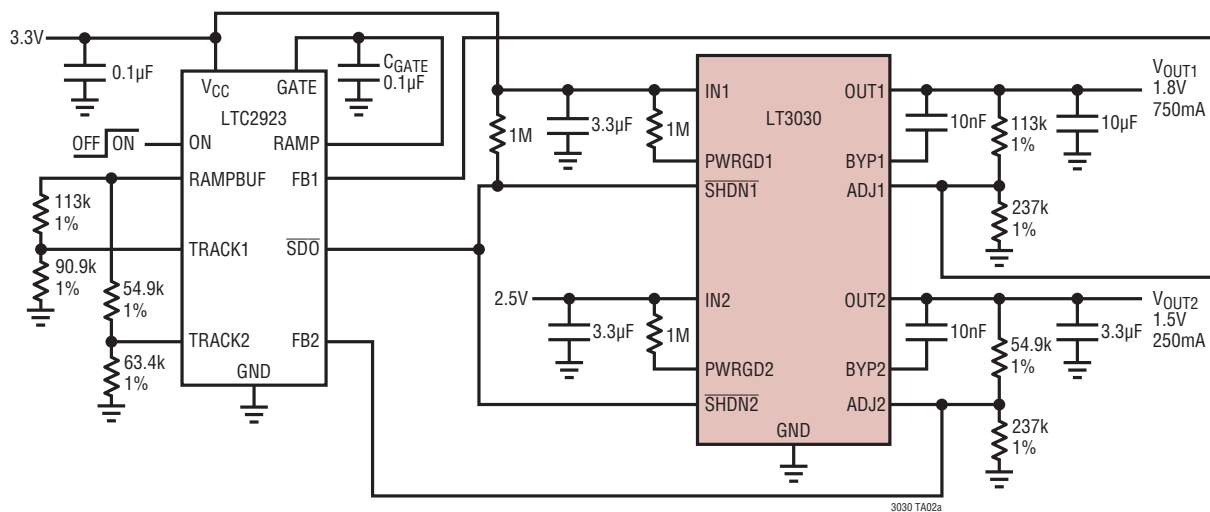

## PACKAGE DESCRIPTION

Please refer to <http://www.linear.com/designtools/packaging/> for the most recent package drawings.

**UFD Package**  
**28-Lead (4mm × 5mm) Plastic QFN**  
 (Reference LTC DWG # 05-08-1712 Rev B)

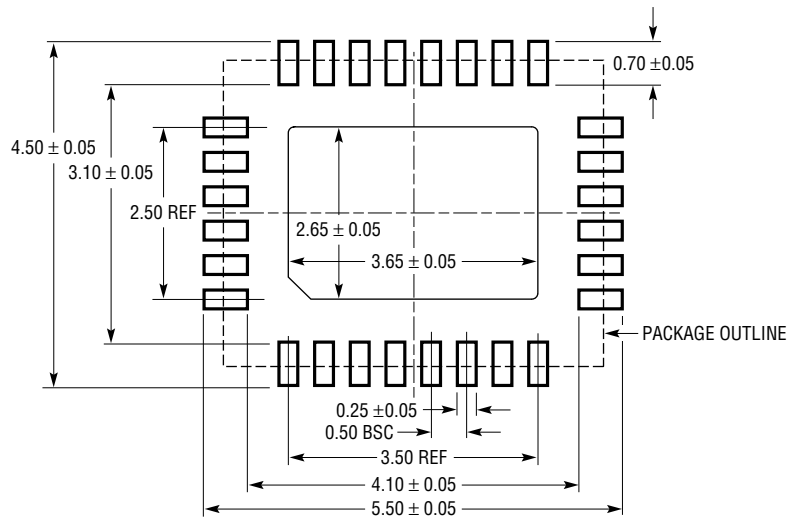

RECOMMENDED SOLDER PAD PITCH AND DIMENSIONS  
 APPLY SOLDER MASK TO AREAS THAT ARE NOT SOLDERED

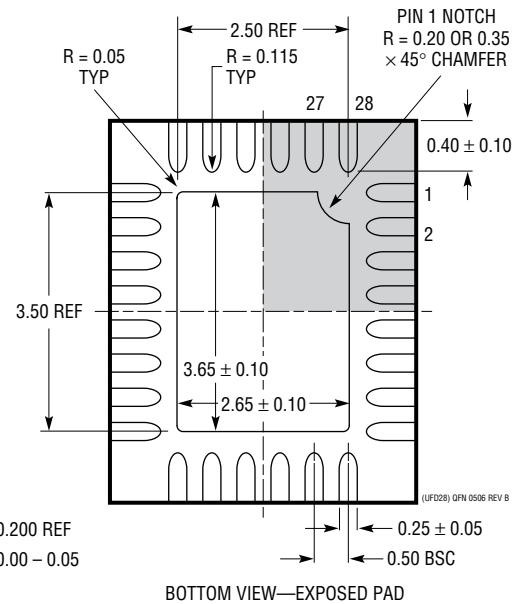
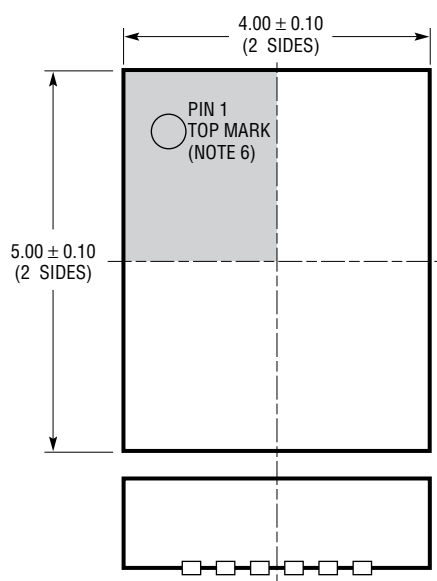

**NOTE:**

1. DRAWING PROPOSED TO BE MADE A JEDEC PACKAGE OUTLINE MO-220 VARIATION (WXXX-X).
2. DRAWING NOT TO SCALE
3. ALL DIMENSIONS ARE IN MILLIMETERS
4. DIMENSIONS OF EXPOSED PAD ON BOTTOM OF PACKAGE DO NOT INCLUDE MOLD FLASH. MOLD FLASH, IF PRESENT, SHALL NOT EXCEED 0.15mm ON ANY SIDE
5. EXPOSED PAD SHALL BE SOLDER PLATED
6. SHADED AREA IS ONLY A REFERENCE FOR PIN 1 LOCATION ON THE TOP AND BOTTOM OF PACKAGE

# PACKAGE DESCRIPTION

Please refer to <http://www.linear.com/designtools/packaging/> for the most recent package drawings.

**FE Package**  
**20-Lead Plastic TSSOP (4.4mm)**  
 (Reference LTC DWG # 05-08-1663 Rev J)

**Exposed Pad Variation CB**

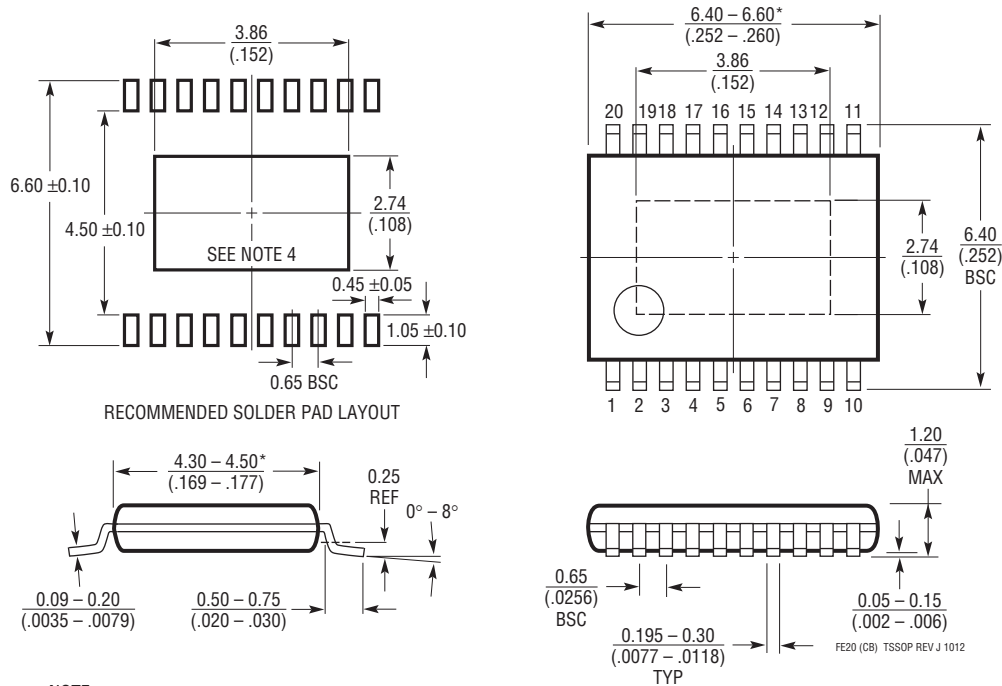

- NOTE:
1. CONTROLLING DIMENSION: MILLIMETERS
  2. DIMENSIONS ARE IN  $\frac{\text{MILLIMETERS}}{\text{(INCHES)}}$
  3. DRAWING NOT TO SCALE
  4. RECOMMENDED MINIMUM PCB METAL SIZE FOR EXPOSED PAD ATTACHMENT
- \*DIMENSIONS DO NOT INCLUDE MOLD FLASH. MOLD FLASH SHALL NOT EXCEED 0.150mm (.006") PER SIDE

## TYPICAL APPLICATION

### Sequencing Supply Application

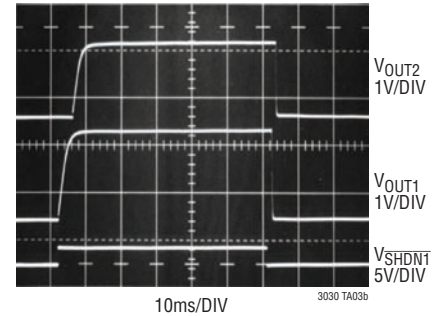
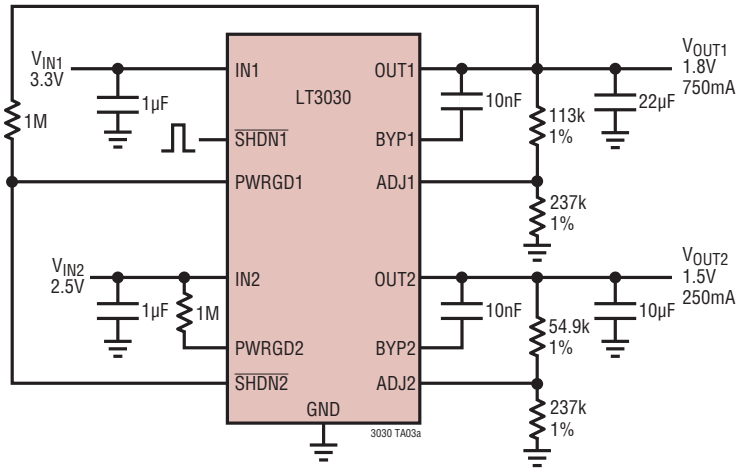

## RELATED PARTS

PART NUMBER	DESCRIPTION	COMMENTS
LT1761	100mA, Low Noise Micropower LDO	$V_{IN}$ : 1.8V to 20V, $V_{OUT}$ = 1.22V, $V_{DO}$ = 0.3V, $I_Q$ = 20 $\mu$ A, $I_{SD}$ < 1 $\mu$ A, Low Noise < 20 $\mu$ V <sub>RMS</sub> , Stable with 1 $\mu$ F Ceramic Capacitors, ThinSOT™ Package
LT1763	500mA, Low Noise Micropower LDO	$V_{IN}$ : 1.8V to 20V, $V_{OUT}$ = 1.22V, $V_{DO}$ = 0.3V, $I_Q$ = 30 $\mu$ A, $I_{SD}$ < 1 $\mu$ A, Low Noise < 20 $\mu$ V <sub>RMS</sub> , S8 Package
LT1963/ LT1963A	1.5A, Low Noise, Fast Transient Response LDOs	$V_{IN}$ : 2.1V to 20V, $V_{OUT(MIN)}$ = 1.21V, $V_{DO}$ = 0.34V, $I_Q$ = 1mA, $I_{SD}$ < 1 $\mu$ A, Low Noise: < 40 $\mu$ V <sub>RMS</sub> , "A" Version Stable with Ceramic Capacitors, DD, TO220-5, SOT223, S8 Packages
LT1964	200mA, Low Noise Micropower, Negative LDO	$V_{IN}$ : -2.2V to -20V, $V_{OUT(MIN)}$ = 1.21V, $V_{DO}$ = 0.34V, $I_Q$ = 30 $\mu$ A, $I_{SD}$ = 3 $\mu$ A, Low Noise: < 30 $\mu$ V <sub>RMS</sub> , Stable with Ceramic Capacitors, ThinSOT Package
LT1965	1.1A, Low Noise, Fast Transient Response LDO	$V_{IN}$ : 1.8V to 20V, $V_{OUT(MIN)}$ = 1.20V, $V_{DO}$ = 0.3V, $I_Q$ = 0.5mA, $I_{SD}$ < 1 $\mu$ A, Low Noise: < 40 $\mu$ V <sub>RMS</sub> , Stable with Ceramic Capacitors, 3mm x 3mm DFN, MS8E, DD-Pak, TO-220 Packages
LT3023	Dual 100mA, Low Noise, Micropower LDO	$V_{IN}$ : 1.8V to 20V, $V_{OUT(MIN)}$ = 1.22V, $V_{DO}$ = 0.30V, $I_Q$ = 40 $\mu$ A, $I_{SD}$ < 1 $\mu$ A, DFN, MS10 Packages
LT3024	Dual 100mA/500mA, Low Noise, Micropower LDO	$V_{IN}$ : 1.8V to 20V, $V_{OUT(MIN)}$ = 1.22V, $V_{DO}$ = 0.30V, $I_Q$ = 60 $\mu$ A, $I_{SD}$ < 1 $\mu$ A, DFN, TSSOP-16E Packages
LT3027	Dual 100mA, Low Noise, Micropower LDO with Independent Inputs	$V_{IN}$ : 1.8V to 20V, $V_{OUT(MIN)}$ = 1.22V, $V_{DO}$ = 0.30V, $I_Q$ = 40 $\mu$ A, $I_{SD}$ < 1 $\mu$ A, DFN, MS10E Packages
LT3028	Dual 100mA/500mA, Low Noise, Micropower LDO with Independent Inputs	$V_{IN}$ : 1.8V to 20V, $V_{OUT(MIN)}$ = 1.22V, $V_{DO}$ = 0.30V, $I_Q$ = 60 $\mu$ A, $I_{SD}$ < 1 $\mu$ A, DFN, TSSOP-16E Packages
LT3029	Dual 500mA/500mA, Low Noise, Micropower LDO with Independent Inputs	$V_{IN}$ : 1.8V to 20V, $V_{OUT(MIN)}$ = 1.215V, $V_{DO}$ = 0.30V, $I_Q$ = 55 $\mu$ A, $I_{SD}$ < 1 $\mu$ A, DFN, MSOP-16E Packages
LT3032	Dual 150mA Positive/Negative Low Noise, Low Dropout Linear Regulator	$V_{IN}$ : $\pm$ 2.3V to $\pm$ 20V, $V_{OUT(MIN)}$ = $\pm$ 1.22V, $V_{DO}$ = 0.30V, $I_Q$ = 30 $\mu$ A, $I_{SD}$ < 1 $\mu$ A, 14-Lead DFN Package
LT3080/ LT3080-1	1.1A, Parallelable, Low Noise LDO	300mV Dropout Voltage (2-Supply Operation), Low Noise 40 $\mu$ V <sub>RMS</sub> , $V_{IN}$ = 1.2V to 36V, $V_{OUT}$ : 0V to 35.7V, Current-Based Reference with 1-Resistor $V_{OUT}$ Set, Directly Parallelable (No Op Amp Required), Stable with Ceramic Capacitors, TO-220, SOT-223, MSOP and 3mm x 3mm DFN