

FEATURES

- **Low Noise:** 20 μ V_{RMS} (10Hz to 100kHz)
- **Output Current:** 500mA
- **Low Quiescent Current:** 30 μ A
- **Wide Input Voltage Range:** 1.8V to 20V
- **Low Dropout Voltage:** 300mV
- **Very Low Shutdown Current:** < 1 μ A
- No Protection Diodes Needed
- Fixed Output Voltages: 1.5V, 1.8V, 2.5V, 3V, 3.3V, 5V
- Adjustable Output from 1.22V to 20V
- Stable with 3.3 μ F Output Capacitor
- Stable with Aluminum, Tantalum or Ceramic Capacitors
- Reverse Battery Protection
- No Reverse Current
- Overcurrent and Overtemperature Protected
- 8-Lead SO and 12-Lead (4mm × 3mm) DFN Packages

APPLICATIONS

- Cellular Phones
- Battery-Powered Systems
- Noise-Sensitive Instrumentation Systems

DESCRIPTION

The LT[®]1763 series are micropower, low noise, low dropout regulators. The devices are capable of supplying 500mA of output current with a dropout voltage of 300mV. Designed for use in battery-powered systems, the low 30 μ A quiescent current makes them an ideal choice. Quiescent current is well controlled; it does not rise in dropout as it does with many other regulators.

A key feature of the LT1763 regulators is low output noise. With the addition of an external 0.01 μ F bypass capacitor, output noise drops to 20 μ V_{RMS} over a 10Hz to 100kHz bandwidth. The LT1763 regulators are stable with output capacitors as low as 3.3 μ F. Small ceramic capacitors can be used without the series resistance required by other regulators.

Internal protection circuitry includes reverse battery protection, current limiting, thermal limiting and reverse current protection. The parts come in fixed output voltages of 1.5V, 1.8V, 2.5V, 3V, 3.3V and 5V, and as an adjustable device with a 1.22V reference voltage. The LT1763 regulators are available in 8-lead SO and 12-lead, low profile (4mm × 3mm × 0.75mm) DFN packages.

LT, LT, LTC, LTM, Linear Technology and the Linear logo are registered trademarks and ThinSOT is a trademark of Linear Technology Corporation. All other trademarks are the property of their respective owners. Protected by U.S. Patents including 6144250, 6118263.

TYPICAL APPLICATION

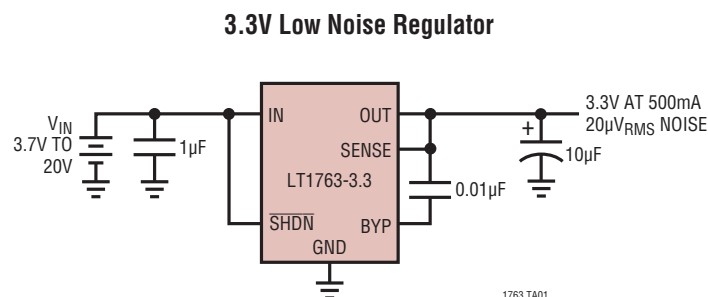

Dropout Voltage

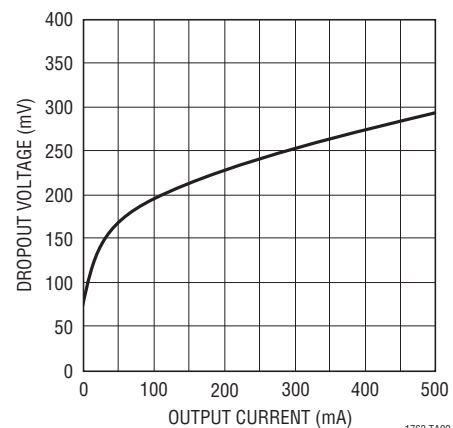

LT1763 Series

ABSOLUTE MAXIMUM RATINGS (Note 1)

| | | | |
|---|------------|---|----------------|
| IN Pin Voltage | ±20V | Operating Junction Temperature Range (Note 2) | |
| OUT Pin Voltage | ±20V | C, I Grade..... | –40°C to 125°C |
| Input to Output Differential Voltage..... | ±20V | MP Grade..... | –55°C to 125°C |
| SENSE Pin Voltage | ±20V | Storage Temperature Range | |
| ADJ Pin Voltage | ±7V | S8 Package | –65°C to 150°C |
| BYP Pin Voltage | ±0.6V | DFN Package..... | –65°C to 150°C |
| SHDN Pin Voltage | ±20V | Lead Temperature (Soldering, 10 sec) | |
| Output Short-Circuit Duration | Indefinite | S8 Package | 300°C |

PIN CONFIGURATION

TOP VIEW

DE PACKAGE
12-LEAD (4mm × 3mm) PLASTIC DFN

$T_{JMAX} = 125^{\circ}\text{C}$, $\theta_{JA} = 40^{\circ}\text{C/W}$, $\theta_{JC} = 5^{\circ}\text{C/W}$
EXPOSED PAD (PIN 13) IS GND, MUST BE SOLDERED TO PCB

*PIN 5: SENSE FOR LT1763-1.5/LT1763-1.8/LT1763-2.5/LT1763-3/LT1763-3.3/LT1763-5
ADJ FOR LT1763

SEE THE APPLICATIONS INFORMATION SECTION.

TOP VIEW

S8 PACKAGE
8-LEAD PLASTIC SO

$T_{JMAX} = 150^{\circ}\text{C}$, $\theta_{JA} = 70^{\circ}\text{C/W}$, $\theta_{JC} = 35^{\circ}\text{C/W}$

*PIN 2: SENSE FOR LT1763-1.5/LT1763-1.8/LT1763-2.5/LT1763-3/LT1763-3.3/LT1763-5
ADJ FOR LT1763

SEE THE APPLICATIONS INFORMATION SECTION.

ORDER INFORMATION

| LEAD FREE FINISH | TAPE AND REEL | PART MARKING* | PACKAGE DESCRIPTION | TEMPERATURE RANGE |
|--------------------|----------------------|---------------|---------------------------------|-------------------|
| LT1763CDE#PBF | LT1763CDE#TRPBF | 1763 | 12-Lead (4mm × 3mm) Plastic DFN | –40°C to 125°C |
| LT1763IDE#PBF | LT1763IDE#TRPBF | 1763 | 12-Lead (4mm × 3mm) Plastic DFN | –40°C to 125°C |
| LT1763MPDE#PBF | LT1763MPDE#TRPBF | 1763 | 12-Lead (4mm × 3mm) Plastic DFN | –55°C to 125°C |
| LT1763CDE-1.5#PBF | LT1763CDE-1.5#TRPBF | 76315 | 12-Lead (4mm × 3mm) Plastic DFN | –40°C to 125°C |
| LT1763IDE-1.5#PBF | LT1763IDE-1.5#TRPBF | 76315 | 12-Lead (4mm × 3mm) Plastic DFN | –40°C to 125°C |
| LT1763MPDE-1.5#PBF | LT1763MPDE-1.5#TRPBF | 76315 | 12-Lead (4mm × 3mm) Plastic DFN | –55°C to 125°C |
| LT1763CDE-1.8#PBF | LT1763CDE-1.8#TRPBF | 76318 | 12-Lead (4mm × 3mm) Plastic DFN | –40°C to 125°C |
| LT1763IDE-1.8#PBF | LT1763IDE-1.8#TRPBF | 76318 | 12-Lead (4mm × 3mm) Plastic DFN | –40°C to 125°C |
| LT1763MPDE-1.8#PBF | LT1763MPDE-1.8#TRPBF | 76318 | 12-Lead (4mm × 3mm) Plastic DFN | –55°C to 125°C |
| LT1763CDE-2.5#PBF | LT1763CDE-2.5#TRPBF | 76325 | 12-Lead (4mm × 3mm) Plastic DFN | –40°C to 125°C |
| LT1763IDE-2.5#PBF | LT1763IDE-2.5#TRPBF | 76325 | 12-Lead (4mm × 3mm) Plastic DFN | –40°C to 125°C |
| LT1763MPDE-2.5#PBF | LT1763MPDE-2.5#TRPBF | 76325 | 12-Lead (4mm × 3mm) Plastic DFN | –55°C to 125°C |

1763fg

ORDER INFORMATION

| LEAD FREE FINISH | TAPE AND REEL | PART MARKING* | PACKAGE DESCRIPTION | TEMPERATURE RANGE |
|--------------------|----------------------|---------------|---------------------------------|-------------------|
| LT1763CDE-3#PBF | LT1763CDE-3#TRPBF | 17633 | 12-Lead (4mm × 3mm) Plastic DFN | -40°C to 125°C |
| LT1763IDE-3#PBF | LT1763IDE-3#TRPBF | 17633 | 12-Lead (4mm × 3mm) Plastic DFN | -40°C to 125°C |
| LT1763MPDE-3#PBF | LT1763MPDE-3#TRPBF | 17633 | 12-Lead (4mm × 3mm) Plastic DFN | -55°C to 125°C |
| LT1763CDE-3.3#PBF | LT1763CDE-3.3#TRPBF | 76333 | 12-Lead (4mm × 3mm) Plastic DFN | -40°C to 125°C |
| LT1763IDE-3.3#PBF | LT1763IDE-3.3#TRPBF | 76333 | 12-Lead (4mm × 3mm) Plastic DFN | -40°C to 125°C |
| LT1763MPDE-3.3#PBF | LT1763MPDE-3.3#TRPBF | 76333 | 12-Lead (4mm × 3mm) Plastic DFN | -55°C to 125°C |
| LT1763CDE-5#PBF | LT1763CDE-5#TRPBF | 17635 | 12-Lead (4mm × 3mm) Plastic DFN | -40°C to 125°C |
| LT1763IDE-5#PBF | LT1763IDE-5#TRPBF | 17635 | 12-Lead (4mm × 3mm) Plastic DFN | -40°C to 125°C |
| LT1763MPDE-5#PBF | LT1763MPDE-5#TRPBF | 17635 | 12-Lead (4mm × 3mm) Plastic DFN | -55°C to 125°C |
| LT1763CS8#PBF | LT1763CS8#TRPBF | 1763 | 8-Lead Plastic SO | -40°C to 125°C |
| LT1763IS8#PBF | LT1763IS8#TRPBF | 1763 | 8-Lead Plastic SO | -40°C to 125°C |
| LT1763MPS8#PBF | LT1763MPS8#TRPBF | 1763MP | 8-Lead Plastic SO | -55°C to 125°C |
| LT1763CS8-1.5#PBF | LT1763CS8-1.5#TRPBF | 176315 | 8-Lead Plastic SO | -40°C to 125°C |
| LT1763IS8-1.5#PBF | LT1763IS8-1.5#TRPBF | 176315 | 8-Lead Plastic SO | -40°C to 125°C |
| LT1763CS8-1.8#PBF | LT1763CS8-1.8#TRPBF | 176318 | 8-Lead Plastic SO | -40°C to 125°C |
| LT1763IS8-1.8#PBF | LT1763IS8-1.8#TRPBF | 176318 | 8-Lead Plastic SO | -40°C to 125°C |
| LT1763CS8-2.5#PBF | LT1763CS8-2.5#TRPBF | 176325 | 8-Lead Plastic SO | -40°C to 125°C |
| LT1763IS8-2.5#PBF | LT1763IS8-2.5#TRPBF | 176325 | 8-Lead Plastic SO | -40°C to 125°C |
| LT1763CS8-3#PBF | LT1763CS8-3#TRPBF | 17633 | 8-Lead Plastic SO | -40°C to 125°C |
| LT1763IS8-3#PBF | LT1763IS8-3#TRPBF | 17633 | 8-Lead Plastic SO | -40°C to 125°C |
| LT1763CS8-3.3#PBF | LT1763CS8-3.3#TRPBF | 176333 | 8-Lead Plastic SO | -40°C to 125°C |
| LT1763IS8-3.3#PBF | LT1763IS8-3.3#TRPBF | 176333 | 8-Lead Plastic SO | -40°C to 125°C |
| LT1763CS8-5#PBF | LT1763CS8-5#TRPBF | 17635 | 8-Lead Plastic SO | -40°C to 125°C |
| LT1763IS8-5#PBF | LT1763IS8-5#TRPBF | 17635 | 8-Lead Plastic SO | -40°C to 125°C |
| LEAD BASED FINISH | TAPE AND REEL | PART MARKING* | PACKAGE DESCRIPTION | TEMPERATURE RANGE |
| LT1763CDE | LT1763CDE#TR | 1763 | 12-Lead (4mm × 3mm) Plastic DFN | -40°C to 125°C |
| LT1763IDE | LT1763IDE#TR | 1763 | 12-Lead (4mm × 3mm) Plastic DFN | -40°C to 125°C |
| LT1763MPDE | LT1763MPDE#TR | 1763 | 12-Lead (4mm × 3mm) Plastic DFN | -55°C to 125°C |
| LT1763CDE-1.5 | LT1763CDE-1.5#TR | 76315 | 12-Lead (4mm × 3mm) Plastic DFN | -40°C to 125°C |
| LT1763IDE-1.5 | LT1763IDE-1.5#TR | 76315 | 12-Lead (4mm × 3mm) Plastic DFN | -40°C to 125°C |
| LT1763MPDE-1.5 | LT1763MPDE-1.5#TR | 76315 | 12-Lead (4mm × 3mm) Plastic DFN | -55°C to 125°C |
| LT1763CDE-1.8 | LT1763CDE-1.8#TR | 76318 | 12-Lead (4mm × 3mm) Plastic DFN | -40°C to 125°C |
| LT1763IDE-1.8 | LT1763IDE-1.8#TR | 76318 | 12-Lead (4mm × 3mm) Plastic DFN | -40°C to 125°C |
| LT1763MPDE-1.8 | LT1763MPDE-1.8#TR | 76318 | 12-Lead (4mm × 3mm) Plastic DFN | -55°C to 125°C |
| LT1763CDE-2.5 | LT1763CDE-2.5#TR | 76325 | 12-Lead (4mm × 3mm) Plastic DFN | -40°C to 125°C |
| LT1763IDE-2.5 | LT1763IDE-2.5#TR | 76325 | 12-Lead (4mm × 3mm) Plastic DFN | -40°C to 125°C |
| LT1763MPDE-2.5 | LT1763MPDE-2.5#TR | 76325 | 12-Lead (4mm × 3mm) Plastic DFN | -55°C to 125°C |
| LT1763CDE-3 | LT1763CDE-3#TR | 17633 | 12-Lead (4mm × 3mm) Plastic DFN | -40°C to 125°C |
| LT1763IDE-3 | LT1763IDE-3#TR | 17633 | 12-Lead (4mm × 3mm) Plastic DFN | -40°C to 125°C |
| LT1763MPDE-3 | LT1763MPDE-3#TR | 17633 | 12-Lead (4mm × 3mm) Plastic DFN | -55°C to 125°C |

1763fg

LT1763 Series

ORDER INFORMATION

| LEAD FREE FINISH | TAPE AND REEL | PART MARKING* | PACKAGE DESCRIPTION | TEMPERATURE RANGE |
|------------------|-------------------|---------------|---------------------------------|-------------------|
| LT1763CDE-3.3 | LT1763CDE-3.3#TR | 76333 | 12-Lead (4mm × 3mm) Plastic DFN | -40°C to 125°C |
| LT1763IDE-3.3 | LT1763IDE-3.3#TR | 76333 | 12-Lead (4mm × 3mm) Plastic DFN | -40°C to 125°C |
| LT1763MPDE-3.3 | LT1763MPDE-3.3#TR | 76333 | 12-Lead (4mm × 3mm) Plastic DFN | -55°C to 125°C |
| LT1763CDE-5 | LT1763CDE-5#TR | 17635 | 12-Lead (4mm × 3mm) Plastic DFN | -40°C to 125°C |
| LT1763IDE-5 | LT1763IDE-5#TR | 17635 | 12-Lead (4mm × 3mm) Plastic DFN | -40°C to 125°C |
| LT1763MPDE-5 | LT1763MPDE-5#TR | 17635 | 12-Lead (4mm × 3mm) Plastic DFN | -55°C to 125°C |
| LT1763CS8 | LT1763CS8#TR | 1763 | 8-Lead Plastic SO | -40°C to 125°C |
| LT1763IS8 | LT1763IS8#TR | 1763 | 8-Lead Plastic SO | -40°C to 125°C |
| LT1763MPS8 | LT1763MPS8#TR | 1763MP | 8-Lead Plastic SO | -55°C to 125°C |
| LT1763CS8-1.5 | LT1763CS8-1.5#TR | 176315 | 8-Lead Plastic SO | -40°C to 125°C |
| LT1763IS8-1.5 | LT1763IS8-1.5#TR | 176315 | 8-Lead Plastic SO | -40°C to 125°C |
| LT1763CS8-1.8 | LT1763CS8-1.8#TR | 176318 | 8-Lead Plastic SO | -40°C to 125°C |
| LT1763IS8-1.8 | LT1763IS8-1.8#TR | 176318 | 8-Lead Plastic SO | -40°C to 125°C |
| LT1763CS8-2.5 | LT1763CS8-2.5#TR | 176325 | 8-Lead Plastic SO | -40°C to 125°C |
| LT1763IS8-2.5 | LT1763IS8-2.5#TR | 176325 | 8-Lead Plastic SO | -40°C to 125°C |
| LT1763CS8-3 | LT1763CS8-3#TR | 17633 | 8-Lead Plastic SO | -40°C to 125°C |
| LT1763IS8-3 | LT1763IS8-3#TR | 17633 | 8-Lead Plastic SO | -40°C to 125°C |
| LT1763CS8-3.3 | LT1763CS8-3.3#TR | 176333 | 8-Lead Plastic SO | -40°C to 125°C |
| LT1763IS8-3.3 | LT1763IS8-3.3#TR | 176333 | 8-Lead Plastic SO | -40°C to 125°C |
| LT1763CS8-5 | LT1763CS8-5#TR | 17635 | 8-Lead Plastic SO | -40°C to 125°C |
| LT1763IS8-5 | LT1763IS8-5#TR | 17635 | 8-Lead Plastic SO | -40°C to 125°C |

Consult LTC Marketing for parts specified with wider operating temperature ranges. *The temperature grade is identified by a label on the shipping container.

For more information on lead free part marking, go to: <http://www.linear.com/leadfree/>

For more information on tape and reel specifications, go to: <http://www.linear.com/tapeandree/>

ELECTRICAL CHARACTERISTICS

The ● denotes the specifications which apply over the full operating temperature range, otherwise specifications are at $T_A = 25^\circ\text{C}$. (Note 2)

| PARAMETER | CONDITIONS | | MIN | TYP | MAX | UNITS |
|--|--|-------|-------|-------|-------|-------|
| Minimum Operating Voltage | C, I Grade: $I_{LOAD} = 500\text{mA}$ (Notes 3, 11) | ● | | 1.8 | 2.3 | V |
| | MP Grade: $I_{LOAD} = 500\text{mA}$ (Notes 3, 11) | ● | | 1.8 | 2.35 | V |
| Regulated Output Voltage (Note 4) | LT1763-1.5 $V_{IN} = 2\text{V}$, $I_{LOAD} = 1\text{mA}$ $2.5\text{V} < V_{IN} < 20\text{V}$, $1\text{mA} < I_{LOAD} < 500\text{mA}$ | ● | 1.485 | 1.5 | 1.515 | V |
| | | ● | 1.462 | 1.5 | 1.538 | V |
| | LT1763-1.8 $V_{IN} = 2.3\text{V}$, $I_{LOAD} = 1\text{mA}$ $2.8\text{V} < V_{IN} < 20\text{V}$, $1\text{mA} < I_{LOAD} < 500\text{mA}$ | ● | 1.782 | 1.8 | 1.818 | V |
| | | ● | 1.755 | 1.8 | 1.845 | V |
| | LT1763-2.5 $V_{IN} = 3\text{V}$, $I_{LOAD} = 1\text{mA}$ $3.5\text{V} < V_{IN} < 20\text{V}$, $1\text{mA} < I_{LOAD} < 500\text{mA}$ | ● | 2.475 | 2.5 | 2.525 | V |
| | | ● | 2.435 | 2.5 | 2.565 | V |
| LT1763-3 $V_{IN} = 3.5\text{V}$, $I_{LOAD} = 1\text{mA}$ $4\text{V} < V_{IN} < 20\text{V}$, $1\text{mA} < I_{LOAD} < 500\text{mA}$ | ● | 2.970 | 3 | 3.030 | V | |
| | ● | 2.925 | 3 | 3.075 | V | |
| LT1763-3.3 $V_{IN} = 3.8\text{V}$, $I_{LOAD} = 1\text{mA}$ $4.3\text{V} < V_{IN} < 20\text{V}$, $1\text{mA} < I_{LOAD} < 500\text{mA}$ | ● | 3.267 | 3.3 | 3.333 | V | |
| | ● | 3.220 | 3.3 | 3.380 | V | |
| LT1763-5 $V_{IN} = 5.5\text{V}$, $I_{LOAD} = 1\text{mA}$ $6\text{V} < V_{IN} < 20\text{V}$, $1\text{mA} < I_{LOAD} < 500\text{mA}$ | ● | 4.950 | 5 | 5.050 | V | |
| | ● | 4.875 | 5 | 5.125 | V | |

1763fg

ELECTRICAL CHARACTERISTICS

The ● denotes the specifications which apply over the full operating temperature range, otherwise specifications are at $T_A = 25^\circ\text{C}$. (Note 2)

| PARAMETER | CONDITIONS | MIN | TYP | MAX | UNITS | |
|---|---|-------------------------|-------|-------|----------------------------|---------------|
| ADJ Pin Voltage (Notes 3, 4) | LT1763 $V_{IN} = 2.2\text{V}$, $I_{LOAD} = 1\text{mA}$ | ● 1.208 | 1.220 | 1.232 | V | |
| | C, I Grade: $2.3\text{V} < V_{IN} < 20\text{V}$, $1\text{mA} < I_{LOAD} < 500\text{mA}$ | ● 1.190 | 1.220 | 1.250 | V | |
| | MP Grade: $2.35\text{V} < V_{IN} < 20\text{V}$, $1\text{mA} < I_{LOAD} < 500\text{mA}$ | ● 1.190 | 1.220 | 1.250 | V | |
| Line Regulation | LT1763-1.5 C, I Grade: $\Delta V_{IN} = 2\text{V}$ to 20V , $I_{LOAD} = 1\text{mA}$ | ● | 1 | 5 | mV | |
| | LT1763-1.5 MP Grade: $\Delta V_{IN} = 2.1\text{V}$ to 20V , $I_{LOAD} = 1\text{mA}$ | ● | 1 | 5 | mV | |
| | LT1763-1.8 $\Delta V_{IN} = 2.3\text{V}$ to 20V , $I_{LOAD} = 1\text{mA}$ | ● | 1 | 5 | mV | |
| | LT1763-2.5 $\Delta V_{IN} = 3\text{V}$ to 20V , $I_{LOAD} = 1\text{mA}$ | ● | 1 | 5 | mV | |
| | LT1763-3 $\Delta V_{IN} = 3.5\text{V}$ to 20V , $I_{LOAD} = 1\text{mA}$ | ● | 1 | 5 | mV | |
| | LT1763-3.3 $\Delta V_{IN} = 3.8\text{V}$ to 20V , $I_{LOAD} = 1\text{mA}$ | ● | 1 | 5 | mV | |
| | LT1763-5 $\Delta V_{IN} = 5.5\text{V}$ to 20V , $I_{LOAD} = 1\text{mA}$ | ● | 1 | 5 | mV | |
| | LT1763 (Note 3) C, I Grade: $\Delta V_{IN} = 2\text{V}$ to 20V , $I_{LOAD} = 1\text{mA}$ | ● | 1 | 5 | mV | |
| | LT1763 (Note 3) MP Grade: $\Delta V_{IN} = 2.1\text{V}$ to 20V , $I_{LOAD} = 1\text{mA}$ | ● | 1 | 5 | mV | |
| Load Regulation | LT1763-1.5 $V_{IN} = 2.5\text{V}$, $\Delta I_{LOAD} = 1\text{mA}$ to 500mA | ● | 3 | 8 | mV | |
| | $V_{IN} = 2.5\text{V}$, $\Delta I_{LOAD} = 1\text{mA}$ to 500mA | ● | | 15 | mV | |
| | LT1763-1.8 $V_{IN} = 2.8\text{V}$, $\Delta I_{LOAD} = 1\text{mA}$ to 500mA | ● | 4 | 9 | mV | |
| | $V_{IN} = 2.8\text{V}$, $\Delta I_{LOAD} = 1\text{mA}$ to 500mA | ● | | 18 | mV | |
| | LT1763-2.5 $V_{IN} = 3.5\text{V}$, $\Delta I_{LOAD} = 1\text{mA}$ to 500mA | ● | 5 | 12 | mV | |
| | $V_{IN} = 3.5\text{V}$, $\Delta I_{LOAD} = 1\text{mA}$ to 500mA | ● | | 25 | mV | |
| | LT1763-3 $V_{IN} = 4\text{V}$, $\Delta I_{LOAD} = 1\text{mA}$ to 500mA | ● | 7 | 15 | mV | |
| | $V_{IN} = 4\text{V}$, $\Delta I_{LOAD} = 1\text{mA}$ to 500mA | ● | | 30 | mV | |
| Dropout Voltage $V_{IN} = V_{OUT(\text{NOMINAL})}$ (Notes 5, 6, 11) | $I_{LOAD} = 10\text{mA}$ | ● | 0.13 | 0.19 | V | |
| | $I_{LOAD} = 10\text{mA}$ | ● | | 0.25 | V | |
| Dropout Voltage $V_{IN} = V_{OUT(\text{NOMINAL})}$ (Notes 5, 6, 11) | $I_{LOAD} = 50\text{mA}$ | ● | 0.17 | 0.22 | V | |
| | $I_{LOAD} = 50\text{mA}$ | ● | | 0.32 | V | |
| | $I_{LOAD} = 100\text{mA}$ | ● | 0.20 | 0.24 | V | |
| | $I_{LOAD} = 100\text{mA}$ | ● | | 0.34 | V | |
| Dropout Voltage $V_{IN} = V_{OUT(\text{NOMINAL})}$ (Notes 5, 6, 11) | $I_{LOAD} = 500\text{mA}$ | ● | 0.30 | 0.35 | V | |
| | $I_{LOAD} = 500\text{mA}$ | ● | | 0.45 | V | |
| | GND Pin Current $V_{IN} = V_{OUT(\text{NOMINAL})}$ (Notes 5, 7) | $I_{LOAD} = 0\text{mA}$ | ● | 30 | 75 | μA |
| | | $I_{LOAD} = 1\text{mA}$ | ● | 65 | 120 | μA |
| $I_{LOAD} = 50\text{mA}$ | | ● | 1.1 | 1.6 | mA | |
| $I_{LOAD} = 100\text{mA}$ | | ● | 2 | 3 | mA | |
| $I_{LOAD} = 250\text{mA}$ | | ● | 5 | 8 | mA | |
| $I_{LOAD} = 500\text{mA}$ | | ● | 11 | 16 | mA | |
| Output Voltage Noise | $C_{OUT} = 10\mu\text{F}$, $C_{BYP} = 0.01\mu\text{F}$, $I_{LOAD} = 500\text{mA}$, BW = 10Hz to 100kHz | | 20 | | μV_{RMS} | |
| ADJ Pin Bias Current | (Notes 3, 8) | | 30 | 100 | nA | |
| Shutdown Threshold | $V_{OUT} = \text{Off to On}$ | ● | 0.8 | 2 | V | |
| | $V_{OUT} = \text{On to Off}$ | ● | 0.25 | 0.65 | V | |
| SHDN Pin Current (Note 9) | $V_{SHDN} = 0\text{V}$ | | 0.1 | | μA | |
| | $V_{SHDN} = 20\text{V}$ | | 1 | | μA | |
| Quiescent Current in Shutdown | $V_{IN} = 6\text{V}$, $V_{SHDN} = 0\text{V}$ | | 0.1 | 1 | μA | |
| Ripple Rejection | $V_{IN} - V_{OUT} = 1.5\text{V}$ (Avg), $V_{\text{RIPPLE}} = 0.5\text{V}_{\text{P-P}}$, $f_{\text{RIPPLE}} = 120\text{Hz}$, $I_{LOAD} = 500\text{mA}$ | | 50 | 65 | dB | |

LT1763 Series

ELECTRICAL CHARACTERISTICS

The ● denotes the specifications which apply over the full operating temperature range, otherwise specifications are at $T_A = 25^\circ\text{C}$. (Note 2)

| PARAMETER | CONDITIONS | | MIN | TYP | MAX | UNITS |
|-------------------------------------|--|-----------------------------------|------------|-----|-----|---------------|
| Current Limit | $V_{IN} = 7V, V_{OUT} = 0V$ | | | | | |
| | C, I Grade: $V_{IN} = V_{OUT(NOMINAL)} + 1V$ or $2.3V$ (Note 12), $\Delta V_{OUT} = -0.1V$ MP Grade: $V_{IN} = 2.35V$ (Note 12), $\Delta V_{OUT} = -0.1V$ | ● ● | 520 520 | | | mA mA |
| Input Reverse Leakage Current | $V_{IN} = -20V, V_{OUT} = 0V$ | ● | | | 1 | mA |
| Reverse Output Current (Note 10) | LT1763-1.5 | $V_{OUT} = 1.5V, V_{IN} < 1.5V$ | | 10 | 20 | μA |
| | LT1763-1.8 | $V_{OUT} = 1.8V, V_{IN} < 1.8V$ | | 10 | 20 | μA |
| | LT1763-2.5 | $V_{OUT} = 2.5V, V_{IN} < 2.5V$ | | 10 | 20 | μA |
| | LT1763-3 | $V_{OUT} = 3V, V_{IN} < 3V$ | | 10 | 20 | μA |
| | LT1763-3.3 | $V_{OUT} = 3.3V, V_{IN} < 3.3V$ | | 10 | 20 | μA |
| | LT1763-5 | $V_{OUT} = 5V, V_{IN} < 5V$ | | 10 | 20 | μA |
| | LT1763 (Note 3) | $V_{OUT} = 1.22V, V_{IN} < 1.22V$ | | 5 | 10 | μA |

Note 1: Stresses beyond those listed under Absolute Maximum Ratings may cause permanent damage to the device. Exposure to any Absolute Maximum Rating condition for extended periods may affect device reliability and lifetime.

Note 2: The LT1763 regulators are tested and specified under pulse load conditions such that $T_J \cong T_A$. The LT1763 (C grade) is 100% tested at $T_A = 25^\circ\text{C}$; performance at -40°C and 125°C is assured by design, characterization and correlation with statistical process controls. The LT1763 (I grade) is guaranteed over the full -40°C to 125°C operating junction temperature range. The LT1763 (MP grade) is 100% tested and guaranteed over the -55°C to 125°C operating junction temperature range.

Note 3: The LT1763 (adjustable version) is tested and specified for these conditions with the ADJ pin connected to the OUT pin.

Note 4: Operating conditions are limited by maximum junction temperature. The regulated output voltage specification will not apply for all possible combinations of input voltage and output current. When operating at maximum input voltage, the output current range must be limited. When operating at maximum output current, the input voltage range must be limited.

Note 5: To satisfy requirements for minimum input voltage, the LT1763 (adjustable version) is tested and specified for these conditions with an external resistor divider (two 250k resistors) for an output voltage of 2.44V. The external resistor divider will add a 5 μA DC load on the output.

Note 6: Dropout voltage is the minimum input to output voltage differential needed to maintain regulation at a specified output current. In dropout, the output voltage will be equal to: $V_{IN} - V_{DROPOUT}$.

Note 7: GND pin current is tested with $V_{IN} = V_{OUT(NOMINAL)}$ or $V_{IN} = 2.3V$ (C, I grade) or $2.35V$ (MP grade), whichever is greater, and a current source load. This means the device is tested while operating in its dropout region. This is the worst-case GND pin current. The GND pin current will decrease slightly at higher input voltages.

Note 8: ADJ pin bias current flows into the ADJ pin.

Note 9: $\overline{\text{SHDN}}$ pin current flows into the $\overline{\text{SHDN}}$ pin.

Note 10: Reverse output current is tested with the IN pin grounded and the OUT pin forced to the rated output voltage. This current flows into the OUT pin and out the GND pin.

Note 11: For the LT1763, LT1763-1.5 and LT1763-1.8 dropout voltage will be limited by the minimum input voltage specification under some output voltage/load conditions. See the curve of Minimum Input Voltage in the Typical Performance Characteristics.

Note 12: To satisfy requirements for minimum input voltage, current limit is tested at $V_{IN} = V_{OUT(NOMINAL)} + 1V$ or $2.3V$ (C, I grade) or $2.35V$ (MP grade), whichever is greater.

TYPICAL PERFORMANCE CHARACTERISTICS

Typical Dropout Voltage

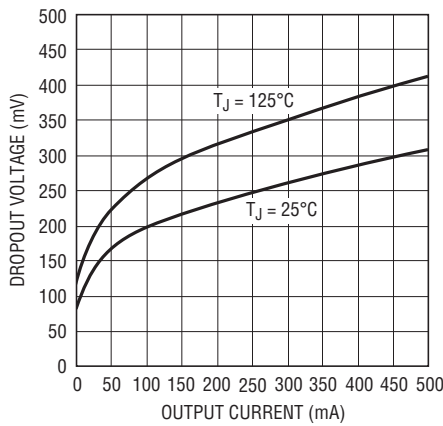

1763 G01

Guaranteed Dropout Voltage

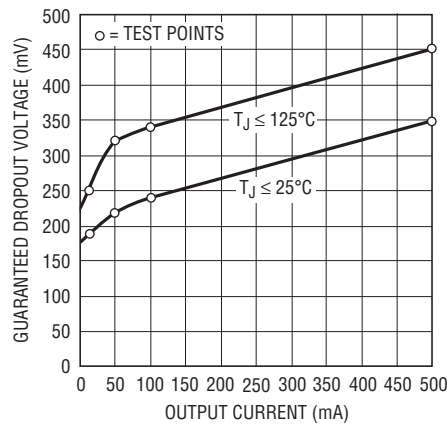

1763 G02

Dropout Voltage

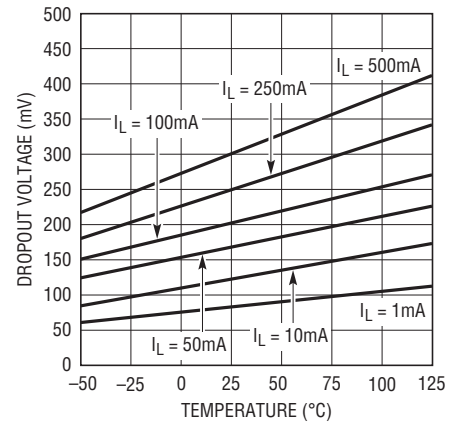

1763 G03

Quiescent Current

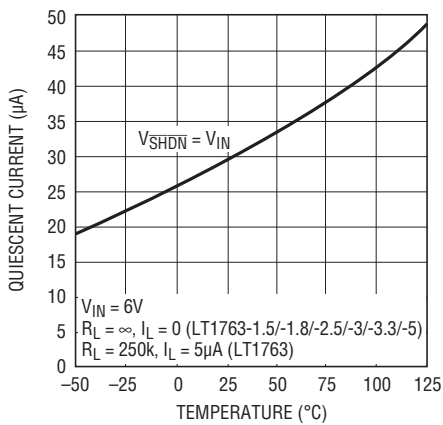

1763 G04

LT1763-1.5 Output Voltage

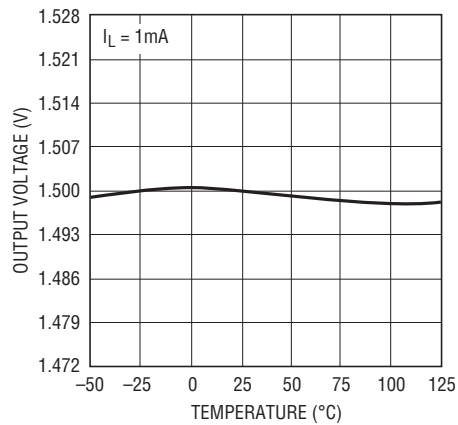

1763 G05

LT1763-1.8 Output Voltage

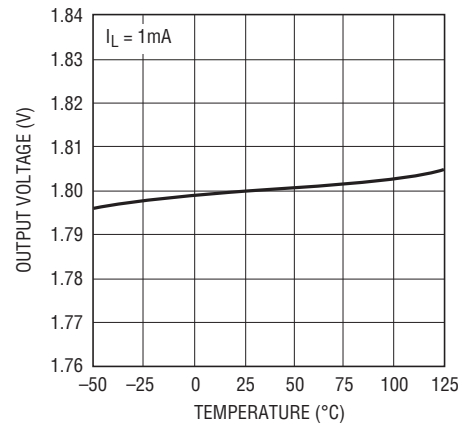

1763 G06

LT1763-2.5 Output Voltage

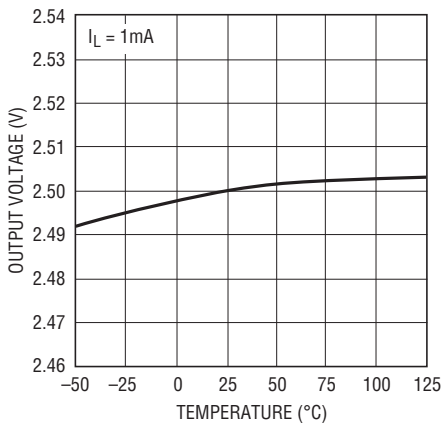

1763 G07

LT1763-3 Output Voltage

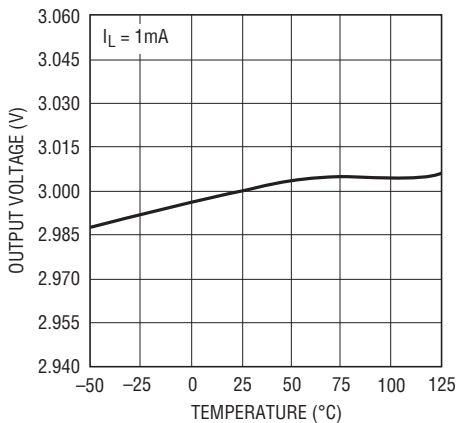

1763 G08

LT1763-3.3 Output Voltage

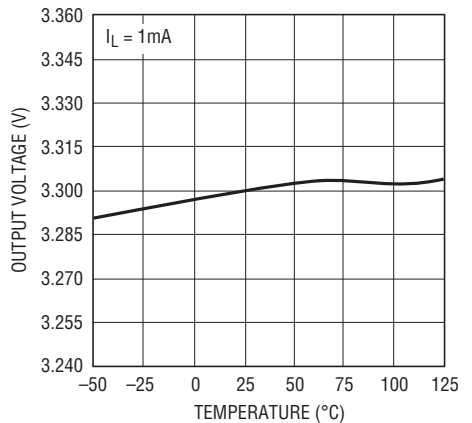

1763 G09

TYPICAL PERFORMANCE CHARACTERISTICS

**LT1763-5
Output Voltage**

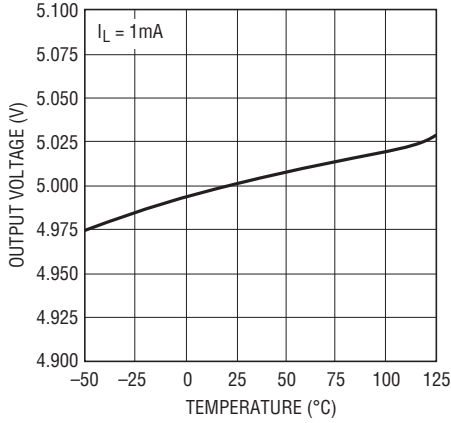

1763 G10

**LT1763
ADJ Pin Voltage**

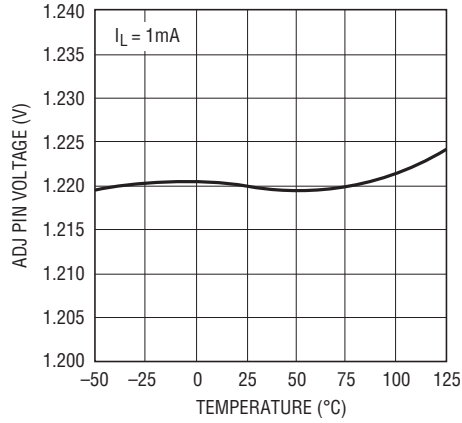

1763 G11

**LT1763-1.5
Quiescent Current**

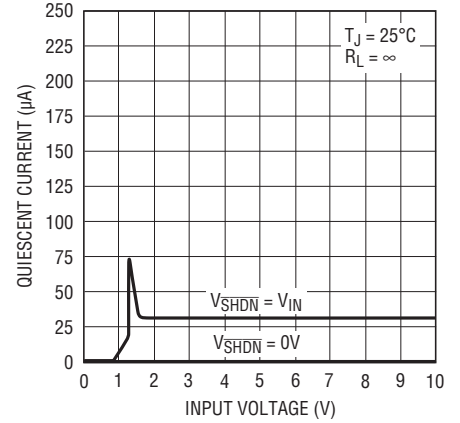

1763 G12

**LT1763-1.8
Quiescent Current**

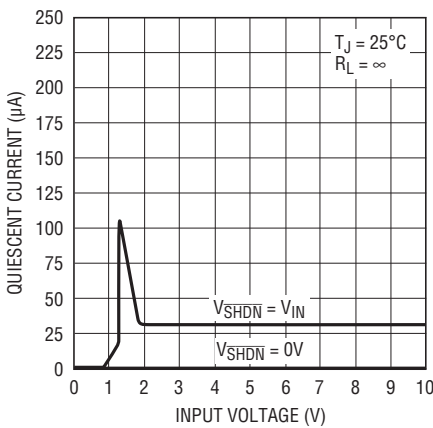

1763 G13

**LT1763-2.5
Quiescent Current**

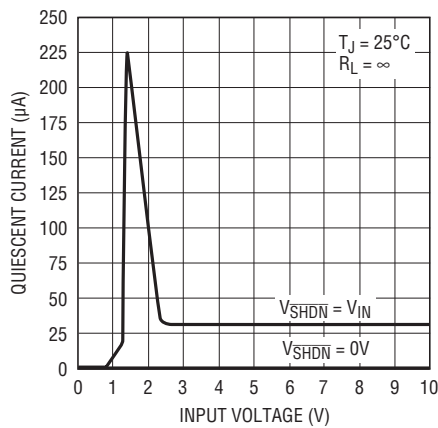

1763 G14

**LT1763-3
Quiescent Current**

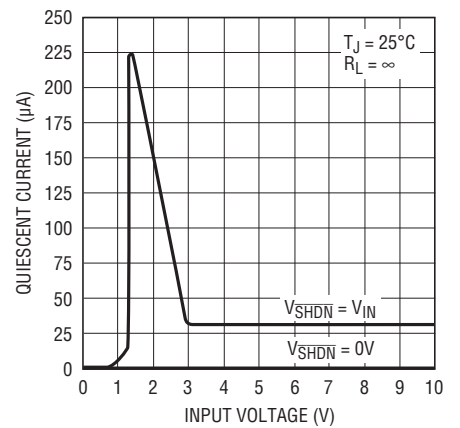

1763 G15

**LT1763-3.3
Quiescent Current**

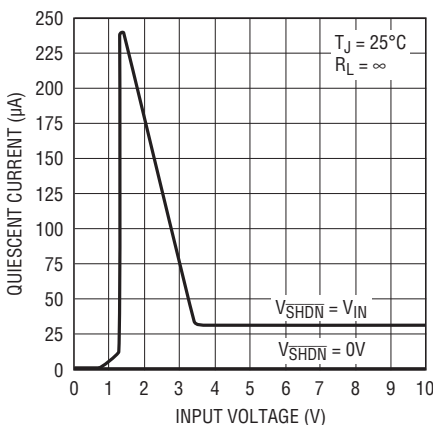

1763 G16

**LT1763-5
Quiescent Current**

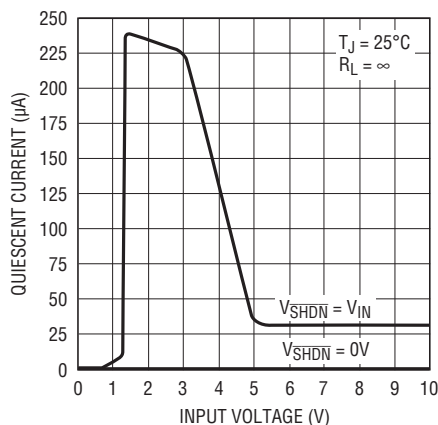

1763 G17

**LT1763
Quiescent Current**

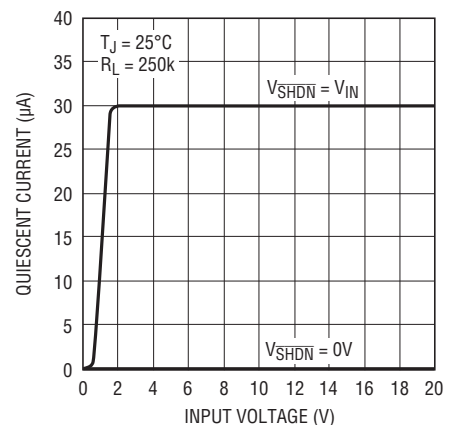

1763 G18

TYPICAL PERFORMANCE CHARACTERISTICS

LT1763-1.5
GND Pin Current

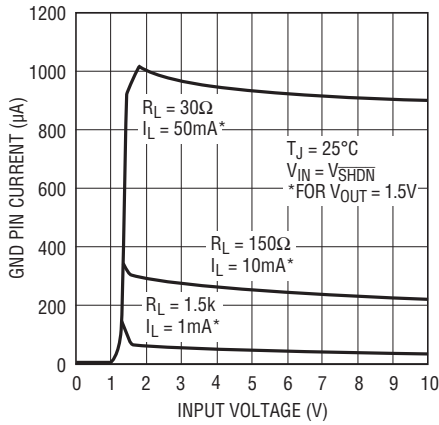

1763 G19

LT1763-1.8
GND Pin Current

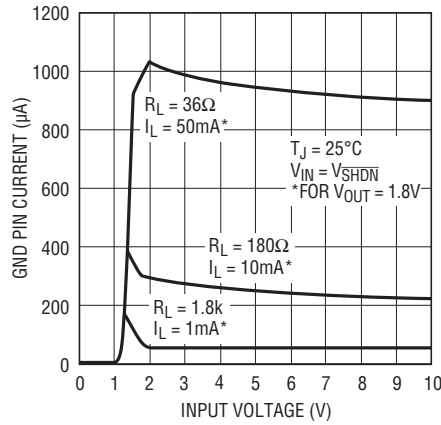

1763 G20

LT1763-2.5
GND Pin Current

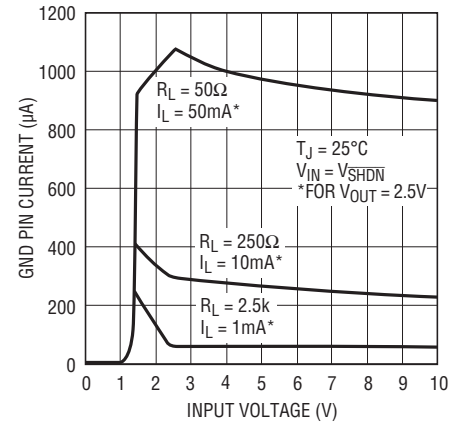

1763 G21

LT1763-3
GND Pin Current

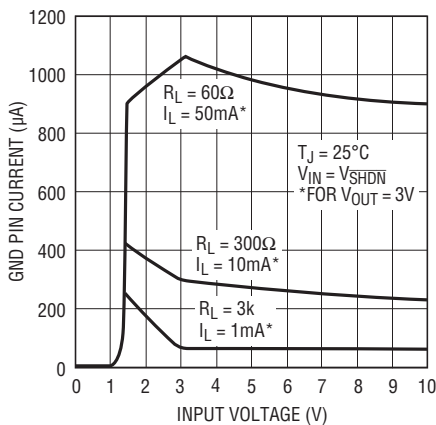

1763 G22

LT1763-3.3
GND Pin Current

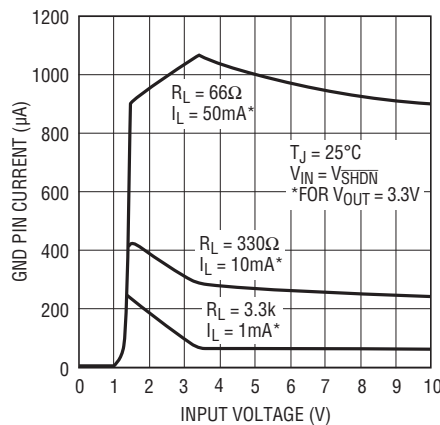

1763 G23

LT1763-5
GND Pin Current

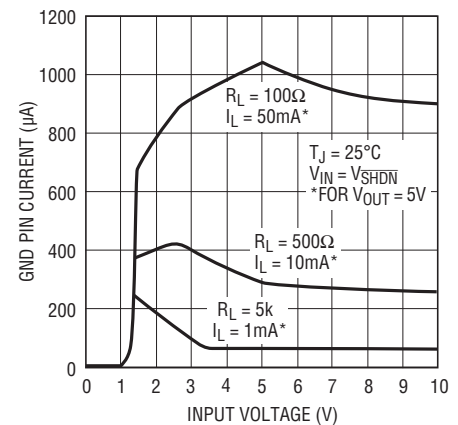

1763 G24

LT1763
GND Pin Current

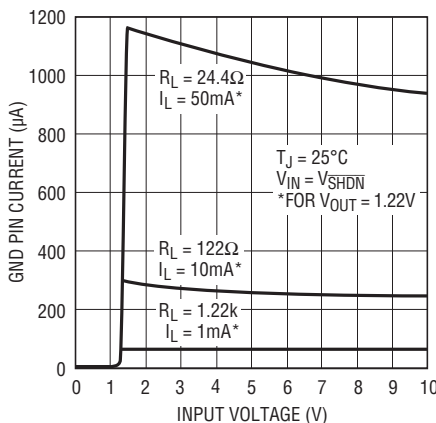

1763 G25

LT1763-1.5
GND Pin Current

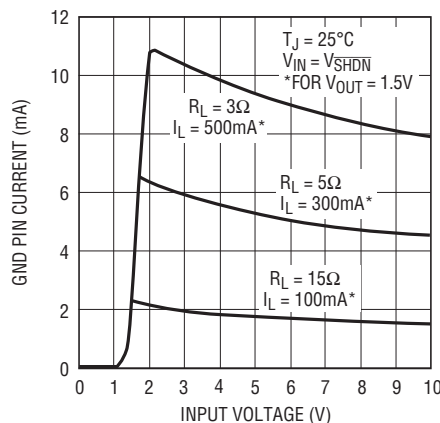

1763 G26

LT1763-1.8
GND Pin Current

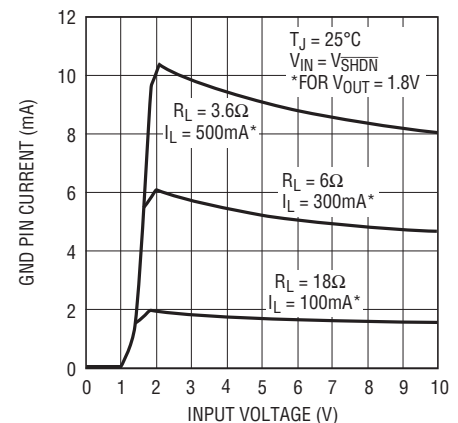

1763 G27

TYPICAL PERFORMANCE CHARACTERISTICS

**LT1763-2.5
GND Pin Current**

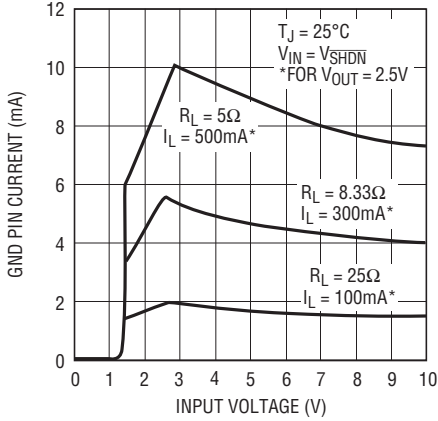

1763 G28

**LT1763-3
GND Pin Current**

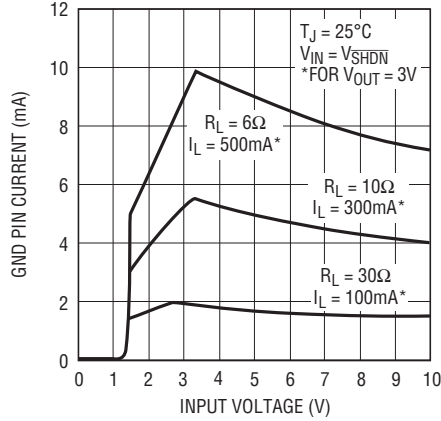

1763 G29

**LT1763-3.3
GND Pin Current**

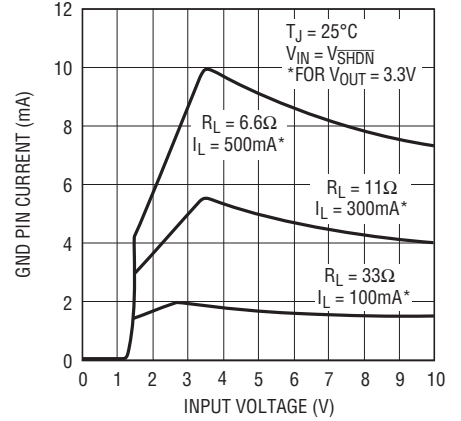

1763 G30

**LT1763-5
GND Pin Current**

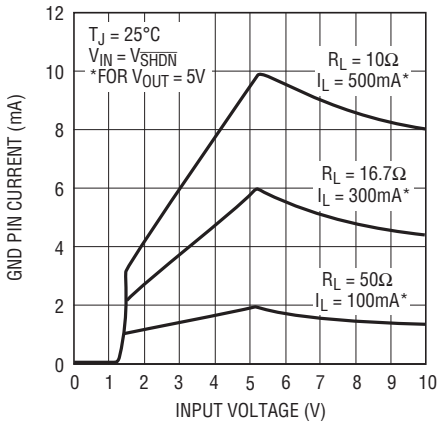

1763 G31

**LT1763
GND Pin Current**

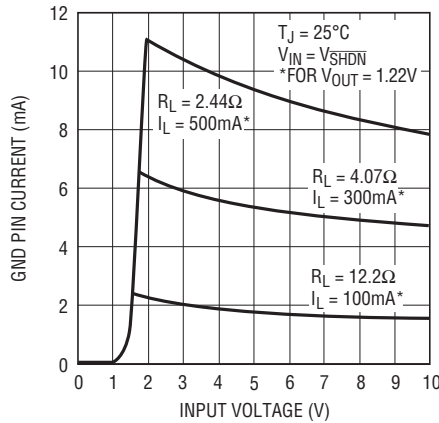

1763 G32

GND Pin Current vs ILOAD

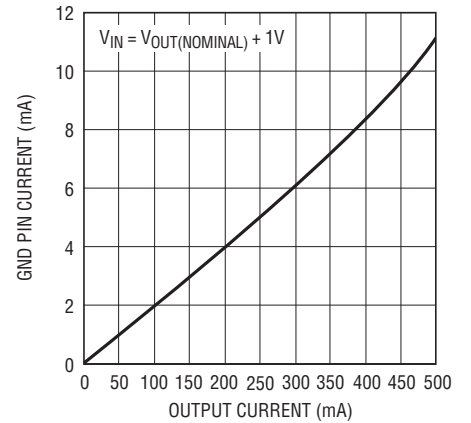

1763 G33

**SHDN Pin Threshold
(On-to-Off)**

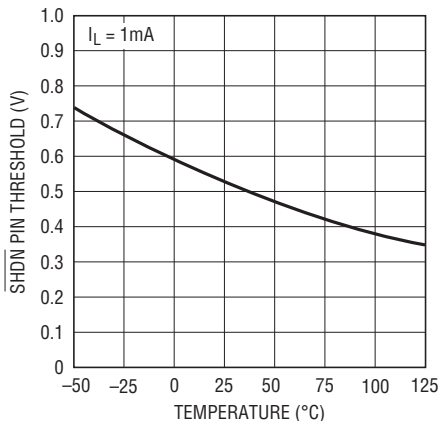

1763 G34

**SHDN Pin Threshold
(Off-to-On)**

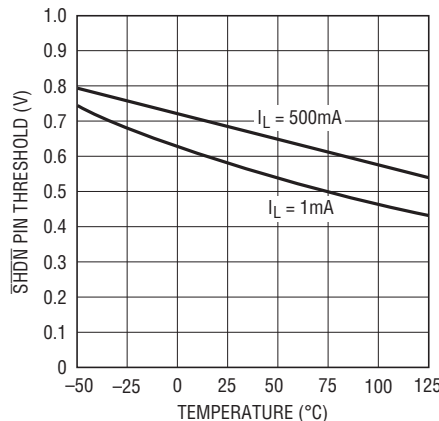

1763 G35

SHDN Pin Input Current

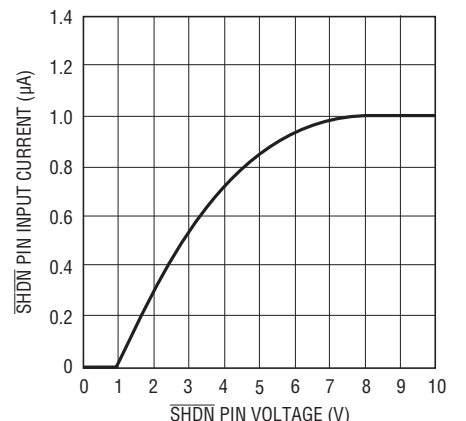

1763 G36

TYPICAL PERFORMANCE CHARACTERISTICS

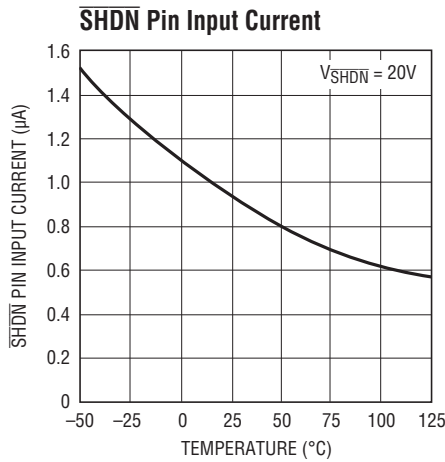

1763 G37

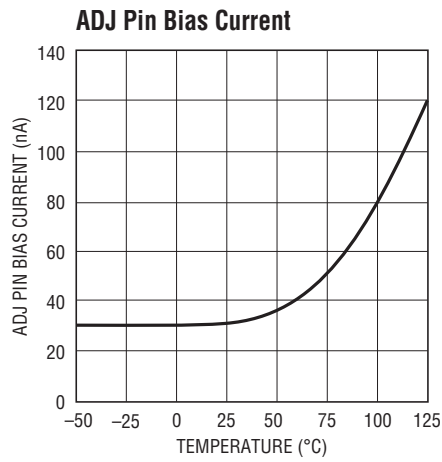

1763 G38

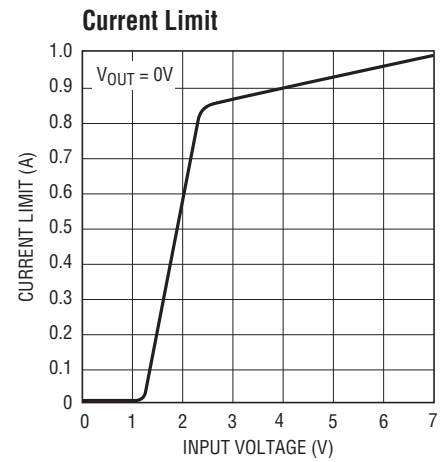

1763 G39

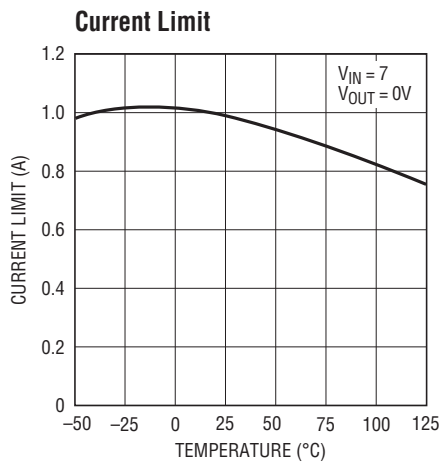

1763 G40

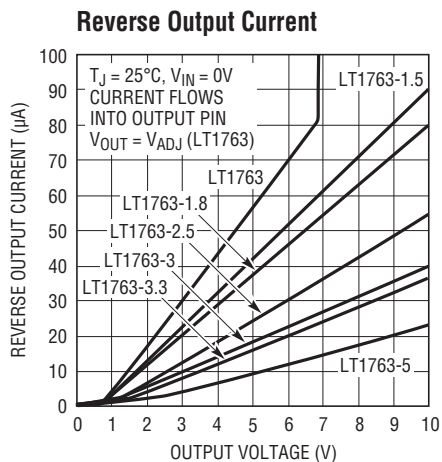

1763 G41

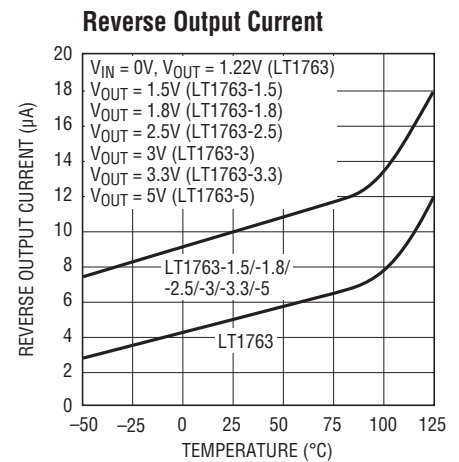

1763 G42

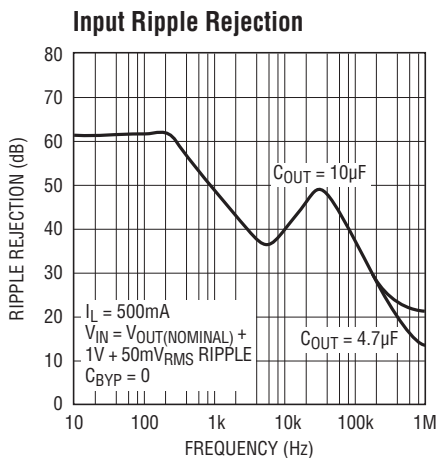

1763 G43

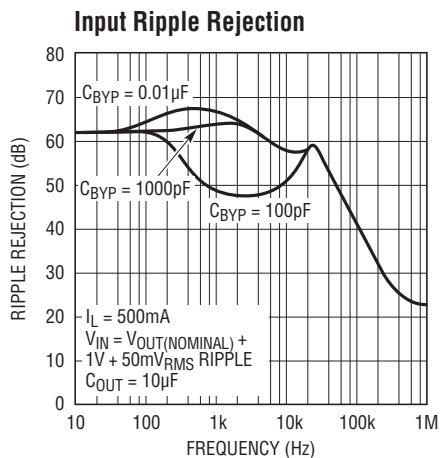

1763 G44

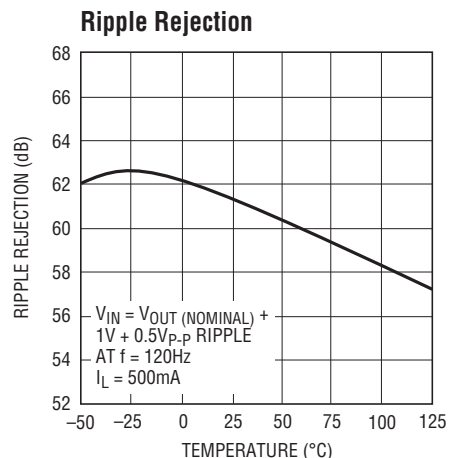

1763 G45

LT1763 Series

TYPICAL PERFORMANCE CHARACTERISTICS

LT1763
Minimum Input Voltage

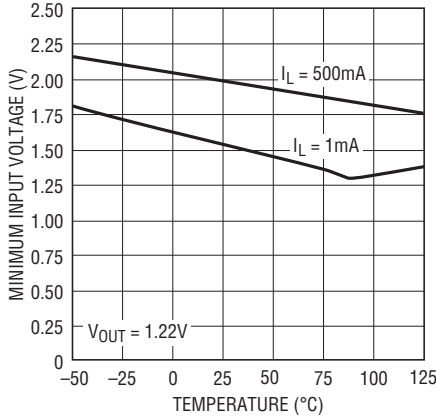

1763 G46

Load Regulation

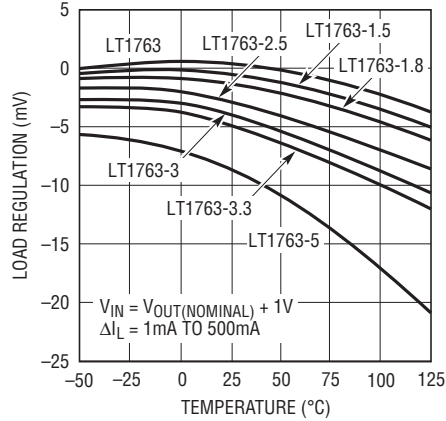

1763 G47

Output Noise Spectral Density
C_{BYP} = 0

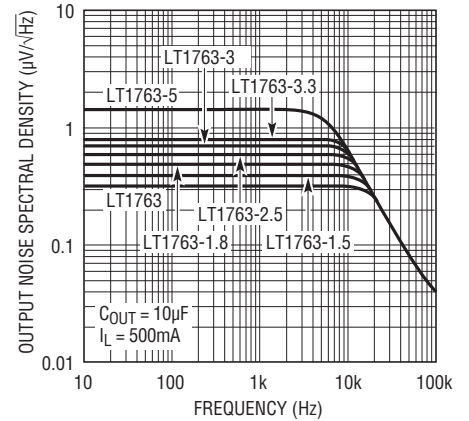

1763 G48

Output Noise Spectral Density

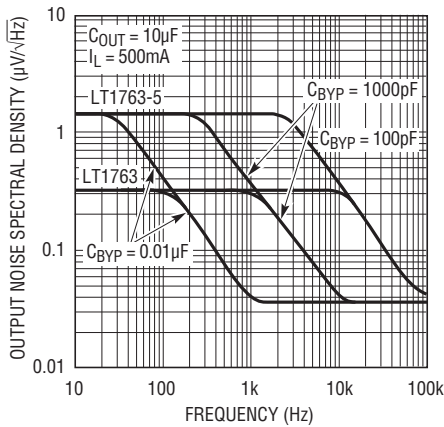

1763 G49

RMS Output Noise vs Bypass Capacitor

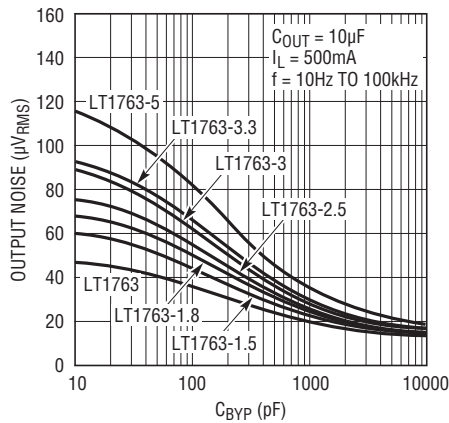

1763 G50

RMS Output Noise vs Load Current (10Hz to 100kHz)

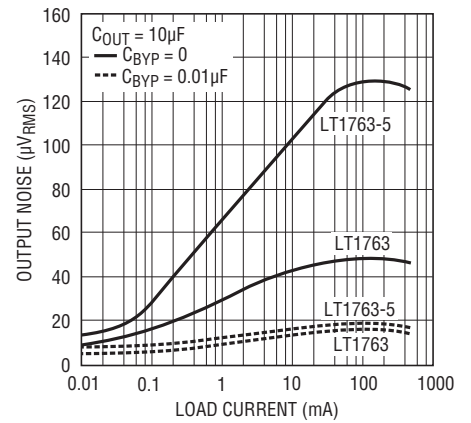

1763 G51

LT1763-5
10Hz to 100kHz Output Noise
C_{BYP} = 0

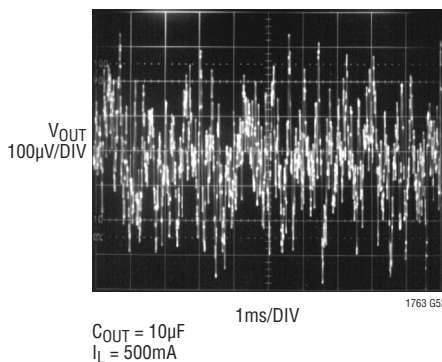

1763 G52

LT1763-5
10Hz to 100kHz Output Noise
C_{BYP} = 100pF

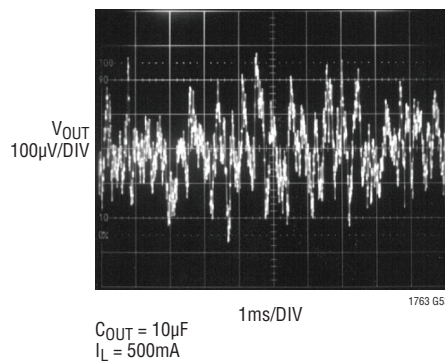

1763 G53

LT1763-5
10Hz to 100kHz Output Noise
C_{BYP} = 1000pF

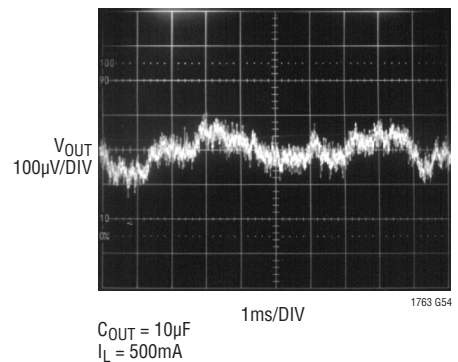

1763 G54

1763fg

TYPICAL PERFORMANCE CHARACTERISTICS

LT1763-5
10Hz to 100kHz Output Noise
 $C_{BYP} = 0.01\mu F$

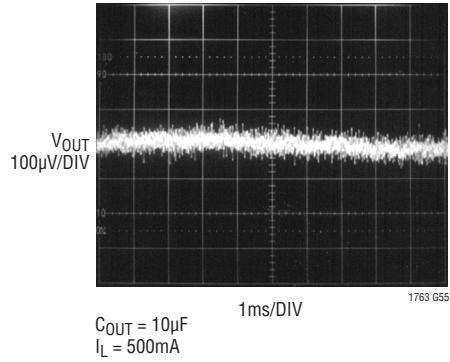

LT1763-5
Transient Response
 $C_{BYP} = 0$

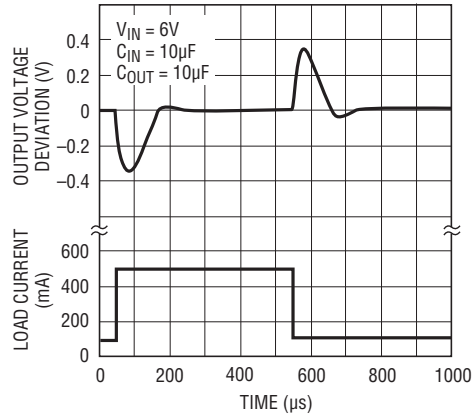

LT1763-5
Transient Response
 $C_{BYP} = 0.01\mu F$

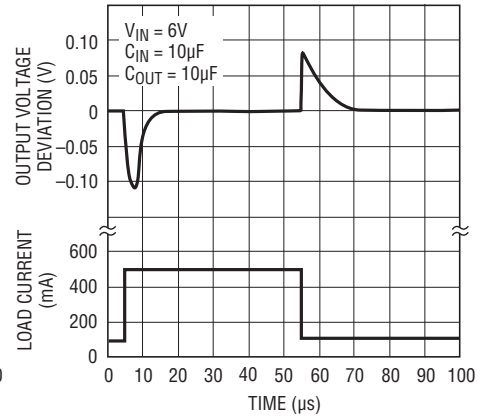

PIN FUNCTIONS (DE12/S8)

NC (Pins 1, 4, 9, 12) DE12 Only: No Connect. No connect pins have no connection to any internal circuitry. These pins may be tied to either GND or V_{IN} , or left floating.

OUT (Pins 2, 3/Pin 1): Output. The output supplies power to the load. A minimum output capacitor of $3.3\mu\text{F}$ is required to prevent oscillations. Larger output capacitors will be required for applications with large transient loads to limit peak voltage transients. See the Applications Information section for more information on output capacitance and reverse output characteristics.

ADJ (Pin 5/Pin 2): Adjust. For the adjustable LT1763, this is the input to the error amplifier. This pin is internally clamped to $\pm 7\text{V}$. It has a bias current of 30nA which flows into the pin (see the curve of ADJ Pin Bias Current vs Temperature in the Typical Performance Characteristics section). The ADJ pin voltage is 1.22V referenced to ground and the output voltage range is 1.22V to 20V .

SENSE (Pin 5/Pin 2): Output Sense. For fixed voltage versions of the LT1763 (LT1763-1.5/LT1763-1.8/LT1763-2.5/LT1763-3/LT1763-3.3/LT1763-5), the SENSE pin is the input to the error amplifier. Optimum regulation will be obtained at the point where the SENSE pin is connected to the OUT pin of the regulator. In critical applications, small voltage drops are caused by the resistance (R_P) of PC traces between the regulator and the load. These may be eliminated by connecting the SENSE pin to the output at the load as shown in Figure 1 (Kelvin Sense Connection).

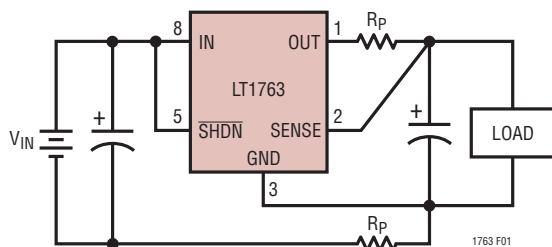

Figure 1. Kelvin Sense Connection

Note that the voltage drop across the external PC traces will add to the dropout voltage of the regulator. The SENSE pin bias current is $10\mu\text{A}$ at the nominal rated output voltage. The SENSE pin can be pulled below ground (as in a dual supply system where the regulator load is returned to a negative supply) and still allow the device to start and operate.

BYP (Pin 6/Pin 4): Bypass. The BYP pin is used to bypass the reference of the LT1763 regulators to achieve low noise performance from the regulator. The BYP pin is clamped internally to $\pm 0.6\text{V}$ (one V_{BE}). A small capacitor from the output to this pin will bypass the reference to lower the output voltage noise. A maximum value of $0.01\mu\text{F}$ can be used for reducing output voltage noise to a typical $20\mu\text{V}_{\text{RMS}}$ over a 10Hz to 100kHz bandwidth. If not used, this pin must be left unconnected.

GND (Pins 7, Exposed Pad Pin 13/Pins 3, 6, 7): Ground. The exposed pad of the DFN package is an electrical connection to GND. To ensure proper electrical and thermal performance, solder Pin 13 to the PCB ground and tie directly to Pin 7. Connect the bottom of the output voltage setting resistor divider directly to the GND pins for optimum load regulation performance.

SHDN (Pin 8/Pin 5): Shutdown. The $\overline{\text{SHDN}}$ pin is used to put the LT1763 regulators into a low power shutdown state. The output will be off when the $\overline{\text{SHDN}}$ pin is pulled low. The $\overline{\text{SHDN}}$ pin can be driven either by 5V logic or open-collector logic with a pull-up resistor. The pull-up resistor is required to supply the pull-up current of the open-collector gate, normally several microamperes, and the $\overline{\text{SHDN}}$ pin current, typically $1\mu\text{A}$. If unused, the $\overline{\text{SHDN}}$ pin must be connected to V_{IN} . The device will be in the low power shutdown state if the $\overline{\text{SHDN}}$ pin is not connected.

IN (Pin 10, 11/Pin 8): Input. Power is supplied to the device through the IN pin. A bypass capacitor is required on this pin if the device is more than six inches away from the main input filter capacitor. In general, the output impedance of a battery rises with frequency, so it is advisable to include a bypass capacitor in battery-powered circuits. A bypass capacitor in the range of $1\mu\text{F}$ to $10\mu\text{F}$ is sufficient. The LT1763 regulators are designed to withstand reverse voltages on the IN pin with respect to ground and the OUT pin. In the case of a reverse input, which can happen if a battery is plugged in backwards, the device will act as if there is a diode in series with its input. There will be no reverse current flow into the regulator and no reverse voltage will appear at the load. The device will protect both itself and the load.

APPLICATIONS INFORMATION

The LT1763 series are 500mA low dropout regulators with micropower quiescent current and shutdown. The devices are capable of supplying 500mA at a dropout voltage of 300mV. Output voltage noise can be lowered to $20\mu\text{V}_{\text{RMS}}$ over a 10Hz to 100kHz bandwidth with the addition of a $0.01\mu\text{F}$ reference bypass capacitor. Additionally, the reference bypass capacitor will improve transient response of the regulator, lowering the settling time for transient load conditions. The low operating quiescent current ($30\mu\text{A}$) drops to less than $1\mu\text{A}$ in shutdown. In addition to the low quiescent current, the LT1763 regulators incorporate several protection features which make them ideal for use in battery-powered systems. The devices are protected against both reverse input and reverse output voltages. In battery backup applications where the output can be held up by a backup battery when the input is pulled to ground, the LT1763-X acts like it has a diode in series with its output and prevents reverse current flow. Additionally, in dual supply applications where the regulator load is returned to a negative supply, the output can be pulled below ground by as much as 20V and still allow the device to start and operate.

Adjustable Operation

The adjustable version of the LT1763 has an output voltage range of 1.22V to 20V. The output voltage is set by the ratio of two external resistors, as shown in Figure 2. The device servos the output to maintain the ADJ pin voltage at 1.22V referenced to ground. The current in R1 is then equal to $1.22\text{V}/R1$ and the current in R2 is the current in R1 plus the ADJ pin bias current. The ADJ pin bias current, 30nA at 25°C , flows through R2 into the ADJ pin. The output voltage can be calculated using the formula in Figure 2. The value of R1 should be no greater than $250\text{k}\Omega$ to minimize errors in the output voltage caused by the ADJ pin bias current. Note that in shutdown the output is turned off and the divider current will be zero. Curves of ADJ Pin Voltage vs Temperature and ADJ Pin Bias Current vs Temperature appear in the Typical Performance Characteristics section.

The adjustable device is tested and specified with the ADJ pin tied to the OUT pin for an output voltage of 1.22V. Specifications for output voltages greater than 1.22V will be proportional to the ratio of the desired output voltage

to 1.22V : $V_{\text{OUT}}/1.22\text{V}$. For example, load regulation for an output current change of 1mA to 500mA is -2mV typical at $V_{\text{OUT}} = 1.22\text{V}$. At $V_{\text{OUT}} = 12\text{V}$, load regulation is:

$$(12\text{V}/1.22\text{V})(-2\text{mV}) = -19.6\text{mV}$$

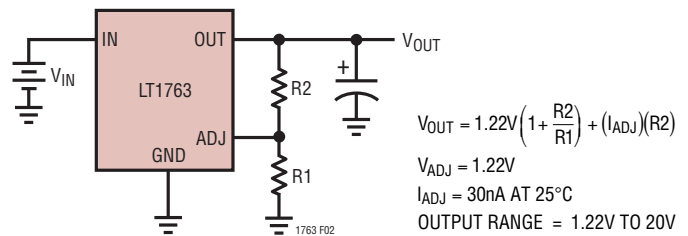

Figure 2. Adjustable Operation

Bypass Capacitance and Low Noise Performance

The LT1763 regulators may be used with the addition of a bypass capacitor from V_{OUT} to the BYP pin to lower output voltage noise. A good quality low leakage capacitor is recommended. This capacitor will bypass the reference of the regulator, providing a low frequency noise pole. The noise pole provided by this bypass capacitor will lower the output voltage noise to as low as $20\mu\text{V}_{\text{RMS}}$ with the addition of a $0.01\mu\text{F}$ bypass capacitor. Using a bypass capacitor has the added benefit of improving transient response. With no bypass capacitor and a $10\mu\text{F}$ output capacitor, a 10mA to 500mA load step will settle to within 1% of its final value in less than $100\mu\text{s}$. With the addition of a $0.01\mu\text{F}$ bypass capacitor, the output will settle to within 1% for a 10mA to 500mA load step in less than $10\mu\text{s}$, with total output voltage deviation of less than 2.5% (see the LT1763-5 Transient Response curve in the Typical Performance Characteristics section). However, regulator start-up time is proportional to the size of the bypass capacitor, slowing to 15ms with a $0.01\mu\text{F}$ bypass capacitor and $10\mu\text{F}$ output capacitor.

APPLICATIONS INFORMATION

Output Capacitance and Transient Response

The LT1763 regulators are designed to be stable with a wide range of output capacitors. The ESR of the output capacitor affects stability, most notably with small capacitors. A minimum output capacitor of $3.3\mu\text{F}$ with an ESR of 3Ω , or less, is recommended to prevent oscillations. The LT1763-X is a micropower device and output transient response will be a function of output capacitance. Larger values of output capacitance decrease the peak deviations and provide improved transient response for larger load current changes. Bypass capacitors, used to decouple individual components powered by the LT1763-X, will increase the effective output capacitor value. With larger capacitors used to bypass the reference (for low noise operation), larger values of output capacitors are needed. For 100pF of bypass capacitance, $4.7\mu\text{F}$ of output capacitor is recommended. With a 1000pF bypass capacitor or larger, a $6.8\mu\text{F}$ output capacitor is recommended.

The shaded region of Figure 3 defines the range over which the LT1763 regulators are stable. The minimum ESR needed is defined by the amount of bypass capacitance used, while the maximum ESR is 3Ω .

Extra consideration must be given to the use of ceramic capacitors. Ceramic capacitors are manufactured with a variety of dielectrics, each with different behavior across temperature and applied voltage. The most common dielectrics used are specified with EIA temperature characteristic codes of Z5U, Y5V, X5R and X7R. The Z5U and Y5V dielectrics are good for providing high capacitances in a small package, but they tend to have strong voltage and temperature coefficients, as shown in Figures 4 and 5. When used with a 5V regulator, a 16V $10\mu\text{F}$ Y5V capacitor can exhibit an effective value as low as $1\mu\text{F}$ to $2\mu\text{F}$ for the DC bias voltage applied and over the operating temperature range. The X5R and X7R dielectrics result in more stable characteristics and are more suitable for use as the output capacitor. The X7R type has better stability across temperature, while the X5R is less expensive and is available in higher values. Care still must be exercised when using X5R and X7R capacitors; the X5R and X7R codes only specify operating temperature range and maximum capacitance change over temperature. Capacitance change due to DC bias with X5R and X7R capacitors is better than

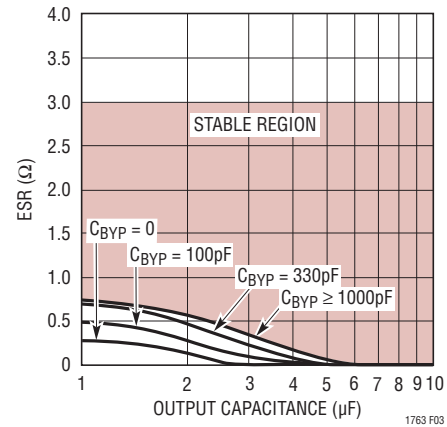

Figure 3. Stability

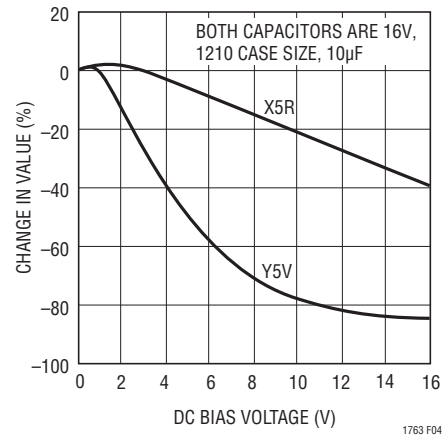

Figure 4. Ceramic Capacitor DC Bias Characteristics

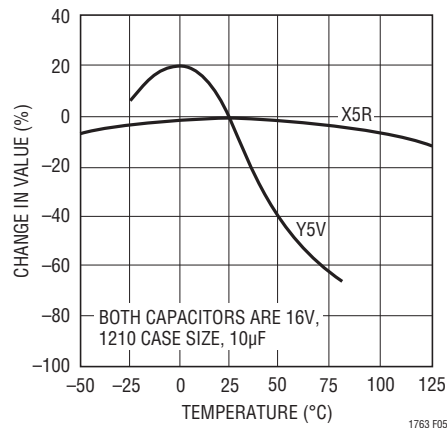

Figure 5. Ceramic Capacitor Temperature Characteristics

APPLICATIONS INFORMATION

Y5V and Z5U capacitors, but can still be significant enough to drop capacitor values below appropriate levels. Capacitor DC bias characteristics tend to improve as component case size increases, but expected capacitance at operating voltage should be verified.

Voltage and temperature coefficients are not the only sources of problems. Some ceramic capacitors have a piezoelectric response. A piezoelectric device generates voltage across its terminals due to mechanical stress, similar to the way a piezoelectric accelerometer or microphone works. For a ceramic capacitor, the stress can be induced by vibrations in the system or thermal transients. The resulting voltages produced can cause appreciable amounts of noise, especially when a ceramic capacitor is used for noise bypassing. A ceramic capacitor produced Figure 6's trace in response to light tapping from a pencil. Similar vibration induced behavior can masquerade as increased output voltage noise.

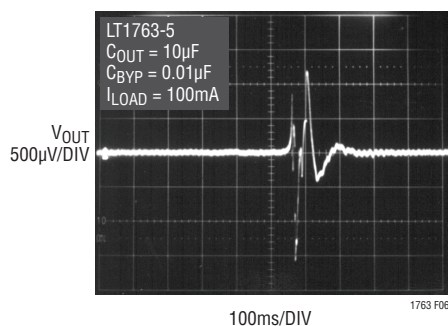

Figure 6. Noise Resulting from Tapping on a Ceramic Capacitor

Thermal Considerations

The power handling capability of the device will be limited by the maximum rated junction temperature (125°C). The power dissipated by the device will be made up of two components:

1. Output current multiplied by the input/output voltage differential: $(I_{OUT})(V_{IN} - V_{OUT})$, and
2. GND pin current multiplied by the input voltage: $(I_{GND})(V_{IN})$.

The GND pin current can be found by examining the GND Pin Current curves in the Typical Performance Characteristics section. Power dissipation will be equal to the sum of the two components listed above.

The LT1763 series regulators have internal thermal limiting designed to protect the device during overload conditions. For continuous normal conditions, the maximum junction temperature rating of 125°C must not be exceeded. It is important to give careful consideration to all sources of thermal resistance from junction-to-ambient. Additional heat sources mounted nearby must also be considered.

For surface mount devices, heat sinking is accomplished by using the heat spreading capabilities of the PC board and its copper traces. Copper board stiffeners and plated through-holes can also be used to spread the heat generated by power devices.

The following tables list thermal resistance for several different board sizes and copper areas. All measurements were taken in still air on 3/32" FR-4 board with one ounce copper.

Table 1. DE Package, 12-Lead DFN

| COPPER AREA | | BOARD AREA | THERMAL RESISTANCE (JUNCTION-TO-AMBIENT) |
|---------------------|---------------------|---------------------|--|
| TOPSIDE* | BACKSIDE | | |
| 2500mm ² | 2500mm ² | 2500mm ² | 40°C/W |
| 1000mm ² | 2500mm ² | 2500mm ² | 45°C/W |
| 225mm ² | 2500mm ² | 2500mm ² | 50°C/W |
| 100mm ² | 2500mm ² | 2500mm ² | 60°C/W |

* Device is mounted on top side

APPLICATIONS INFORMATION

Table 2. SO-8 Package, 8-Lead SO

| COPPER AREA | | BOARD AREA | THERMAL RESISTANCE (JUNCTION-TO-AMBIENT) |
|---------------------|---------------------|---------------------|---|
| TOPSIDE* | BACKSIDE | | |
| 2500mm ² | 2500mm ² | 2500mm ² | 60°C/W |
| 1000mm ² | 2500mm ² | 2500mm ² | 60°C/W |
| 225mm ² | 2500mm ² | 2500mm ² | 68°C/W |
| 100mm ² | 2500mm ² | 2500mm ² | 74°C/W |
| 50mm ² | 2500mm ² | 2500mm ² | 86°C/W |

* Device is mounted on top side

Calculating Junction Temperature

Example: Given an output voltage of 3.3V, an input voltage range of 4V to 6V, an output current range of 0mA to 250mA and a maximum ambient temperature of 50°C, what will the maximum junction temperature be?

The power dissipated by the device will be equal to:

$$I_{OUT(MAX)}(V_{IN(MAX)} - V_{OUT}) + I_{GND}(V_{IN(MAX)})$$

where,

$$I_{OUT(MAX)} = 250\text{mA}$$

$$V_{IN(MAX)} = 6\text{V}$$

$$I_{GND} \text{ at } (I_{OUT} = 250\text{mA}, V_{IN} = 6\text{V}) = 5\text{mA}$$

So,

$$P = 250\text{mA}(6\text{V} - 3.3\text{V}) + 5\text{mA}(6\text{V}) = 0.71\text{W}$$

The thermal resistance will be in the range of 60°C/W to 86°C/W, depending on the copper area. So, the junction temperature rise above ambient will be approximately equal to:

$$0.71\text{W}(75^\circ\text{C/W}) = 53.3^\circ\text{C}$$

The maximum junction temperature will then be equal to the maximum junction temperature rise above ambient plus the maximum ambient temperature, or:

$$T_{JMAX} = 50^\circ\text{C} + 53.3^\circ\text{C} = 103.3^\circ\text{C}$$

Protection Features

The LT1763 regulators incorporate several protection features which make them ideal for use in battery-powered circuits. In addition to the normal protection features associated with monolithic regulators, such as current limiting and thermal limiting, the devices are protected against reverse input voltages, reverse output voltages and reverse voltages from output to input.

Current limit protection and thermal overload protection are intended to protect the device against current overload conditions at the output of the device. For normal operation, the junction temperature should not exceed 125°C.

The input of the device will withstand reverse voltages of 20V. Current flow into the device will be limited to less than 1mA (typically less than 100µA) and no negative voltage will appear at the output. The device will protect both itself and the load. This provides protection against batteries which can be plugged in backward.

The output of the LT1763-X can be pulled below ground without damaging the device. If the input is left open-circuit or grounded, the output can be pulled below ground by 20V. For fixed voltage versions, the output will act like a large resistor, typically 500k or higher, limiting current flow to less than 100µA. For adjustable versions, the output will act like an open circuit; no current will flow out of the pin. If the input is powered by a voltage source, the output will source the short-circuit current of the device and will protect itself by thermal limiting. In this case, grounding the $\overline{\text{SHDN}}$ pin will turn off the device and stop the output from sourcing the short-circuit current.

The ADJ pin of the adjustable device can be pulled above or below ground by as much as 7V without damaging the device. If the input is left open-circuit or grounded, the ADJ pin will act like an open circuit when pulled below ground and like a large resistor (typically 100k) in series with a diode when pulled above ground.

In situations where the ADJ pin is connected to a resistor divider that would pull the ADJ pin above its 7V clamp voltage if the output is pulled high, the ADJ pin input current must be limited to less than 5mA. For example, a resistor divider is used to provide a regulated 1.5V output from the 1.22V reference when the output is forced to 20V.

APPLICATIONS INFORMATION

The top resistor of the resistor divider must be chosen to limit the current into the ADJ pin to less than 5mA when the ADJ pin is at 7V. The 13V difference between output and ADJ pin divided by the 5mA maximum current into the ADJ pin yields a minimum top resistor value of 2.6k.

In circuits where a backup battery is required, several different input/output conditions can occur. The output voltage may be held up while the input is either pulled to ground, pulled to some intermediate voltage or is left open-circuit. Current flow back into the output will follow the curve shown in Figure 7.

When the IN pin of the LT1763-X is forced below the OUT pin, or the OUT pin is pulled above the IN pin, input current will typically drop to less than 2 μ A. This can happen if the input of the device is connected to a discharged (low voltage) battery and the output is held up by either a backup battery or a second regulator circuit. The state of the SHDN pin will have no effect on the reverse output current when the output is pulled above the input.

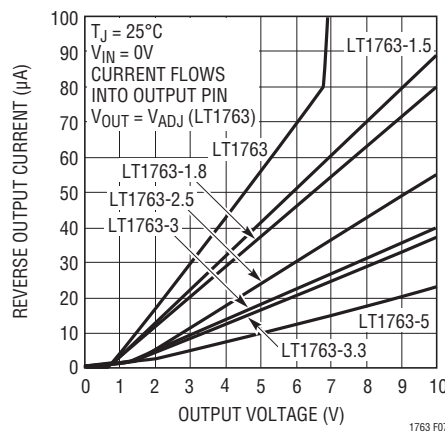
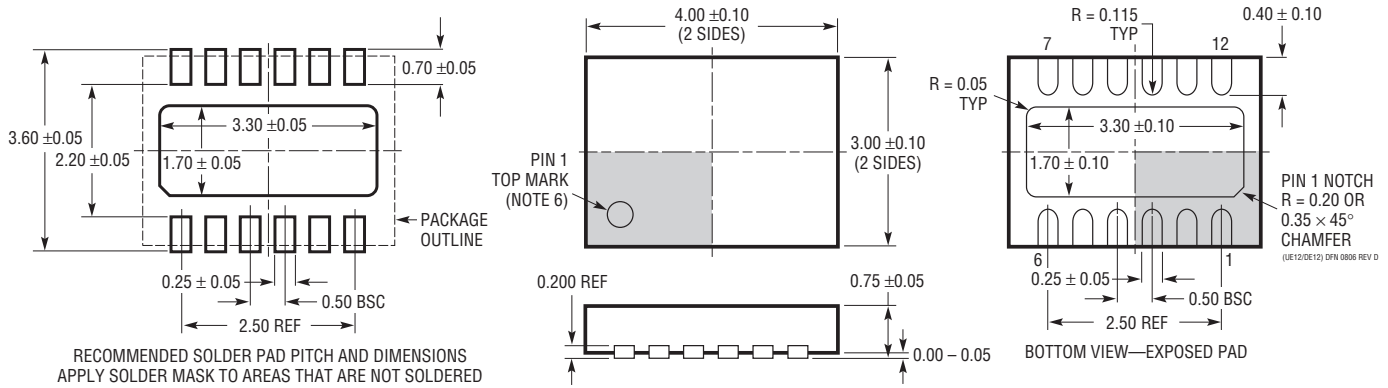

Figure 7. Reverse Output Current

PACKAGE DESCRIPTION

DE/UE Package 12-Lead Plastic DFN (4mm × 3mm) (Reference LTC DWG # 05-08-1695 Rev D)



RECOMMENDED SOLDER PAD PITCH AND DIMENSIONS
APPLY SOLDER MASK TO AREAS THAT ARE NOT SOLDERED

NOTE:

1. DRAWING PROPOSED TO BE A VARIATION OF VERSION (WGED) IN JEDEC PACKAGE OUTLINE MO-229
2. DRAWING NOT TO SCALE
3. ALL DIMENSIONS ARE IN MILLIMETERS
4. DIMENSIONS OF EXPOSED PAD ON BOTTOM OF PACKAGE DO NOT INCLUDE MOLD FLASH. MOLD FLASH, IF PRESENT, SHALL NOT EXCEED 0.15mm ON ANY SIDE
5. EXPOSED PAD SHALL BE SOLDER PLATED
6. SHADED AREA IS ONLY A REFERENCE FOR PIN 1 LOCATION ON THE TOP AND BOTTOM OF PACKAGE

S8 Package 8-Lead Plastic Small Outline (Narrow .150 Inch) (Reference LTC DWG # 05-08-1610)

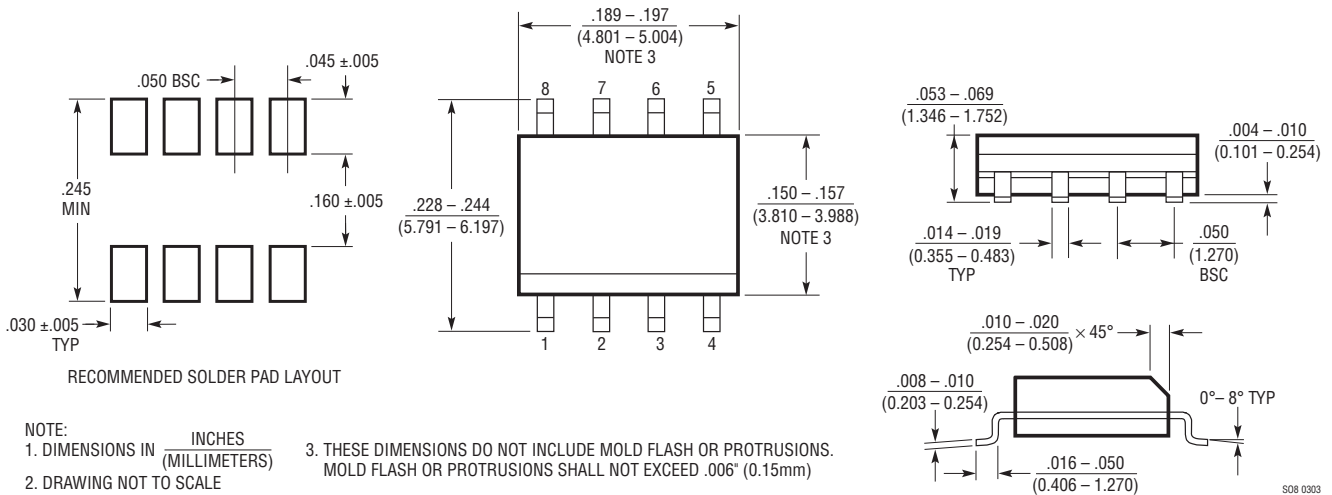

RECOMMENDED SOLDER PAD LAYOUT

NOTE:

1. DIMENSIONS IN $\frac{\text{INCHES}}{\text{MILLIMETERS}}$
2. DRAWING NOT TO SCALE
3. THESE DIMENSIONS DO NOT INCLUDE MOLD FLASH OR PROTRUSIONS. MOLD FLASH OR PROTRUSIONS SHALL NOT EXCEED $.006$ " (0.15 mm)

S08 0303

REVISION HISTORY (Revision history begins at Rev G)

| REV | DATE | DESCRIPTION | PAGE NUMBER |
|-----|------|---|-------------|
| G | 5/10 | Updated Order Information to add MP-grade to all versions of DFN package | 2 to 4 |
| | | Revised Line Regulation section of Electrical Characteristics | 5 |
| | | Consolidated GND and exposed pad descriptions in Pin Descriptions section | 14 |
| | | Added LT3085 to Related Parts | 22 |

TYPICAL APPLICATION

Paralleling of Regulators for Higher Output Current

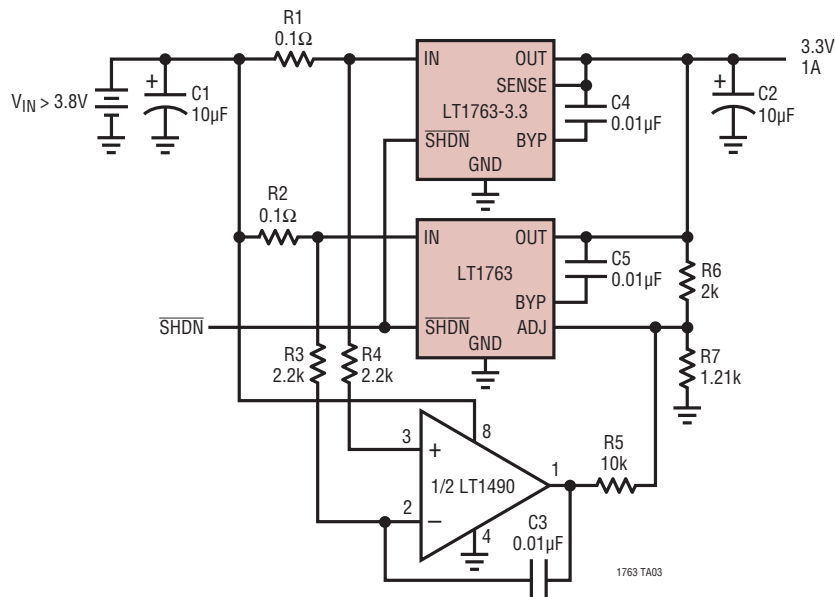

RELATED PARTS

| PART NUMBER | DESCRIPTION | COMMENTS |
|---------------|---|---|
| LT1120 | 125mA Low Dropout Regulator with 20µA I _Q | Includes 2.5V Reference and Comparator |
| LT1121 | 150mA Micropower Low Dropout Regulator | 30µA I _Q , SOT-223 Package |
| LT1129 | 700mA Micropower Low Dropout Regulator | 50µA Quiescent Current |
| LT1175 | 500mA Negative Low Dropout Micropower Regulator | 45µA I _Q , 0.26V Dropout Voltage, SOT-223 Package |
| LT1521 | 300mA Low Dropout Micropower Regulator with Shutdown | 15µA I _Q , Reverse Battery Protection |
| LT1529 | 3A Low Dropout Regulator with 50µA I _Q | 500mV Dropout Voltage |
| LT1613 | 1.4MHz Single-Cell Micropower DC/DC Converter | SOT-23 Package, Internally Compensated |
| LT1761 Series | 100mA, Low Noise, Low Dropout Micropower Regulators in SOT-23 | 20µA Quiescent Current, 20µV _{RMS} Noise, ThinSOT™ |
| LT1762 Series | 150mA, Low Noise, LDO Micropower Regulators | 25µA Quiescent Current, 20µV _{RMS} Noise, MS8 |
| LT1764A | 3A, Fast Transient Response Low Dropout Regulator | 340mV Dropout Voltage, DD, TO220 |
| LT1962 | 300mA, Fast Transient Response Low Dropout Regulator | 270mV Dropout Voltage, 20µV _{RML} , MS8 |
| LT1963A | 1.5A, Fast Transient Response Low Dropout Regulator | 340mV Dropout Voltage, 40µV _{RML} , DD, TO220, S8, SOT-223 |
| LT3010 | 50mA, 80V Low Noise, LDO Micropower Regulator | 300mV Dropout Voltage, MS8E |
| LT3021 | 500mA, Low Voltage, Very Low Dropout Linear Regulator | 160mV Dropout Voltage, DFN-8 and SOIC-8 Packages |
| LT3085 | 500mA Parallelable, Low Noise, Low Dropout Linear Regulator | 275mV Dropout Voltage (2 Supply Operation), MSOP-8 and 2mm × 3mm DFN-6 Packages |