

5MHz, 3V/ μ s, Low Power Single Supply, Dual and Quad Precision Op Amps

FEATURES

- **Gain-Bandwidth Product: 5MHz Typ**
- **Slew Rate: 3V/ μ s Typ**
- **Low Supply Current per Amplifier: 0.55mA Max**
- **Input Offset Voltage: 180 μ V Max**
- Input Offset Voltage Drift: 3 μ V/ $^{\circ}$ C Max
- Input Offset Current: 20nA Max
- Input Bias Current: 100nA Max
- Open-Loop Gain: 1500V/mV Min ($V_S = \pm 15V$)
- Low Input Noise Voltage: 16.5nV/ \sqrt{Hz}
- Low Input Noise Current: 0.14pA/ \sqrt{Hz}
- Large Output Drive Current: 20mA Min
- Single Supply Operation
 - Input Voltage Range Includes Ground
 - Output Swings to Ground While Sinking Current
- Wide Supply Voltage Range: 2.5V to 36V
- Specified on 3.3V, 5V and $\pm 15V$
- Dual in 8-Pin PDIP and SO Package
- Quad in a Narrow 16-Pin SO Package

APPLICATIONS

- Battery-Powered Systems
 - Portable Instrumentation
- Active Filters
- Photodiode Amplifiers
- DAC Current to Voltage Amplifiers

DESCRIPTION

The LT[®]1492/LT1493 are dual/quad, low power, single supply precision op amps with 5MHz gain-bandwidth product, 3V/ μ s slew rate and only 450 μ A of quiescent supply current per amplifier.

With a maximum input offset voltage of only 180 μ V, the LT1492/LT1493 eliminate trims in most systems while providing high frequency performance not usually found in low power single supply amplifiers.

The LT1492/LT1493 will operate on any supply greater than 2.5V and less than 36V total, and are specified on single 3.3V, single 5V and $\pm 15V$ supplies. Even with their low quiescent supply current the minimum output drive is 20mA, ideal for driving low impedance loads.

The inputs can be driven beyond the supplies without damage or phase reversal of the output. The low operating voltage and wide input and output range make the LT1492/LT1493 amplifiers ideal for battery-powered applications.

For applications requiring faster precision single supply amplifiers, see the 14MHz, 7V/ μ s LT1211/LT1212, the 28MHz, 12V/ μ s LT1213/LT1214 or the 23MHz, 50V/ μ s LT1215/LT1216.

 LTC and LT are registered trademarks of Linear Technology Corporation.

TYPICAL APPLICATION

Precision AC to DC Converter (Full Wave Rectifier and Filter)

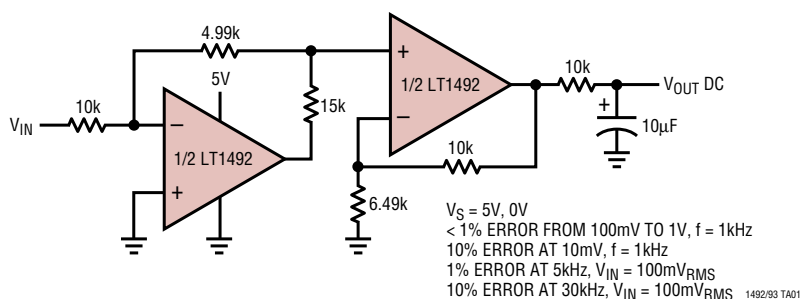

Distribution of Offset Voltage Drift with Temperature

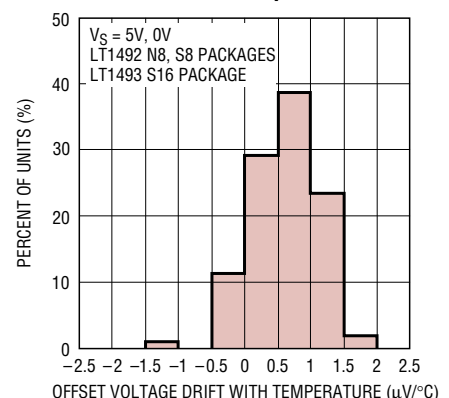

ABSOLUTE MAXIMUM RATINGS

Total Supply Voltage (V^+ to V^-) 36V
 Input Current $\pm 15\text{mA}$
 Output Short-Circuit Duration (Note 1) Continuous
 Operating Temperature Range -40°C to 85°C

Specified Temperature Range (Note 2) -40°C to 85°C
 Junction Temperature 150°C
 Storage Temperature Range -65°C to 150°C
 Lead Temperature (Soldering, 10 sec) 300°C

PACKAGE/ORDER INFORMATION

<p>N8 PACKAGE 8-LEAD PDIP S8 PACKAGE 8-LEAD PLASTIC SO</p> <p>$T_{JMAX} = 150^\circ\text{C}$, $\theta_{JA} = 130^\circ\text{C/W}$ (N8) $T_{JMAX} = 150^\circ\text{C}$, $\theta_{JA} = 190^\circ\text{C/W}$ (S8)</p>	ORDER PART NUMBER	<p>S PACKAGE 16-LEAD PLASTIC SO</p> <p>$T_{JMAX} = 150^\circ\text{C}$, $\theta_{JA} = 150^\circ\text{C/W}$</p>	ORDER PART NUMBER
	LT1492CN8 LT1492CS8		LT1493CS
	S8 PART MARKING		
	1492		

Consult factory for Industrial and Military grade parts.

5V ELECTRICAL CHARACTERISTICS

$V_S = 5\text{V}$, 0V ; $V_{CM} = 0.5\text{V}$, $V_{OUT} = 0.5\text{V}$, $T_A = 25^\circ\text{C}$, unless otherwise noted.

SYMBOL	PARAMETER	CONDITIONS	MIN	TYP	MAX	UNITS
V_{OS}	Input Offset Voltage			100	180	μV
$\frac{\Delta V_{OS}}{\Delta \text{Time}}$	Long-Term Input Offset Voltage Stability			0.6		$\mu\text{V}/\text{Mo}$
I_{OS}	Input Offset Current			5	20	nA
I_B	Input Bias Current			50	100	nA
	Input Noise Voltage	0.1Hz to 10Hz		330		nV _{p-p}
e_n	Input Noise Voltage Density	$f_0 = 10\text{Hz}$ $f_0 = 1000\text{Hz}$		17.3 16.5		nV/ $\sqrt{\text{Hz}}$ nV/ $\sqrt{\text{Hz}}$
i_n	Input Noise Current Density	$f_0 = 10\text{Hz}$ $f_0 = 1000\text{Hz}$		0.78 0.14		pA/ $\sqrt{\text{Hz}}$ pA/ $\sqrt{\text{Hz}}$
	Input Resistance (Note 3)	Differential Mode Common Mode	10	40 800		M Ω M Ω
	Input Capacitance	$f = 1\text{MHz}$		10		pF
	Input Voltage Range		3.4 0	3.60 -0.25		V V
CMRR	Common Mode Rejection Ratio	$V_{CM} = 0\text{V}$ to 3.4V	86	102		dB
PSRR	Power Supply Rejection Ratio	$V_S = 2.5\text{V}$ to 12.5V	90	110		dB

5V ELECTRICAL CHARACTERISTICS

$V_S = 5V, 0V; V_{CM} = 0.5V, V_{OUT} = 0.5V, T_A = 25^\circ C$, unless otherwise noted.

SYMBOL	PARAMETER	CONDITIONS	MIN	TYP	MAX	UNITS	
A_{VOL}	Large-Signal Voltage Gain	$V_O = 0.05V$ to $3.7V, R_L = 2k$	175	350		V/mV	
	Maximum Output Voltage Swing (Note 4)	Output High, No Load	4.2	4.35		V	
		Output High, $I_{SOURCE} = 1mA$	4.1	4.25		V	
		Output High, $I_{SOURCE} = 15mA$	3.0	3.15		V	
		Output Low, No Load		0.003	0.006		V
		Output Low, $I_{SINK} = 1mA$		0.062	0.075		V
		Output Low, $I_{SINK} = 15mA$		0.362	0.500		V
I_O	Maximum Output Current (Note 8)		± 20	± 60		mA	
SR	Slew Rate	$A_V = -2$		1.8		V/ μs	
GBW	Gain-Bandwidth Product	$f = 100kHz$		4.5		MHz	
I_S	Supply Current per Amplifier			425	550	μA	
	Minimum Supply Voltage			2.1	2.5	V	
	Full Power Bandwidth	$A_V = 1, V_O = 2.5V_{P-P}$		150		kHz	
t_r, t_f	Rise Time, Fall Time	$A_V = 1, 10\%$ to $90\%, V_O = 100mV$		100		ns	
OS	Overshoot	$A_V = 1, V_O = 100mV$		20		%	
t_{PD}	Propagation Delay	$A_V = 1, V_O = 100mV$		100		ns	
t_S	Settling Time	$0.01\%, A_V = 1, \Delta V_O = 2V$		2.6		μs	
	Open-Loop Output Resistance	$I_O = 0mA, f = 2MHz$		130		Ω	
THD	Total Harmonic Distortion	$A_V = 1, V_O = 1V_{RMS}, f = 20Hz$ to $20kHz$		0.005		%	

$V_S = 5V, 0V; V_{CM} = 0.5V, V_{OUT} = 0.5V, 0^\circ C \leq T_A \leq 70^\circ C$, unless otherwise noted.

SYMBOL	PARAMETER	CONDITIONS	MIN	TYP	MAX	UNITS	
V_{OS}	Input Offset Voltage		●	120	280	μV	
$\frac{V_{OS}}{\Delta T}$	Input Offset Voltage Drift (Note 3)		●	1	3	$\mu V/^\circ C$	
I_{OS}	Input Offset Current		●	5	25	nA	
I_B	Input Bias Current		●	55	110	nA	
	Input Voltage Range		●	3.4	3.55	V	
			●	0	-0.15	V	
CMRR	Common Mode Rejection Ratio	$V_{CM} = 0V$ to $3.4V$	●	84	102	dB	
PSRR	Power Supply Rejection Ratio	$V_S = 2.5V$ to $12.5V$	●	90	110	dB	
A_{VOL}	Large-Signal Voltage Gain	$V_O = 0.05V$ to $3.7V, R_L = 2k$	●	140	250	V/mV	
	Maximum Output Voltage Swing (Note 4)	Output High, No Load	●	4.1	4.25	V	
		Output High, $I_{SOURCE} = 1mA$	●	4.0	4.15	V	
		Output High, $I_{SOURCE} = 15mA$	●	2.9	3.05	V	
		Output Low, No Load	●		0.004	0.007	V
		Output Low, $I_{SINK} = 1mA$	●		0.070	0.085	V
		Output Low, $I_{SINK} = 15mA$	●		0.390	0.525	V
I_S	Supply Current per Amplifier		●	470	650	μA	

5V ELECTRICAL CHARACTERISTICS

$V_S = 5V, 0V; V_{CM} = 0.5V, V_{OUT} = 0.5V, -40^\circ C \leq T_A \leq 85^\circ C$, unless otherwise noted. (Note 2)

SYMBOL	PARAMETER	CONDITIONS	MIN	TYP	MAX	UNITS	
V_{OS}	Input Offset Voltage			150	325	μV	
$\frac{V_{OS}}{\Delta T}$	Input Offset Voltage Drift (Note 3)			1	3	$\mu V/^\circ C$	
I_{OS}	Input Offset Current			5	40	nA	
I_B	Input Bias Current			55	130	nA	
	Input Voltage Range		3.4 0	3.5 -0.1		V V	
CMRR	Common Mode Rejection Ratio	$V_{CM} = 0V$ to 3.4V		80	90	dB	
PSRR	Power Supply Rejection Ratio	$V_S = 2.5V$ to 12.5V		90	110	dB	
A_{VOL}	Large-Signal Voltage Gain	$V_O = 0.05V$ to 3.7V, $R_L = 2k$		140	220	V/mV	
	Maximum Output Voltage Swing (Note 4)	Output High, No Load		3.95	4.15	V	
		Output High, $I_{SOURCE} = 1mA$		3.85	4.05	V	
		Output High, $I_{SOURCE} = 15mA$		2.75	2.95	V	
		Output Low, No Load			0.005	0.008	V
		Output Low, $I_{SINK} = 1mA$			0.073	0.095	V
		Output Low, $I_{SINK} = 15mA$			0.400	0.575	V
I_S	Supply Current per Amplifier			480	700	μA	

$\pm 15V$ ELECTRICAL CHARACTERISTICS

$V_S = \pm 15V, V_{CM} = 0V, V_{OUT} = 0V, T_A = 25^\circ C$, unless otherwise noted.

SYMBOL	PARAMETER	CONDITIONS	MIN	TYP	MAX	UNITS
V_{OS}	Input Offset Voltage			120	450	μV
I_{OS}	Input Offset Current			5	20	nA
I_B	Input Bias Current			45	100	nA
	Input Voltage Range		13.4 -15.0	13.6 -15.2		V V
CMRR	Common Mode Rejection Ratio	$V_{CM} = -15V$ to 13.4V		86	102	dB
PSRR	Power Supply Rejection Ratio	$V_S = \pm 2V$ to $\pm 16V$		90	113	dB
A_{VOL}	Large-Signal Voltage Gain	$V_O = \pm 10V, R_L = 5k$		1500	6500	V/mV
	Maximum Output Voltage Swing	Output High, $I_{SOURCE} = 15mA$		12.9	13.15	V
		Output Low, $I_{SINK} = 15mA$		-14.4	-14.6	V
I_O	Maximum Output Current	(Note 8)	± 20	± 55		mA
SR	Slew Rate	$A_V = -2$, (Note 5)	2	3		V/ μs
GBW	Gain-Bandwidth Product	$f = 100kHz$	3	5		MHz
I_S	Supply Current per Amplifier			500	800	μA
	Channel Separation	$V_O = \pm 10V, R_L = 5k$	128	140		dB
	Minimum Supply Voltage			± 1.4	± 2	V
	Full Power Bandwidth	$A_V = 1, V_O = 20V_{P-P}$		30		kHz
t_S	Settling Time	0.01%, $A_V = 1, \Delta V_O = 10V$		5.8		μs

±15V ELECTRICAL CHARACTERISTICS

$V_S = \pm 15V$, $V_{CM} = 0V$, $V_{OUT} = 0V$, $0^\circ C \leq T_A \leq 70^\circ C$, unless otherwise noted.

SYMBOL	PARAMETER	CONDITIONS	MIN	TYP	MAX	UNITS
V_{OS}	Input Offset Voltage			160	550	μV
$\frac{V_{OS}}{\Delta T}$	Input Offset Voltage Drift (Note 3)			1	3	$\mu V/^\circ C$
I_{OS}	Input Offset Current			10	30	nA
I_B	Input Bias Current			55	120	nA
	Input Voltage Range		13.4 -15.0	13.5 -15.1		V V
CMRR	Common Mode Rejection Ratio	$V_{CM} = -15V$ to $13.4V$		84	101	dB
PSRR	Power Supply Rejection Ratio	$V_S = \pm 2V$ to $\pm 16V$		90	108	dB
A_{VOL}	Large-Signal Voltage Gain	$V_O = \pm 10V$, $R_L = 5k$		1200	4000	V/mV
	Maximum Output Voltage Swing	Output High, $I_{SOURCE} = 15mA$ Output Low, $I_{SINK} = 15mA$		12.7 -14.2	13.0 -14.6	V V
I_S	Supply Current per Amplifier			600	930	μA

$V_S = \pm 15V$, $V_{CM} = 0V$, $V_{OUT} = 0V$, $-40^\circ C \leq T_A \leq 85^\circ C$, unless otherwise noted. (Note 2)

SYMBOL	PARAMETER	CONDITIONS	MIN	TYP	MAX	UNITS
V_{OS}	Input Offset Voltage			180	650	μV
$\frac{V_{OS}}{\Delta T}$	Input Offset Voltage Drift (Note 3)			1	3	$\mu V/^\circ C$
I_{OS}	Input Offset Current			10	50	nA
I_B	Input Bias Current			55	150	nA
	Input Voltage Range		13.4 -15.0	13.45 -15.05		V V
CMRR	Common Mode Rejection Ratio	$V_{CM} = -15V$ to $13.4V$		82	101	dB
PSRR	Power Supply Rejection Ratio	$V_S = \pm 2V$ to $\pm 16V$		90	108	dB
A_{VOL}	Large-Signal Voltage Gain	$V_O = \pm 10V$, $R_L = 5k$		1000	3500	V/mV
	Maximum Output Voltage Swing	Output High, $I_{SOURCE} = 15mA$ Output Low, $I_{SINK} = 15mA$		12.5 -14.1	12.9 -14.6	V V
I_S	Supply Current per Amplifier			620	1000	μA

3.3V ELECTRICAL CHARACTERISTICS

$V_S = 3.3V, 0V; V_{CM} = 0.5V, V_{OUT} = 0.5V, T_A = 25^\circ C$, unless otherwise noted. (Note 6)

SYMBOL	PARAMETER	CONDITIONS	MIN	TYP	MAX	UNITS
V_{OS}	Input Offset Voltage			100	180	μV
	Input Voltage Range (Note 7)		1.7 0	1.9 -0.2		V V
	Maximum Output Voltage Swing	Output High, No Load	2.50	2.65		V
		Output High, $I_{SOURCE} = 1mA$	2.40	2.55		V
		Output High, $I_{SOURCE} = 15mA$	1.30	1.45		V
	Output Low, No Load			0.003	0.006	V
		Output Low, $I_{SINK} = 1mA$		0.062	0.075	V
		Output Low, $I_{SINK} = 15mA$		0.362	0.500	V
I_O	Maximum Output Current		± 20	± 50	mA	

$V_S = 3.3V, 0V; V_{CM} = 0.5V, V_{OUT} = 0.5V, 0^\circ C \leq T_A \leq 70^\circ C$, unless otherwise noted. (Note 6)

SYMBOL	PARAMETER	CONDITIONS	MIN	TYP	MAX	UNITS
V_{OS}	Input Offset Voltage			120	280	μV
	Input Voltage Range (Note 7)		1.7 0	1.8 -0.1		V V
	Maximum Output Voltage Swing	Output High, No Load	2.4	2.55		V
		Output High, $I_{SOURCE} = 1mA$	2.3	2.45		V
		Output High, $I_{SOURCE} = 15mA$	1.2	1.35		V
	Output Low, No Load			0.004	0.007	V
		Output Low, $I_{SINK} = 1mA$		0.070	0.085	V
		Output Low, $I_{SINK} = 15mA$		0.390	0.525	V

$V_S = 3.3V, 0V; V_{CM} = 0.5V, V_{OUT} = 0.5V, -40^\circ C \leq T_A \leq 85^\circ C$, unless otherwise noted. (Notes 2, 6)

SYMBOL	PARAMETER	CONDITIONS	MIN	TYP	MAX	UNITS
V_{OS}	Input Offset Voltage			150	325	μV
	Input Voltage Range (Note 7)		1.7 0	1.75 -0.05		V V
	Maximum Output Voltage Swing	Output High, No Load	2.25	2.45		V
		Output High, $I_{SOURCE} = 1mA$	2.15	2.35		V
		Output High, $I_{SOURCE} = 15mA$	1.05	1.25		V
	Output Low, No Load			0.005	0.008	V
		Output Low, $I_{SINK} = 1mA$		0.073	0.095	V
		Output Low, $I_{SINK} = 15mA$		0.400	0.575	V

The ● denotes specifications that apply over the full operating temperature range.

Note 1: A heat sink may be required to keep the junction temperature below absolute maximum when the output is shorted indefinitely.

Note 2: The LT1492/LT1493 are designed, characterized and expected to meet these extended temperature limits, but are not tested at $-40^\circ C$ and $85^\circ C$. Guaranteed I grade parts are available. Consult factory.

Note 3: This parameter is not 100% tested.

Note 4: Guaranteed by correlation to $V_S = 3.3V$ and $V_S = \pm 15V$ tests.

Note 5: Slew rate is measured between $\pm 5V$ on an output swing of $\pm 10V$ on $\pm 15V$ supplies.

Note 6: Most LT1492/LT1493 electrical characteristics change very little with supply voltage. See the 5V tables for characteristics not listed in the 3.3V table.

Note 7: Guaranteed by correlation to $V_S = 5V$ and $V_S = \pm 15V$ tests.

Note 8: Guaranteed by correlation to $V_S = 3.3V$ tests.

TYPICAL PERFORMANCE CHARACTERISTICS

Distribution of Input Offset Voltage

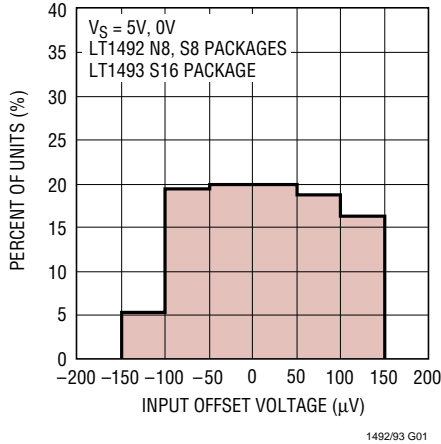

Distribution of Offset Voltage Drift with Temperature

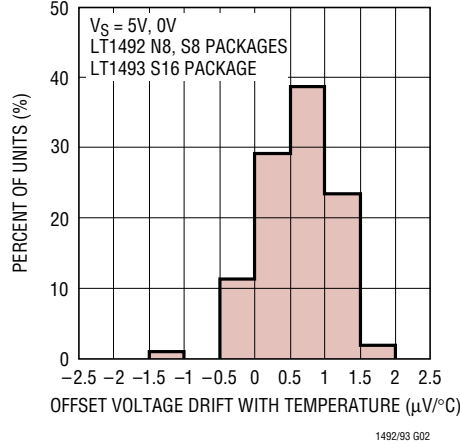

Distribution of Input Offset Voltage

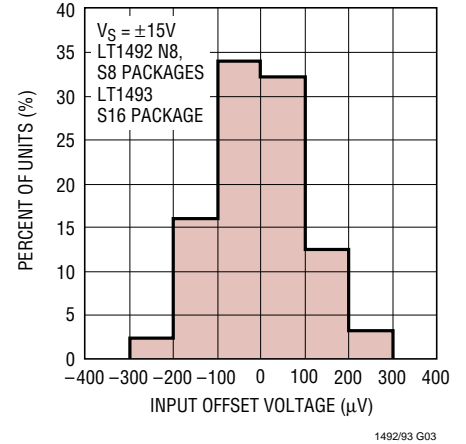

Voltage Gain, Phase vs Frequency

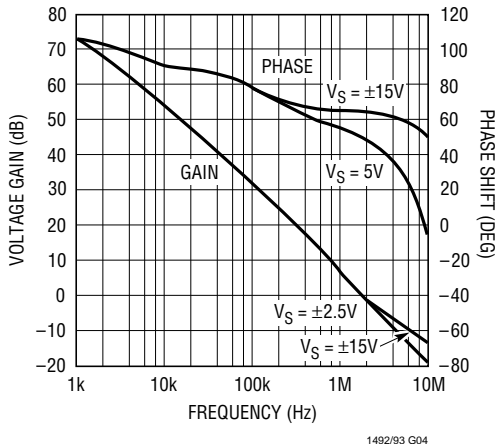

Gain-Bandwidth Product, Phase Margin vs Supply Voltage

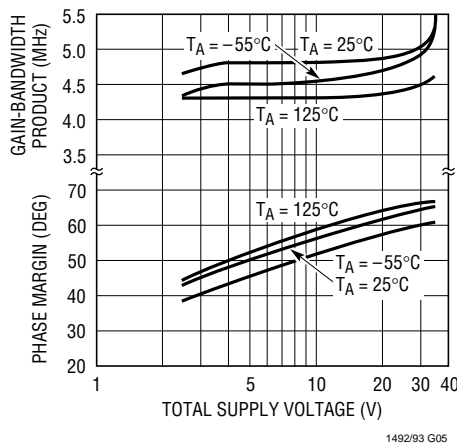

Slew Rate vs Temperature

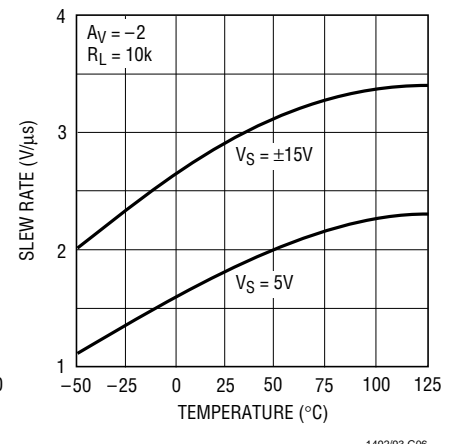

Slew Rate vs Supply Voltage

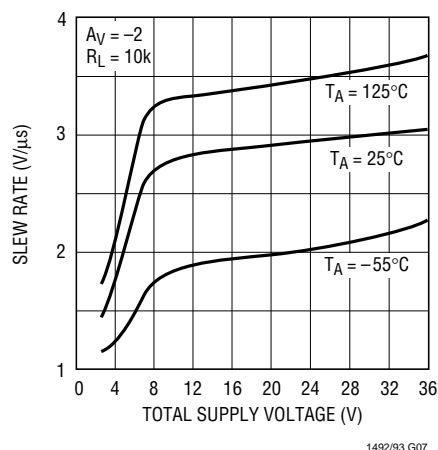

Capacitive Load Handling

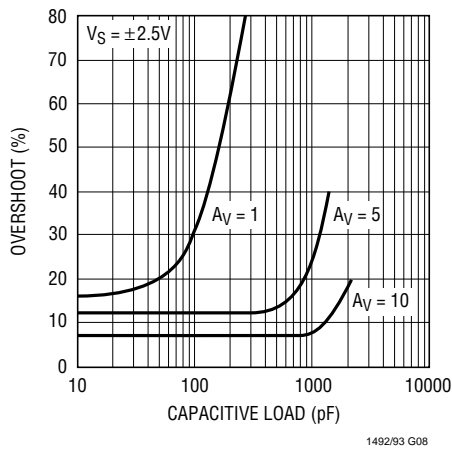

Undistorted Output Swing vs Frequency, VS = ±2.5V

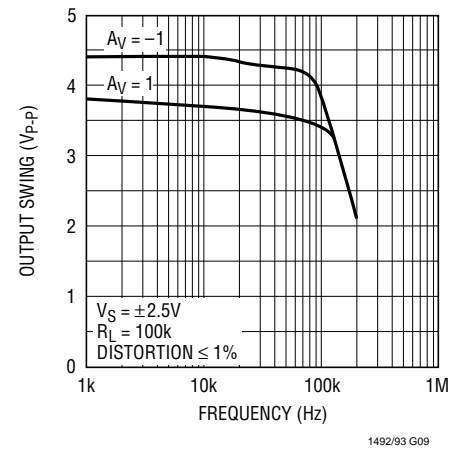

TYPICAL PERFORMANCE CHARACTERISTICS

Undistorted Output Swing vs Frequency, $V_S = \pm 15V$

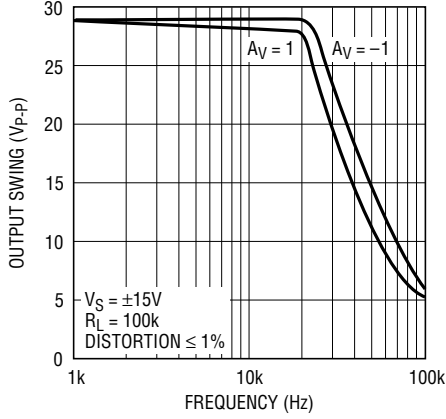

1492/93 G10

Total Harmonic Distortion and Noise vs Frequency

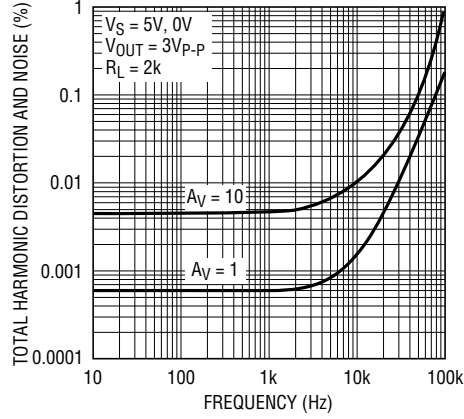

1492/93 G11

Open-Loop Voltage Gain vs Supply Voltage

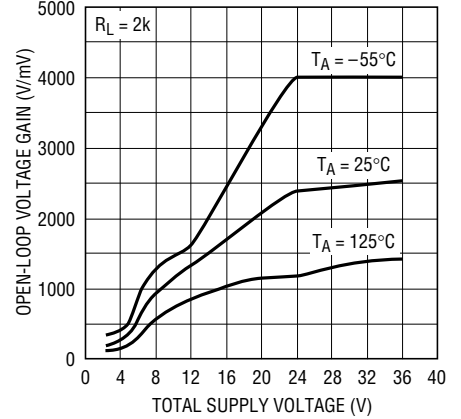

1492/93 G12

Open-Loop Gain, $V_S = 5V$

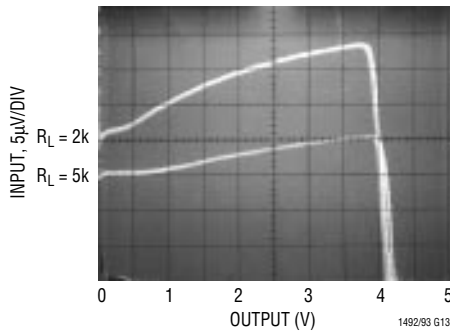

1492/93 G13

Positive Output Saturation Voltage vs Load Current

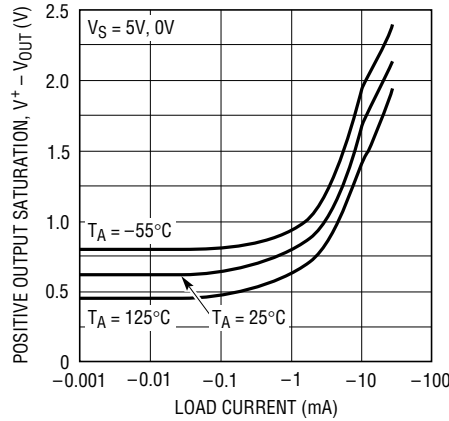

1492/93 G14

Voltage Gain vs Load Resistance

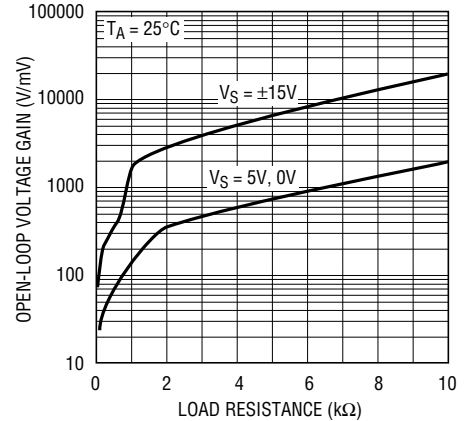

1492/93 G15

Open-Loop Gain, $V_S = \pm 15V$

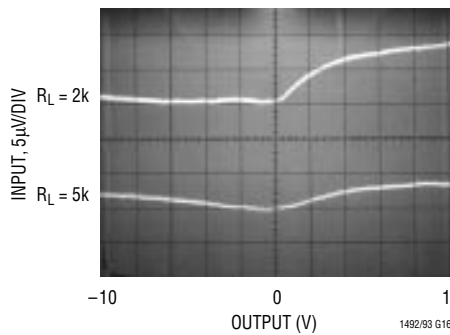

1492/93 G16

Negative Output Saturation Voltage vs Load Current

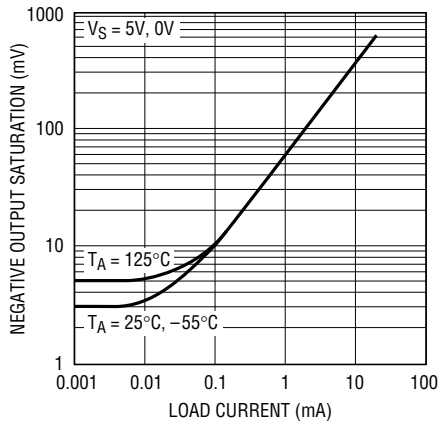

1492/93 G17

Channel Separation vs Frequency

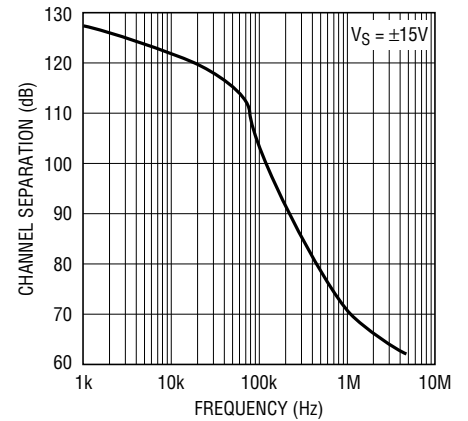

1492/93 G18

TYPICAL PERFORMANCE CHARACTERISTICS

Output Short-Circuit Current vs Temperature

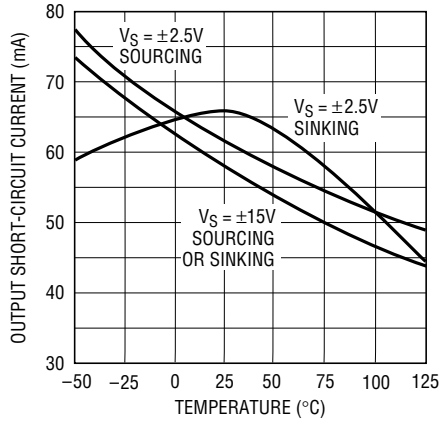

1492/93 G19

Output Impedance vs Frequency

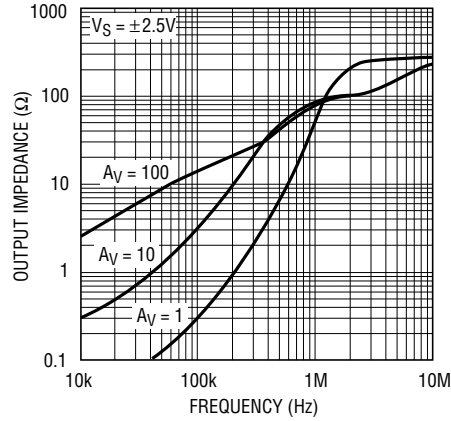

1492/93 G20

5V Small-Signal Response

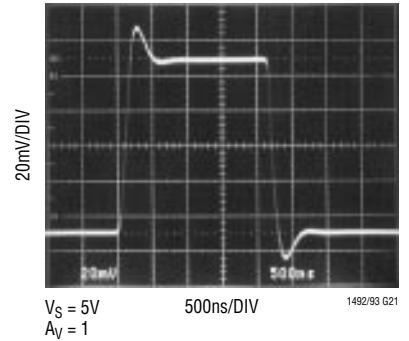

$V_S = 5V$
 $A_V = 1$
1492/93 G21

5V Large-Signal Response

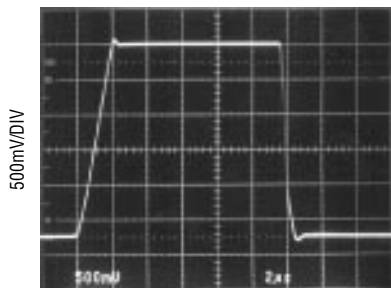

$V_S = 5V$
 $A_V = 1$
1492/93 G22

5V Large-Signal Response

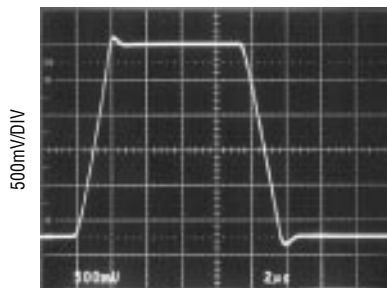

$V_S = 5V$
 $A_V = -1$
 $R_F = R_G = 2k$
1492/93 G23

±15V Small-Signal Response

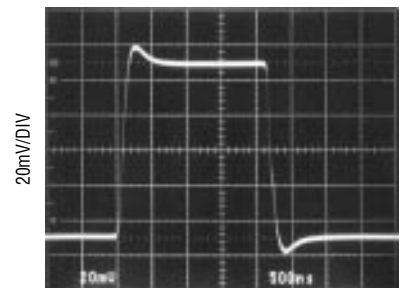

$V_S = ±15V$
 $A_V = 1$
1492/93 G24

±15V Large-Signal Response

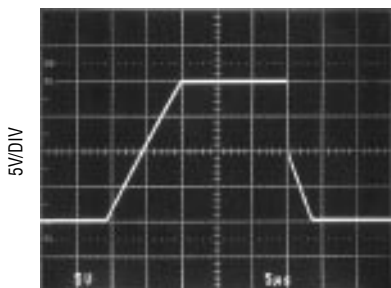

$V_S = ±15V$
 $A_V = 1$
1492/93 G25

±15V Large-Signal Response

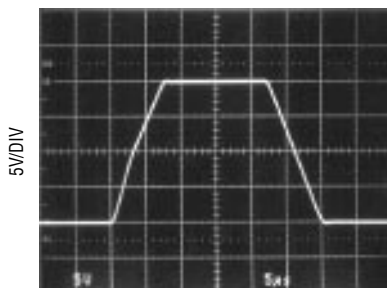

$V_S = ±15V$
 $A_V = -1$
 $R_F = R_G = 2k$
1492/93 G26

Settling Time to 1mV vs Output Step

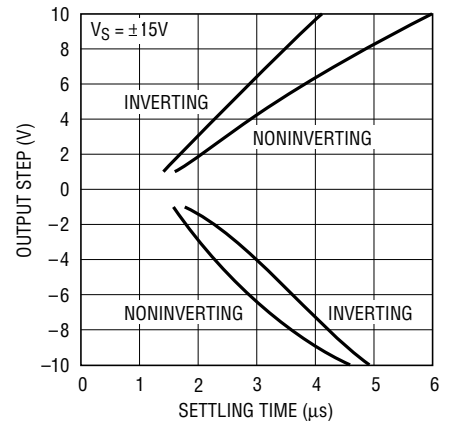

1492/93 G27

TYPICAL PERFORMANCE CHARACTERISTICS

Supply Current vs Temperature

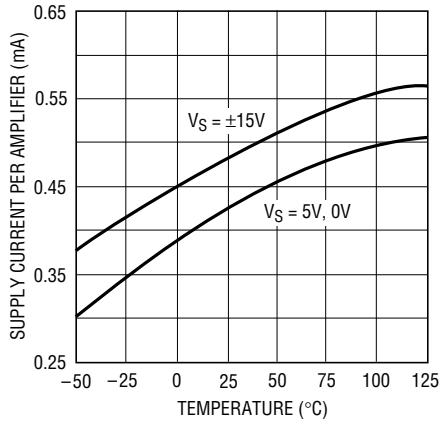

1492/93 G28

Supply Current vs Supply Voltage

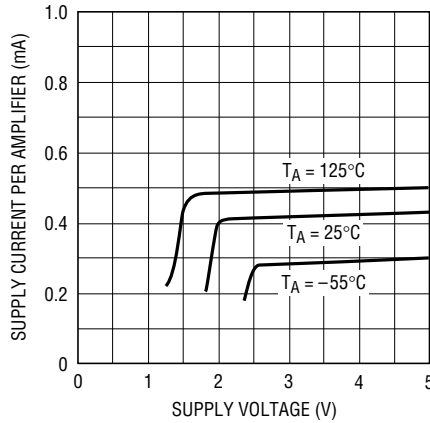

1492/93 G29

Warm-Up Drift vs Time

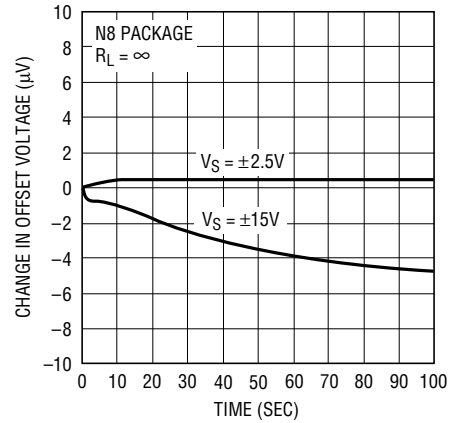

1492/93 G30

Input Bias Current vs Temperature

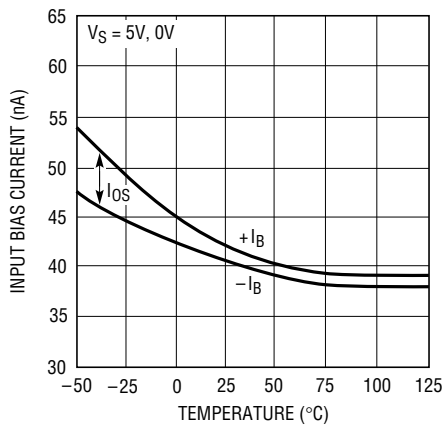

1492/93 G31

Input Bias Current vs Common Mode Voltage

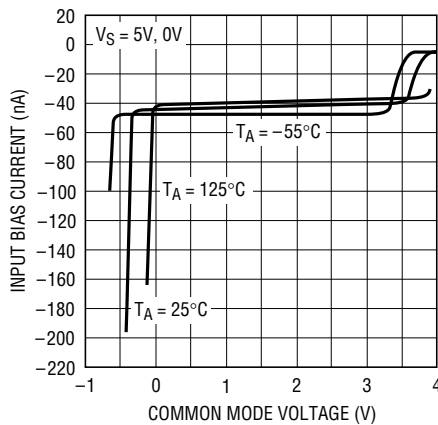

1492/93 G32

Common Mode Range vs Temperature

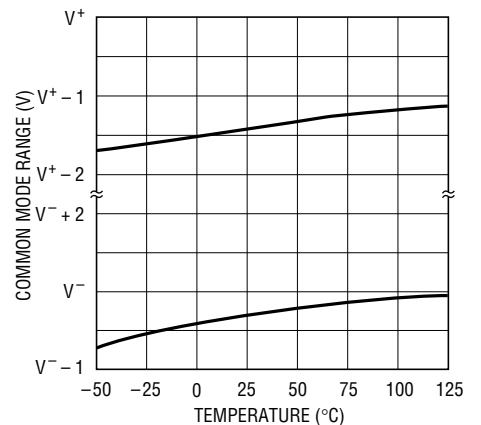

1492/93 G33

Input Noise Current, Noise Voltage Density vs Frequency

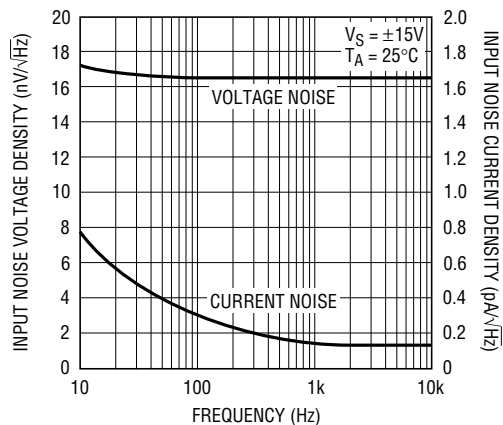

1492/93 G34

Common Mode Rejection Ratio vs Frequency

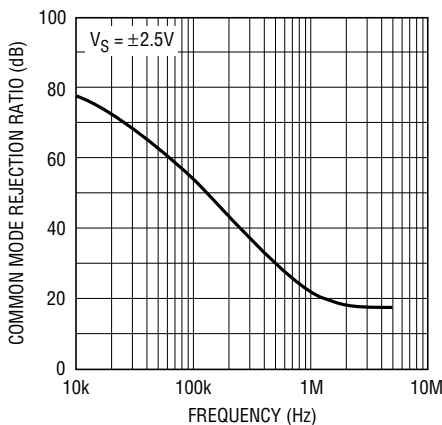

1492/93 G35

Input Referred Power Supply Rejection Ratio vs Frequency

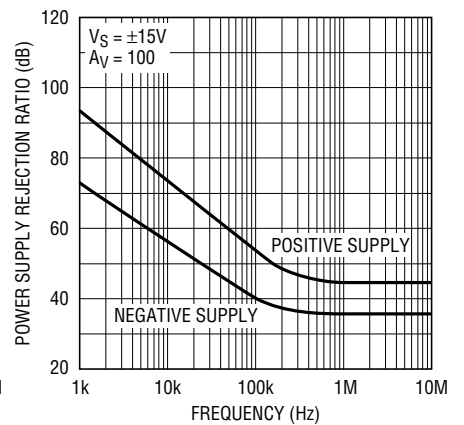

1492/93 G26

APPLICATIONS INFORMATION

Supply Voltage

The LT1492/LT1493 op amps are fully functional and all internal bias circuits are in regulation with 2.1V of supply. The amplifiers will continue to function with as little as 1.6V, although the input common mode range and the phase margin are about gone. The minimum operating supply voltage is guaranteed by the PSRR tests that are done with the input common mode equal to 500mV and a minimum supply voltage of 2.5V.

The positive supply pin of the LT1492/LT1493 should be bypassed with a small capacitor (about 0.01 μ F) within an inch of the pin. When driving heavy loads and for good settling time, an additional 4.7 μ F capacitor should be used. When using split supplies, the same is true for the negative supply pin.

Power Dissipation

The LT1492/LT1493 combine high speed and large output drive in small packages. Because of the wide supply voltage range, it is possible to exceed the maximum junction temperature under certain conditions. Maximum junction temperature (T_J) is calculated from the ambient temperature (T_A) and power dissipation (P_D) as follows:

$$\text{LT1492CN8: } T_J = T_A + (P_D \cdot 130^\circ\text{C/W})$$

$$\text{LT1492CS8: } T_J = T_A + (P_D \cdot 190^\circ\text{C/W})$$

$$\text{LT1493CS: } T_J = T_A + (P_D \cdot 150^\circ\text{C/W})$$

Worst-case power dissipation occurs at the maximum supply current and when the output voltage is at 1/2 of either supply voltage (or the maximum swing if less than 1/2 supply voltage). For each amplifier $P_{D\text{MAX}}$ is:

$$P_{D\text{MAX}} = (V^+ - V^-)(I_{S\text{MAX}}) + (V^+/2)^2/R_L$$

Example: LT1493 at 70°C, $V_S = \pm 15\text{V}$, $R_L = 1\text{k}$

$$P_{D\text{MAX}} = (30\text{V})(930\mu\text{A}) + (7.5\text{V})^2/1\text{k}\Omega = 84.2\text{mW}$$

$$T_{J\text{MAX}} = 70^\circ\text{C} + (4 \cdot 84.2\text{mW})(150^\circ\text{C/W}) = 121^\circ\text{C}$$

Inputs

Typically, at room temperature, the inputs of the LT1492/LT1493 can common mode 400mV below ground (V^-) and to within 1.2V of the positive supply with the amplifier

still functional. However, the input bias current will shift as shown in the characteristic curves. For full precision performance, the common mode range should be limited between ground (V^-) and 1.5V below the positive supply.

When either of the inputs is taken below ground (V^-) by more than about 700mV, that input current will increase dramatically. The current is limited by internal 100 Ω resistors between the input pins and diodes to each supply. The output will remain low (no phase reversal) for inputs 1.3V below ground (V^-). If the output does not have to sink current, such as in a single supply system with a 1k load to ground, there is no phase reversal for inputs up to 8V below ground.

There are no clamps across the inputs of the LT1492/LT1493 and therefore each input can be forced to any voltage between the supplies. The input current will remain constant at about 50nA over most of this range. When an input gets closer than 1.5V to the positive supply, that input current will gradually decrease to zero until the input goes above the supply, then will increase due to the previously mentioned diodes. If the inverting input is held more positive than the noninverting input by 200mV or more, while at the same time the noninverting input is within 300mV to ground (V^-), then the supply current will increase by 1mA and the noninverting input current will increase to about 10 μ A. This should be kept in mind in comparator applications where the inverting input stays above ground (V^-) and the noninverting input is at or near ground (V^-).

Output

The output of the LT1492/LT1493 will swing to within 0.65V of the positive supply and to within 3mV of the negative supply with no load. Under loaded conditions see the Typical Performance curves for the output saturation voltage characteristics.

The output of the LT1492/LT1493 has reverse-biased diodes to each supply. If the output is forced beyond either supply, unlimited currents will flow. If the current is transient and limited to several hundred milliamps, no damage will occur.

APPLICATIONS INFORMATION

Feedback Components

Because the input currents of the LT1492/LT1493 are less than 100nA, it is possible to use high value feedback resistors to set the gain. However, care must be taken to insure that the pole that is formed by the feedback resistors and the input capacitance does not degrade the stability of the amplifier. For example, if a single supply, noninverting gain of 2 is set with two 62k resistors, the LT1492/LT1493 will probably oscillate. This is because the amplifier goes open-loop at 1MHz (6dB of gain) and has 50° of phase margin. The feedback resistors and the 10pF input capacitance generate a pole at 500kHz that introduces 63° of phase shift at 1MHz! The solution is simple, lower the values of the resistors or add a feedback capacitor of 10pF or more.

Capacitive Loading

The LT1492/LT1493 are optimized for low voltage, single supply operation. The Maximum Capacitive Load vs Load Current typical performance curve shows the circuit performance without any load resistance. When the output is sinking current or driving heavy loads with high supplies, capacitive load handling is degraded.

Maximum Capacitive Load vs Load Current

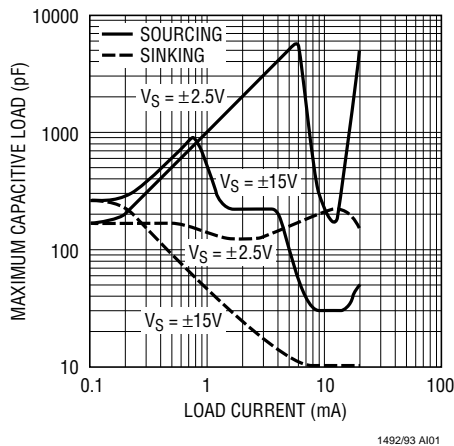

Comparator Applications

Sometimes it is desirable to use an op amp as a comparator. When operating the LT1492/LT1493 on a single 3.3V or 5V supply, the output interfaces directly with most TTL and CMOS logic.

The response time of the LT1492/LT1493 is a strong function of the amount of input overdrive as shown in the following photos. These amplifiers are unity-gain stable op amps and not fast comparators, therefore, the logic being driven may oscillate due to the long transition time. The output can be speeded up by adding 20mV or more of hysteresis (positive feedback), but the offset is then a function of the input direction.

Comparator Response (+)
20mV, 10mV, 5mV, 2mV Overdrives

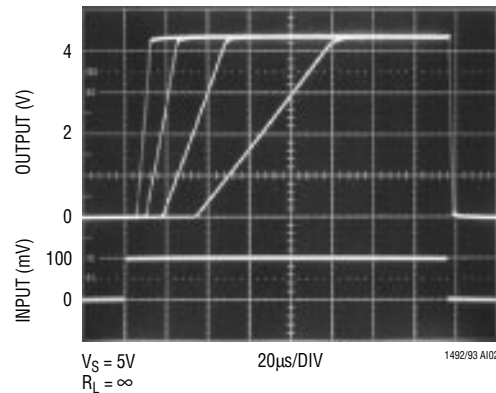

Comparator Response (-)
20mV, 10mV, 5mV, 2mV Overdrives

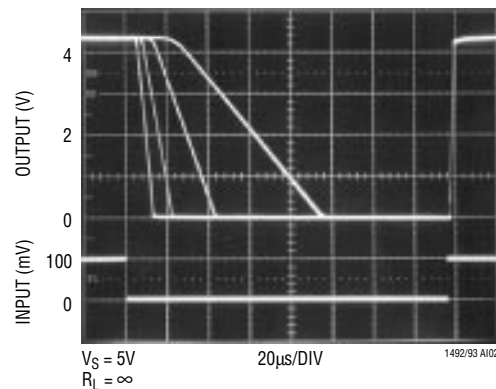

SIMPLIFIED SCHEMATIC

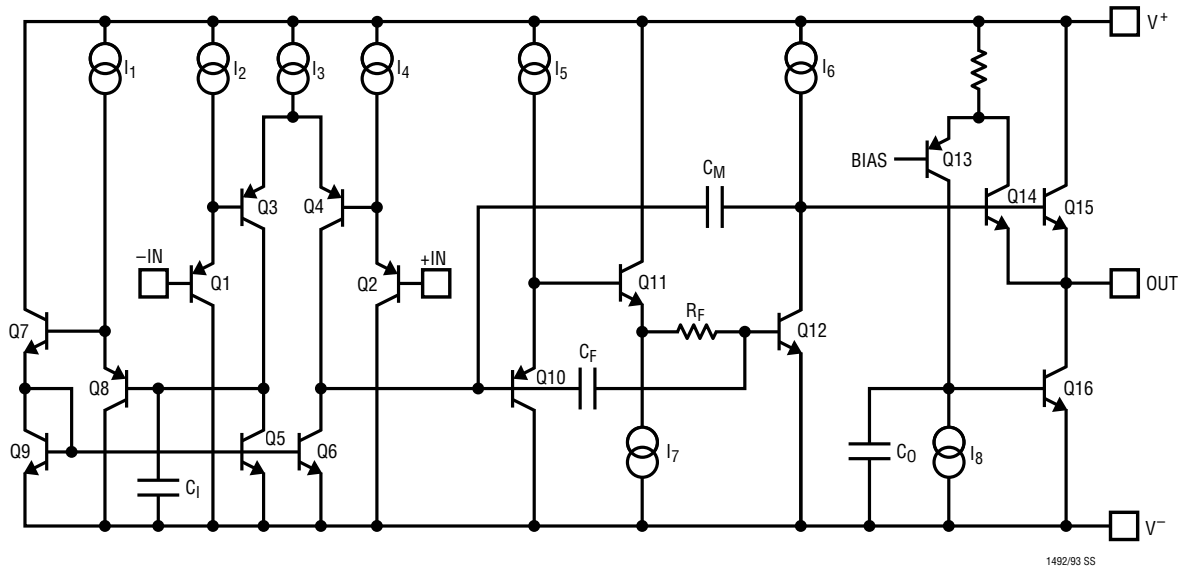

TYPICAL APPLICATIONS

1A Voltage-Controlled Current Source

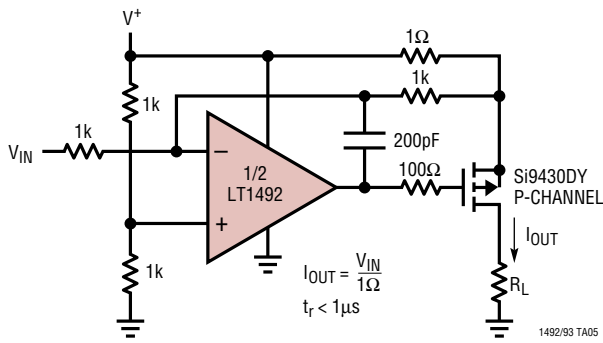

1A Voltage-Controlled Current Sink

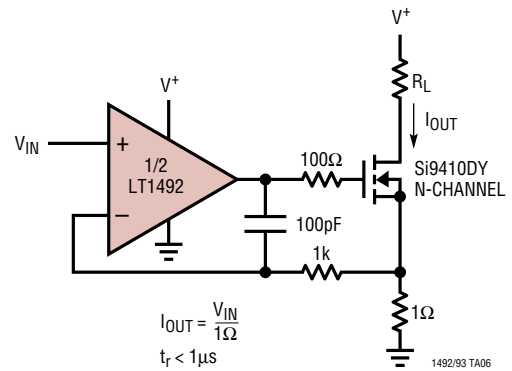

Ground Current Sense Amplifier

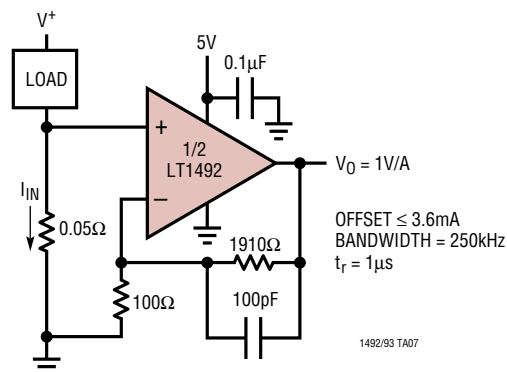

PACKAGE DESCRIPTION Dimensions in inches (millimeters) unless otherwise noted.

N8 Package
8-Lead PDIP (Narrow 0.300)
 (LTC DWG # 05-08-1510)

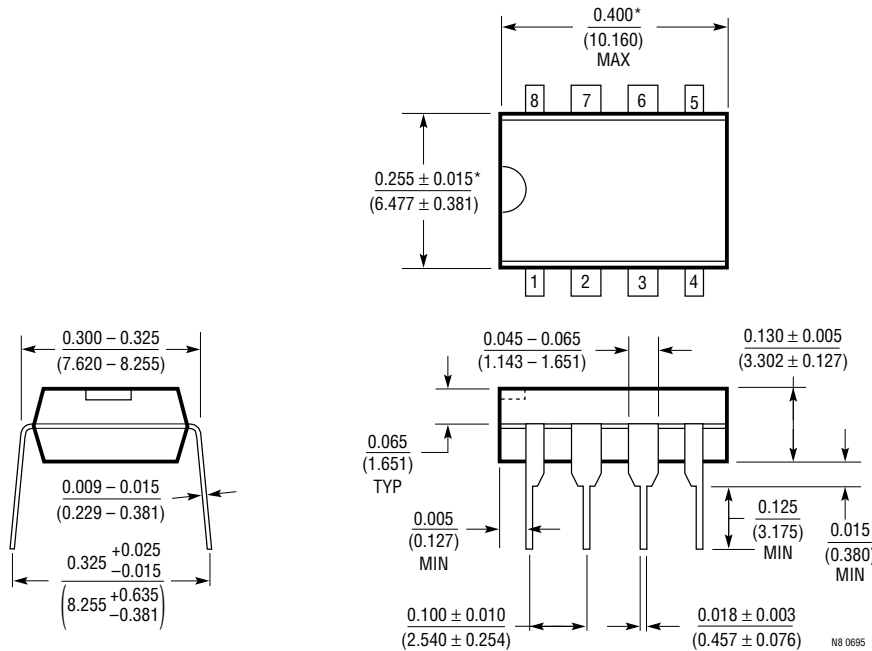

*THESE DIMENSIONS DO NOT INCLUDE MOLD FLASH OR PROTRUSIONS.
 MOLD FLASH OR PROTRUSIONS SHALL NOT EXCEED 0.010 INCH (0.254mm)

S8 Package
8-Lead Plastic Small Outline (Narrow 0.150)
 (LTC DWG # 05-08-1610)

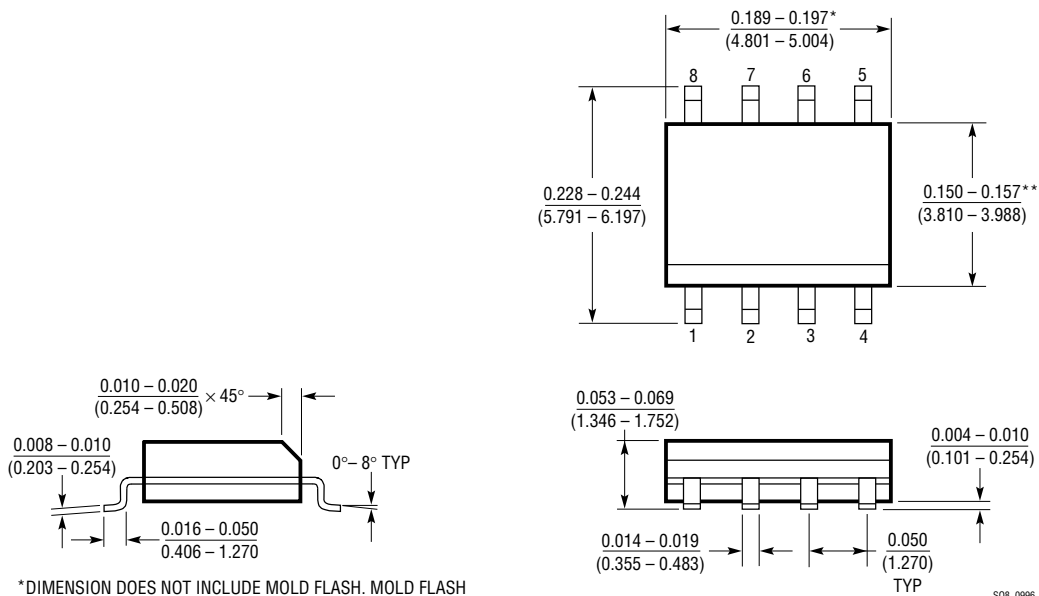

*DIMENSION DOES NOT INCLUDE MOLD FLASH. MOLD FLASH SHALL NOT EXCEED 0.006" (0.152mm) PER SIDE

**DIMENSION DOES NOT INCLUDE INTERLEAD FLASH. INTERLEAD FLASH SHALL NOT EXCEED 0.010" (0.254mm) PER SIDE

PACKAGE DESCRIPTION Dimensions in inches (millimeters) unless otherwise noted.

S Package
16-Lead Plastic Small Outline (Narrow 0.150)
 (LTC DWG # 05-08-1610)

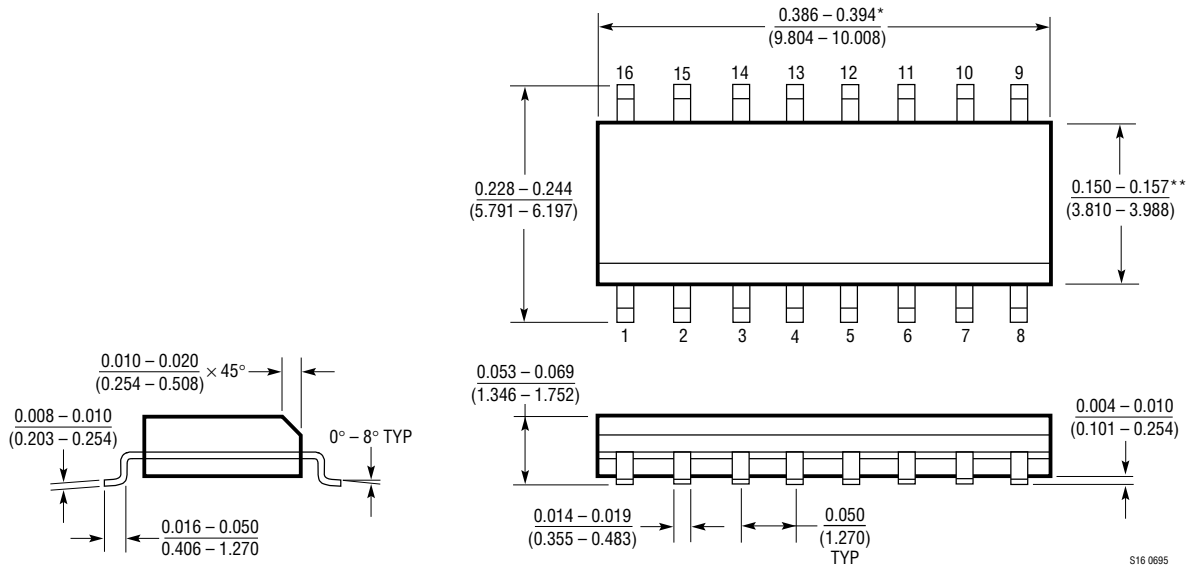

* DIMENSION DOES NOT INCLUDE MOLD FLASH. MOLD FLASH SHALL NOT EXCEED 0.006" (0.152mm) PER SIDE
 ** DIMENSION DOES NOT INCLUDE INTERLEAD FLASH. INTERLEAD FLASH SHALL NOT EXCEED 0.010" (0.254mm) PER SIDE

S16 0695

TYPICAL APPLICATION

Single Supply 100kHz 4th Order Butterworth Filter

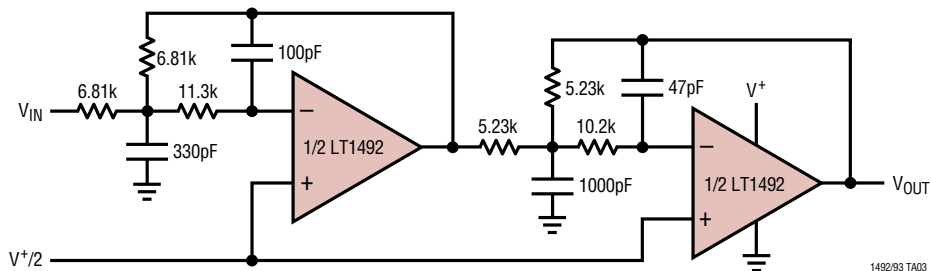

Frequency Response

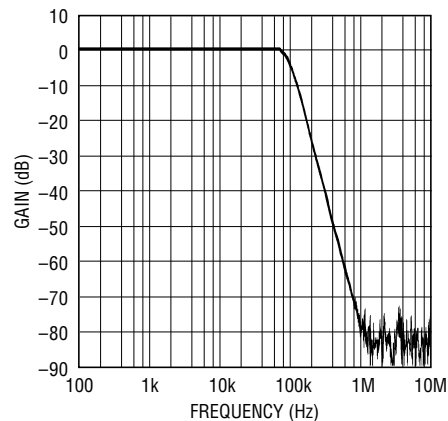

RELATED PARTS

PART NUMBER	DESCRIPTION	COMMENTS
LTC [®] 1152	Rail-to-Rail Input and Output, Zero-Drift Op Amp	High DC Accuracy, 10 μV $V_{OS(\text{MAX})}$, 100nV/ $^{\circ}\text{C}$ Drift, 1MHz GBW, 1V/ μs Slew Rate, Max Supply Current 2.2mA
LT1211/LT1212	Dual/Quad 14MHz, 7V/ μs , Single Supply Precision Op Amps	Input Common Mode Includes Ground, 275 μV $V_{OS(\text{MAX})}$, 6 $\mu\text{V}/^{\circ}\text{C}$ Max Drift, Max Supply Current 1.8mA per Amplifier
LT1213/LT1214	Dual/Quad 28MHz, 12V/ μs , Single Supply Precision Op Amps	Input Common Mode Includes Ground, 275 μV $V_{OS(\text{MAX})}$, 6 $\mu\text{V}/^{\circ}\text{C}$ Max Drift, Max Supply Current 3.5mA per Amplifier
LT1215/LT1216	Dual/Quad 23MHz, 50V/ μs , Single Supply Precision Op Amps	Input Common Mode Includes Ground, 450 μV $V_{OS(\text{MAX})}$, Max Supply Current 6.6mA per Amplifier
LT1366/LT1367	Dual/Quad Precision, Rail-to-Rail Input and Output Op Amps	475 μV $V_{OS(\text{MAX})}$, 400kHz GBW, 0.13V/ μs Slew Rate, Max Supply Current 520 μA per Amplifier
LT1490/LT1491	Dual/Quad Micropower, Rail-to-Rail Input and Output Op Amps	Max Supply Current 50 μA per Amplifier, 200kHz GBW, 0.07V/ μs Slew Rate, Operates with Inputs 44V Above V^- Independent of V^+
LT1498/LT1499	Dual/Quad Rail-to-Rail Input and Output Precision C-Load [™] Op Amps	475 μV $V_{OS(\text{MAX})}$, 10MHz GBW, 6V/ μs Slew Rate, Max Supply Current 2.2mA per Amplifier

C-Load is a trademark of Linear Technology Corporation.