

## LMC7660 Switched Capacitor Voltage Converter

### General Description

The LMC7660 is a CMOS voltage converter capable of converting a positive voltage in the range of +1.5V to +10V to the corresponding negative voltage of -1.5V to -10V. The LMC7660 is a pin-for-pin replacement for the industry-standard 7660. The converter features: operation over full temperature and voltage range without need for an external diode, low quiescent current, and high power efficiency.

The LMC7660 uses its built-in oscillator to switch 4 power MOS switches and charge two inexpensive electrolytic capacitors.

### Features

- Operation over full temperature and voltage range without an external diode
- Low supply current, 200  $\mu$ A max
- Pin-for-pin replacement for the 7660
- Wide operating range 1.5V to 10V
- 97% Voltage Conversion Efficiency
- 95% Power Conversion Efficiency
- Easy to use, only 2 external components
- Extended temperature range
- Narrow SO-8 Package

### Block Diagram

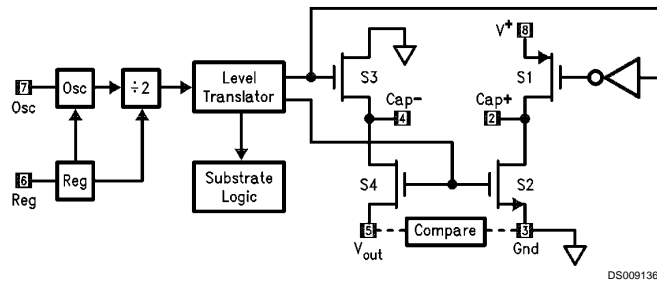

### Pin Configuration

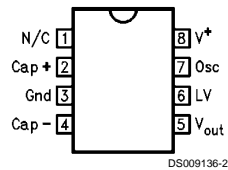

### Ordering Information

Package	Temperature Range	NSC Drawing
	Industrial -40°C to +85°C	
8-Lead Molded DIP	LMC7660IN	N08E
8-Lead Molded Small Outline	LMC7660IM	M08A

### Absolute Maximum Ratings (Note 1)

If Military/Aerospace specified devices are required, please contact the National Semiconductor Sales Office/Distributors for availability and specifications.

Supply Voltage	10.5V
Input Voltage on Pin 6, 7 (Note 2)	-0.3V to (V <sup>+</sup> + 0.3V) for V <sup>+</sup> < 5.5V (V <sup>+</sup> - 5.5V) to (V <sup>+</sup> + 0.3V) for V <sup>+</sup> > 5.5V
Current into Pin 6 (Note 2)	20 μA
Output Short Circuit Duration (V <sup>+</sup> ≤ 5.5V)	Continuous

### Power Dissipation (Note 3)

Dual-In-Line Package	1.4W
Surface-Mount Package	0.6W
T <sub>J</sub> Max (Note 3)	150°C
θ <sub>JA</sub> (Note 3)	
Dual-In-Line Package	90°C/W
Surface-Mount Package	160°C/W
Storage Temp. Range	-65°C ≤ T ≤ 150°C
Lead Temperature (Soldering, 5 sec.)	260°C
ESD Tolerance (Note 7)	± 2000V

### Electrical Characteristics (Note 4)

Symbol	Parameter	Conditions	Typ	LMC7660IN/ LMC7660IM	Units Limits
				Limit (Note 5)	
I <sub>s</sub>	Supply Current	R <sub>L</sub> = ∞	120	200 <b>400</b>	μA max
V <sup>+</sup> H	Supply Voltage Range High (Note 6)	R <sub>L</sub> = 10 kΩ, Pin 6 Open Voltage Efficiency ≥ 90%	3 to 10	3 to 10 <b>3 to 10</b>	V
V <sup>+</sup> L	Supply Voltage Range Low	R <sub>L</sub> = 10 kΩ, Pin 6 to Gnd. Voltage Efficiency ≥ 90%	1.5 to 3.5	1.5 to 3.5 <b>1.5 to 3.5</b>	V
R <sub>out</sub>	Output Source Resistance	I <sub>L</sub> = 20 mA	55	100 <b>120</b>	Ω max
		V = 2V, I <sub>L</sub> = 3 mA Pin 6 Short to Gnd.	110	200 <b>300</b>	Ω max
F <sub>osc</sub>	Oscillator Frequency		10		kHz
P <sub>eff</sub>	Power Efficiency	R <sub>L</sub> = 5 kΩ	97	95 <b>90</b>	% min
V <sub>o eff</sub>	Voltage Conversion Efficiency	R <sub>L</sub> = ∞	99.9	97 <b>95</b>	% min
I <sub>osc</sub>	Oscillator Sink or Source Current	Pin 7 = Gnd. or V <sup>+</sup>	3		μA

**Note 1:** Absolute Maximum ratings indicate limits beyond which damage to the device may occur. DC and AC electrical specifications do not apply when operating the device beyond its rated operating conditions. See Note 4 for conditions.

**Note 2:** Connecting any input terminal to voltages greater than V<sup>+</sup> or less than ground may cause destructive latchup. It is recommended that no inputs from sources operating from external supplies be applied prior to "power-up" of the LMC7660.

**Note 3:** For operation at elevated temperature, these devices must be derated based on a thermal resistance of θ<sub>JA</sub> and T<sub>J</sub> max, T<sub>J</sub> = T<sub>A</sub> + θ<sub>JA</sub> P<sub>D</sub>.

**Note 4:** Boldface numbers apply at temperature extremes. All other numbers apply at T<sub>A</sub> = 25°C, V<sup>+</sup> = 5V, C<sub>osc</sub> = 0, and apply for the LMC7660 unless otherwise specified. Test circuit is shown in Figure 1.

**Note 5:** Limits at room temperature are guaranteed and 100% production tested. Limits in **boldface** are guaranteed over the operating temperature range (but not 100% tested), and are not used to calculate outgoing quality levels.

**Note 6:** The LMC7660 can operate without an external diode over the full temperature and voltage range. The LMC7660 can also be used with the external diode Dx, when replacing previous 7660 designs.

**Note 7:** The test circuit consists of the human body model of 100 pF in series with 1500Ω.

## Electrical Characteristics (Note 4) (Continued)

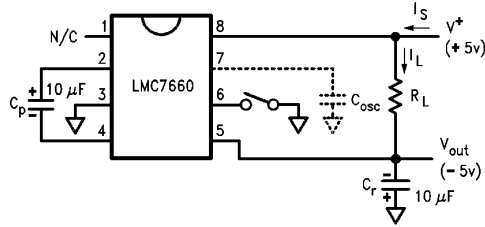

DS009136-5

FIGURE 1. LMC7660 Test Circuit

## Typical Performance Characteristics

OSC Freq. vs OSC Capacitance

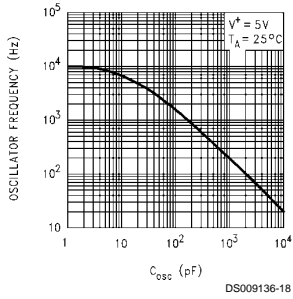

$V_{out}$  vs  $I_{out}$  @  $V^+ = 2V$

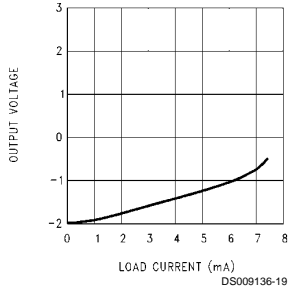

$V_{out}$  vs  $I_{out}$  @  $V^+ = 5V$

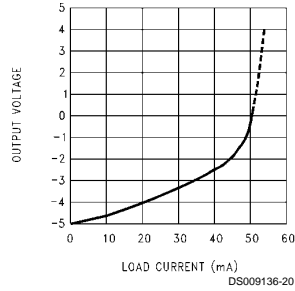

Supply Current & Power Efficiency vs Load Current ( $V^+ = 2V$ )

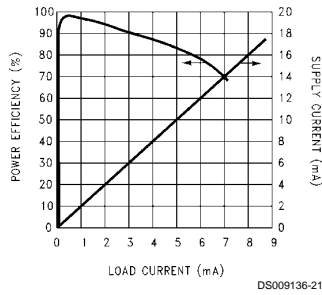

Supply Current & Power Efficiency vs Load Current ( $V^+ = 5V$ )

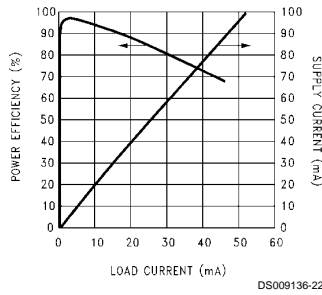

Output Source Resistance as a Function of Temperature

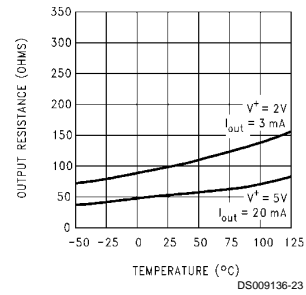

## Typical Performance Characteristics (Continued)

**Unloaded Oscillator Frequency as a Function of Temperature**

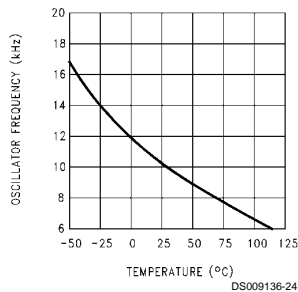

**Output R vs Supply Voltage**

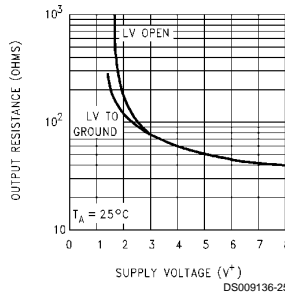

**P<sub>eff</sub> vs OSC Freq. @ V<sup>+</sup> = 5V**

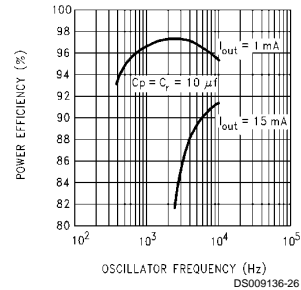

## Application Information

### Circuit Description

The LMC7660 contains four large CMOS switches which are switched in a sequence to provide supply inversion  $V_{out} = -V_{in}$ . Energy transfer and storage are provided by two inexpensive electrolytic capacitors. Figure 2 shows how the LMC7660 can be used to generate  $-V^+$  from  $V^+$ . When switches S1 and S3 are closed,  $C_p$  charges to the supply voltage  $V^+$ . During this time interval, switches S2 and S4 are open. After  $C_p$  charges to  $V^+$ , S1 and S3 are opened, S2 and S4 are then closed. By connecting S2 to ground,  $C_p$  develops a voltage  $-V^+/2$  on  $C_r$ . After a number of cycles  $C_r$  will be pumped to exactly  $-V^+$ . This transfer will be exact assuming no load on  $C_r$ , and no loss in the switches.

In the circuit of Figure 2, S1 is a P-channel device and S2, S3, and S4 are N-channel devices. Because the output is biased below ground, it is important that the  $p^-$  wells of S3 and S4 never become forward biased with respect to either their sources or drains. A substrate logic circuit guarantees that these  $p^-$  wells are always held at the proper voltage. Under all conditions S4  $p^-$  well must be at the lowest potential in the circuit. To switch off S4, a level translator generates  $V_{GS4} = 0V$ , and this is accomplished by biasing the level translator from the S4  $p^-$  well.

An internal RC oscillator and  $\div 2$  circuit provide timing signals to the level translator. The built-in regulator biases the oscillator and divider to reduce power dissipation on high supply voltage. The regulator becomes active at about  $V^+ = 6.5V$ . Low voltage operation can be improved if the LV pin is shorted to ground for  $V^+ \leq 3.5V$ . For  $V^+ \geq 3.5V$ , the LV pin must be left open to prevent damage to the part.

### Power Efficiency and Ripple

It is theoretically possible to approach 100% efficiency if the following conditions are met:

1. The drive circuitry consumes little power.
2. The power switches are matched and have low  $R_{on}$ .
3. The impedance of the reservoir and pump capacitors are negligibly small at the pumping frequency.

The LMC7660 closely approaches 1 and 2 above. By using a large pump capacitor  $C_p$ , the charge removed while supplying the reservoir capacitor is small compared to  $C_p$ 's total charge. Small removed charge means small changes in the pump capacitor voltage, and thus small energy loss and high efficiency. The energy loss by  $C_p$  is:

$$E = \frac{1}{2}C_p (V_1^2 - V_2^2)$$

By using a large reservoir capacitor, the output ripple can be reduced to an acceptable level. For example, if the load current is 5 mA and the accepted ripple is 200 mV, then the reservoir capacitor can omit approximately be calculated from:

$$I_s = C_r \frac{dv}{dt}$$

$$\sim C_r \times \frac{V_{\text{ripple p-p}}}{4/F_{\text{osc}}} \quad C_r = \frac{0.5 \text{ mA}}{0.5V/ms} = 10 \mu F$$

### Precautions

1. Do not exceed the maximum supply voltage or junction temperature.
2. Do not short pin 6 (LV terminal) to ground for supply voltages greater than 3.5V.
3. Do not short circuit the output to  $V^+$ .
4. External electrolytic capacitors  $C_r$  and  $C_p$  should have their polarities connected as shown in Figure 1.

### Replacing Previous 7660 Designs

To prevent destructive latchup, previous 7660 designs require a diode in series with the output when operated at elevated temperature or supply voltage. Although this prevented the latchup problem of these designs, it lowered the available output voltage and increased the output series resistance.

The National LMC7660 has been designed to solve the inherent latch problem. The LCM7660 can operate over the entire supply voltage and temperature range without the need for an output diode. When replacing existing designs, the LMC7660 can be operated with diode Dx.

## Application Information (Continued)

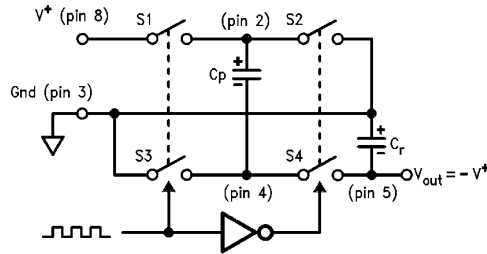

FIGURE 2. Idealized Voltage Converter

DS009136-6

## Typical Applications

### Changing Oscillator Frequency

It is possible to dramatically reduce the quiescent operating current of the LMC7660 by lowering the oscillator frequency. The oscillator frequency can be lowered from a nominal 10 kHz to several hundred hertz, by adding a slow-down capacitor  $C_{osc}$  (Figure 3). As shown in the Typical Performance Curves the supply current can be lowered to the 10  $\mu$ A range. This low current drain can be extremely useful when used in  $\mu$ Power and battery back-up equipment. It must be understood that the lower operating frequency and supply

current cause an increased impedance of  $C_r$  and  $C_p$ . The increased impedance, due to a lower switching rate, can be offset by raising  $C_r$  and  $C_p$  until ripple and load current requirements are met.

### Synchronizing to an External Clock

Figure 4 shows an LMC7660 synchronized to an external clock. The CMOS gate overrides the internal oscillator when it is necessary to switch faster or reduce power supply interference. The external clock still passes through the  $\div 2$  circuit in the 7660, so the pumping frequency will be  $\frac{1}{2}$  the external clock frequency.

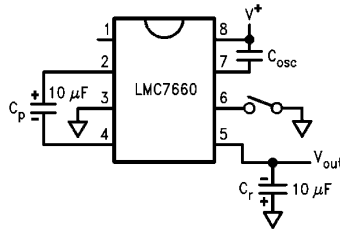

FIGURE 3. Reduce Supply Current by Lowering Oscillator Frequency

DS009136-7

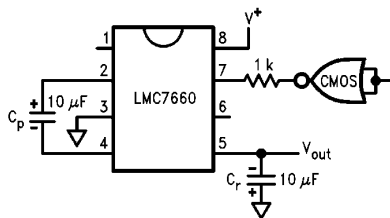

FIGURE 4. Synchronizing to an External Clock

DS009136-8

### Lowering Output Impedance

Paralleling two or more LMC7660's lowers output impedance. Each device must have its own pumping capacitor  $C_p$ , but the reservoir capacitor  $C_r$  is shared as depicted in Figure 5. The composite output resistance is:

$$R_{out} = \frac{R_{out \text{ of one LMC7660}}}{\text{Number of devices}}$$

## Typical Applications (Continued)

### Increasing Output Voltage

Stacking the LMC7660s is an easy way to produce a greater negative voltage. It should be noted that the input current required for each stage is twice the load current on that stage as shown in Figure 6. The effective output resistance is approximately the sum of the individual  $R_{out}$  values, and so only a few levels of multiplication can be used.

It is possible to generate  $-15V$  from  $+5V$  by connecting the second 7660's pin 8 to  $+5V$  instead of ground as shown in Figure 7. Note that the second 7660 sees a full  $20V$  and the input supply should not be increased beyond  $+5V$ .

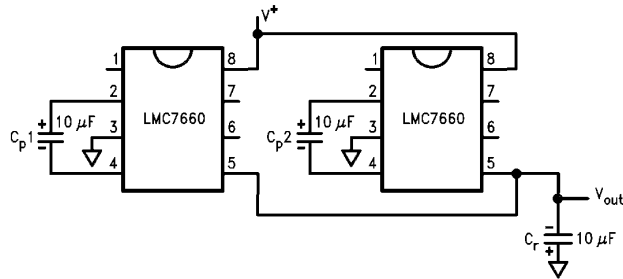

DS009136-9

FIGURE 5. Lowering Output Resistance by Paralleling Devices

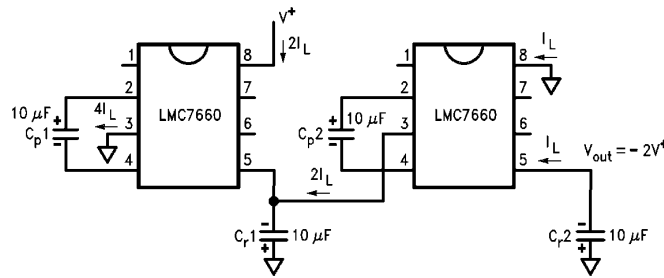

DS009136-10

FIGURE 6. Higher Voltage by Cascade

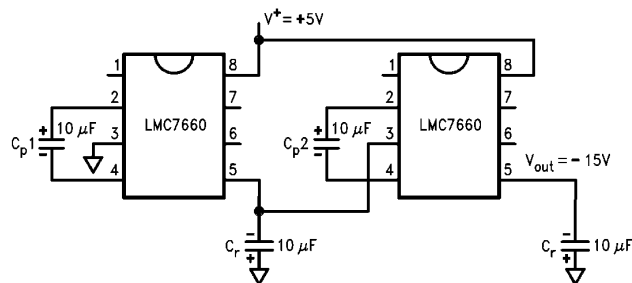

DS009136-11

FIGURE 7. Getting  $-15V$  from  $+5V$

### Split $V^+$ In Half

Figure 8 is one of the more interesting applications for the LMC7660. The circuit can be used as a precision voltage divider (for very light loads), alternately it is used to generate a  $\frac{1}{2}$  supply point in battery applications. In the  $\frac{1}{2}$  cycle when S1 and S3 are closed, the supply voltage divides across the capacitors in a conventional way proportional to their value.

In the  $\frac{1}{2}$  cycle when S2 and S4 are closed, the capacitors switch from a series connection to a parallel connection. This forces the capacitors to have the same voltage; the charge redistributes to maintain precisely  $V^+/2$ , across  $C_p$  and  $C_r$ . In this application all devices are only  $V^+/2$ , and the supply voltage can be raised to  $20V$  giving exactly  $10V$  at  $V_{out}$ .

## Typical Applications (Continued)

### Getting Up ... and Down

The LMC7660 can also be used as a positive voltage multiplier. This application, shown in *Figure 9*, requires 2 additional diodes. During the first  $\frac{1}{2}$  cycle S2 charges  $C_p1$  through D1; D2 is reverse biased. In the next  $\frac{1}{2}$  cycle S2 is open and S1 is closed. Since  $C_p1$  is charged to  $V^+ - V_{D1}$  and is referenced to  $V^+$  through S1, the junction of D1 and D2 is

at  $V^+ + (V^+ - V_{D1})$ . D1 is reverse biased in this interval. This application uses only two of the four switches in the 7660. The other two switches can be put to use in performing a negative conversion at the same time as shown in *Figure 10*. In the  $\frac{1}{2}$  cycle that D1 is charging  $C_p1$ ,  $C_p2$  is connected from ground to  $-V_{out}$  via S2 and S4, and  $C_p2$  is storing  $C_p2$ 's charge. In the interval that S1 and S3 are closed,  $C_p1$  pumps the junction of D1 and D2 above  $V^+$ , while  $C_p2$  is refreshed from  $V^+$ .

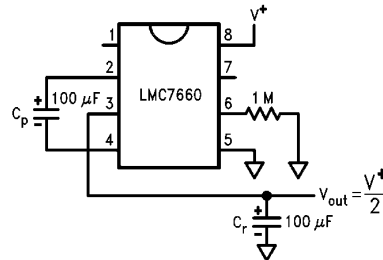

FIGURE 8. Split  $V^+$  in Half

DS009136-12

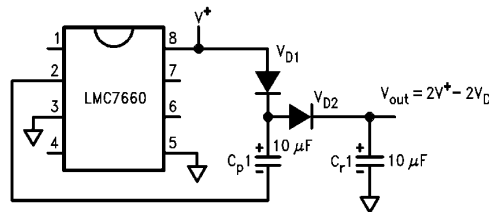

FIGURE 9. Positive Voltage Multiplier

DS009136-13

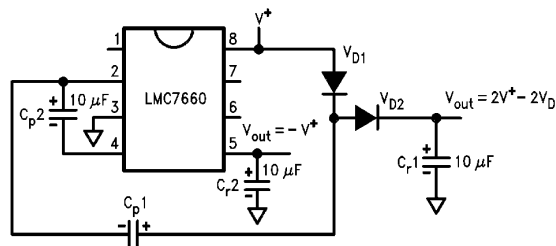

FIGURE 10. Combined Negative Converter and Positive Multiplier

DS009136-14

### Thermometer Spans 180°C

Using the combined negative and positive multiplier of *Figure 11* with an LM35 it is possible to make a  $\mu$ Power thermometer that spans a 180°C temperature range. The LM35 temperature sensor has an output sensitivity of 10 mV/°C, while drawing only 50  $\mu$ A of quiescent current. In order for the LM35 to measure negative temperatures, a pull down to a negative voltage is required. *Figure 11* shows a thermometer circuit for measuring temperatures from  $-55^\circ\text{C}$  to  $+125^\circ\text{C}$  and requiring only two 1.5V cells. End of battery life can be extended by replacing the up converter diodes with Schottky's.

### Regulating $-V_{out}$

It is possible to regulate the output of the LMC7660 and still maintain  $\mu$ Power performance. This is done by enclosing the LMC7660 in a loop with a LP2951. The circuit of *Figure 12* will regulate  $V_{out}$  to  $-5\text{V}$  for  $I_L = 10\text{ mA}$ , and  $V_{in} = 6\text{V}$ . For  $V_{in} > 7\text{V}$ , the output stays in regulation up to  $I_L = 25\text{ mA}$ . The error flag on pin 5 of the LP2951 sets low when the regulated output at pin 4 drops by about 5%. The LP2951 can be shutdown by taking pin 3 high; the LMC7660 can be shutdown by shorting pin 7 and pin 8.

## Typical Applications (Continued)

The LP2951 can be reconfigured to an adjustable type regulator, which means the LMC7660 can give a regulated output from  $-2.0V$  to  $-10V$  dependent on the resistor ratios  $R1$  and  $R2$ , as shown in *Figure 13*,  $V_{ref} = 1.235V$ :

$$V_{out} = V_{ref} \left( 1 + \frac{R1}{R2} \right)$$

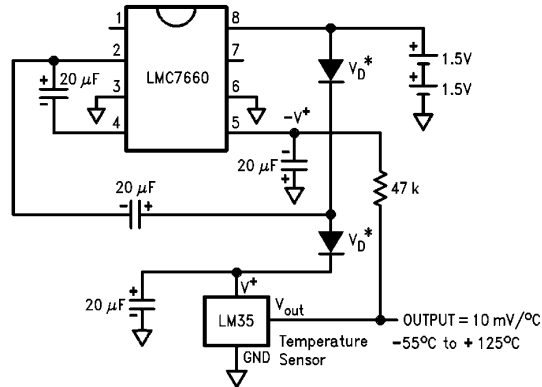

\*For lower voltage operation, use Schottky rectifiers

DS009136-15

**FIGURE 11.  $\mu$ Power Thermometer Spans  $180^\circ C$ , and Pulls Only  $150 \mu A$**

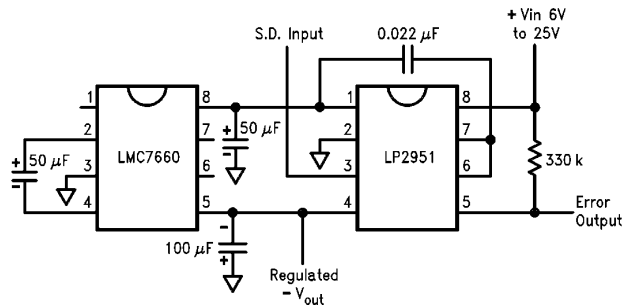
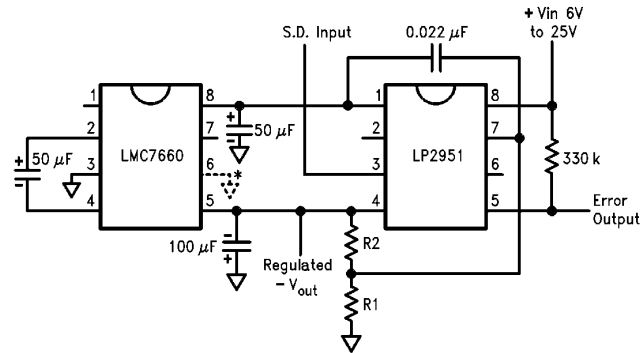

**FIGURE 12. Regulated  $-5V$  with  $200 \mu A$  Standby Current**

DS009136-16



## Typical Applications (Continued)



DS009136-17

$$V_{out} = V_{ref} \left( 1 + \frac{R1}{R2} \right)$$

$V_{ref} = 1.235V$

\*Low voltage operation

FIGURE 13. LMC7660 and LP2951 Make a Negative Adjustable Regulator



**Physical Dimensions** inches (millimeters)

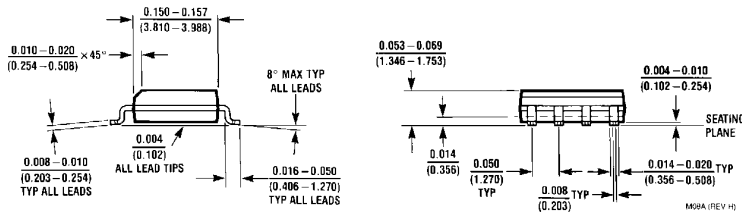
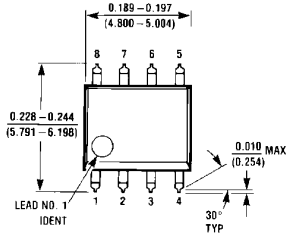

**Molded Small Outline Package (M)**  
**Order Number LMC7660IM**  
**NS Package Number M08A**

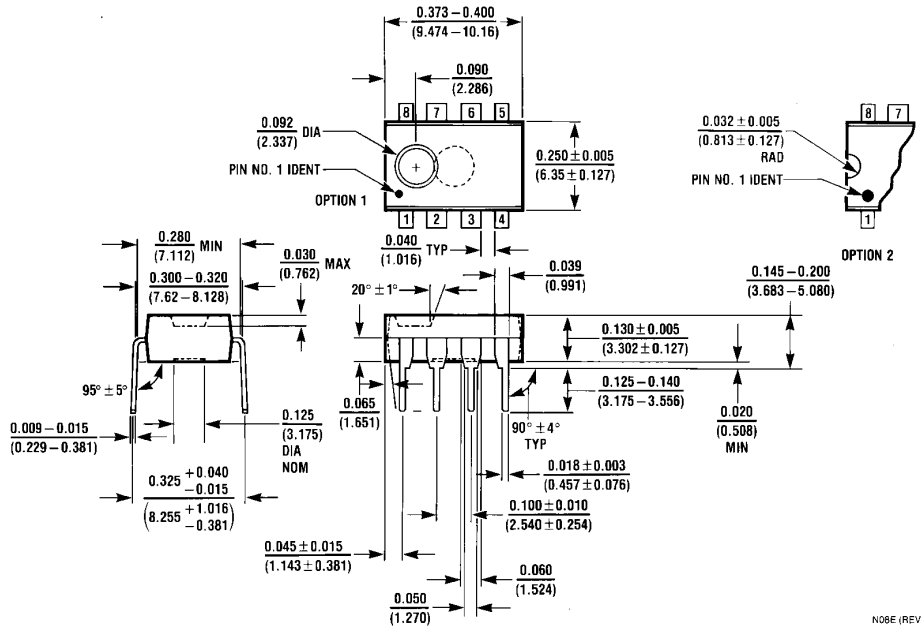

**Molded Dual-In-Line Package (N)**  
**Order Number LMC7660IN**  
**NS Package Number N08E**

**LIFE SUPPORT POLICY**

NATIONAL'S PRODUCTS ARE NOT AUTHORIZED FOR USE AS CRITICAL COMPONENTS IN LIFE SUPPORT DEVICES OR SYSTEMS WITHOUT THE EXPRESS WRITTEN APPROVAL OF THE PRESIDENT OF NATIONAL SEMICONDUCTOR CORPORATION. As used herein:

1. Life support devices or systems are devices or systems which, (a) are intended for surgical implant into the body, or (b) support or sustain life, and whose failure to perform when properly used in accordance with instructions for use provided in the labeling, can be reasonably expected to result in a significant injury to the user.
2. A critical component in any component of a life support device or system whose failure to perform can be reasonably expected to cause the failure of the life support device or system, or to affect its safety or effectiveness.



**National Semiconductor Corporation**  
1111 West Bardin Road  
Arlington, TX 76017  
Tel: 1(800) 272-9959  
Fax: 1(800) 737-7018

[www.national.com](http://www.national.com)

**National Semiconductor Europe**

Fax: (+49) 0-180-530 85 86  
Email: [cnjwge@tevm2.nsc.com](mailto:cnjwge@tevm2.nsc.com)  
Deutsch Tel: (+49) 0-180-530 85 85  
English Tel: (+49) 0-180-532 78 32  
Français Tel: (+49) 0-180-532 93 58  
Italiano Tel: (+49) 0-180-534 16 80

**National Semiconductor Hong Kong Ltd.**

13th Floor, Straight Block,  
Ocean Centre, 5 Canton Rd.  
Tsimshatsui, Kowloon  
Hong Kong  
Tel: (852) 2737-1600  
Fax: (852) 2736-9960

**National Semiconductor Japan Ltd.**

Tel: 81-043-299-2308  
Fax: 81-043-299-2408