

## LMC7211

### Tiny CMOS Comparator with Rail-to-Rail Input and Push-Pull Output

#### General Description

The LMC7211 is a micropower CMOS comparator available in the space saving SOT23-5 package. This makes the comparator ideal for space and weight critical designs. The LMC7211 is supplied in two offset voltage grades, 5 mV and 15 mV.

The main benefits of the Tiny package are most apparent in small portable electronic devices, such as mobile phones, pagers, notebook computers, personal digital assistants, and PCMCIA cards. The rail-to-rail input voltage makes the LMC7211 a good choice for sensor interfacing, such as light detector circuits, optical and magnetic sensors, and alarm and status circuits.

The Tiny Comparator's outside dimensions (length x width x height) of 3.05mm x 3.00mm x 1.43mm allow it to fit into tight spaces on PC boards.

#### Features

- Tiny SOT 23-5 package saves space
- Package is less than 1.43 mm thick
- Guaranteed specs at 2.7V, 5V, 15V supplies
- Typical supply current 7  $\mu$ A at 5V
- Response time of 4  $\mu$ s at 5V
- LMC7211 — push-pull output
- Input common-mode range beyond  $V^-$  and  $V^+$
- Low input current

#### Applications

- Battery Powered Products
- Notebooks and PDAs
- PCMCIA cards
- Mobile Communications
- Alarm and Security circuits
- Direct Sensor Interface
- Replaces amplifiers used as comparators with better performance and lower current

#### Connection Diagrams

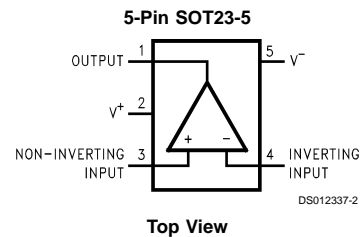
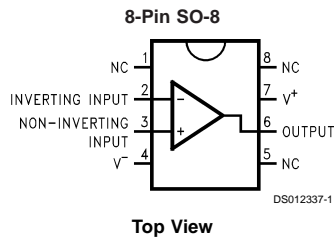

Package	Ordering Information	NSC Drawing Number	Package Marking	Transport Media
8-Pin SO-8	LMC7211AIM	M08A	LM7211AIM	Rails
	LMC7211AIMX	M08A	LM7211AIM	2.5k Units Tape and Reel
	LMC7211BIM	M08A	LM7211BIM	Rails
	LMC7211BIMX	M08A	LM7211BIM	2.5k Units tape and Reel
5-Pin SOT 23-5	LMC7211AIM5	MA05A	C00A	1k Units Tape and Reel
	LMC7211AIM5X	MA05A	C00A	3k Units Tape and Reel
	LMC7211BIM5	MA05A	C00B	1k Units Tape and Reel
	LMC7211BIM5X	MA05A	C00B	3k Units Tape and Reel

## Absolute Maximum Ratings (Note 1)

If Military/Aerospace specified devices are required, please contact the National Semiconductor Sales Office/Distributors for availability and specifications.

ESD Tolerance (Note 2)	2 kV
Differential Input Voltage	$(V_{CC}) + 0.3V$ to $(-V_{CC}) - 0.3V$
Voltage at Input/Output Pin	$(V_{CC}) + 0.3V$ to $(-V_{CC}) - 0.3V$
Supply Voltage ( $V^+ - V^-$ )	16V
Current at Input Pin (Note 7)	$\pm 5$ mA
Current at Output Pin (Notes 3, 8)	$\pm 30$ mA
Current at Power Supply Pin	40 mA
Lead Temperature (soldering, 10 sec)	260°C

Storage Temperature Range	-65°C to +150°C
Junction Temperature (Note 4)	150°C

## Operating Ratings (Note 1)

Supply Voltage	$2.7 \leq V_{CC} \leq 15V$
Junction Temperature Range LMC7211AI, LMC7211BI	$-40^\circ C \leq T_J \leq +85^\circ C$
Thermal Resistance ( $\theta_{JA}$ ) SO-8 Package, 8-Pin Surface Mount	180°C/W
M05A Package, 5-Pin Surface Mount	325°C/W

## 2.7V Electrical Characteristics

Unless otherwise specified, all limits guaranteed for  $T_J = 25^\circ C$ ,  $V^+ = 2.7V$ ,  $V^- = 0V$ ,  $V_{CM} = V_O = V^+/2$ . **Boldface** limits apply at the temperature extremes.

Symbol	Parameter	Conditions	Typ (Note 5)	LMC7211AI Limit (Note 6)	LMC7211BI Limit (Note 6)	Units
$V_{OS}$	Input Offset Voltage		3	5	15	mV
				<b>8</b>	<b>18</b>	max
$TCV_{OS}$	Input Offset Voltage Temperature Drift		1.0			$\mu V/^\circ C$
						$\mu V/\text{Month}$
	Input Offset Voltage Average Drift	(Note 10)	3.3			$\mu V/\text{Month}$
$I_B$	Input Current		0.04			pA
$I_{OS}$	Input Offset Current		0.02			pA
CMRR	Common Mode Rejection Ratio	$0V \leq V_{CM} \leq 2.7V$	75			dB
PSRR	Power Supply Rejection Ratio	$2.7V \leq V^+ \leq 15V$	80			dB
$A_V$	Voltage Gain		100			dB
CMVR	Input Common-Mode Voltage Range	CMRR > 55 dB	3.0	2.9	2.9	V
				<b>2.7</b>	<b>2.7</b>	min
			-0.3	-0.2	-0.2	V
				<b>0.0</b>	<b>0.0</b>	max
$V_{OH}$	Output Voltage High	$I_{load} = 2.5$ mA	2.5	2.4	2.4	V
				<b>2.3</b>	<b>2.3</b>	min
$V_{OL}$	Output Voltage Low	$I_{load} = 2.5$ mA	0.2	0.3	0.3	V
				<b>0.4</b>	<b>0.4</b>	max
$I_S$	Supply Current	$V_{OUT} = \text{Low}$	7	12	12	$\mu A$
				<b>14</b>	<b>14</b>	max

## 5.0V and 15.0V Electrical Characteristics

Unless otherwise specified, all limits guaranteed for  $T_J = 25^\circ C$ ,  $V^+ = 5.0V$  and  $15V$ ,  $V^- = 0V$ ,  $V_{CM} = V_O = V^+/2$ . **Boldface** limits apply at the temperature extremes.

Symbol	Parameter	Conditions	Typ (Note 5)	LMC7211AI Limit (Note 6)	LMC7211BI Limit (Note 6)	Units
$V_{OS}$	Input Offset Voltage		3	5	15	mV
				<b>8</b>	<b>18</b>	max

## 5.0V and 15.0V Electrical Characteristics (Continued)

Unless otherwise specified, all limits guaranteed for  $T_J = 25^\circ\text{C}$ ,  $V^+ = 5.0\text{V}$  and  $15\text{V}$ ,  $V^- = 0\text{V}$ ,  $V_{\text{CM}} = V_O = V^+/2$ . **Boldface** limits apply at the temperature extremes.

Symbol	Parameter	Conditions	Typ (Note 5)	LMC7211AI Limit (Note 6)	LMC7211BI Limit (Note 6)	Units
TCV <sub>OS</sub>	Input Offset Voltage Temperature Drift	V <sup>+</sup> = 5V	1.0			μV/°C
		V <sup>+</sup> = 15V	4.0			
	Input Offset Voltage Average Drift	V <sup>+</sup> = 5V	3.3			μV/Month
		V <sup>+</sup> = 15V	4.0			
I <sub>B</sub>	Input Current		0.04			pA
I <sub>OS</sub>	Input Offset Current		0.02			pA
CMRR	Common Mode Rejection Ration	V <sup>+</sup> = 5.0V	75			dB
		V <sup>+</sup> = 15.0V	82			dB
PSRR	Power Supply Rejection Ratio	5V ≤ V <sup>+</sup> ≤ 10V	80			dB
A <sub>V</sub>	Voltage Gain		100			dB
CMVR	Input Common-Mode Voltage Range	V <sup>+</sup> = 5.0V CMRR > 55 dB	5.3	5.2 <b>5.0</b>	5.2 <b>5.0</b>	V min
		V <sup>+</sup> = 5.0V CMRR > 55 dB	-0.3	-0.2 <b>0.0</b>	-0.2 <b>0.0</b>	V max
		V <sup>+</sup> = 15.0V CMRR > 55 dB	15.3	15.2 <b>15.0</b>	15.2 <b>15.0</b>	V min
		V <sup>+</sup> = 15.0V CMRR > 55 dB	-0.3	-0.2 <b>0.0</b>	-0.2 <b>0.0</b>	V max
V <sub>OH</sub>	Output Voltage High	V <sup>+</sup> = 5V I <sub>load</sub> = 5 mA	4.8	4.6 <b>4.45</b>	4.6 <b>4.45</b>	mV min
		V <sup>+</sup> = 15V I <sub>load</sub> = 5 mA	14.8	14.6 <b>14.45</b>	14.6 <b>14.45</b>	mV min
V <sub>OL</sub>	Output Voltage Low	V <sup>+</sup> = 5V I <sub>load</sub> = 5 mA	0.2	0.40 <b>0.55</b>	0.40 <b>0.55</b>	mV max
		V <sup>+</sup> = 15V I <sub>load</sub> = 5 mA	0.2	0.40 <b>0.55</b>	0.40 <b>0.55</b>	mV max
I <sub>S</sub>	Supply Current	V <sub>OUT</sub> = Low	7	14 <b>18</b>	14 <b>18</b>	μA max
I <sub>SC</sub>	Short Circuit Current	Sourcing	30			mA
		Sinking (Note 8)	45			mA

## AC Electrical Characteristics

Unless otherwise specified, all limits guaranteed for  $T_J = 25^\circ\text{C}$ ,  $V^+ = 5\text{V}$ ,  $V^- = 0\text{V}$ ,  $V_{\text{CM}} = V_O = V^+/2$ . **Boldface** limits apply at the temperature extreme.

Symbol	Parameter	Conditions	Typ (Note 5)	LMC7211AI Limit (Note 6)	LMC7211BI Limit (Note 6)	Units
t <sub>rise</sub>	Rise Time	f = 10 kHz, C <sub>I</sub> = 50 pF, Overdrive = 10 mV (Note 9)	0.3			μs
t <sub>fall</sub>	Fall Time	f = 10 kHz, C <sub>I</sub> = 50 pF, Overdrive = 10 mV (Note 9)	0.3			μs

## AC Electrical Characteristics (Continued)

Unless otherwise specified, all limits guaranteed for  $T_J = 25^\circ\text{C}$ ,  $V^+ = 5\text{V}$ ,  $V^- = 0\text{V}$ ,  $V_{\text{CM}} = V_O = V^+/2$ . **Boldface** limits apply at the temperature extreme.

Symbol	Parameter	Conditions	Typ (Note 5)	LMC7211AI Limit (Note 6)	LMC7211BI Limit (Note 6)	Units
$t_{\text{PHL}}$	Propagation Delay (High to Low) (Note 11)	$f = 10\text{ kHz}$ , $C_I = 50\text{ pF}$ (Note 9)	10 mV	10		$\mu\text{s}$
			100 mV	4		
		$V^+ = 2.7\text{V}$ , $f = 10\text{ kHz}$ , $C_I = 50\text{ pF}$ (Note 9)	10 mV	10		$\mu\text{s}$
			100 mV	4		
$t_{\text{PLH}}$	Propagation Delay (Low to High) (Note 11)	$f = 10\text{ kHz}$ , $C_I = 50\text{ pF}$ (Note 9)	10 mV	6		$\mu\text{s}$
			100 mV	4		
		$V^+ = 2.7\text{V}$ , $f = 10\text{ kHz}$ , $C_I = 50\text{ pF}$ (Note 9)	10 mV	7		$\mu\text{s}$
			100 mV	4		

**Note 1:** Absolute Maximum Ratings indicate limits beyond which damage to the device may occur. Operating Ratings indicate conditions for which the device is intended to be functional, but specific performance is not guaranteed. For guaranteed specifications and the test conditions, see the Electrical Characteristics.

**Note 2:** Human body model, 1.5 k $\Omega$  in series with 100 pF.

**Note 3:** Applies to both single-supply and split-supply operation. Continuous short circuit operation at elevated ambient temperature can result in exceeding the maximum allowed junction temperature of 150°C. Output currents in excess of  $\pm 30\text{ mA}$  over long term may adversely affect reliability.

**Note 4:** The maximum power dissipation is a function of  $T_{\text{J(max)}}$ ,  $\theta_{\text{JA}}$ , and  $T_{\text{A}}$ . The maximum allowable power dissipation at any ambient temperature is  $P_{\text{D}} = (T_{\text{J(max)}} - T_{\text{A}})/\theta_{\text{JA}}$ . All numbers apply for packages soldered directly into a PC board.

**Note 5:** Typical values represent the most likely parametric norm.

**Note 6:** All limits are guaranteed by testing or statistical analysis.

**Note 7:** Limiting input pin current is only necessary for input voltages that exceed absolute maximum input voltage rating.

**Note 8:** Do not short circuit output to  $V^+$ , when  $V^+$  is greater than 12V or reliability will be adversely affected.

**Note 9:**  $C_L$  includes the probe and jig capacitance.

**Note 10:** Input offset voltage average drift is calculated by dividing the accelerated operating life  $V_{\text{OS}}$  drift by the equivalent operational time. This represents worst case input conditions and includes the first 30 days of drift.

**Note 11:** Input step voltage for propagation delay measurement is 2V.

## Typical Performance Characteristics Single Supply $T_{\text{A}} = 25^\circ\text{C}$ unless specified

**Supply Current vs Supply Voltage**

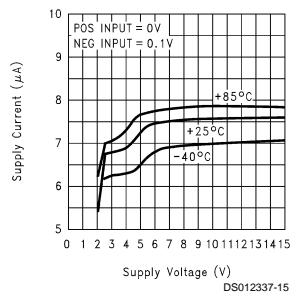

**Supply Current vs Temperature while Sourcing**

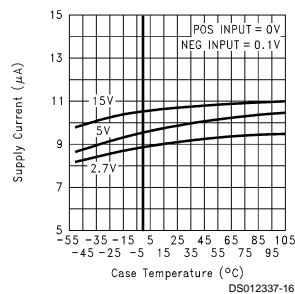

**Supply Current vs Temperature while Sinking**

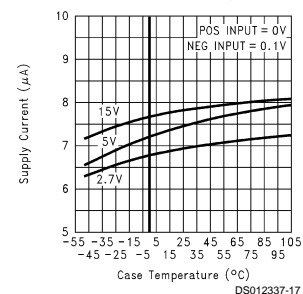

## Typical Performance Characteristics Single Supply $T_A = 25^\circ\text{C}$ unless specified (Continued)

**Output Sourcing Current vs Supply Voltage**

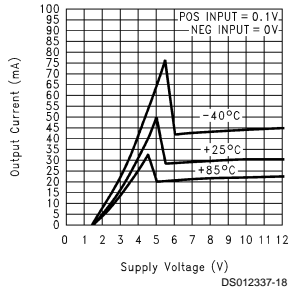

**Output Sinking Current vs Supply Voltage**

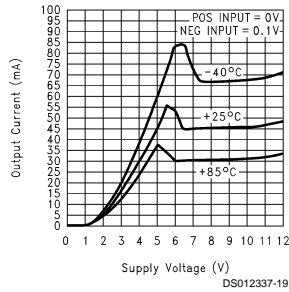

**Output Sourcing Current vs Output Voltage @ 5V**

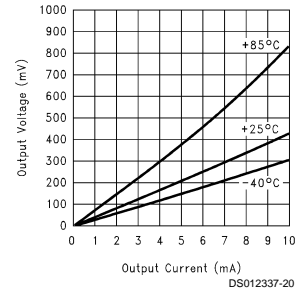

**Output Sinking Current vs Output Voltage @ 5V**

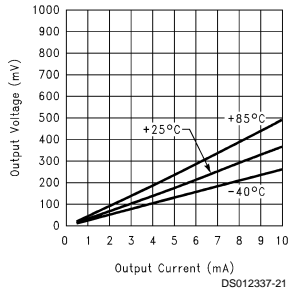

**Output Sourcing Current vs Output Voltage @ 15V**

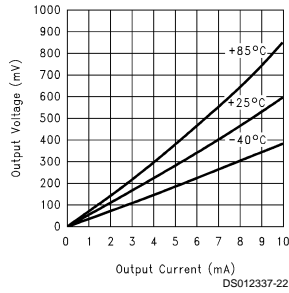

**Output Sinking Current vs Output Voltage @ 15V**

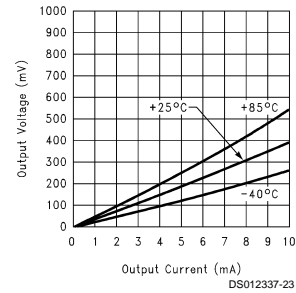

**Response Time for Various Input Overdrives  $-t_{PLH}$**

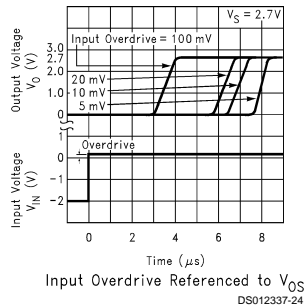

**Response Time for Various Input Overdrives  $-t_{PHL}$**

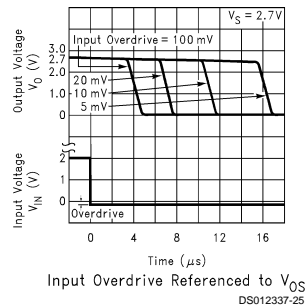

**Typical Performance Characteristics** Single Supply  $T_A = 25^\circ\text{C}$  unless specified (Continued)

**Response Time for Various Input Overdrives  $-t_{PLH}$**

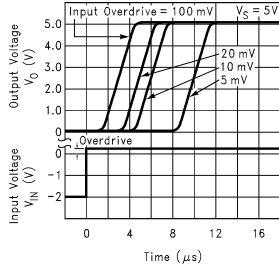

Input Overdrive Referenced to  $V_{OS}$   
DS012337-26

**Response Time for Various Input Overdrives  $-t_{PHL}$**

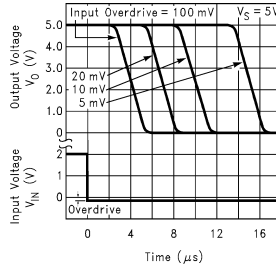

Input Overdrive Referenced to  $V_{OS}$   
DS012337-27

**Response Time for Various Input Overdrives  $-t_{PLH}$**

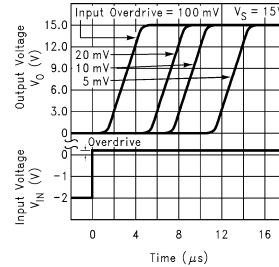

Input Overdrive Referenced to  $V_{OS}$   
DS012337-28

**Response Time for Various Input Overdrives  $-t_{PHL}$**

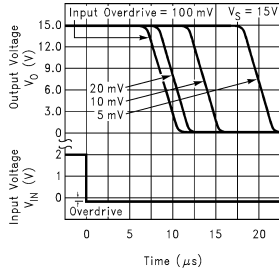

Input Overdrive Referenced to  $V_{OS}$   
DS012337-29

**Input Bias Current vs Common Mode Voltage**

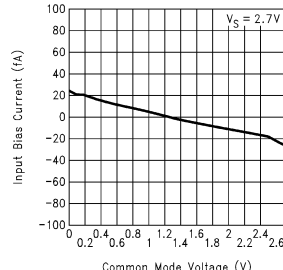

DS012337-30

**Input Bias Current vs Common Mode Voltage**

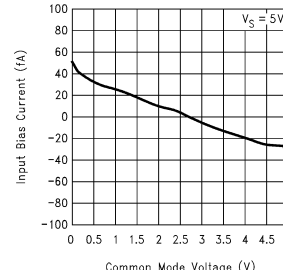

DS012337-31

**Input Bias Current vs Common Mode Voltage**

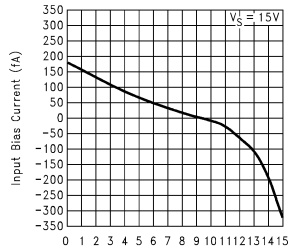

DS012337-32

**Input Bias Current vs Temperature**

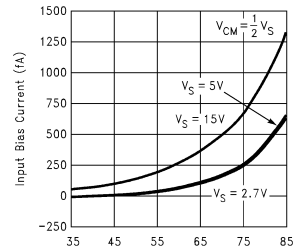

DS012337-33

## Application Information

### 1.0 Benefits of the LMC7211 Tiny Comparator

**Size.** The small footprint of the SOT 23-5 packaged Tiny Comparator, (0.120 x 0.118 inches, 3.05 x 3.00 mm) saves space on printed circuit boards, and enable the design of smaller electronic products. Because they are easier to carry, many customers prefer smaller and lighter products.

**Height.** The height (0.056 inches, 1.43 mm) of the Tiny Comparator makes it possible to use it in PCMCIA type III cards.

**Simplified Board Layout.** The Tiny Comparator can simplify board layout in several ways. First, by placing a comparator where comparators are needed, instead of routing signals to a dual or quad device, long pc traces may be avoided.

By using multiple Tiny Comparators instead of duals or quads, complex signal routing and possibly crosstalk can be reduced.

**Low Supply Current.** The typical 7  $\mu\text{A}$  supply current of the LMC7211 extends battery life in portable applications, and may allow the reduction of the size of batteries in some applications.

**Wide Voltage Range.** The LMC7211 is characterized at 15V, 5V and 2.7V. Performance data is provided at these popular voltages. This wide voltage range makes the LMC7211 a good choice for devices where the voltage may vary over the life of the batteries.

**Digital Outputs Representing Signal Level.** Comparators provide a high or low digital output depending on the voltage levels of the (+) and (-) inputs. This makes comparators useful for interfacing analog signals to microprocessors and other digital circuits. The LMC7211 can be thought of as a one-bit a/d converter.

**Push-Pull Output.** The push-pull output of the LMC7211 is capable of both sourcing and sinking milliamp level currents even at a 2.7 volt supply. This can allow the LMC7211 to drive multiple logic gates.

**Driving LEDs (Light Emitting Diodes).** With a 5 volt power supply, the LMC7211's output sinking current can drive small, high efficiency LEDs for indicator and test point circuits. The small size of the Tiny package makes it easy to find space to add this feature to even compact designs.

**Input range to Beyond Rail to Rail.** The input common mode range of the LMC7211 is slightly larger than the actual power supply range. This wide input range means that the comparator can be used to sense signals close to the power supply rails. This wide input range can make design easier by eliminating voltage dividers, amplifiers, and other front end circuits previously used to match signals to the limited input range of earlier comparators. This is useful to power supply monitoring circuits which need to sense their own power supply, and compare it to a reference voltage which is close to the power supply voltage. The wide input range can also be useful for sensing the voltage drop across a current sense resistor for battery chargers.

**Zero Crossing Detector.** Since the LMC7211's common mode input range extends below ground even when powered by a single positive supply, it can be used with large input resistors as a zero crossing detector.

**Low Input Currents and High Input Impedance.** These characteristics allow the LMC7211 to be used to sense high impedance signals from sensors. They also make it possible to use the LMC7211 in timing circuits built with large value resistors. This can reduce the power dissipation of timing cir-

cuits. For very long timing circuits, using high value resistors can reduce the size and cost of large value capacitors for the same R-C time constant.

**Direct Sensor Interfacing.** The wide input voltage range and high impedance of the LMC7211 may make it possible to directly interface to a sensor without the use of amplifiers or bias circuits. In circuits with sensors which can produce outputs in the tens to hundreds of millivolts, the LMC7211 can compare the sensor signal with an appropriately small reference voltage. This may be done close to ground or the positive supply rail. Direct sensor interfacing may eliminate the need for an amplifier for the sensor signal. Eliminating the amplifier can save cost, space, and design time.

### 2.0 Low Voltage Operation

Comparators are the common devices by which analog signals interface with digital circuits. The LMC7211 has been designed to operate at supply voltages of 2.7V without sacrificing performance to meet the demands of 3V digital systems.

At supply voltages of 2.7V, the common-mode voltage range extends 200 mV (guaranteed) below the negative supply. This feature, in addition to the comparator being able to sense signals near the positive rail, is extremely useful in low voltage applications.

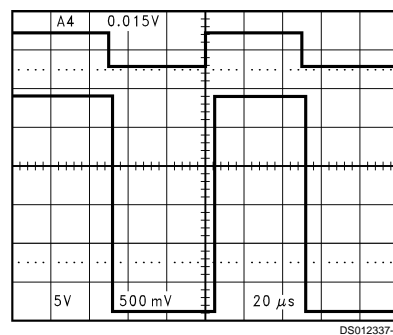

**FIGURE 1. Even at Low-Supply Voltage of 2.7V, an Input Signal which Exceeds the Supply Voltages Produces No Phase Inversion at the Output**

At  $V^+ = 2.7\text{V}$  propagation delays are  $t_{\text{PLH}} = 4 \mu\text{s}$  and  $t_{\text{PHL}} = 4 \mu\text{s}$  with overdrives of 100 mV.

Please refer to the performance curves for more extensive characterization.

### 3.0 Shoot-Through Current

The shoot-through current is defined as the current surge, above the quiescent supply current, between the positive and negative supplies of a device. The current surge occurs when the output of the device switches states. The shoot-through current results in glitches in the supply voltages. Usually, glitches in the supply lines are prevented by bypass capacitors. When the glitches are minimal, the value of the bypass capacitors can be reduced.

## Application Information (Continued)

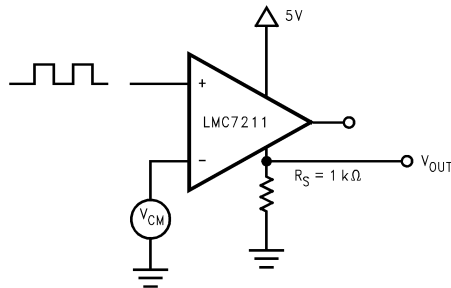

DS012337-6

**FIGURE 2. Circuit for Measurement of the Shoot-Through Current**

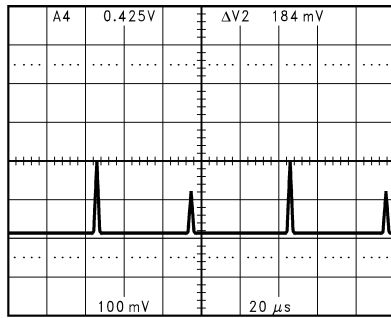

DS012337-7

**FIGURE 3. Measurement of the Shoot-Through Current**

From *Figure 3*, the shoot-through current for the LMC7211 can be calculated to be 0.2 mA (typical), and the duration is 1  $\mu$ s. The values needed for the bypass capacitors can be calculated as follows:

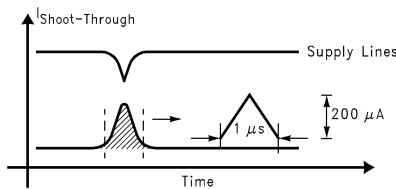

DS012337-8

$$\begin{aligned} \text{Area of } \Delta &= \frac{1}{2} (1 \mu\text{s} \times 200 \mu\text{A}) \\ &= 100 \text{ pC} \end{aligned}$$

The capacitor needs to supply 100 picocoulomb. To avoid large shifts in the comparator threshold due to changes in the voltage level, the voltage drop at the bypass capacitor should be limited to 100 mV or less.

The charge needed (100 picocoulomb) and the allowable voltage drop (100 mV) will give us the minimum capacitor value required.

$$\Delta Q = C (\Delta V)$$

$$C = \Delta Q / \Delta V = 100 \text{ picocoulomb} / 100 \text{ mV}$$

$$C = 10^{-10} / 10^{-1} = 10^{-9} = 1 \text{ nF} = 0.001 \mu\text{F}$$

$$10^{-9} = 1 \text{ nF} = 0.001 \mu\text{F}$$

The voltage drop of  $-100$  mV will cause a threshold shift in the comparator. This threshold shift will be reduced by the power supply rejection ratio, (PSRR). The PSRR which is applicable here is not the DC value of PSRR ( $-80$  dB), but a transient PSRR which will be usually about 20 dB–40 dB, depending on the circuit and the speed of the transient. This will result in an effective threshold shift of about 1 mV to 10 mV.

For precision and level sensing circuits, it is generally a good goal to reduce the voltage delta on the power supply to a value equal to or less than the hysteresis of the comparator circuit. If the above circuit was to be used with 50 mV of hysteresis, it would be reasonable to increase the bypass capacitor to 0.01  $\mu$ F to reduce the voltage delta to 10 mV. Larger values may be useful for obtaining more accurate and consistent switching.

Note that the switching current of the comparator can spread to other parts of the board as noise. The bypass capacitor reduces this noise. For low noise systems this may be reason to make the capacitor larger.

For non-precision circuits, such as using a comparator to determine if a push-button switch is on or off, it is often cheaper and easier to use a larger value of hysteresis and a small value or bypass capacitance. The low shoot-through current of the LMC7211 can allow the use of smaller and less expensive bypass capacitors in non-critical circuits.

### 4.0 Output Short Circuit Current

The LMC7211 has short circuit protection of 40 mA. However, it is not designed to withstand continuous short circuits, transient voltage or current spikes, or shorts to any voltage beyond the supplies. A resistor in series with the output should reduce the effect of shorts. For outputs which send signals off PC boards additional protection devices, such as diodes to the supply rails, and varistors may be used.

### 5.0 Hysteresis

If the input signal is very slow or very noisy, the comparator output might trip several times as the input signal passes through the threshold. Using positive feedback to add hysteresis to the switching can reduce or eliminate this problem. The positive feedback can be added by a high value resistor ( $R_F$ ). This will result in two switching thresholds, one for increasing signals and one for decreasing signals. A capacitor can be added across  $R_F$  to increase the switching speed and provide more short term hysteresis. This can result in greater noise immunity for the circuit.

See *Figure 4*, *Figure 5* and *Figure 6*.

Note that very heavy loading of the comparator output, such as LED drive or bipolar logic gates, will change the output voltage and shift the voltage thresholds.



## Application Information (Continued)

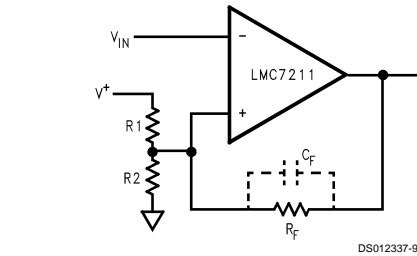

$$R_F \gg R_1 \text{ and}$$

$$R_F \gg R_2$$

FIGURE 4. Positive Feedback for Hysteresis

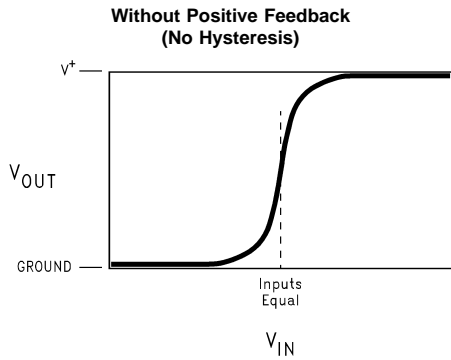

FIGURE 5.

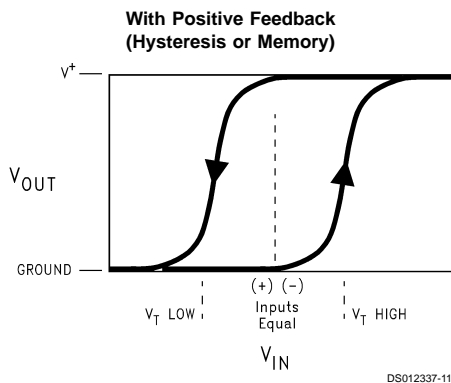

FIGURE 6.

### 6.0 Input Protection

If input signals are like to exceed the common mode range of the LMC7211, or it is likely that signals may be present when power is off, damage to the LMC7211 may occur. Large value (100 k $\Omega$  to M $\Omega$ ) input resistors may reduce the likelihood of damage by limiting the input currents. Since the LMC7211 has very low input leakage currents, the effect on accuracy will be small. Additional protection may require the use of diodes, as shown in Figure 7. Note that diode leakage

current may affect accuracy during normal operation. The R-C time constant of R<sub>IN</sub> and the diode capacitance may also slow response time.

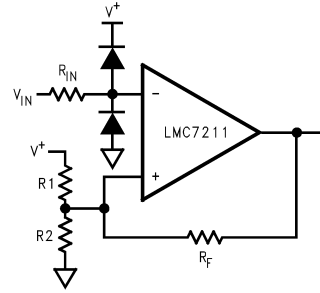

FIGURE 7.

### 7.0 Layout Considerations

The LMC7211 is not an especially fast comparator, so high speed design practices are not required. The LMC7211 is capable of operating with very high impedance inputs, so precautions should be taken to reduce noise pickup with high impedance (~ 100 k $\Omega$  and greater) designs and in electrically noisy environments.

Keeping high value resistors close to the LMC7211 and minimizing the size of the input nodes is a good practice. With multilayer designs, try to avoid long loops which could act as inductors (coils). Sensors which are not close to the comparator may need twisted pair or shielded connections to reduce noise.

### 8.0 Open Drain Output, Dual Versions

The LMC7221 is a comparator similar to the LMC7211, but with an open drain output which allows the output voltage to be different (higher or lower) than the supply voltage. The open drain output is like the open collector output of a logic gate. This makes the LMC7221 very useful for mixed voltage systems. Many systems will have different voltages for the analog and microprocessor sections. Please see the LMC7221 datasheet for details.

The performance of the LMC7211 is available in dual devices. Please see the LMC6762 datasheet for details on a dual push-pull output device. For a dual device with open drain outputs, please see the LMC6772 datasheet.

#### Rail-to-Rail Input Low Power Comparators —

##### Push-Pull Output

LMC7211	SOT23-5, SO-8	Single
LMC6762	SO-8, DIP	Dual

##### Open Drain Output

LMC7221	SOT23-5, SO-8	Single
LMC6772	SO-8, DIP	Dual

## Application Information (Continued)

### 9.0 Additional SOT23-5 Tiny Devices

National Semiconductor has additional parts available in the space saving SOT23 Tiny package, including amplifiers, voltage references, and voltage regulators. These devices include—

**LMC7101** 1 MHz gain-bandwidth rail-to-rail input and output amplifier—high input impedance and high gain 700  $\mu$ A typical current 2.7V, 3V, 5V and 15V specifications.

**LMC7111** Low power 50 kHz gain-bandwidth rail-to-rail input and output amplifier with 25  $\mu$ A typical current specified at 2.7V, 3.0V, 3.3V, 5V and 10V.

**LM7131** Tiny Video amp with 70 MHz gain bandwidth 3V, 5V and  $\pm$ 5V specifications.

**LP2980** Micropower SOT 50 mA Ultra Low-Dropout Regulator.

**LM4040** Precision micropower shunt voltage reference. Fixed voltages of 2.500V, 4.096V, 5.000V, 8.192V and 10.000V.

**LM4041** Precision micropower shut voltage reference 1.225V and adjustable.

**LM385** Low current voltage reference. Fixed Voltages of 1.2V and 2.5V.

Contact your National Semiconductor representative for the latest information.

### 10.0 Spice Macromodel

A Spice Macromodel is available for the LMC7211 comparator on the National Semiconductor Amplifier Macromodel disk. Contact your National Semiconductor representative to obtain the latest version.

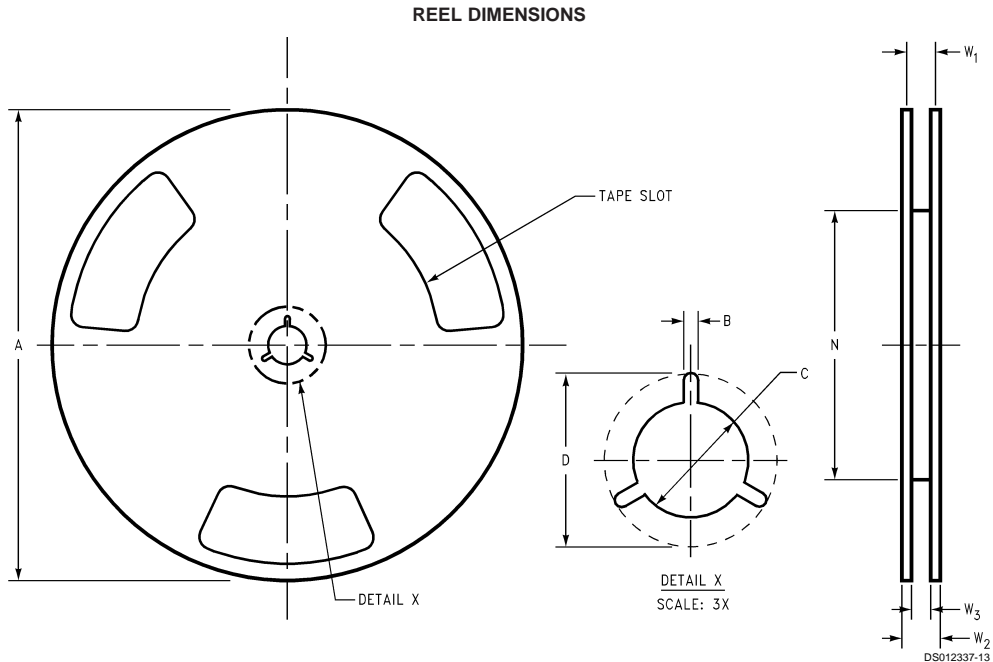

8 mm	7.00	0.059	0.512	0.795	2.165	0.331 + 0.059/-0.000	0.567	W1+ 0.078/-0.039
	330.00	1.50	13.00	20.20	55.00	8.40 + 1.50/-0.00	14.40	W1 + 2.00/-1.00
Tape Size	A	B	C	D	N	W1	W2	W3

## SOT-23-5 Tape and Reel Specification

### TAPE FORMAT

Tape Section	# Cavities	Cavity Status	Cover Tape Status
Leader	0 (min)	Empty	Sealed
(Start End)	75 (min)	Empty	Sealed

## SOT-23-5 Tape and Reel Specification (Continued)

### TAPE FORMAT (Continued)

Tape Section	# Cavities	Cavity Status	Cover Tape Status
Carrier	3000	Filled	Sealed
	1000	Filled	Sealed
Trailer (Hub End)	125 (min)	Empty	Sealed
	0 (min)	Empty	Sealed

### TAPE DIMENSIONS

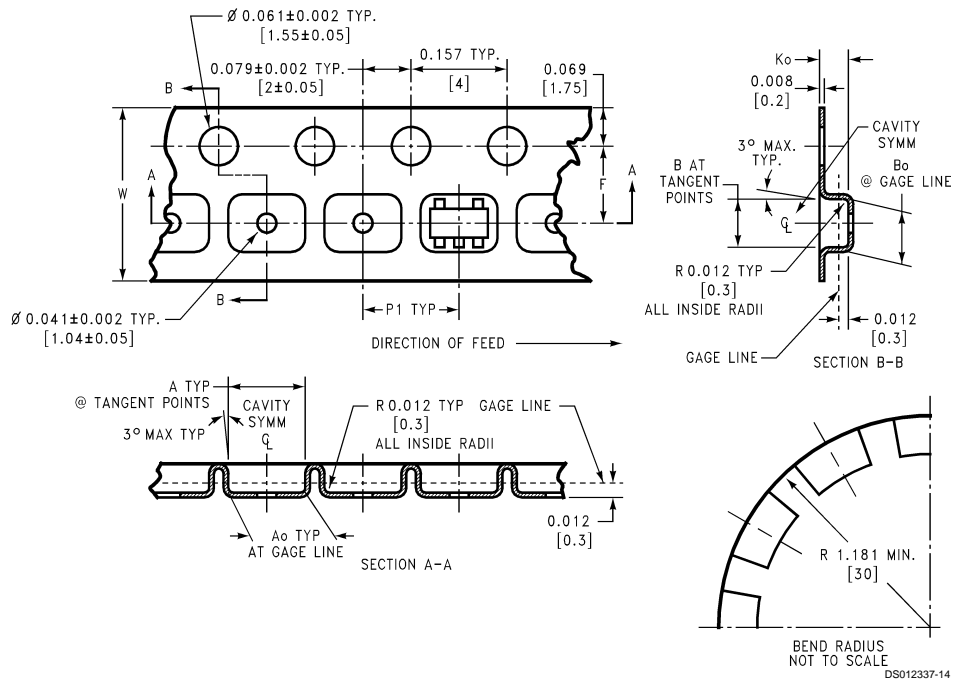

<b>8 mm</b>	<b>0.130</b>	<b>0.124</b>	<b>0.130</b>	<b>0.126</b>	<b>0.138 ± 0.002</b>	<b>0.055 ± 0.004</b>	<b>0.157</b>	<b>0.315 ± 0.012</b>
	<b>(3.3)</b>	<b>(3.15)</b>	<b>(3.3)</b>	<b>(3.2)</b>	<b>(3.5 ± 0.05)</b>	<b>(1.4 ± 0.11)</b>	<b>(4)</b>	<b>(8 ± 0.3)</b>
Tape Size	DIM A	DIM A <sub>o</sub>	DIM B	DIM B <sub>o</sub>	DIM F	DIM K <sub>o</sub>	DIM P <sub>1</sub>	DIM W

**Physical Dimensions** inches (millimeters) unless otherwise noted

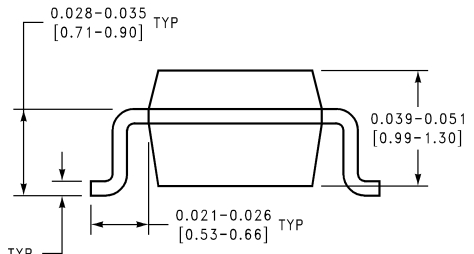
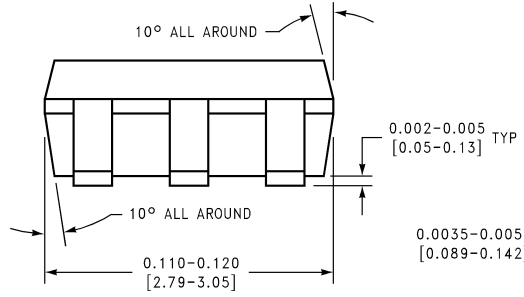
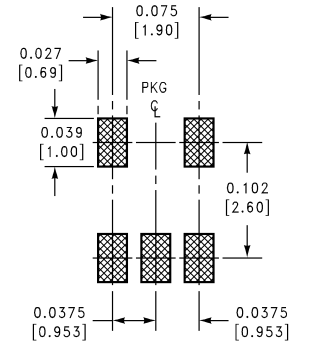
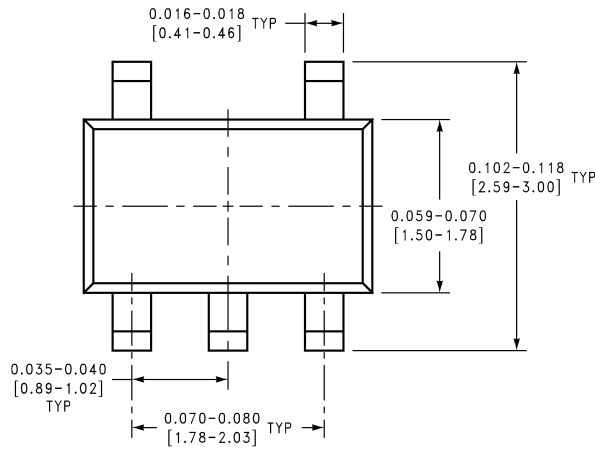

MA05A (REV D)

**5-Pin SOT Package**  
**Order Number LMC7211AIM5, LMC7211AIM5X, LMC7211BIM5 or LMC7211BIM5X**  
**NS Package Number MA05A**

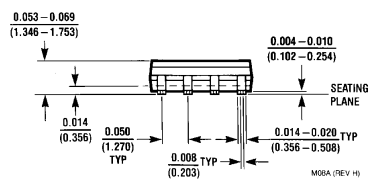
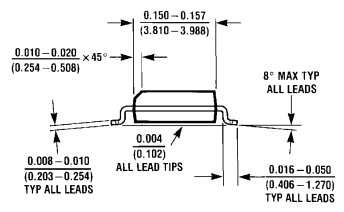
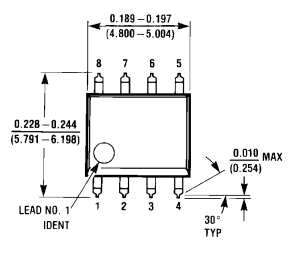

M08A (REV H)

**8-Pin Small Outline Package**  
**Order Number LMC7211AIM, LMC7211AIMX, LMC7211BIM or LMC7211BIMX**  
**NS Package Number M08A**

**Physical Dimensions** inches (millimeters) unless otherwise noted (Continued)**LIFE SUPPORT POLICY**

NATIONAL'S PRODUCTS ARE NOT AUTHORIZED FOR USE AS CRITICAL COMPONENTS IN LIFE SUPPORT DEVICES OR SYSTEMS WITHOUT THE EXPRESS WRITTEN APPROVAL OF THE PRESIDENT AND GENERAL COUNSEL OF NATIONAL SEMICONDUCTOR CORPORATION. As used herein:

1. Life support devices or systems are devices or systems which, (a) are intended for surgical implant into the body, or (b) support or sustain life, and whose failure to perform when properly used in accordance with instructions for use provided in the labeling, can be reasonably expected to result in a significant injury to the user.
2. A critical component is any component of a life support device or system whose failure to perform can be reasonably expected to cause the failure of the life support device or system, or to affect its safety or effectiveness.



**National Semiconductor Corporation**  
Americas  
Tel: 1-800-272-9959  
Fax: 1-800-737-7018  
Email: support@nsc.com

www.national.com

**National Semiconductor Europe**  
Fax: +49 (0) 1 80-530 85 86  
Email: europe.support@nsc.com  
Deutsch Tel: +49 (0) 1 80-530 85 85  
English Tel: +49 (0) 1 80-532 78 32  
Français Tel: +49 (0) 1 80-532 93 58  
Italiano Tel: +49 (0) 1 80-534 16 80

**National Semiconductor Asia Pacific Customer Response Group**  
Tel: 65-2544466  
Fax: 65-2504466  
Email: sea.support@nsc.com

**National Semiconductor Japan Ltd.**  
Tel: 81-3-5639-7560  
Fax: 81-3-5639-7507