

LM3691 High-Accuracy, Miniature 1-A Step-Down DC-DC Converter for Portable Applications

1 Features

- Input Voltage: 2.3 V to 5.5 V
- Output Voltage: 0.75 V to 3.3 V
- $\pm 1\%$ DC Output Voltage Precision
- 4-MHz Switching Frequency
- 64- μ A (typical) Quiescent Current in ECO Mode
- 1-A Maximum Load Capability
- Automatic ECO/PWM Mode Switching
- MODE Pin to Select ECO/Forced PWM Mode
- Current Overload and Thermal Shutdown Protections
- Only Three Tiny Surface-Mount External Components Required (Solution Size Less Than 15 mm²)

2 Applications

- Mobile Phones
- Hand-Held Radios
- MP3 Players
- Portable Hard Disk Drives

3 Description

The LM3691 step-down DC-DC converter is optimized for powering ultra-low-voltage circuits from a single Li-Ion cell or 3 cell NiMH/NiCd batteries. It provides up to 1-A load current over an input voltage range from 2.3 V to 5.5 V. There are several different fixed voltage output options available.

The LM3691 has a mode-control pin that allows the user to select Forced PWM mode or ECO mode that changes modes between gated PWM mode and PWM automatically, depending on the load. In ECO mode, the device offers superior efficiency and very low I_Q under light load conditions. ECO mode extends the battery life through reduction of the quiescent current during light load conditions and system standby.

The LM3691 is available in a 6-pin DSBGA package. Only three external surface-mount components, a 1- μ H inductor, a 4.7- μ F input capacitor, and a 4.7- μ F output capacitor, are required.

Device Information⁽¹⁾

PART NUMBER	PACKAGE	BODY SIZE (MAX)
LM3691	DSBGA (6)	1.59 mm x 1.295 mm

(1) For all available packages, see the orderable addendum at the end of the data sheet.

Typical Application Circuit

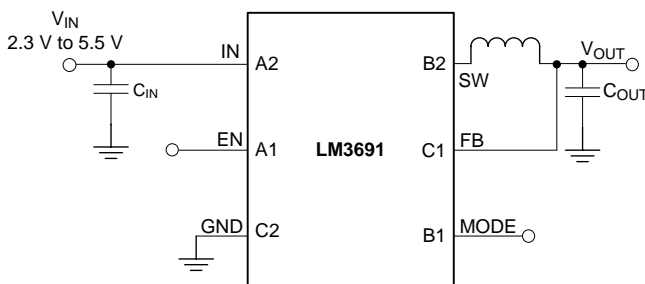

Efficiency vs. Output Current ($V_{OUT} = 1.8$ V, ECO Mode)

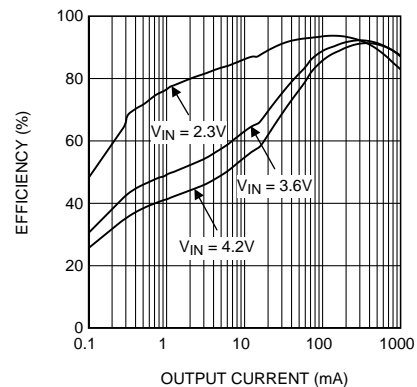

Table of Contents

1 Features	1	8.4 Device Functional Modes.....	16
2 Applications	1	9 Application and Implementation	17
3 Description	1	9.1 Application Information.....	17
4 Revision History	2	9.2 Typical Application	17
5 Voltage Options	3	10 Power Supply Recommendations	20
6 Pin Configuration and Functions	4	11 Layout	21
7 Specifications	5	11.1 Layout Guidelines	21
7.1 Absolute Maximum Ratings	5	11.2 Layout Example	22
7.2 ESD Ratings.....	5	11.3 DSBGA Package Assembly and Use	22
7.3 Recommended Operating Conditions.....	5	12 Device and Documentation Support	23
7.4 Thermal Information	5	12.1 Device Support.....	23
7.5 Electrical Characteristics	6	12.2 Documentation Support	23
7.6 Typical Characteristics	7	12.3 Community Resources.....	23
8 Detailed Description	14	12.4 Trademarks	23
8.1 Overview	14	12.5 Electrostatic Discharge Caution.....	23
8.2 Functional Block Diagram	14	12.6 Glossary	23
8.3 Feature Description.....	15	13 Mechanical, Packaging, and Orderable Information	23

4 Revision History

NOTE: Page numbers for previous revisions may differ from page numbers in the current version.

Changes from Revision I (May 2013) to Revision J	Page
<ul style="list-style-type: none"> Added <i>Device Information</i> and <i>Pin Configuration and Functions</i> sections, <i>ESD Ratings</i> table, <i>Feature Description</i>, <i>Device Functional Modes</i>, <i>Application and Implementation</i>, <i>Power Supply Recommendations</i>, <i>Layout</i>, <i>Device and Documentation Support</i>, and <i>Mechanical, Packaging, and Orderable Information</i> sections 	1

Changes from Revision H (April 2013) to Revision I	Page
<ul style="list-style-type: none"> Changed layout of National Data Sheet to TI format 	22

5 Voltage Options

ORDERABLE DEVICE ⁽¹⁾⁽²⁾	VOLTAGE OPTION (V)
LM3691TL-0.75/NOPB	0.75
LM3691TLX-0.75/NOPB	0.75
LM3691TL-1.0/NOPB	1
LM3691TLX-1.0/NOPB	1
LM3691TL-1.2/NOPB	1.2
LM3691TLX-1.2/NOPB	1.2
LM3691TL-1.5/NOPB	1.5
LM3691TLX-1.5/NOPB	1.5
LM3691TL-1.8/NOPB	1.8
LM3691TLX-1.8/NOPB	1.8
LM3691TL-2.5/NOPB	2.5
LM3691TLX-2.5/NOPB	2.5
LM3691TL-3.3/NOPB	3.3
LM3691TLX-3.3/NOPB	3.3

- (1) For the most current package and ordering information, see the Package Option Addendum at the end of this document, or see the TI web site at www.ti.com.
- (2) Package drawings, thermal data, and symbolization are available at www.ti.com/packaging.

6 Pin Configuration and Functions

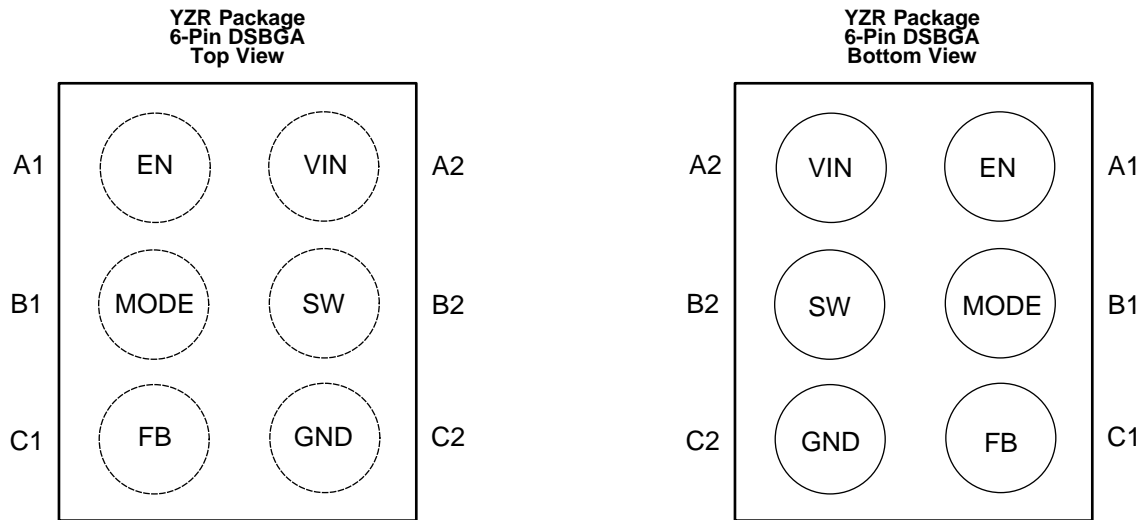

Pin Functions

PIN		TYPE ⁽¹⁾	DESCRIPTION
NO.	NAME		
A1	EN	I	EN pin. The device is in shutdown mode when voltage to this pin is < 0.4 V and enabled when > 1.2 V. Do not leave this pin floating
A2	VIN	P	Power supply input. Connect to the input filter capacitor. (See Typical Application Circuit.)
B1	MODE	I	MODE pin: Mode = 1, forced PWM; mode = 0, ECO Do not leave this pin floating.
B2	SW	A	Switching node connection to the internal PFET switch and NFET synchronous rectifier.
C1	FB	A	Feedback analog input. Connect directly to the output filter capacitor. (See Typical Application Circuit.)
C2	GND	G	Ground pin.

(1) A: Analog Pin, D: Digital Pin, G: Ground Pin, P: Power Pin, I: Input Pin, I/O: Input/Output, O: Output Pin

7 Specifications

7.1 Absolute Maximum Ratings

over operating free-air temperature range (unless otherwise noted)⁽¹⁾⁽²⁾

	MIN	MAX	UNIT
V _{IN} pin to GND	-0.2	6	V
EN, MODE, FB, SW pins	(GND - 0.2)	V _{IN} + 0.2	V
Junction temperature (T _{J-MAX})		150	°C
Continuous power dissipation ⁽³⁾	Internally Limited		
Maximum lead temperature (soldering, 10 seconds)		260	°C
Storage temperature, T _{stg}		150	°C

- (1) Stresses beyond those listed under *Absolute Maximum Ratings* may cause permanent damage to the device. These are stress ratings only, which do not imply functional operation of the device at these or any other conditions beyond those indicated under *Recommended Operating Conditions*. Exposure to absolute-maximum-rated conditions for extended periods may affect device reliability.
- (2) If Military/Aerospace specified devices are required, contact the TI Sales Office/Distributors for availability and specifications.
- (3) Internal thermal shutdown circuitry protects the device from permanent damage. Thermal shutdown engages at T_J = 150°C (typical) and disengages at T_J = 130°C (typical).

7.2 ESD Ratings

		VALUE	UNIT
V _(ESD) Electrostatic discharge	Human-body model (HBM), per ANSI/ESDA/JEDEC JS-001 ⁽¹⁾	±2000	V
	Machine model	±200	

- (1) JEDEC document JEP155 states that 500-V HBM allows safe manufacturing with a standard ESD control process.

7.3 Recommended Operating Conditions

over operating free-air temperature range (unless otherwise noted)

	MIN	NOM	MAX	UNIT
Input voltage	2.3		5.5	V
Recommended load current	0		1000	mA
Junction temperature, T _J	-30		125	°C
Ambient temperature, T _A ⁽¹⁾	-30		85	°C

- (1) In applications where high power dissipation and/or poor package resistance is present, the maximum ambient temperature may have to be derated. Maximum ambient temperature (T_{A-MAX}) is dependent on the maximum operating junction temperature (T_{J-MAX}), the maximum power dissipation of the device in the application (P_{D-MAX}) and the junction to ambient thermal resistance of the package (R_{θJA}) in the application, as given by the following equation: T_{A-MAX} = T_{J-MAX} - (R_{θJA} × P_{D-MAX}). Due to the pulsed nature of testing the part, the temp in *Electrical Characteristics* is specified as T_A = T_J.

7.4 Thermal Information

THERMAL METRIC ⁽¹⁾		LM3691	UNIT
		YZR (DSBGA)	
		6 PINS	
R _{θJA}	Junction-to-ambient thermal resistance ⁽²⁾	85	°C/W

- (1) For more information about traditional and new thermal metrics, see the *Semiconductor and IC Package Thermal Metrics* application report, [SPRA953](#).
- (2) Junction-to-ambient thermal resistance is highly application and board layout dependent. In applications where high power dissipation exists, special care must be given to thermal dissipation issues in board design.

7.5 Electrical Characteristics

Unless otherwise specified, specifications apply to the LM3691 open-loop *Typical Application Circuit* with $V_{IN} = EN = 3.6\text{ V}$; typical limits are for $T_A = 25^\circ\text{C}$ and minimum and maximum limits apply over the operating ambient temperature range ($-30^\circ\text{C} \leq T_A = T_J \leq +85^\circ\text{C}$).⁽¹⁾⁽²⁾⁽³⁾

PARAMETER	TEST CONDITIONS	MIN	TYP	MAX	UNIT
V_{FB} Feedback voltage	PWM mode no load $V_{OUT} = 1.1\text{ V to }3.3\text{ V}$	-1%		1%	
	PWM mode no load $V_{OUT} = 0.75\text{ V to }1\text{ V}$	-10		10	mV
I_{SHDN} Shutdown supply current	$EN = 0\text{ V}$		0.03	1	μA
I_{Q_ECO} ECO mode I_Q	ECO mode		64	80	μA
I_{Q_PWM} PWM mode I_Q	PWM mode		490	600	μA
$R_{DSON(P)}$ Pin-pin resistance for PFET	$V_{IN} = V_{GS} = 3.6\text{ V}$, $I_O = 200\text{ mA}$		160	250	$\text{m}\Omega$
$R_{DSON(N)}$ Pin-pin resistance for NFET	$V_{IN} = V_{GS} = 3.6\text{ V}$, $I_O = -200\text{ mA}$		115	180	$\text{m}\Omega$
I_{LIM} Switch peak current limit	Open loop	1250	1500	1700	mA
V_{IH} Logic high input		1.2			V
V_{IL} Logic low input				0.4	V
$I_{EN,MODE}$ Input current			0.01	1	μA
F_{SW} Switching frequency	PWM mode	3.6	4	4.4	MHz
V_{ON} UVLO threshold ⁽⁴⁾	V_{IN} rising, $T_A = 25^\circ\text{C}$		2.2	2.29	V
	V_{IN} falling		2.1		V
$T_{STARTUP}$ Start time ⁽⁵⁾	$T_A = 25^\circ\text{C}$	70	145	300	μs

(1) All voltages are with respect to the potential at the GND pin.

(2) Minimum and maximum limits are specified by design, test or statistical analysis. Typical numbers represent the most likely norm.

(3) The parameters in the electrical characteristic table are tested under open-loop conditions at $V_{IN} = 3.6\text{ V}$ unless otherwise specified. For performance over the input voltage range and closed loop condition, refer to the datasheet curves.

(4) The UVLO rising threshold minus the falling threshold is always positive.

(5) Specified by design. Not production tested.

7.6 Typical Characteristics

LM3691TL *Typical Application Circuit*, $V_{IN} = 3.6\text{ V}$, $V_{OUT} = 1.8\text{ V}$, $T_A = 25^\circ\text{C}$, $L = 1\ \mu\text{H}$, 2520, (LQM2HP1R0), $C_{IN} = C_{OUT} = 4.7\ \mu\text{F}$, 0603(1608), 6.3 V, (C1608X5R0J475K) unless otherwise noted.

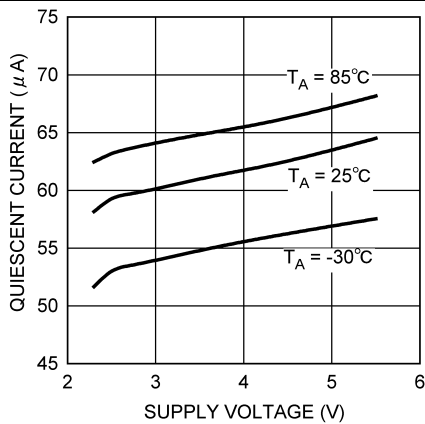

Figure 1. Quiescent Supply Current vs Supply Voltage No Switching, ECO Mode

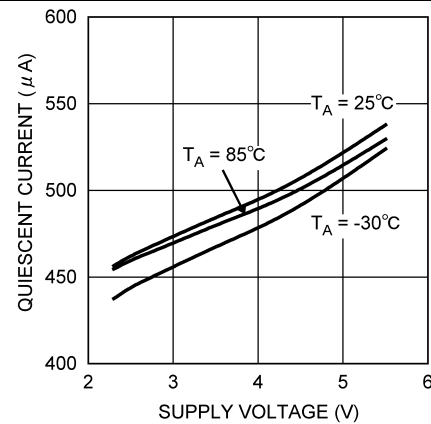
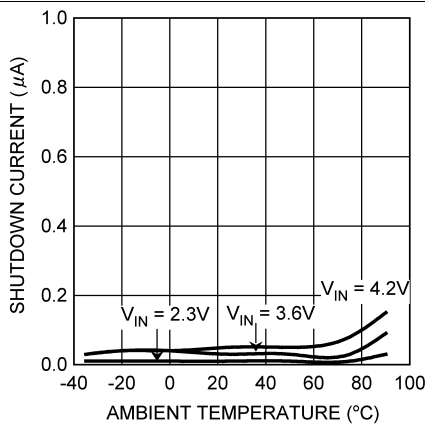
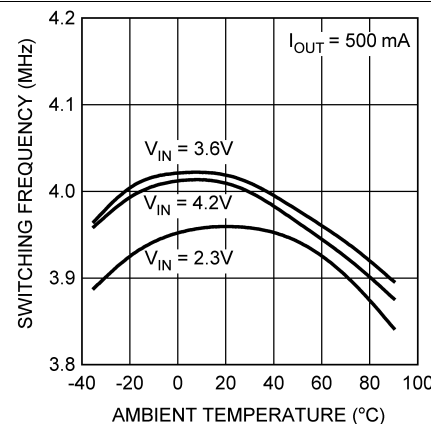

Figure 2. Quiescent Supply Current vs Supply Voltage No Switching, PWM Mode



$V_{OUT} = 1.8\text{ V}$

Figure 3. Shutdown Current vs Temperature



$V_{OUT} = 1.8\text{ V}$

Figure 4. Switching Frequency vs Temperature, PWM Mode

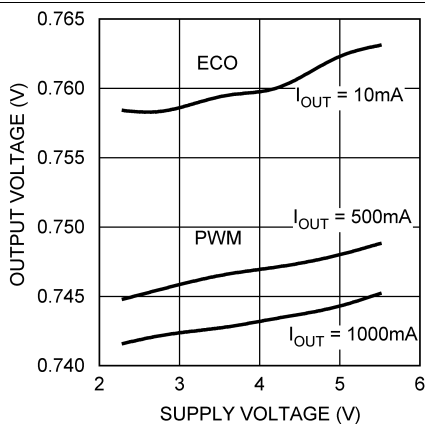

$V_{OUT} = 0.75\text{ V}$

Figure 5. Output Voltage vs Supply Voltage

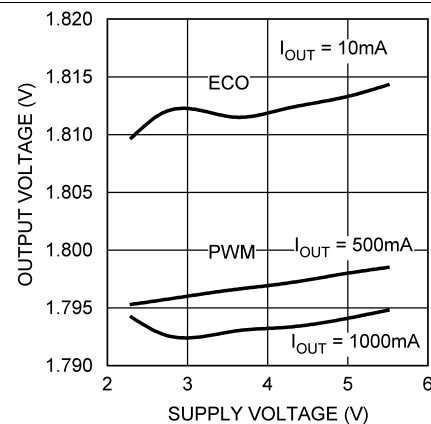

$V_{OUT} = 1.8\text{ V}$

Figure 6. Output Voltage vs Supply Voltage

Typical Characteristics (continued)

LM3691TL *Typical Application Circuit*, $V_{IN} = 3.6\text{ V}$, $V_{OUT} = 1.8\text{ V}$, $T_A = 25^\circ\text{C}$, $L = 1\ \mu\text{H}$, 2520, (LQM2HP1R0), $C_{IN} = C_{OUT} = 4.7\ \mu\text{F}$, 0603(1608), 6.3 V, (C1608X5R0J475K) unless otherwise noted.

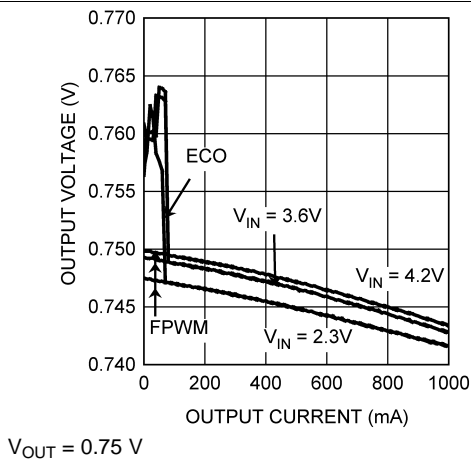

Figure 7. Output Voltage vs Output Current

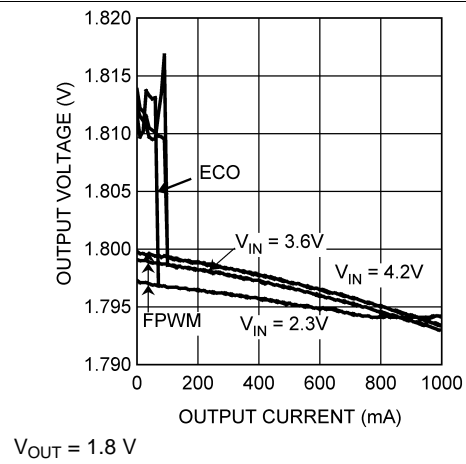

Figure 8. Output Voltage vs Output Current

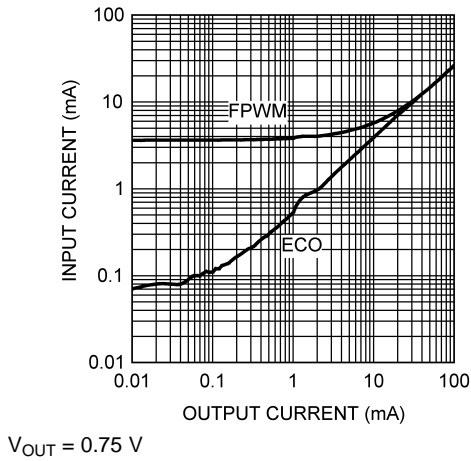

Figure 9. Input Current vs Output Current

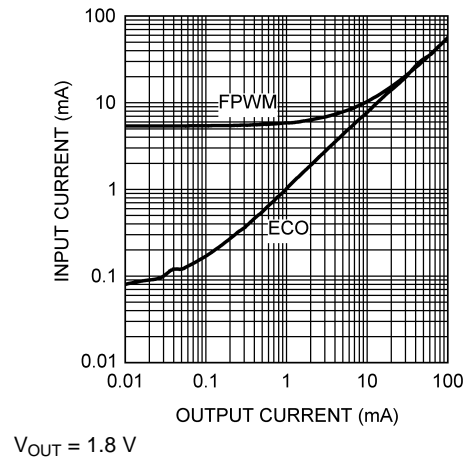

Figure 10. Input Current vs Output Current

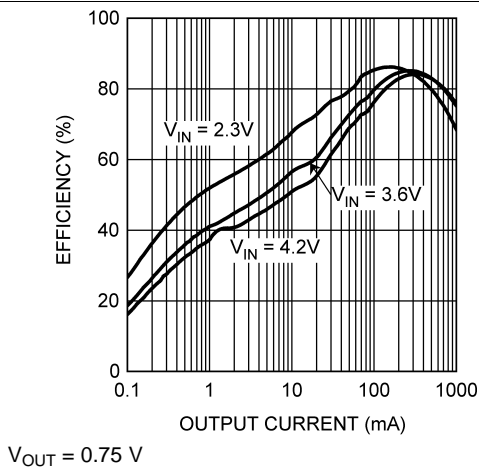

Figure 11. Efficiency vs, Output Current, ECO Mode

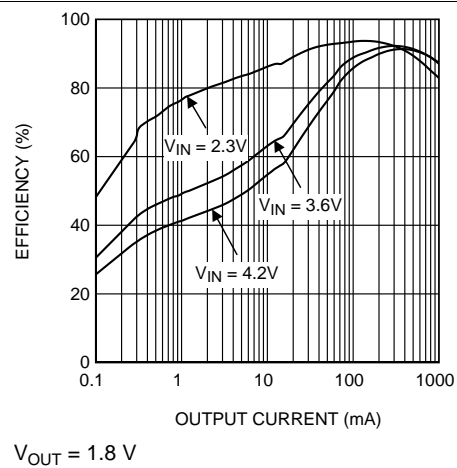
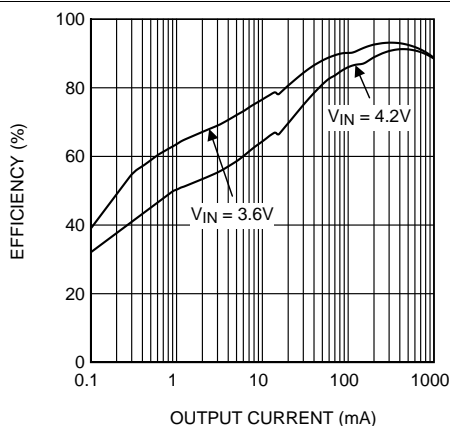

Figure 12. Efficiency vs Output Current, ECO Mode

Typical Characteristics (continued)

LM3691TL *Typical Application Circuit*, $V_{IN} = 3.6\text{ V}$, $V_{OUT} = 1.8\text{ V}$, $T_A = 25^\circ\text{C}$, $L = 1\ \mu\text{H}$, 2520, (LQM2HP1R0), $C_{IN} = C_{OUT} = 4.7\ \mu\text{F}$, 0603(1608), 6.3 V, (C1608X5R0J475K) unless otherwise noted.



$V_{OUT} = 2.5\text{ V}$

Figure 13. Efficiency vs Output Current, ECO Mode

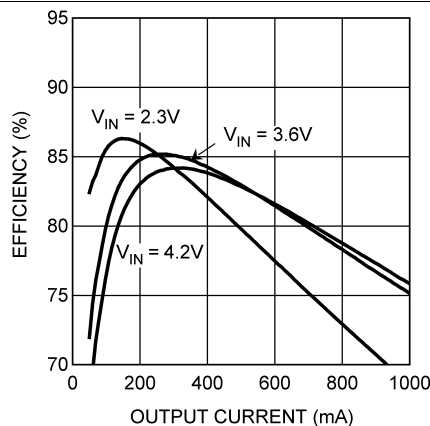

$V_{OUT} = 0.75\text{ V}$

Figure 14. Efficiency vs Output Current, FPWM Mode

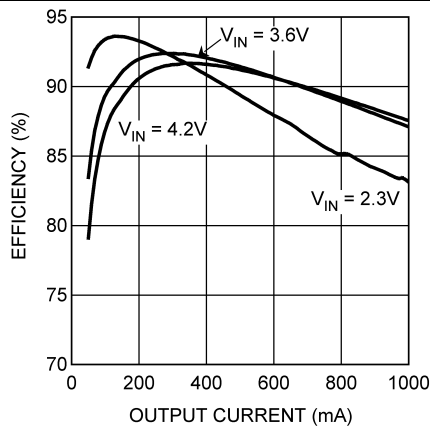

$V_{OUT} = 1.8\text{ V}$

Figure 15. Efficiency vs Output Current, FPWM Mode

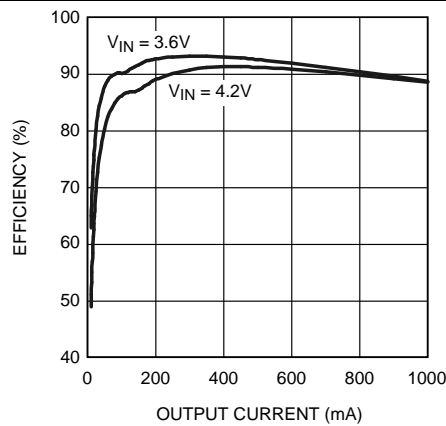

$V_{OUT} = 2.5\text{ V}$

Figure 16. Efficiency vs Output Current, FPWM Mode

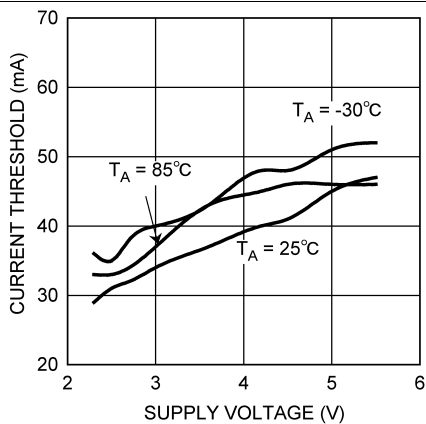

$V_{OUT} = 0.75\text{ V}$

Figure 17. Load Current Threshold vs Supply Voltage, ECO Mode to PWM Mode

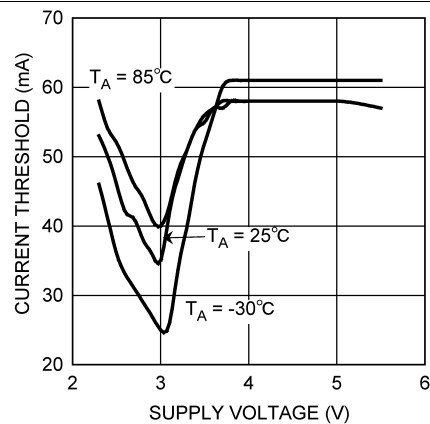

$V_{OUT} = 1.8\text{ V}$

Figure 18. Load Current Threshold vs Supply Voltage, ECO Mode to PWM Mode

Typical Characteristics (continued)

LM3691TL *Typical Application Circuit*, $V_{IN} = 3.6\text{ V}$, $V_{OUT} = 1.8\text{ V}$, $T_A = 25^\circ\text{C}$, $L = 1\ \mu\text{H}$, 2520, (LQM2HP1R0), $C_{IN} = C_{OUT} = 4.7\ \mu\text{F}$, 0603(1608), 6.3 V, (C1608X5R0J475K) unless otherwise noted.

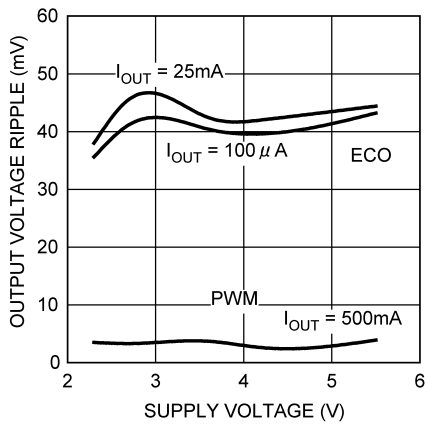

$V_{OUT} = 0.75\text{ V}$

Figure 19. Output Voltage Ripple vs Supply Voltage

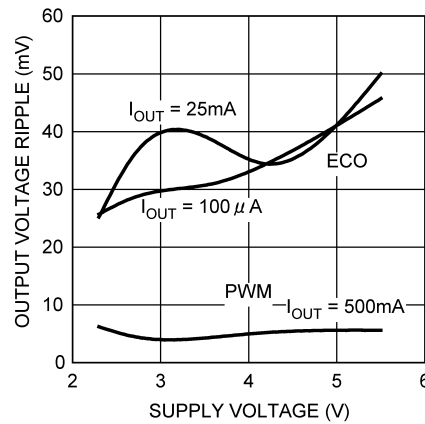

$V_{OUT} = 1.8\text{ V}$

Figure 20. Output Voltage Ripple vs Supply Voltage

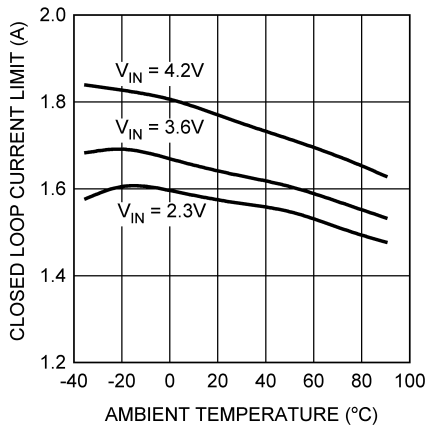

$V_{OUT} = 0.75\text{ V}$

Figure 21. Closed Loop Current Limit vs Temperature

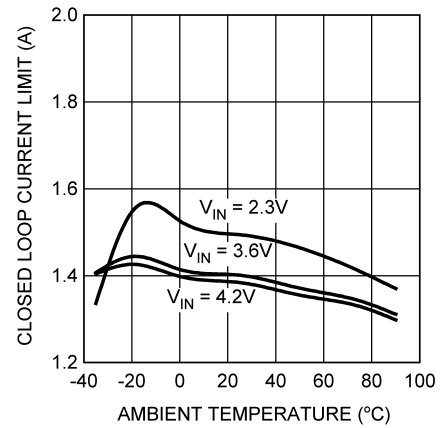

$V_{OUT} = 1.8\text{ V}$

Figure 22. Closed Loop Current Limit vs Temperature

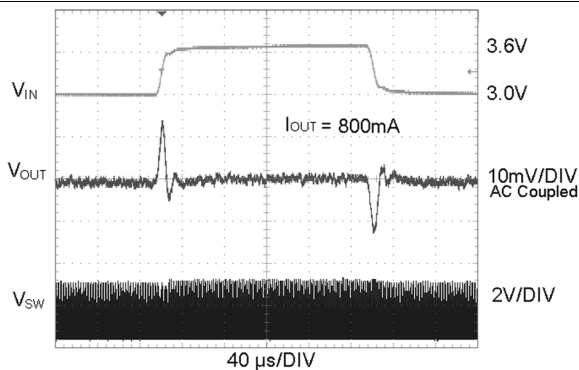

$V_{OUT} = 0.75\text{ V}$

Figure 23. Line Transient Reponse, PWM Mode

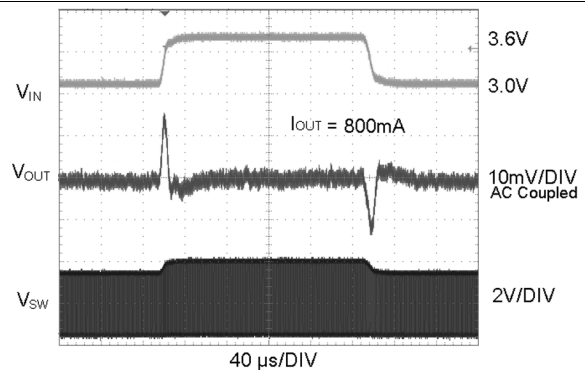

$V_{OUT} = 1.8\text{ V}$

Figure 24. Line Transient Reponse, PWM Mode

Typical Characteristics (continued)

LM3691TL *Typical Application Circuit*, $V_{IN} = 3.6\text{ V}$, $V_{OUT} = 1.8\text{ V}$, $T_A = 25^\circ\text{C}$, $L = 1\ \mu\text{H}$, 2520, (LQM2HP1R0), $C_{IN} = C_{OUT} = 4.7\ \mu\text{F}$, 0603(1608), 6.3 V, (C1608X5R0J475K) unless otherwise noted.

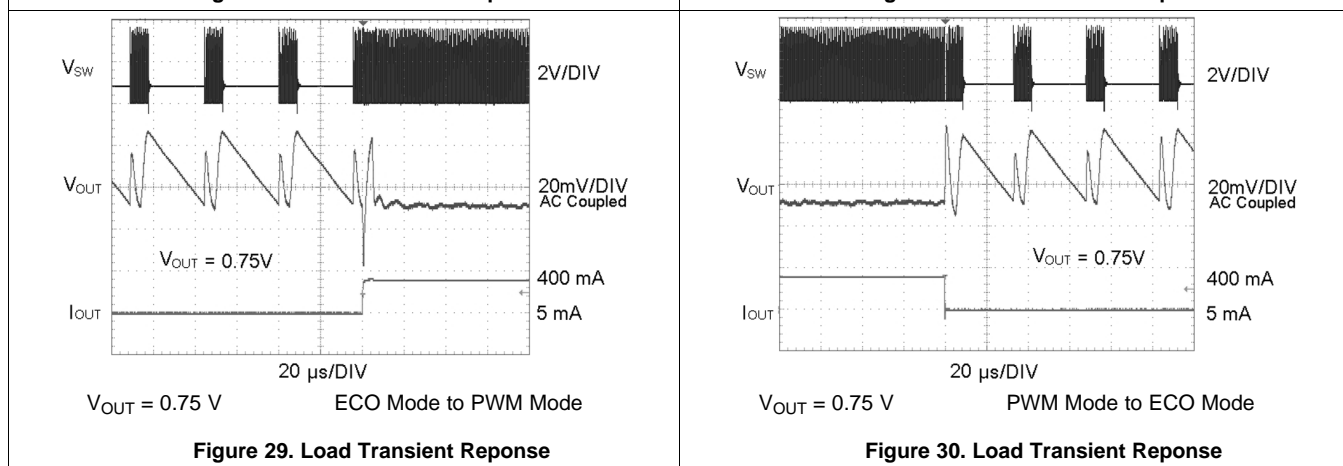
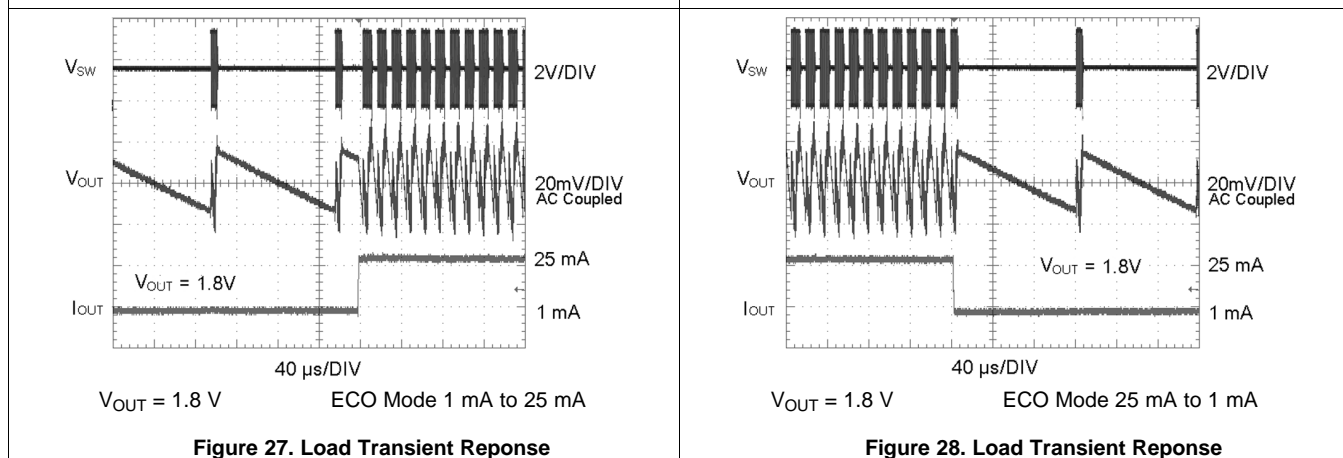
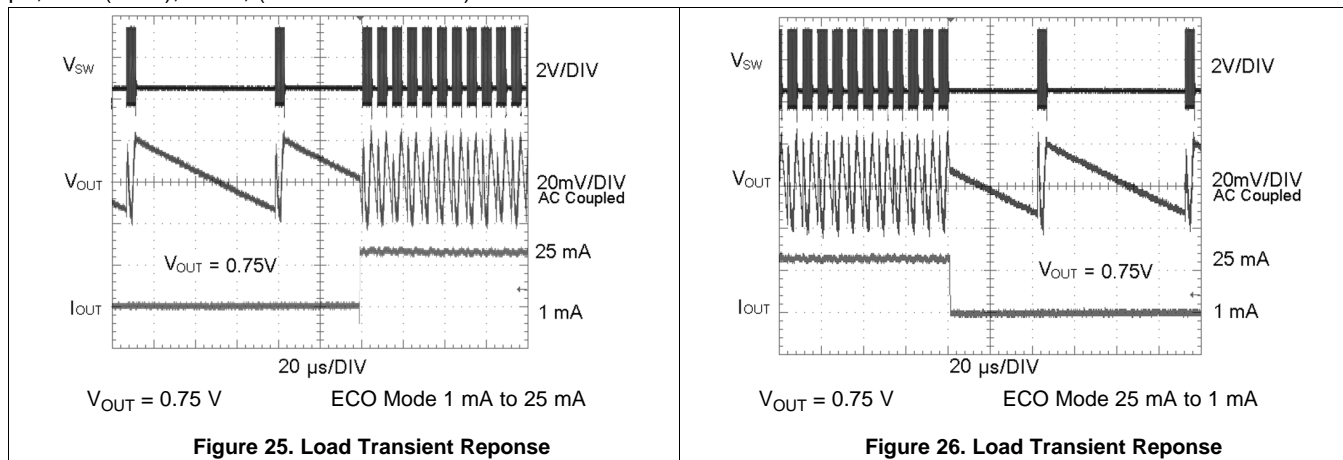

Typical Characteristics (continued)

LM3691TL *Typical Application Circuit*, $V_{IN} = 3.6\text{ V}$, $V_{OUT} = 1.8\text{ V}$, $T_A = 25^\circ\text{C}$, $L = 1\ \mu\text{H}$, 2520, (LQM2HP1R0), $C_{IN} = C_{OUT} = 4.7\ \mu\text{F}$, 0603(1608), 6.3 V, (C1608X5R0J475K) unless otherwise noted.

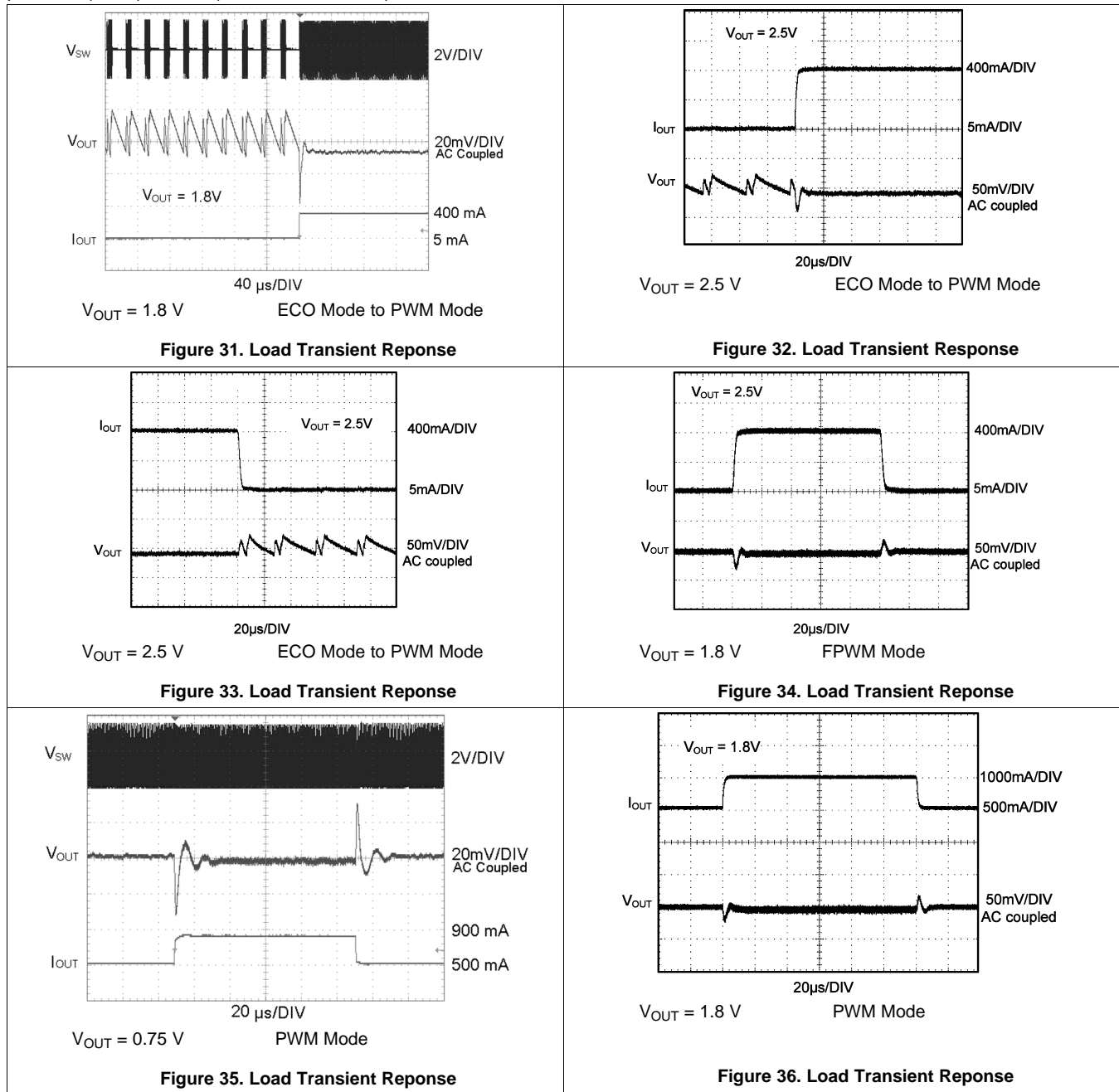

Typical Characteristics (continued)

LM3691TL *Typical Application Circuit*, $V_{IN} = 3.6\text{ V}$, $V_{OUT} = 1.8\text{ V}$, $T_A = 25^\circ\text{C}$, $L = 1\ \mu\text{H}$, 2520, (LQM2HP1R0), $C_{IN} = C_{OUT} = 4.7\ \mu\text{F}$, 0603(1608), 6.3 V, (C1608X5R0J475K) unless otherwise noted.

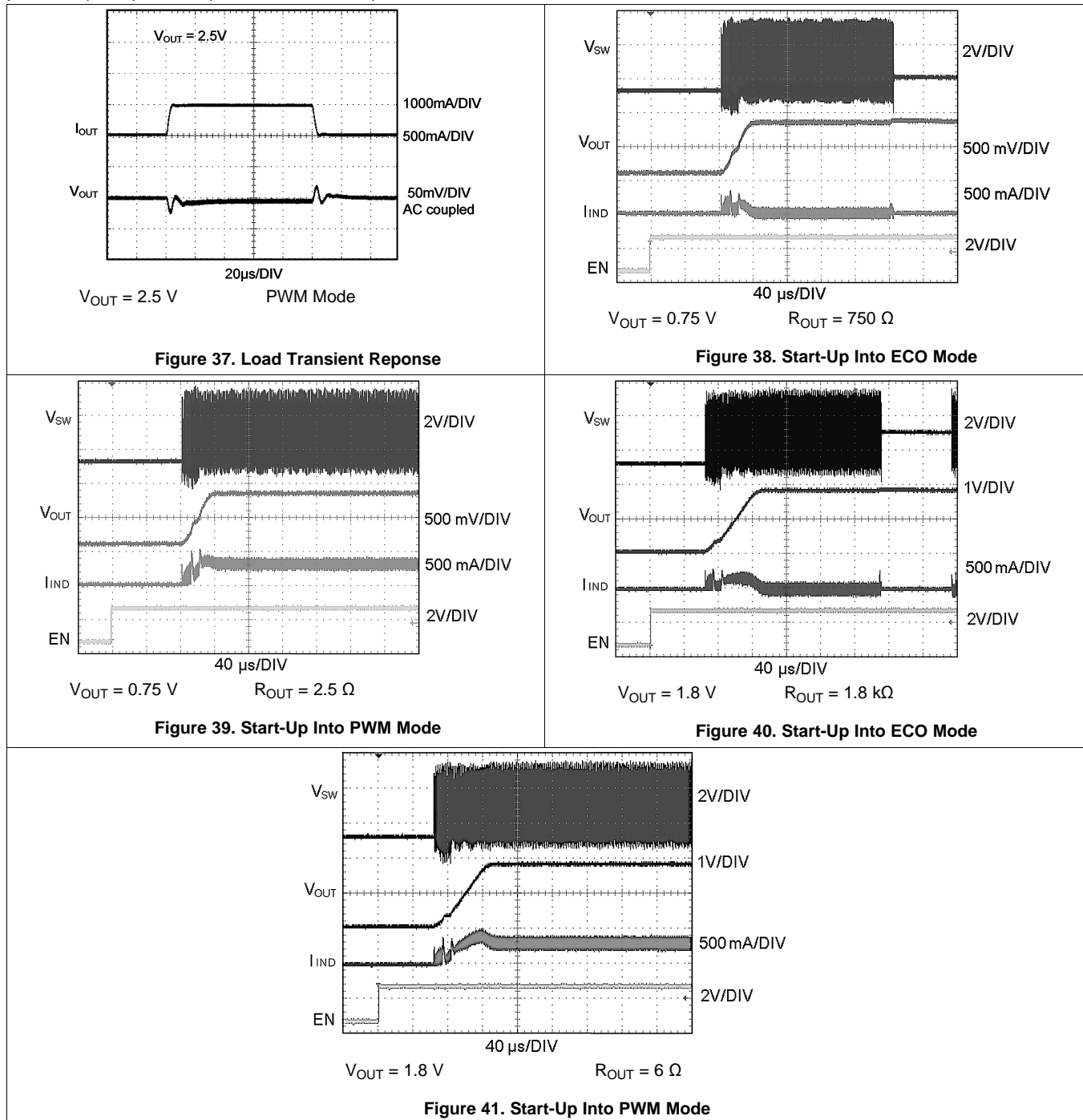

8 Detailed Description

8.1 Overview

The LM3691, a high-efficiency, step-down DC-DC switching buck converter, delivers a constant voltage from either a single Li-Ion or three cell NiMH/NiCd battery to portable devices such as cell phones and PDAs. Using a voltage mode architecture with synchronous rectification, the LM3691 can deliver up to 1000 mA depending on the input voltage and output voltage, ambient temperature, and the inductor chosen.

There are three modes of operation depending on the current required: pulse width modulation (PWM), ECO, and shutdown. The device operates in PWM mode at load currents of approximately 50 mA (typical) or higher. Lighter output current loads cause the device to automatically switch into ECO mode for reduced current consumption and a longer battery life. Shutdown mode turns off the device, offering the lowest current consumption ($I_{SHUTDOWN} = 0.03 \mu\text{A}$ typical). Additional features include soft start, undervoltage protection, current overload protection, and thermal shutdown protection. As shown in [Typical Application Circuit](#), only three external power components are required for implementation.

8.2 Functional Block Diagram

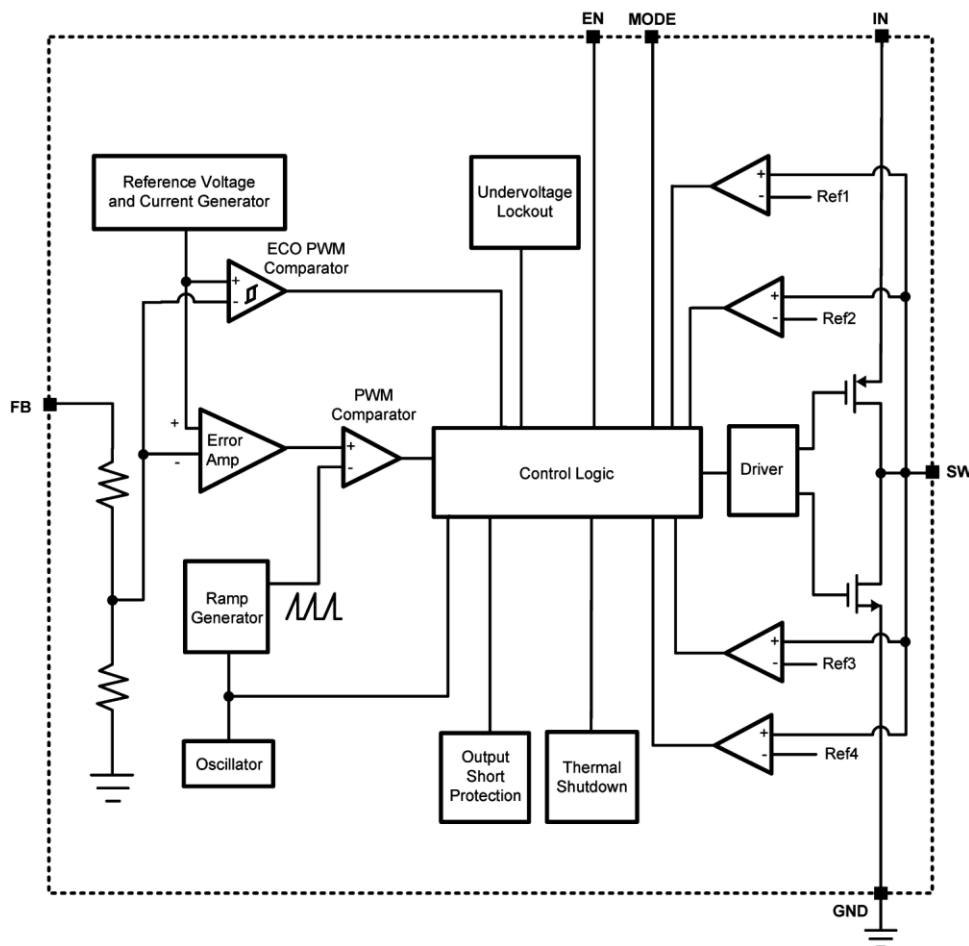

8.3 Feature Description

8.3.1 Circuit Operation

The LM3691 operates as follows. During the first portion of each switching cycle, the control block in the LM3691 turns on the internal PFET switch. This allows current to flow from the input through the inductor to the output filter capacitor and load. The inductor limits the current to a ramp with a slope of $(V_{IN} - V_{OUT})/L$, by storing energy in a magnetic field. During the second portion of each cycle, the controller turns the PFET switch off, blocking current flow from the input, and then turns the NFET synchronous rectifier on. The inductor draws current from ground through the NFET to the output filter capacitor and load, which ramps the inductor current down with a slope of $-V_{OUT}/L$.

The output filter stores charge when the inductor current is high, and releases it when low, smoothing the voltage across the load. The output voltage is regulated by modulating the PFET switch on time to control the average current sent to the load. The effect is identical to sending a duty-cycle modulated rectangular wave formed by the switch and synchronous rectifier at the SW pin to a low-pass filter formed by the inductor and output filter capacitor. The output voltage is equal to the average voltage at the SW pin.

8.3.2 PWM Operation

During PWM operation, the converter operates as a voltage-mode controller with input-voltage feed forward. This allows the converter to achieve excellent load and line regulation. The DC gain of the power stage is proportional to the input voltage. To eliminate this dependence, feed forward inversely proportional to the input voltage is introduced. While in PWM mode, the output voltage is regulated by switching at a constant frequency and then modulating the energy per cycle to control power to the load. At the beginning of each clock cycle the PFET switch is turned on, and the inductor current ramps up until the comparator trips and the control logic turns off the switch. The current limit comparator can also turn off the switch in case the current limit of the PFET is exceeded. Then the NFET switch is turned on, and the inductor current ramps down. The next cycle is initiated by the clock turning off the NFET and turning on the PFET.

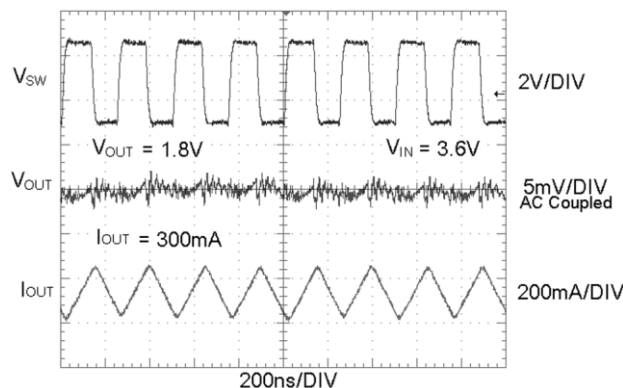

Figure 42. Typical PWM Operation

8.3.2.1 Internal Synchronous Rectification

While in PWM mode, the LM3691 uses an internal NFET as a synchronous rectifier to reduce rectifier forward voltage drop and associated power loss. Synchronous rectification provides a significant improvement in efficiency whenever the output voltage is relatively low compared to the voltage drop across an ordinary rectifier diode.

8.3.2.2 Current Limiting

A current limit feature allows the LM3691 to protect itself and external components during overload conditions. PWM mode implements current limit using an internal comparator that trips at 1500 mA (typical). If the output is shorted to ground, and the output voltage becomes lower than 0.3V (typical), the device enters a timed current-limit mode where the switching frequency is one fourth, and NFET synchronous rectifier is disabled, thus preventing excess current and thermal runaway.

Feature Description (continued)

8.3.3 ECO Operation

Setting the MODE pin low places the LM3691 in Auto mode. By doing so the part switches from ECONomy (ECO) state to forced pulse width modulation (FPWM) state based on output load current. At light loads (less than 50 mA), the converter enters ECO mode. In this mode the part operates with low I_Q . During ECO operation, the converter positions the output voltage slightly higher (30 mV typical) than the nominal output voltage in FPWM operation. Because the reference is set higher, the output voltage increases to reach the target voltage when the part goes from sleep state to switching state. Once this voltage is reached the converter enters sleep mode, thus reducing switching losses and improving light load efficiency. The output voltage ripple is slightly higher in ECO mode (30 mV peak-to-peak ripple typical).

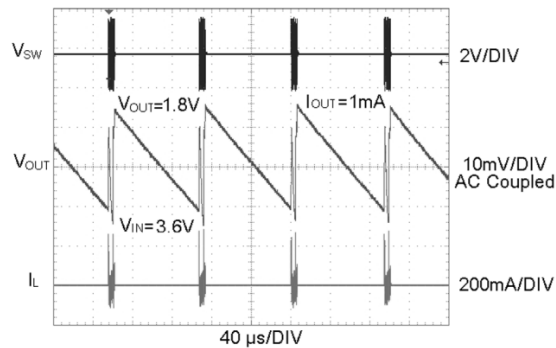

Figure 43. Typical ECO Operation

8.3.4 Soft-Start

The LM3691 has a soft-start circuit that limits in-rush current during start-up. Output voltage increase rate is 30 mV/μs (at $V_{OUT} = 1.8$ V typical) during soft start.

8.3.5 Thermal Shutdown Protection

The LM3691 has a thermal overload protection function that operates to protect itself from short-term misuse and overload conditions. When the junction temperature exceeds around 150°C, the device inhibits operation. Both the PFET and the NFET are turned off. When the temperature drops below 130°C, normal operation resumes. Prolonged operation in thermal overload conditions may damage the device and is considered bad practice.

8.3.6 Overtemperature Maximum Load

Table 1. Maximum Overtemperature Load Recommendations

V_{IN}	MAXIMUM LOAD
2.5 V to 5.5 V	1000 mA
2.3 V to 2.5 V	650 mA

8.4 Device Functional Modes

8.4.1 Forced PWM Mode

Setting the MODE pin high (> 1.2 V) places the LM3691 in FPWM. The device is in FPWM regardless of the load.

8.4.2 Shutdown Mode

Setting the EN input pin low (< 0.4 V) places the LM3691 in shutdown mode. During shutdown the PFET switch, NFET switch, reference, control and bias circuitry of the LM3691 are turned off. Setting EN high (> 1.2 V) enables normal operation. When turning on the device with EN soft start is activated. EN pin must be set low to turn off the LM3691 during system power up and undervoltage conditions when the supply is less than 2.3 V. Do not leave the EN pin floating.

9 Application and Implementation

NOTE

Information in the following applications sections is not part of the TI component specification, and TI does not warrant its accuracy or completeness. TI's customers are responsible for determining suitability of components for their purposes. Customers should validate and test their design implementation to confirm system functionality.

9.1 Application Information

The LM3691 step-down DC-DC converter is optimized for powering ultralow-voltage circuits from a single Li-Ion cell (2.7 V to 5.5 V) or 3-cell NiMH/NiCd (2.4 V to 4.5 V) batteries. It provides up to 1-A load current over an input voltage range from 2.3 V to 5.5 V. Seven different fixed voltage output options are available to cover all commonly used voltage rails (0.75 V, 1 V, 1.2 V, 1.5 V, 1.8 V, 2.5 V, 3.3 V).

9.2 Typical Application

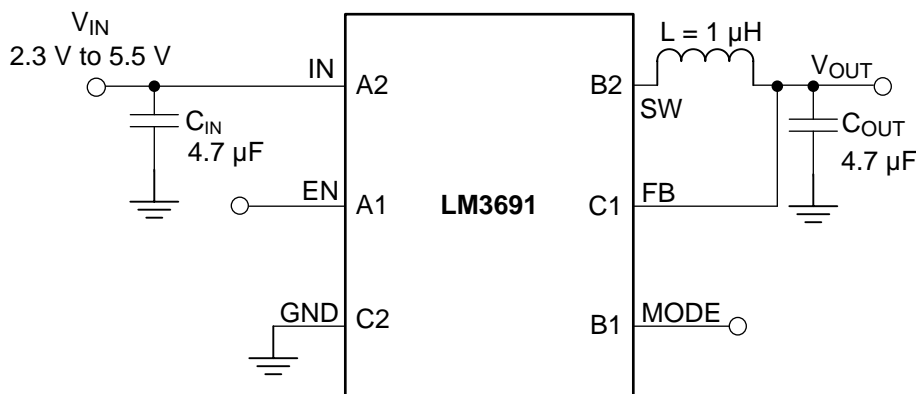

Figure 44. LM3691 Typical Application

9.2.1 Design Requirements

For typical step-down DC-DC applications, use the parameters listed in [Table 2](#).

Table 2. Design Parameters

DESIGN PARAMETER	EXAMPLE VALUE
Minimum input voltage	2.5 V
Minimum output voltage	1.8 V
Output current	150 mA

9.2.2 Detailed Design Procedure

9.2.2.1 Inductor Selection

DC bias current characteristics of inductors must be considered. Different manufacturers follow different saturation current rating specifications, so attention must be given to details. DC bias curves should be requested from the manufacturer as part of the inductor selection process.

Minimum value of inductance to specify good performance is 0.5 μH at 1.5 A (I_{LIM} typical) bias current over the ambient temp range. DC resistance of the inductor must be less than 0.1 Ω for good efficiency at high-current condition. The inductor AC loss (resistance) also affects conversion efficiency. Higher Q factor at switching frequency usually gives better efficiency at light load to middle load.

[Table 3](#) lists suggested inductors and suppliers.

Table 3. Suggested Inductors and Their Suppliers

MODEL	VENDOR	DIMENSIONS L x W x H (mm)	DCR (mΩ)
LQM2HPN1R0MG0	Murata	2.5 × 2.0 × 1.0	55
MLP2520S1R0L	TDK	2.5 × 2.0 × 1.0	60
KSLI252010BG1R0	Hltachi Metals	2.5 × 2.0 × 1.0	80
MIPSZ2012D1R0	FDK	2.0 × 1.25 × 1.0	90

9.2.2.2 Input Capacitor Selection

A ceramic input capacitor of 4.7 μF, 6.3 V/10 V is sufficient for most applications. Place the input capacitor as close as possible to the VIN pin and GND pin of the device. A larger value or higher voltage rating may be used to improve input voltage filtering. Use X7R, X5R or B types; do not use Y5V or F. DC bias characteristics of ceramic capacitors must be considered when selecting case sizes like 0402. *Minimum input capacitance to ensure good performance is 2.2 μF at maximum input voltage DC bias including tolerances and over ambient temperature range.*

The input filter capacitor supplies current to the PFET (high-side) switch in the first half of each cycle and reduces voltage ripple imposed on the input power source. A ceramic capacitor's low ESR provides the best noise filtering of the input voltage spikes due to this rapidly changing current. Select an input filter capacitor with sufficient ripple current rating. The input current ripple can be calculated as:

$$I_{RMS} = I_{OUTMAX} \times \sqrt{\frac{V_{OUT}}{V_{IN}} \times \left(1 - \frac{V_{OUT}}{V_{IN}} + \frac{r^2}{12}\right)}$$

$$r = \frac{(V_{IN} - V_{OUT}) \times V_{OUT}}{L \times f \times I_{OUTMAX} \times V_{IN}}$$
(1)

9.2.2.3 Output Capacitor Selection

Use a 4.7-μF, 6.3-V ceramic capacitor, X7R, X5R or B types; do not use Y5V or F. DC bias voltage characteristics of ceramic capacitors must be considered. DC bias characteristics vary from manufacturer to manufacturer, and DC bias curves should be requested from the manufacturer as part of the capacitor selection process. The output filter capacitor smooths out current flow from the inductor to the load, helps maintain a steady output voltage during transient load changes, and reduces output voltage ripple. These capacitors must be selected with sufficient capacitance and sufficiently low equivalent series resistance (ESR) to perform these functions. *Minimum output capacitance to specify good performance is 2.2 μF at the output voltage DC bias including tolerances and over ambient temperature range.*

The output voltage ripple is caused by the charging and discharging of the output capacitor and also due to its R_{ESR} and can be calculated as:

Voltage peak-to-peak ripple due to capacitance is shown in [Equation 2](#):

$$V_{PP-C} = \frac{I_{RIPPLE}}{4 * f * C}$$
(2)

Voltage peak-to-peak ripple due to ESR [Equation 3](#):

$$V_{PP-ESR} = (2 \times I_{RIPPLE}) \times R_{ESR}$$
(3)

Because these two components are out of phase the RMS value can be used to get an approximate value of peak-to-peak ripple.

Voltage peak-to-peak ripple, root mean squared equals:

$$V_{PP-RMS} = \sqrt{V_{PP-C}^2 + V_{PP-ESR}^2}$$
(4)

Note that the output voltage ripple is dependent on the current ripple and the ESR of the output capacitor (R_{ESR}). The R_{ESR} is frequency dependent (as well as temperature dependent); make sure the value used for calculations is at the switching frequency of the part.

Table 4 lists suggested capacitors and suppliers.

Table 4. Suggested Capacitors and Their Suppliers

MODEL	TYPE	VENDOR	VOLTAGE RATING (V)	CASE SIZE INCH (mm)
4.7 μF for C_{IN} and C_{OUT}				
C1608X5R0J475K	Ceramic	TDK	6.3	0603 (1608)
C1608X5R1A475K	Ceramic	TDK	10.0	0603 (1608)

9.2.3 Application Curves

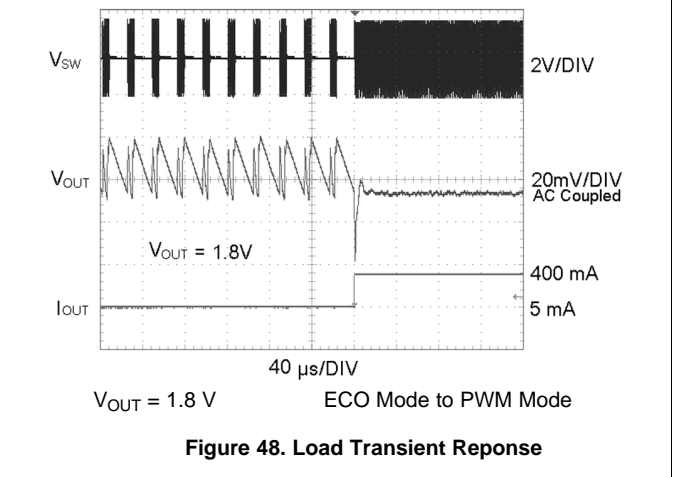
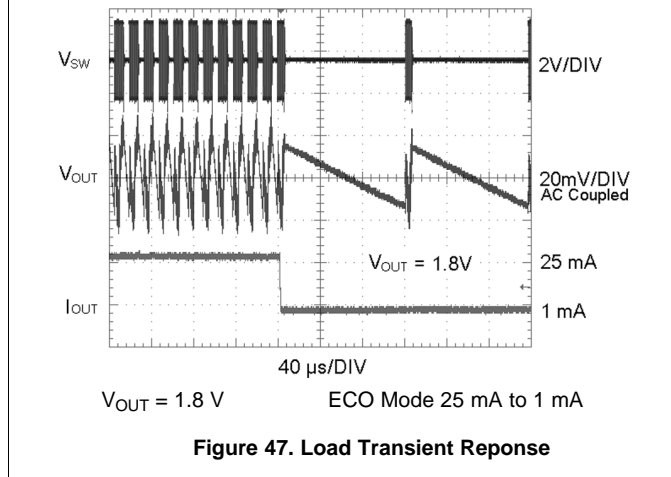
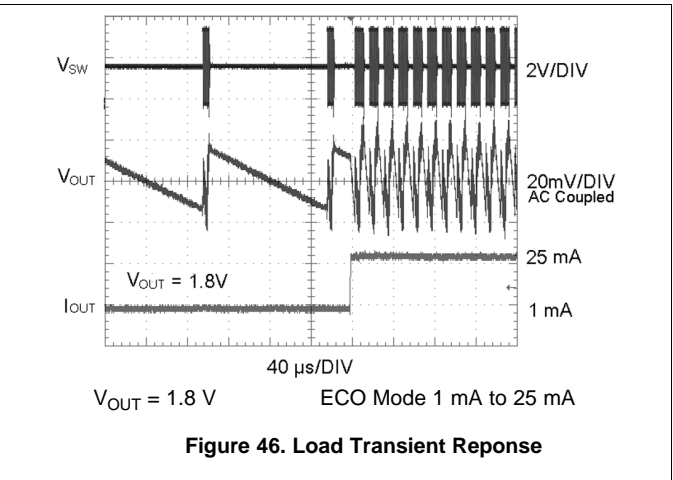
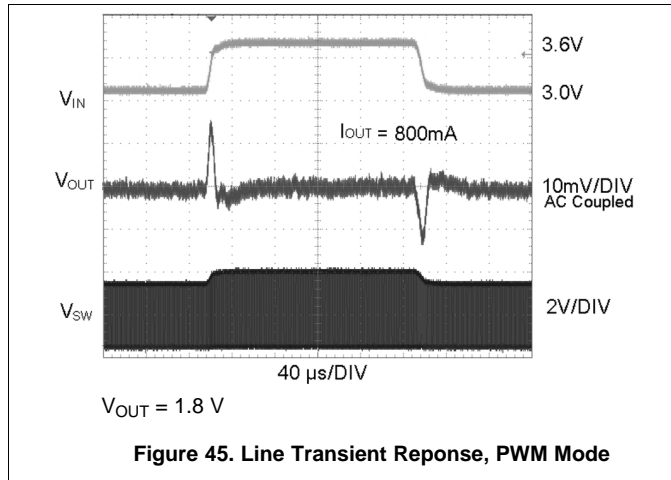

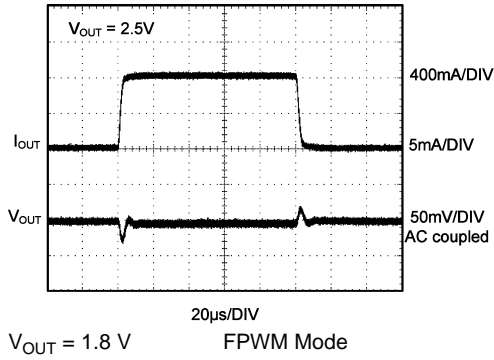
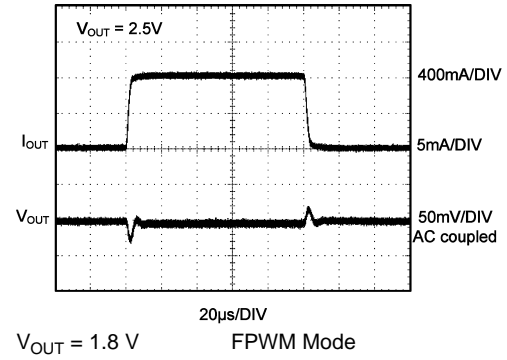
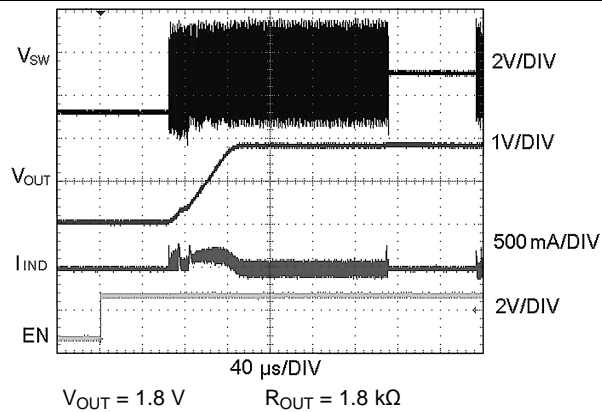
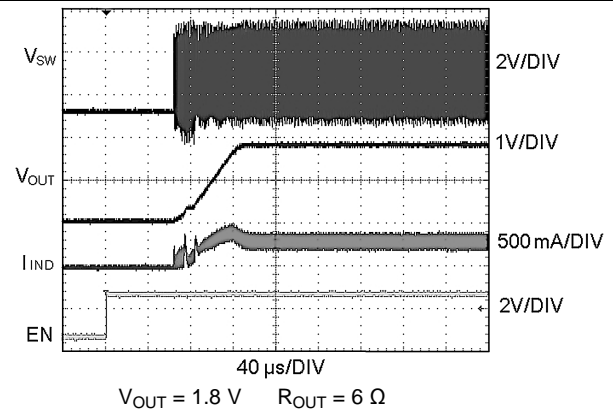
Figure 49. Load Transient Response

Figure 50. Load Transient Response

Figure 51. Start-Up Into ECO Mode

Figure 52. Start-Up Into PWM Mode

10 Power Supply Recommendations

The LM3671 is designed to operate from a stable input supply range of 2.3 V to 5.5 V.

11 Layout

11.1 Layout Guidelines

PC board layout is an important part of DC-DC converter design. Poor board layout can disrupt the performance of a DC-DC converter and surrounding circuitry by contributing to EMI, ground bounce, and resistive voltage loss in the traces. These can send erroneous signals to the DC-DC converter device, resulting in poor regulation or instability. In particular parasitic inductance from extra-long PCB trace lengths can cause additional noise voltages through $L \times di/dt$ that adversely affect the DC-DC converter device circuitry. Good layout for the LM3691 can be implemented by following a few simple design rules.

1. Place the inductor and filter capacitors close together and make the traces short. The traces between these components carry relatively high switching currents and act as antennas. Following this rule reduces radiated noise.
2. Place the capacitors and inductor close to the LM3691. Place the C_{IN} capacitor as close to the VIN and GND pads as possible. Place the C_{OUT} capacitor as close to the VOUT and GND connections as possible.
3. Arrange the components so that the switching current loops curl in the same direction. During the first half of each cycle, current flows from the input filter capacitor, through the buck and inductor to the output filter capacitor and back through ground, forming a current loop. In the second half of each cycle, current is pulled up from ground, through the buck by the inductor, to the output filter capacitor and then back through ground, forming a second current loop. Routing these loops so the current curls in the same direction prevents magnetic field reversal between the two half-cycles and reduces radiated noise.
4. Connect the ground pins of the buck and filter capacitors together using generous component-side copper fill as a pseudo-ground plane. Connect this to the ground-plane (if one is used) with several vias. This reduces ground-plane noise by preventing the switching currents from circulating through the ground plane. It also reduces ground bounce at the buck by giving it a low-impedance ground connection.
5. Use wide traces between the power components and for power connections to the DC-DC converter circuit. This reduces voltage errors by resistive losses across the traces. Even 1 mm of fine trace creates parasitic inductance that can undesirably affect performance from increased $L \times di/dt$ noise voltages.
6. Route noise sensitive traces, such as the voltage feedback path, away from noisy traces between the power components. The voltage feedback trace must remain close to the buck circuit, must be routed directly from FB to VOUT at the output capacitor, and must be routed opposite to noise components. This reduces EMI radiated onto the voltage feedback trace of the DC-DC converter.

11.2 Layout Example

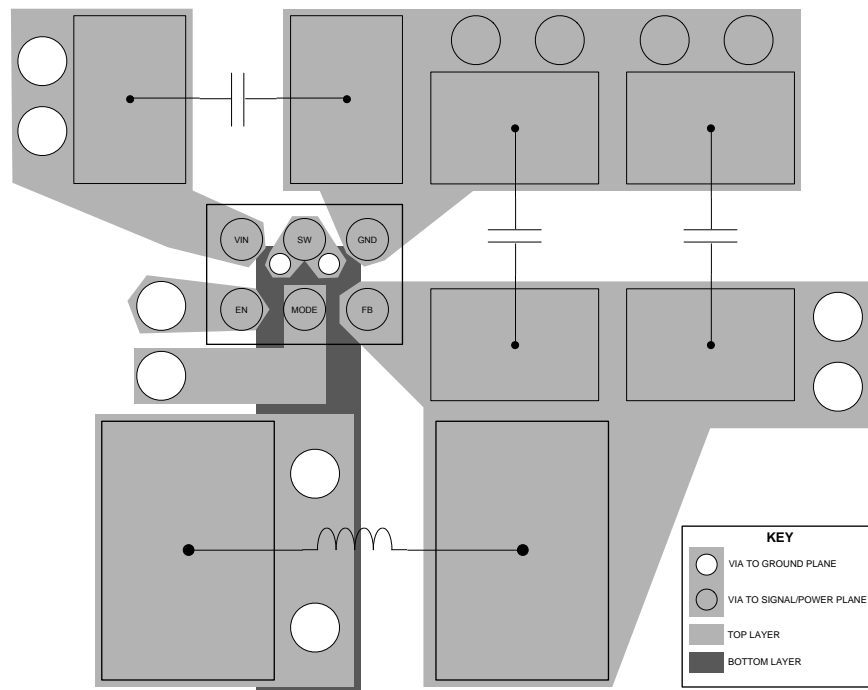

Figure 53. LM3291 Layout Example

11.3 DSBGA Package Assembly and Use

Use of the DSBGA package requires specialized board layout, precision mounting, and careful re-flow techniques, as detailed in TI Application Note *DSBGA Wafer Level Chip Scale Package* (SNVA009). Refer to the section *Surface Mount Assembly Considerations*. For best results in assembly, alignment ordinals on the PC board must be used to facilitate placement of the device. The pad style used with DSBGA package must be the NSMD (non-solder mask defined) type. This means that the solder-mask opening is larger than the pad size. This prevents a lip that otherwise forms if the solder-mask and pad overlap, from holding the device off the surface of the board and interfering with mounting. See SNVA009 for specific instructions how to do this.

The 6-pin package used for LM3691 has 300-micron solder balls and requires 10.82 mils pads for mounting on the circuit board. The trace to each pad must enter the pad with a 90° entry angle to prevent debris from being caught in deep corners. Initially, the trace to each pad must be 7-mil wide, for a section approximately 7-mil long or longer, as a thermal relief. Then each trace must neck up or down to its optimal width. The important criteria is symmetry. This ensures the solder bumps on the LM3691 re-flow evenly and that the device solders level to the board. In particular, special attention must be paid to the pads for bumps A2 and C2, because GND and V_{IN} are typically connected to large copper planes.

The DSBGA package is optimized for the smallest possible size in applications with red or infrared opaque cases. Because the DSBGA package lacks the plastic encapsulation characteristic of larger devices, it is vulnerable to light. Backside metallization and/or epoxy coating, along with front side shading by the printed circuit board, reduce this sensitivity. However, the package has exposed die edges. In particular, DSBGA devices are sensitive to light, in the red and infrared range, shining on the exposed die edges of the package.

12 Device and Documentation Support

12.1 Device Support

12.1.1 Third-Party Products Disclaimer

TI'S PUBLICATION OF INFORMATION REGARDING THIRD-PARTY PRODUCTS OR SERVICES DOES NOT CONSTITUTE AN ENDORSEMENT REGARDING THE SUITABILITY OF SUCH PRODUCTS OR SERVICES OR A WARRANTY, REPRESENTATION OR ENDORSEMENT OF SUCH PRODUCTS OR SERVICES, EITHER ALONE OR IN COMBINATION WITH ANY TI PRODUCT OR SERVICE.

12.2 Documentation Support

12.2.1 Related Documentation

For additional information, see the following:

TI Application Note *DSBGA Wafer Level Chip Scale Package* ([SNVA009](#))

12.3 Community Resources

The following links connect to TI community resources. Linked contents are provided "AS IS" by the respective contributors. They do not constitute TI specifications and do not necessarily reflect TI's views; see TI's [Terms of Use](#).

TI E2E™ Online Community *TI's Engineer-to-Engineer (E2E) Community*. Created to foster collaboration among engineers. At [e2e.ti.com](#), you can ask questions, share knowledge, explore ideas and help solve problems with fellow engineers.

Design Support *TI's Design Support* Quickly find helpful E2E forums along with design support tools and contact information for technical support.

12.4 Trademarks

E2E is a trademark of Texas Instruments.
All other trademarks are the property of their respective owners.

12.5 Electrostatic Discharge Caution



This integrated circuit can be damaged by ESD. Texas Instruments recommends that all integrated circuits be handled with appropriate precautions. Failure to observe proper handling and installation procedures can cause damage.

ESD damage can range from subtle performance degradation to complete device failure. Precision integrated circuits may be more susceptible to damage because very small parametric changes could cause the device not to meet its published specifications.

12.6 Glossary

[SLYZ022](#) — *TI Glossary*.

This glossary lists and explains terms, acronyms, and definitions.

13 Mechanical, Packaging, and Orderable Information

The following pages include mechanical, packaging, and orderable information. This information is the most current data available for the designated devices. This data is subject to change without notice and revision of this document. For browser-based versions of this data sheet, refer to the left-hand navigation.

PACKAGING INFORMATION

Orderable Device	Status (1)	Package Type	Package Drawing	Pins	Package Qty	Eco Plan (2)	Lead/Ball Finish (6)	MSL Peak Temp (3)	Op Temp (°C)	Device Marking (4/5)	Samples
LM3691TL-0.75/NOPB	ACTIVE	DSBGA	YZR	6	250	Green (RoHS & no Sb/Br)	SNAGCU	Level-1-260C-UNLIM	-30 to 85	V	Samples
LM3691TL-1.0/NOPB	ACTIVE	DSBGA	YZR	6	250	Green (RoHS & no Sb/Br)	SNAGCU	Level-1-260C-UNLIM		F	Samples
LM3691TL-1.2/NOPB	ACTIVE	DSBGA	YZR	6	250	Green (RoHS & no Sb/Br)	SNAGCU	Level-1-260C-UNLIM	-30 to 85	X	Samples
LM3691TL-1.5/NOPB	ACTIVE	DSBGA	YZR	6	250	Green (RoHS & no Sb/Br)	SNAGCU	Level-1-260C-UNLIM	-30 to 85	Y	Samples
LM3691TL-1.8/NOPB	ACTIVE	DSBGA	YZR	6	250	Green (RoHS & no Sb/Br)	SNAGCU	Level-1-260C-UNLIM	-30 to 85	Z	Samples
LM3691TL-2.5/NOPB	ACTIVE	DSBGA	YZR	6	250	Green (RoHS & no Sb/Br)	SNAGCU	Level-1-260C-UNLIM		8	Samples
LM3691TL-3.3/NOPB	ACTIVE	DSBGA	YZR	6	250	Green (RoHS & no Sb/Br)	SNAGCU	Level-1-260C-UNLIM		T	Samples
LM3691TLX-1.0/NOPB	ACTIVE	DSBGA	YZR	6	3000	Green (RoHS & no Sb/Br)	SNAGCU	Level-1-260C-UNLIM		F	Samples
LM3691TLX-1.2/NOPB	ACTIVE	DSBGA	YZR	6	3000	Green (RoHS & no Sb/Br)	SNAGCU	Level-1-260C-UNLIM	-30 to 85	X	Samples
LM3691TLX-1.5/NOPB	ACTIVE	DSBGA	YZR	6	3000	Green (RoHS & no Sb/Br)	SNAGCU	Level-1-260C-UNLIM	-30 to 85	Y	Samples
LM3691TLX-1.8/NOPB	ACTIVE	DSBGA	YZR	6	3000	Green (RoHS & no Sb/Br)	SNAGCU	Level-1-260C-UNLIM	-30 to 85	Z	Samples
LM3691TLX-2.5/NOPB	ACTIVE	DSBGA	YZR	6	3000	Green (RoHS & no Sb/Br)	SNAGCU	Level-1-260C-UNLIM		8	Samples
LM3691TLX-3.3/NOPB	ACTIVE	DSBGA	YZR	6	3000	Green (RoHS & no Sb/Br)	SNAGCU	Level-1-260C-UNLIM		T	Samples

(1) The marketing status values are defined as follows:

ACTIVE: Product device recommended for new designs.

LIFEBUY: TI has announced that the device will be discontinued, and a lifetime-buy period is in effect.

NRND: Not recommended for new designs. Device is in production to support existing customers, but TI does not recommend using this part in a new design.

PREVIEW: Device has been announced but is not in production. Samples may or may not be available.

OBSOLETE: TI has discontinued the production of the device.

⁽²⁾ Eco Plan - The planned eco-friendly classification: Pb-Free (RoHS), Pb-Free (RoHS Exempt), or Green (RoHS & no Sb/Br) - please check <http://www.ti.com/productcontent> for the latest availability information and additional product content details.

TBD: The Pb-Free/Green conversion plan has not been defined.

Pb-Free (RoHS): TI's terms "Lead-Free" or "Pb-Free" mean semiconductor products that are compatible with the current RoHS requirements for all 6 substances, including the requirement that lead not exceed 0.1% by weight in homogeneous materials. Where designed to be soldered at high temperatures, TI Pb-Free products are suitable for use in specified lead-free processes.

Pb-Free (RoHS Exempt): This component has a RoHS exemption for either 1) lead-based flip-chip solder bumps used between the die and package, or 2) lead-based die adhesive used between the die and leadframe. The component is otherwise considered Pb-Free (RoHS compatible) as defined above.

Green (RoHS & no Sb/Br): TI defines "Green" to mean Pb-Free (RoHS compatible), and free of Bromine (Br) and Antimony (Sb) based flame retardants (Br or Sb do not exceed 0.1% by weight in homogeneous material)

⁽³⁾ MSL, Peak Temp. - The Moisture Sensitivity Level rating according to the JEDEC industry standard classifications, and peak solder temperature.

⁽⁴⁾ There may be additional marking, which relates to the logo, the lot trace code information, or the environmental category on the device.

⁽⁵⁾ Multiple Device Markings will be inside parentheses. Only one Device Marking contained in parentheses and separated by a "~" will appear on a device. If a line is indented then it is a continuation of the previous line and the two combined represent the entire Device Marking for that device.

⁽⁶⁾ Lead/Ball Finish - Orderable Devices may have multiple material finish options. Finish options are separated by a vertical ruled line. Lead/Ball Finish values may wrap to two lines if the finish value exceeds the maximum column width.

Important Information and Disclaimer: The information provided on this page represents TI's knowledge and belief as of the date that it is provided. TI bases its knowledge and belief on information provided by third parties, and makes no representation or warranty as to the accuracy of such information. Efforts are underway to better integrate information from third parties. TI has taken and continues to take reasonable steps to provide representative and accurate information but may not have conducted destructive testing or chemical analysis on incoming materials and chemicals. TI and TI suppliers consider certain information to be proprietary, and thus CAS numbers and other limited information may not be available for release.

In no event shall TI's liability arising out of such information exceed the total purchase price of the TI part(s) at issue in this document sold by TI to Customer on an annual basis.

TAPE AND REEL INFORMATION



QUADRANT ASSIGNMENTS FOR PIN 1 ORIENTATION IN TAPE



*All dimensions are nominal

Device	Package Type	Package Drawing	Pins	SPQ	Reel Diameter (mm)	Reel Width W1 (mm)	A0 (mm)	B0 (mm)	K0 (mm)	P1 (mm)	W (mm)	Pin1 Quadrant
LM3691TL-0.75/NOPB	DSBGA	YZR	6	250	178.0	8.4	1.35	1.75	0.76	4.0	8.0	Q1
LM3691TL-1.0/NOPB	DSBGA	YZR	6	250	178.0	8.4	1.35	1.75	0.76	4.0	8.0	Q1
LM3691TL-1.2/NOPB	DSBGA	YZR	6	250	178.0	8.4	1.35	1.75	0.76	4.0	8.0	Q1
LM3691TL-1.5/NOPB	DSBGA	YZR	6	250	178.0	8.4	1.35	1.75	0.76	4.0	8.0	Q1
LM3691TL-1.8/NOPB	DSBGA	YZR	6	250	178.0	8.4	1.35	1.75	0.76	4.0	8.0	Q1
LM3691TL-2.5/NOPB	DSBGA	YZR	6	250	178.0	8.4	1.35	1.75	0.76	4.0	8.0	Q1
LM3691TL-3.3/NOPB	DSBGA	YZR	6	250	178.0	8.4	1.35	1.75	0.76	4.0	8.0	Q1
LM3691TLX-1.0/NOPB	DSBGA	YZR	6	3000	178.0	8.4	1.35	1.75	0.76	4.0	8.0	Q1
LM3691TLX-1.2/NOPB	DSBGA	YZR	6	3000	178.0	8.4	1.35	1.75	0.76	4.0	8.0	Q1
LM3691TLX-1.5/NOPB	DSBGA	YZR	6	3000	178.0	8.4	1.35	1.75	0.76	4.0	8.0	Q1
LM3691TLX-1.8/NOPB	DSBGA	YZR	6	3000	178.0	8.4	1.35	1.75	0.76	4.0	8.0	Q1
LM3691TLX-2.5/NOPB	DSBGA	YZR	6	3000	178.0	8.4	1.35	1.75	0.76	4.0	8.0	Q1
LM3691TLX-3.3/NOPB	DSBGA	YZR	6	3000	178.0	8.4	1.35	1.75	0.76	4.0	8.0	Q1

TAPE AND REEL BOX DIMENSIONS

*All dimensions are nominal

Device	Package Type	Package Drawing	Pins	SPQ	Length (mm)	Width (mm)	Height (mm)
LM3691TL-0.75/NOPB	DSBGA	YZR	6	250	210.0	185.0	35.0
LM3691TL-1.0/NOPB	DSBGA	YZR	6	250	210.0	185.0	35.0
LM3691TL-1.2/NOPB	DSBGA	YZR	6	250	210.0	185.0	35.0
LM3691TL-1.5/NOPB	DSBGA	YZR	6	250	210.0	185.0	35.0
LM3691TL-1.8/NOPB	DSBGA	YZR	6	250	210.0	185.0	35.0
LM3691TL-2.5/NOPB	DSBGA	YZR	6	250	210.0	185.0	35.0
LM3691TL-3.3/NOPB	DSBGA	YZR	6	250	210.0	185.0	35.0
LM3691TLX-1.0/NOPB	DSBGA	YZR	6	3000	210.0	185.0	35.0
LM3691TLX-1.2/NOPB	DSBGA	YZR	6	3000	210.0	185.0	35.0
LM3691TLX-1.5/NOPB	DSBGA	YZR	6	3000	210.0	185.0	35.0
LM3691TLX-1.8/NOPB	DSBGA	YZR	6	3000	210.0	185.0	35.0
LM3691TLX-2.5/NOPB	DSBGA	YZR	6	3000	210.0	185.0	35.0
LM3691TLX-3.3/NOPB	DSBGA	YZR	6	3000	210.0	185.0	35.0

YZR0006

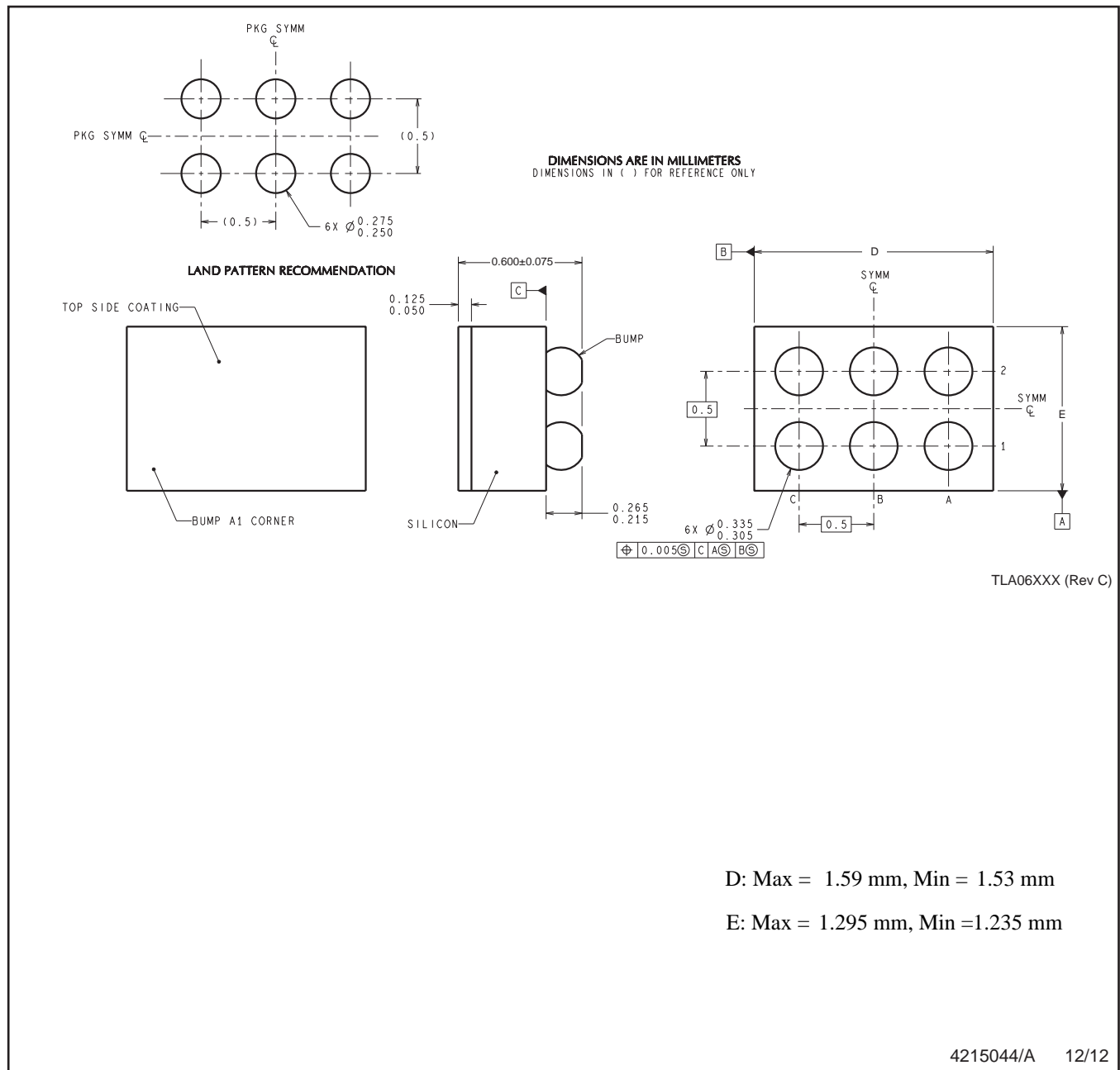

NOTES: A. All linear dimensions are in millimeters. Dimensioning and tolerancing per ASME Y14.5M-1994.
B. This drawing is subject to change without notice.

IMPORTANT NOTICE

Texas Instruments Incorporated and its subsidiaries (TI) reserve the right to make corrections, enhancements, improvements and other changes to its semiconductor products and services per JESD46, latest issue, and to discontinue any product or service per JESD48, latest issue. Buyers should obtain the latest relevant information before placing orders and should verify that such information is current and complete. All semiconductor products (also referred to herein as "components") are sold subject to TI's terms and conditions of sale supplied at the time of order acknowledgment.

TI warrants performance of its components to the specifications applicable at the time of sale, in accordance with the warranty in TI's terms and conditions of sale of semiconductor products. Testing and other quality control techniques are used to the extent TI deems necessary to support this warranty. Except where mandated by applicable law, testing of all parameters of each component is not necessarily performed.

TI assumes no liability for applications assistance or the design of Buyers' products. Buyers are responsible for their products and applications using TI components. To minimize the risks associated with Buyers' products and applications, Buyers should provide adequate design and operating safeguards.

TI does not warrant or represent that any license, either express or implied, is granted under any patent right, copyright, mask work right, or other intellectual property right relating to any combination, machine, or process in which TI components or services are used. Information published by TI regarding third-party products or services does not constitute a license to use such products or services or a warranty or endorsement thereof. Use of such information may require a license from a third party under the patents or other intellectual property of the third party, or a license from TI under the patents or other intellectual property of TI.

Reproduction of significant portions of TI information in TI data books or data sheets is permissible only if reproduction is without alteration and is accompanied by all associated warranties, conditions, limitations, and notices. TI is not responsible or liable for such altered documentation. Information of third parties may be subject to additional restrictions.

Resale of TI components or services with statements different from or beyond the parameters stated by TI for that component or service voids all express and any implied warranties for the associated TI component or service and is an unfair and deceptive business practice. TI is not responsible or liable for any such statements.

Buyer acknowledges and agrees that it is solely responsible for compliance with all legal, regulatory and safety-related requirements concerning its products, and any use of TI components in its applications, notwithstanding any applications-related information or support that may be provided by TI. Buyer represents and agrees that it has all the necessary expertise to create and implement safeguards which anticipate dangerous consequences of failures, monitor failures and their consequences, lessen the likelihood of failures that might cause harm and take appropriate remedial actions. Buyer will fully indemnify TI and its representatives against any damages arising out of the use of any TI components in safety-critical applications.

In some cases, TI components may be promoted specifically to facilitate safety-related applications. With such components, TI's goal is to help enable customers to design and create their own end-product solutions that meet applicable functional safety standards and requirements. Nonetheless, such components are subject to these terms.

No TI components are authorized for use in FDA Class III (or similar life-critical medical equipment) unless authorized officers of the parties have executed a special agreement specifically governing such use.

Only those TI components which TI has specifically designated as military grade or "enhanced plastic" are designed and intended for use in military/aerospace applications or environments. Buyer acknowledges and agrees that any military or aerospace use of TI components which have **not** been so designated is solely at the Buyer's risk, and that Buyer is solely responsible for compliance with all legal and regulatory requirements in connection with such use.

TI has specifically designated certain components as meeting ISO/TS16949 requirements, mainly for automotive use. In any case of use of non-designated products, TI will not be responsible for any failure to meet ISO/TS16949.

Products

Audio	www.ti.com/audio
Amplifiers	amplifier.ti.com
Data Converters	dataconverter.ti.com
DLP® Products	www.dlp.com
DSP	dsp.ti.com
Clocks and Timers	www.ti.com/clocks
Interface	interface.ti.com
Logic	logic.ti.com
Power Mgmt	power.ti.com
Microcontrollers	microcontroller.ti.com
RFID	www.ti-rfid.com
OMAP Applications Processors	www.ti.com/omap
Wireless Connectivity	www.ti.com/wirelessconnectivity

Applications

Automotive and Transportation	www.ti.com/automotive
Communications and Telecom	www.ti.com/communications
Computers and Peripherals	www.ti.com/computers
Consumer Electronics	www.ti.com/consumer-apps
Energy and Lighting	www.ti.com/energy
Industrial	www.ti.com/industrial
Medical	www.ti.com/medical
Security	www.ti.com/security
Space, Avionics and Defense	www.ti.com/space-avionics-defense
Video and Imaging	www.ti.com/video

TI E2E Community

e2e.ti.com