

IP4283CZ10 series

ESD protection for ultra high-speed interfaces

Rev. 4 — 8 April 2013

Product data sheet

1. Product profile

1.1 General description

The devices are designed to protect high-speed interfaces such as High-Definition Multimedia Interface (HDMI), DisplayPort, external Serial Advanced Technology Attachment (eSATA) and Low-Voltage Differential Signaling (LVDS) interfaces against ElectroStatic Discharge (ESD).

The devices include four high-level ESD protection diode structures for ultra high-speed signal lines. They are available in three package variants: DFN2510-10 (SOT1165-1), DFN2510A-10 (SOT1176-1) and TSSOP10 (SOT552-1).

All signal lines are protected by a special diode configuration offering ultra low line capacitance of only 0.6 pF. These diodes provide protection to downstream components from ESD voltages up to ± 8 kV contact according to IEC 61000-4-2, level 4.

1.2 Features and benefits

- System ESD protection for HDMI, DisplayPort, eSATA and LVDS
- All signal lines with integrated rail-to-rail clamping diodes for downstream ESD protection of ± 8 kV according to IEC 61000-4-2, level 4
- Matched 0.5 mm trace spacing
- Signal lines with ≤ 0.05 pF matching capacitance between signal pairs
- Line capacitance of only 0.6 pF for each channel
- Design-friendly 'pass-thru' signal routing

1.3 Applications

The devices are designed for high-speed receiver and transmitter port protection:

- TVs, monitors
- DVD recorders and players
- Notebooks, main board graphics cards and ports
- Set-top boxes and game consoles

2. Pinning information

Table 1. Pinning

| Pin | Symbol | Description | Simplified outline | Graphic symbol |
|-----------------------------------|-----------|-----------------------------------|---|--|
| IP4283CZ10-TBA (SOT1165-1) | | | | |
| 1 | TMDS_CH1- | negative channel 1 ESD protection |  <p>Transparent top view DFN2510-10</p> |  <p>001aai619</p> |
| 2 | TMDS_CH1+ | positive channel 1 ESD protection | | |
| 3 | GND | ground | | |
| 4 | TMDS_CH2- | negative channel 2 ESD protection | | |
| 5 | TMDS_CH2+ | positive channel 2 ESD protection | | |
| 6 | n.c. | not connected | | |
| 7 | n.c. | not connected | | |
| 8 | GND | ground | | |
| 9 | n.c. | not connected | | |
| 10 | n.c. | not connected | | |
| IP4283CZ10-TBR (SOT1176-1) | | | | |
| 1 | TMDS_CH1- | negative channel 1 ESD protection |  <p>Transparent top view DFN2510A-10</p> |  <p>001aai619</p> |
| 2 | TMDS_CH1+ | positive channel 1 ESD protection | | |
| 3 | GND | ground | | |
| 4 | TMDS_CH2- | negative channel 2 ESD protection | | |
| 5 | TMDS_CH2+ | positive channel 2 ESD protection | | |
| 6 | n.c. | not connected | | |
| 7 | n.c. | not connected | | |
| 8 | GND | ground | | |
| 9 | n.c. | not connected | | |
| 10 | n.c. | not connected | | |

Table 1. Pinning ...continued

| Pin | Symbol | Description | Simplified outline | Graphic symbol |
|---------------------------------|-----------|-----------------------------------|--|--|
| IP4283CZ10-TT (SOT552-1) | | | | |
| 1 | TMDS_CH1- | negative channel 1 ESD protection |  <p style="text-align: center;">TSSOP10</p> |  <p style="text-align: center;">001aai619</p> |
| 2 | TMDS_CH1+ | positive channel 1 ESD protection | | |
| 3 | GND | ground | | |
| 4 | TMDS_CH2- | negative channel 2 ESD protection | | |
| 5 | TMDS_CH2+ | positive channel 2 ESD protection | | |
| 6 | n.c. | not connected | | |
| 7 | n.c. | not connected | | |
| 8 | GND | ground | | |
| 9 | n.c. | not connected | | |
| 10 | n.c. | not connected | | |

3. Ordering information

Table 2. Ordering information

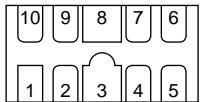
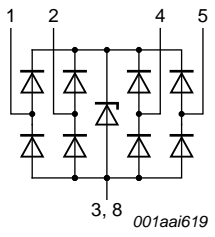
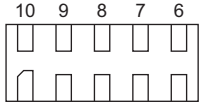
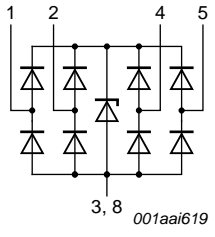
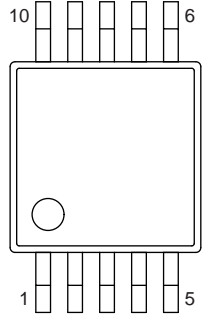
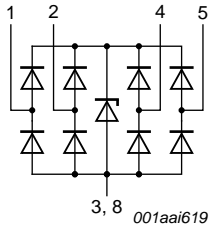
| Type number | Package | | |
|----------------|-------------|---|-----------|
| | Name | Description | Version |
| IP4283CZ10-TBA | DFN2510-10 | plastic extremely thin small outline package; no leads; 10 terminals; body 1 × 2.5 × 0.5 mm | SOT1165-1 |
| IP4283CZ10-TBR | DFN2510A-10 | plastic extremely thin small outline package; no leads; 10 terminals; body 1 × 2.5 × 0.5 mm | SOT1176-1 |
| IP4283CZ10-TT | TSSOP10 | plastic thin shrink small outline package; 10 leads; body width 3 mm | SOT552-1 |

4. Marking

Table 3. Marking codes

| Type number | Marking code |
|----------------|--------------|
| IP4283CZ10-TBA | 83 |
| IP4283CZ10-TBR | 83 |
| IP4283CZ10-TT | 4283 |

5. Limiting values

Table 4. Limiting values

In accordance with the Absolute Maximum Rating System (IEC 60134).

| Symbol | Parameter | Conditions | Min | Max | Unit |
|-----------|---------------------------------|--|------|------|------|
| V_I | input voltage | | -0.5 | +5.5 | V |
| V_{ESD} | electrostatic discharge voltage | IEC 61000-4-2, level 4 [1] | | | |
| | | contact discharge | -8 | +8 | kV |
| | | air discharge | -15 | +15 | kV |
| T_{stg} | storage temperature | | -55 | +125 | °C |
| T_{amb} | ambient temperature | | -40 | +85 | °C |

[1] All pins to ground.

6. Characteristics

Table 5. Characteristics

$T_{amb} = 25\text{ °C}$ unless otherwise specified.

| Symbol | Parameter | Conditions | Min | Typ | Max | Unit |
|--------------------|-----------------------------|---|------------------------|------|------|---------------|
| V_{BR} | breakdown voltage | $I_{test} = 1\text{ mA}$ | 6 | - | 9 | V |
| I_{LR} | reverse leakage current | per TMDS channel; $V = 3\text{ V}$ | - | - | 1 | μA |
| V_F | forward voltage | $I_{test} = 1\text{ mA}$ | - | 0.7 | - | V |
| C_{line} | line capacitance | $f = 1\text{ MHz}$; $V_{bias} = 2.5\text{ V}$ | [1] | - | 0.6 | pF |
| ΔC_{line} | line capacitance difference | $f = 1\text{ MHz}$; $V_{bias} = 2.5\text{ V}$ | [1] | - | 0.05 | pF |
| $C_{line(mutual)}$ | mutual line capacitance | $f = 1\text{ MHz}$; $V_{bias} = 2.5\text{ V}$ | [1][2] | - | 0.07 | pF |
| r_{dyn} | dynamic resistance | surge [3] | | | | |
| | | positive transient | - | 0.8 | - | Ω |
| | | negative transient | - | 0.85 | - | Ω |
| V_{CL} | clamping voltage | positive transient; $I_{PP} = 3.8\text{ A}$ | [3] | - | 9.5 | V |
| | | negative transient; $I_{PP} = -2.8\text{ A}$ | [3] | - | -3.2 | V |

[1] This parameter is guaranteed by design.

[2] Between signal pin and pin n.c.

[3] According to IEC 61000-4-5 (8/20 μs).

7. Application information

The devices are designed to provide high-level ESD protection for high-speed serial data buses such as HDMI, DisplayPort, eSATA and LVDS data lines.

When designing the Printed-Circuit Board (PCB), give careful consideration to impedance matching, and signal coupling.

Basic application diagrams for the ESD protection of an HDMI interface are shown in [Figure 1](#) and [2](#).

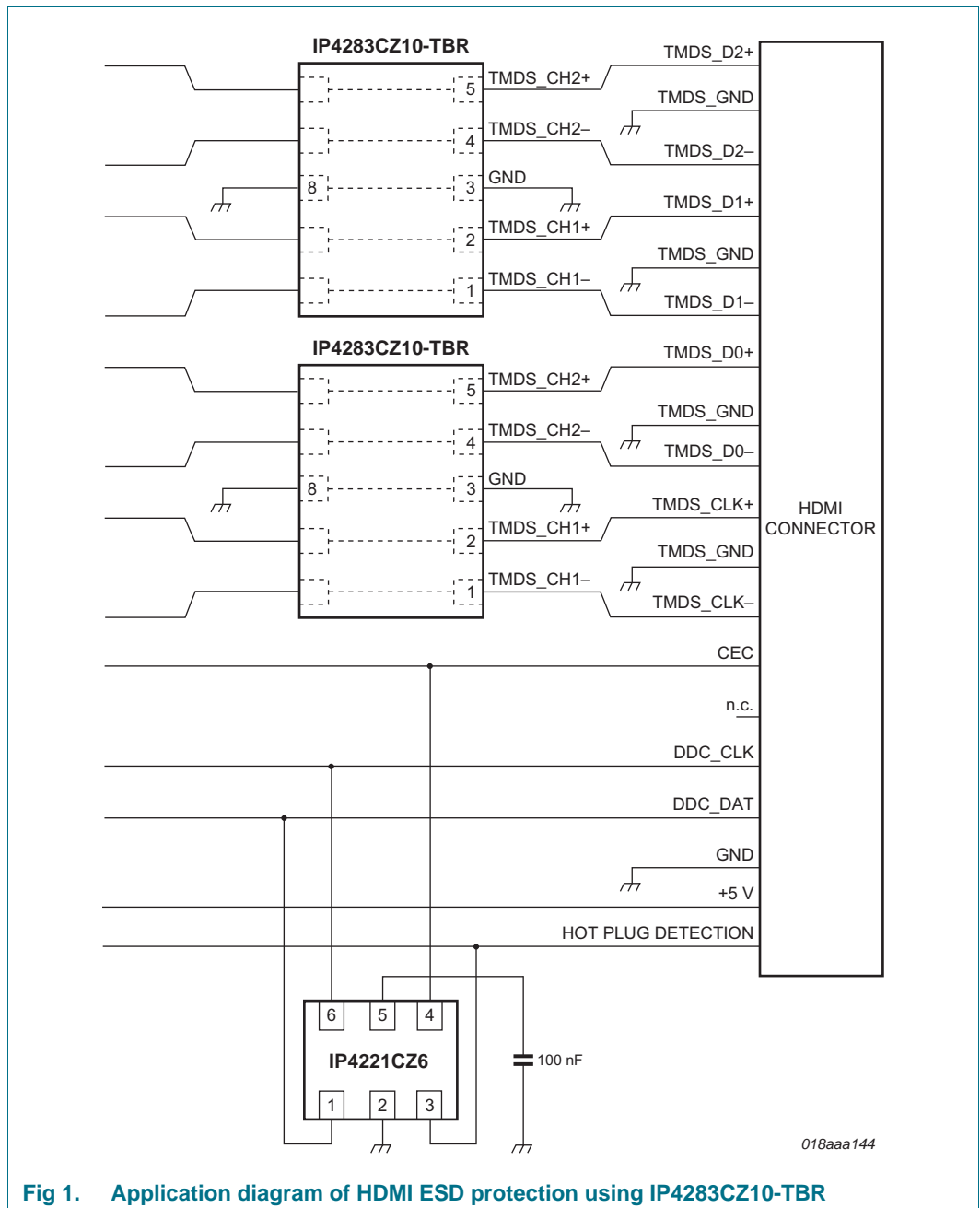

Fig 1. Application diagram of HDMI ESD protection using IP4283CZ10-TBR

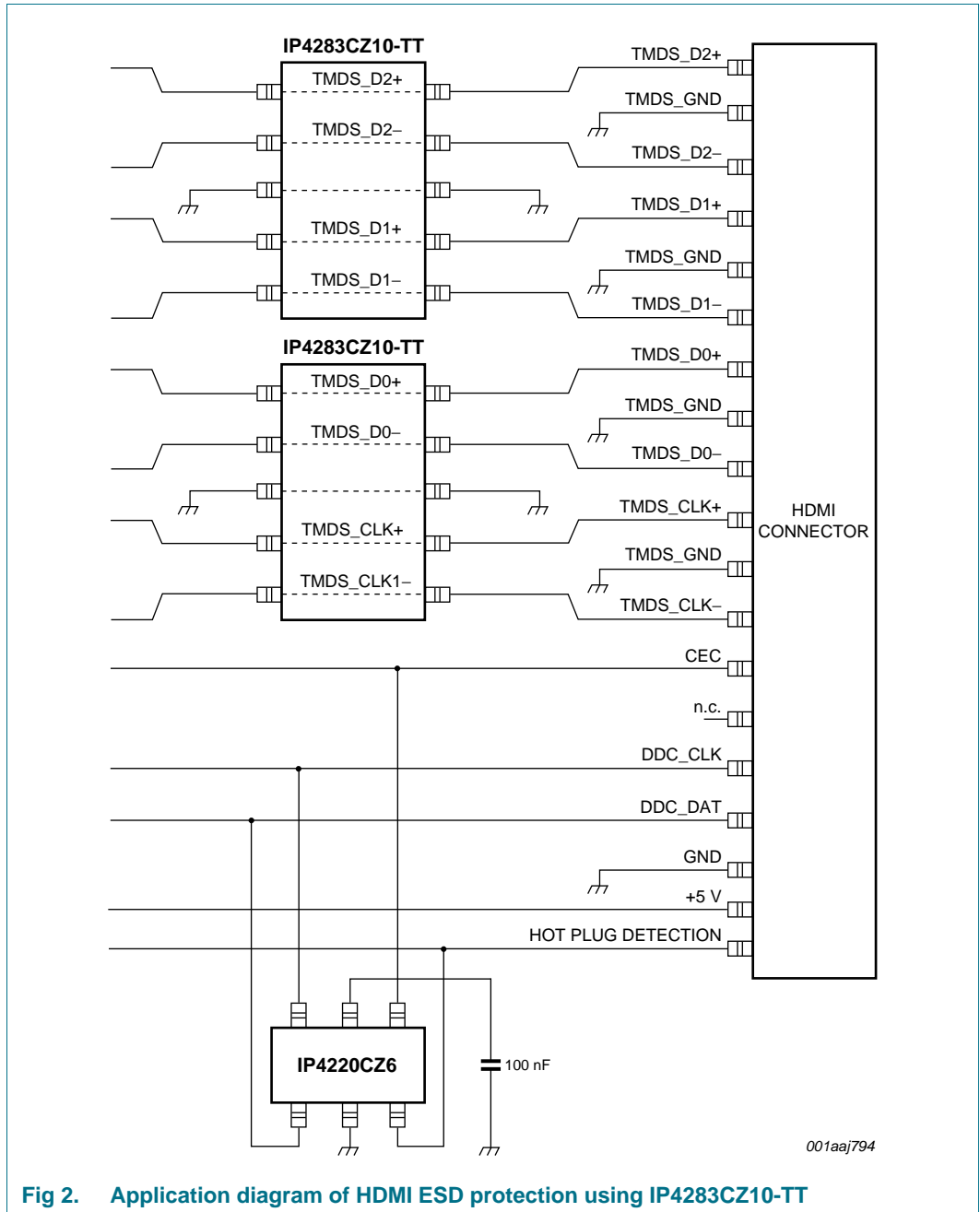

Fig 2. Application diagram of HDMI ESD protection using IP4283CZ10-TT

8. Package outline

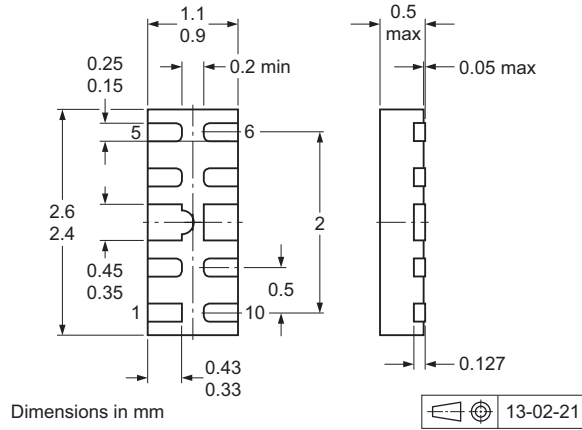

Fig 3. Package outline DFN2510-10 (SOT1165-1)

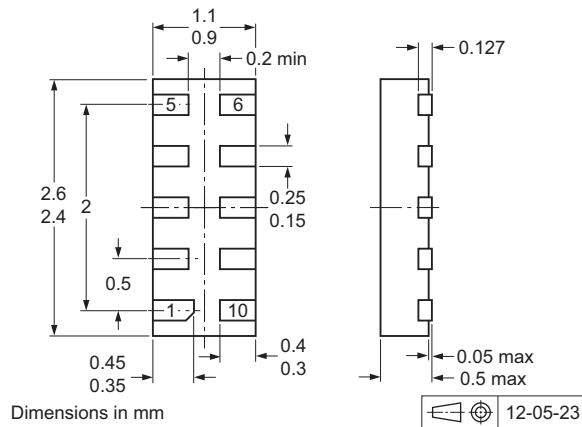

Fig 4. Package outline DFN2510A-10 (SOT1176-1)

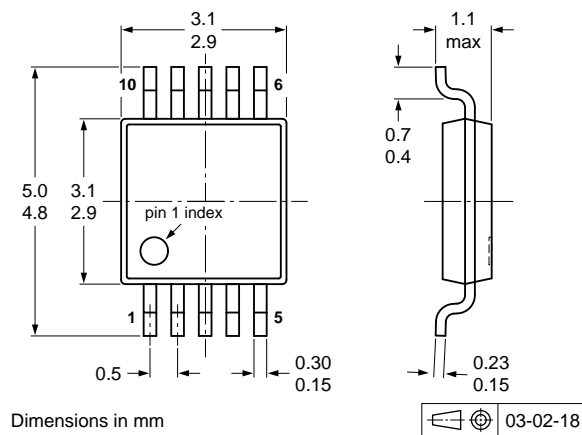

Fig 5. Package outline TSSOP10 (SOT552-1)

9. Soldering

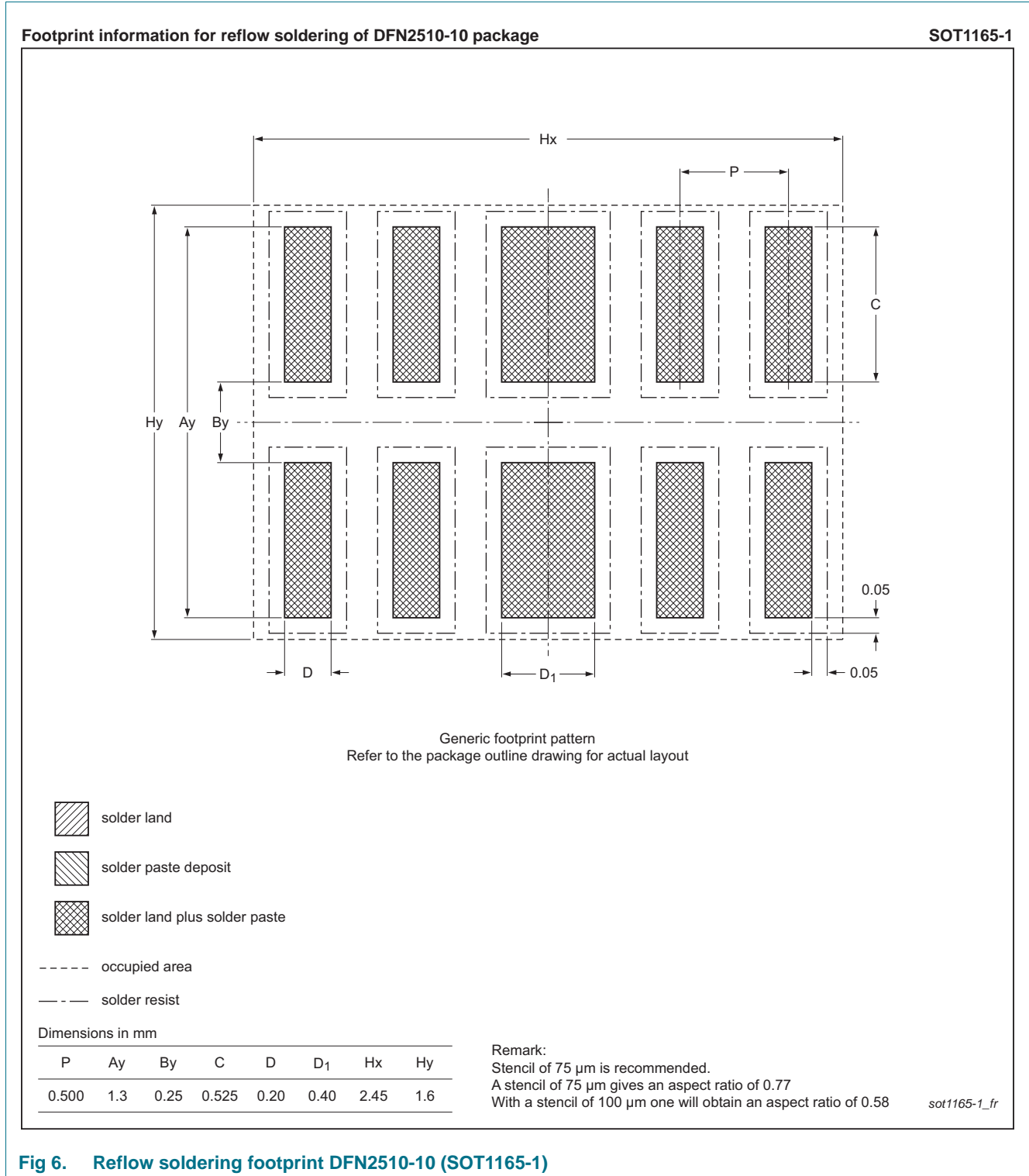

Fig 6. Reflow soldering footprint DFN2510-10 (SOT1165-1)

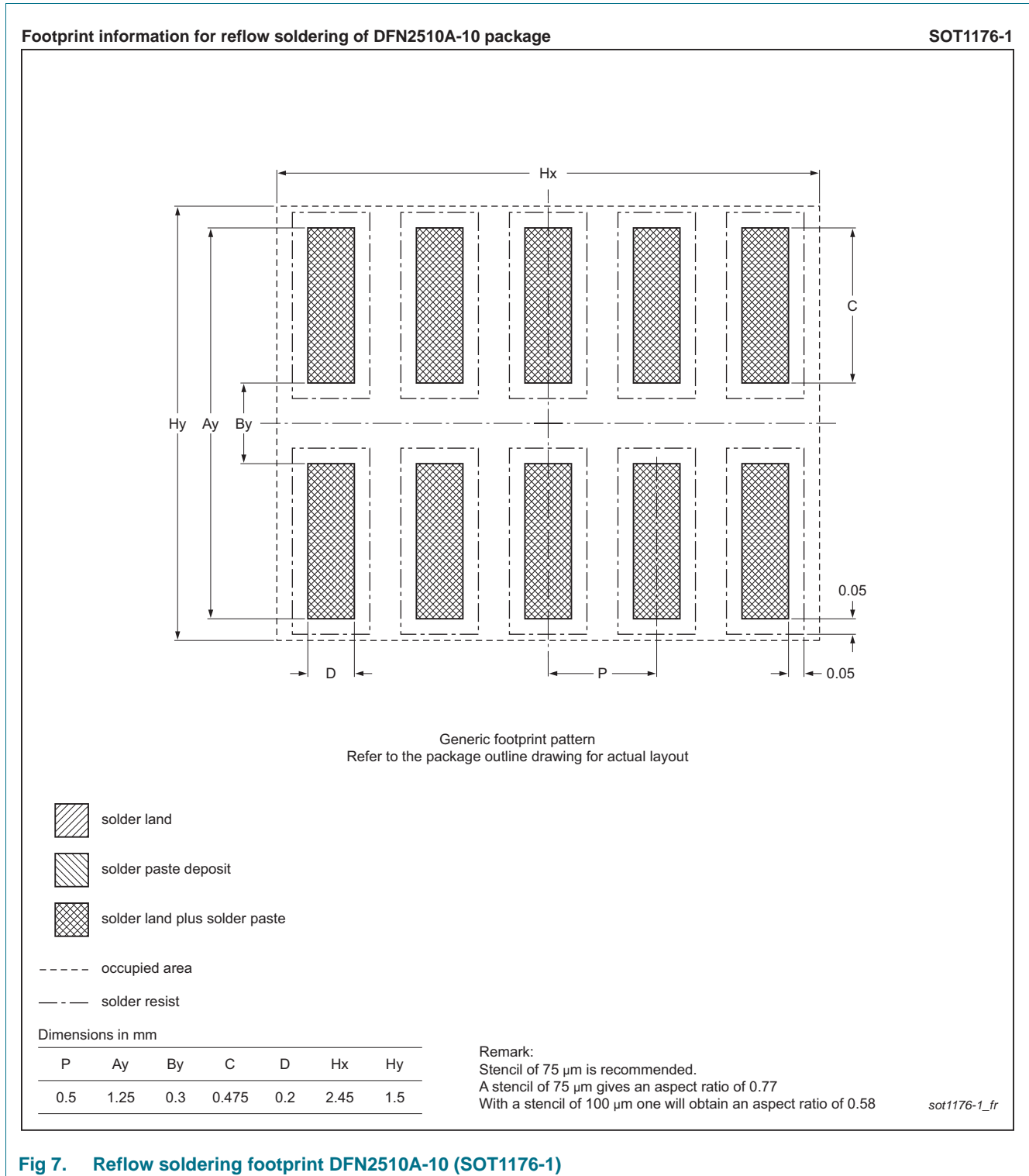

Fig 7. Reflow soldering footprint DFN2510A-10 (SOT1176-1)

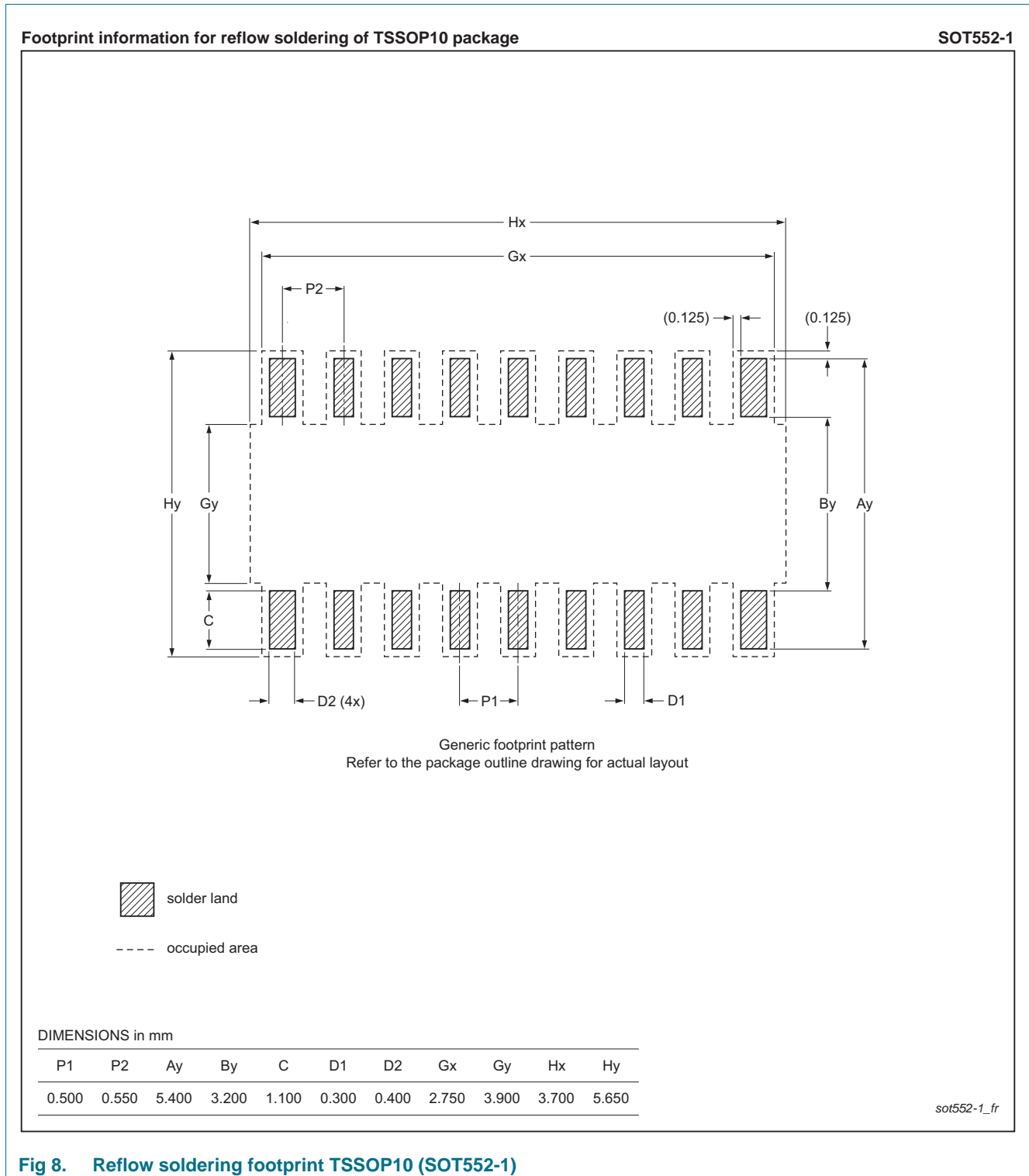

Fig 8. Reflow soldering footprint TSSOP10 (SOT552-1)

10. Revision history

Table 6. Revision history

| Document ID | Release date | Data sheet status | Change notice | Supersedes |
|--------------------|--|--------------------|---------------|--------------------|
| IP4283CZ10_SER v.4 | 20130408 | Product data sheet | - | IP4283CZ10_SER v.3 |
| Modifications: | <ul style="list-style-type: none"> • Section 1.1 “General description”: updated • Section 1.2 “Features and benefits”: updated • Section 2 “Pinning information”: updated • Section 3 “Ordering information”: updated • Table 5 “Characteristics”: updated; r_{dyn} value corrected • Section 8 “Package outline”: drawings replaced with minimized package outline drawings • Section 9 “Soldering”: updated • Section 11 “Legal information”: updated | | | |
| IP4283CZ10_SER v.3 | 20110624 | Product data sheet | - | IP4283CZ10_SER v.2 |
| IP4283CZ10_SER v.2 | 20100827 | Product data sheet | - | IP4283CZ10 v.1 |
| IP4283CZ10 v.1 | 20090507 | Product data sheet | - | - |

11. Legal information

11.1 Data sheet status

| Document status ^{[1][2]} | Product status ^[3] | Definition |
|-----------------------------------|-------------------------------|---|
| Objective [short] data sheet | Development | This document contains data from the objective specification for product development. |
| Preliminary [short] data sheet | Qualification | This document contains data from the preliminary specification. |
| Product [short] data sheet | Production | This document contains the product specification. |

[1] Please consult the most recently issued document before initiating or completing a design.

[2] The term 'short data sheet' is explained in section "Definitions".

[3] The product status of device(s) described in this document may have changed since this document was published and may differ in case of multiple devices. The latest product status information is available on the Internet at URL <http://www.nexperia.com>.

11.2 Definitions

Draft — The document is a draft version only. The content is still under internal review and subject to formal approval, which may result in modifications or additions. Nexperia does not give any representations or warranties as to the accuracy or completeness of information included herein and shall have no liability for the consequences of use of such information.

Short data sheet — A short data sheet is an extract from a full data sheet with the same product type number(s) and title. A short data sheet is intended for quick reference only and should not be relied upon to contain detailed and full information. For detailed and full information see the relevant full data sheet, which is available on request via the local Nexperia sales office. In case of any inconsistency or conflict with the short data sheet, the full data sheet shall prevail.

Product specification — The information and data provided in a Product data sheet shall define the specification of the product as agreed between Nexperia and its customer, unless Nexperia and customer have explicitly agreed otherwise in writing. In no event however, shall an agreement be valid in which the Nexperia product is deemed to offer functions and qualities beyond those described in the Product data sheet.

11.3 Disclaimers

Limited warranty and liability — Information in this document is believed to be accurate and reliable. However, Nexperia does not give any representations or warranties, expressed or implied, as to the accuracy or completeness of such information and shall have no liability for the consequences of use of such information. Nexperia takes no responsibility for the content in this document if provided by an information source outside of Nexperia.

In no event shall Nexperia be liable for any indirect, incidental, punitive, special or consequential damages (including - without limitation - lost profits, lost savings, business interruption, costs related to the removal or replacement of any products or rework charges) whether or not such damages are based on tort (including negligence), warranty, breach of contract or any other legal theory.

Notwithstanding any damages that customer might incur for any reason whatsoever, Nexperia's aggregate and cumulative liability towards customer for the products described herein shall be limited in accordance with the *Terms and conditions of commercial sale* of Nexperia.

Right to make changes — Nexperia reserves the right to make changes to information published in this document, including without limitation specifications and product descriptions, at any time and without notice. This document supersedes and replaces all information supplied prior to the publication hereof.

Suitability for use — Nexperia products are not designed, authorized or warranted to be suitable for use in life support, life-critical or safety-critical systems or equipment, nor in applications where failure or malfunction of a Nexperia product can reasonably be expected to result in personal injury, death or severe property or environmental damage. Nexperia and its suppliers accept no liability for inclusion and/or use of Nexperia products in such equipment or applications and therefore such inclusion and/or use is at the customer's own risk.

Applications — Applications that are described herein for any of these products are for illustrative purposes only. Nexperia makes no representation or warranty that such applications will be suitable for the specified use without further testing or modification.

Customers are responsible for the design and operation of their applications and products using Nexperia products, and Nexperia accepts no liability for any assistance with applications or customer product design. It is customer's sole responsibility to determine whether the Nexperia product is suitable and fit for the customer's applications and products planned, as well as for the planned application and use of customer's third party customer(s). Customers should provide appropriate design and operating safeguards to minimize the risks associated with their applications and products.

Nexperia does not accept any liability related to any default, damage, costs or problem which is based on any weakness or default in the customer's applications or products, or the application or use by customer's third party customer(s). Customer is responsible for doing all necessary testing for the customer's applications and products using Nexperia products in order to avoid a default of the applications and the products or of the application or use by customer's third party customer(s). Nexperia does not accept any liability in this respect.

Limiting values — Stress above one or more limiting values (as defined in the Absolute Maximum Ratings System of IEC 60134) will cause permanent damage to the device. Limiting values are stress ratings only and (proper) operation of the device at these or any other conditions above those given in the Recommended operating conditions section (if present) or the Characteristics sections of this document is not warranted. Constant or repeated exposure to limiting values will permanently and irreversibly affect the quality and reliability of the device.

Terms and conditions of commercial sale — Nexperia products are sold subject to the general terms and conditions of commercial sale, as published at <http://www.nexperia.com/profile/terms>, unless otherwise agreed in a valid written individual agreement. In case an individual agreement is concluded only the terms and conditions of the respective agreement shall apply. Nexperia hereby expressly objects to applying the customer's general terms and conditions with regard to the purchase of Nexperia products by customer.

No offer to sell or license — Nothing in this document may be interpreted or construed as an offer to sell products that is open for acceptance or the grant, conveyance or implication of any license under any copyrights, patents or other industrial or intellectual property rights.

Export control — This document as well as the item(s) described herein may be subject to export control regulations. Export might require a prior authorization from competent authorities.

Quick reference data — The Quick reference data is an extract of the product data given in the Limiting values and Characteristics sections of this document, and as such is not complete, exhaustive or legally binding.

Non-automotive qualified products — Unless this data sheet expressly states that this specific Nexperia product is automotive qualified, the product is not suitable for automotive use. It is neither qualified nor tested in accordance with automotive testing or application requirements. Nexperia accepts no liability for inclusion and/or use of non-automotive qualified products in automotive equipment or applications.

In the event that customer uses the product for design-in and use in automotive applications to automotive specifications and standards, customer (a) shall use the product without Nexperia's warranty of the product for such automotive applications, use and specifications, and (b) whenever customer uses the product for automotive applications beyond Nexperia's specifications such use shall be solely at customer's own risk, and (c) customer fully indemnifies Nexperia for any liability, damages or failed product claims resulting from customer design and use of the product for automotive applications beyond Nexperia's standard warranty and Nexperia's product specifications.

11.4 Trademarks

Notice: All referenced brands, product names, service names and trademarks are the property of their respective owners.

12. Contact information

For more information, please visit: <http://www.nexperia.com>

For sales office addresses, please send an email to: salesaddresses@nexperia.com

13. Contents

| | | |
|-----------|--|-----------|
| 1 | Product profile | 1 |
| 1.1 | General description | 1 |
| 1.2 | Features and benefits | 1 |
| 1.3 | Applications | 1 |
| 2 | Pinning information | 2 |
| 3 | Ordering information | 3 |
| 4 | Marking | 3 |
| 5 | Limiting values | 4 |
| 6 | Characteristics | 4 |
| 7 | Application information | 5 |
| 8 | Package outline | 7 |
| 9 | Soldering | 8 |
| 10 | Revision history | 11 |
| 11 | Legal information | 12 |
| 11.1 | Data sheet status | 12 |
| 11.2 | Definitions | 12 |
| 11.3 | Disclaimers | 12 |
| 11.4 | Trademarks | 13 |
| 12 | Contact information | 13 |
| 13 | Contents | 14 |