



## VARIABLE GAIN AMPLIFIER 17 - 27 GHz

### Typical Applications

The HMC997LC4 is ideal for:

- Point-to-Point Radio
- Point-to-Multi-Point Radio
- EW & ECM Subsystems
- Ka-Band Radar
- Test Equipment

### Features

- Wide Gain Control Range: 15 dB
- Single Control Voltage
- Output IP3 @ Max Gain: +31 dBm
- Output P1dB: +24 dBm
- No External Matching
- 24 Lead 4 x 4 mm SMT Package: 16 mm<sup>2</sup>

### Functional Diagram

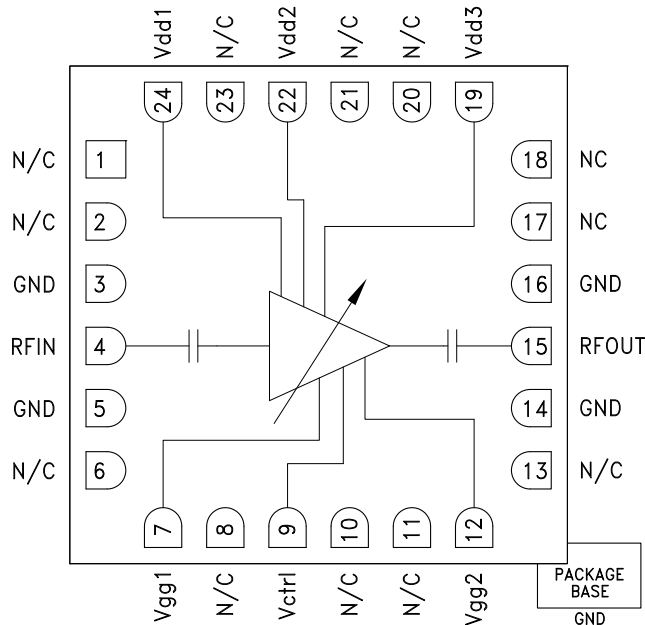

### General Description

The HMC997LC4 is a GaAs MMIC PHEMT analog variable gain amplifier and/or driver amplifier which operates between 17 and 27 GHz. Ideal for microwave radio applications, the amplifier provides up to 20.5 dB of gain, output P1dB of up to +24 dBm, and up to +31 dBm of output IP3 at maximum gain, while requiring only 170 mA from a +5V supply. A gain control voltage (Vctrl) is provided to allow variable gain control up to 15 dB. Gain flatness is excellent making the HMC997LC4 ideal for EW, ECM and radar applications. The HMC997LC4 is housed in a RoHS compliant 4 x 4 mm ceramic QFN leadless package and is compatible with high volume surface mount manufacturing.

### Electrical Specifications, $T_A = +25\text{ }^\circ\text{C}$ , $V_{dd1, 2, 3} = 5\text{V}$ , $V_{ctrl} = -4.5\text{V}$ , $I_{dd} = 170\text{ mA}^*$

Parameter	Min.	Typ.	Max.	Min.	Typ.	Max.	Units
Frequency Range		17 - 21		21 - 27			GHz
Gain	17.0	20		16	19		dB
Gain Flatness		$\pm 0.3$			$\pm 0.7$		dB
Gain Variation Over Temperature		0.02			0.02		dB/ $^\circ\text{C}$
Gain Control Range	12	15		12	14		dB
Noise Figure		4.0			3.5		dB
Input Return Loss		13			12		dB
Output Return Loss		17			19		dB
Output Power for 1 dB Compression (P1dB)	21	24		21	24		dBm
Saturated Output Power (Psat)		25			24.5		dBm
Output Third Order Intercept (IP3)		31			30		dBm
Total Supply Current (Idd)		170			170		mA

\*Set Vctrl = -4.5V and then adjust Vgg1, 2 between -2V to 0V to achieve Idd = 170 mA typical.



**VARIABLE GAIN AMPLIFIER  
17 - 27 GHz**

**Gain vs. Control Voltage Range**

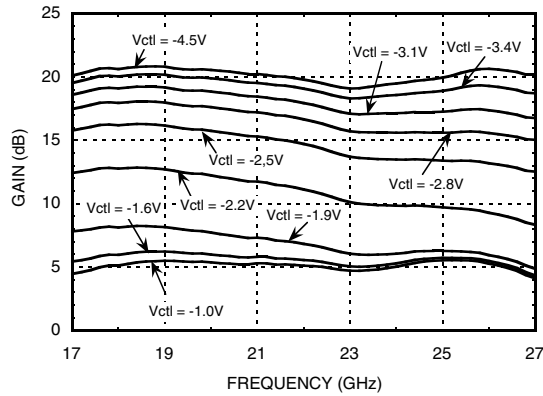

**Gain vs. Control Voltage**

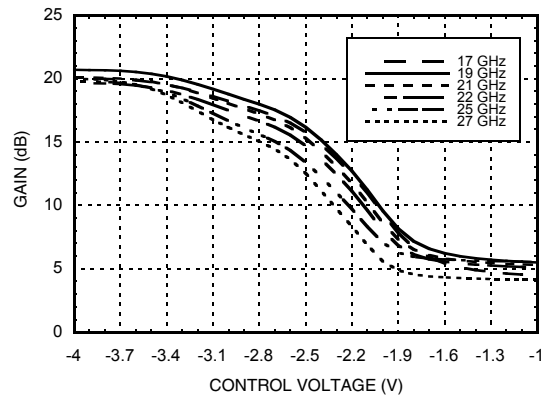

**Broadband Gain & Return Loss**

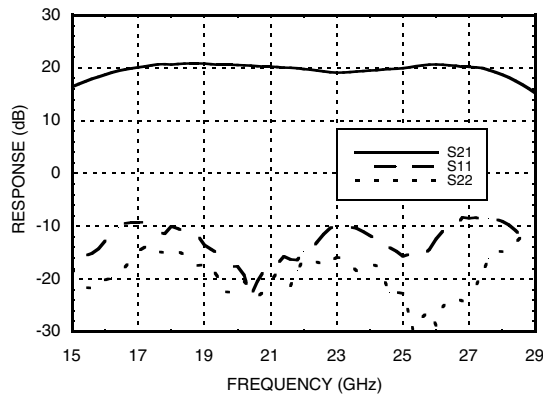

**Gain vs. Temperature**

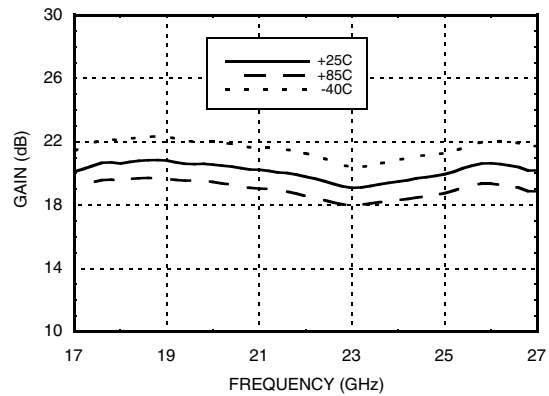

**Input Return Loss vs. Temperature**

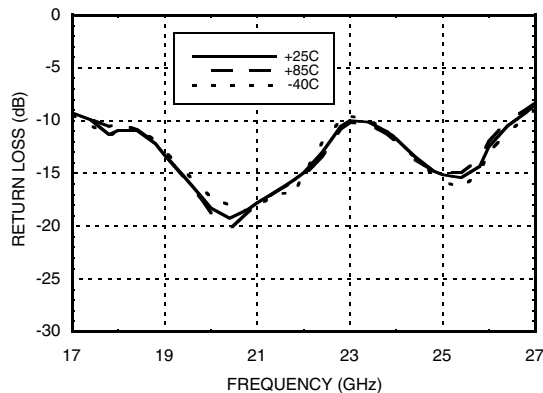

**Output Return Loss vs. Temperature**

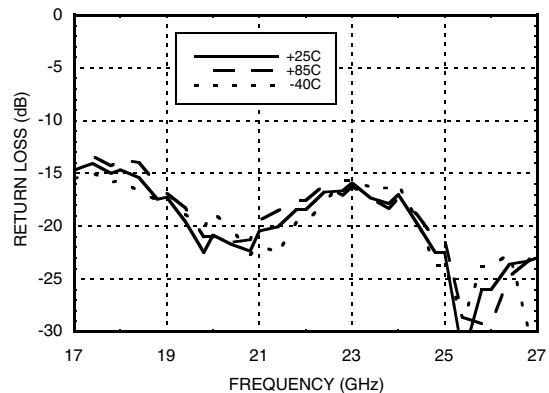



**VARIABLE GAIN AMPLIFIER  
17 - 27 GHz**

VARIABLE GAIN AMPLIFIER - SMT

**Input Return Loss @  
Control Voltage Extreme**

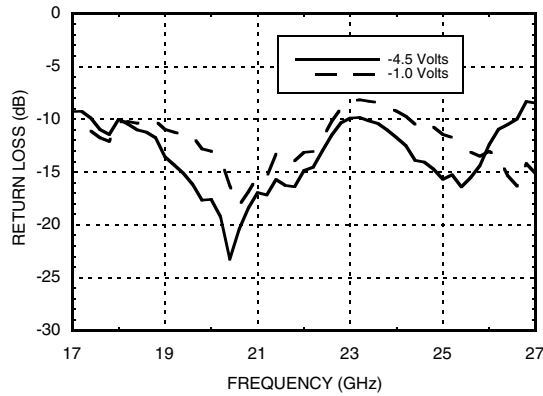

**Output Return Loss @  
Control Voltage Extreme**

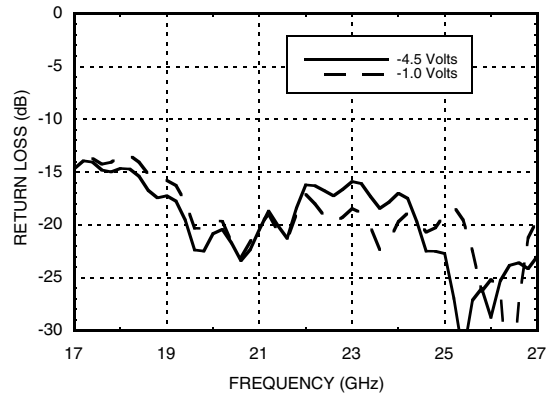

**Noise Figure vs. Temperature**

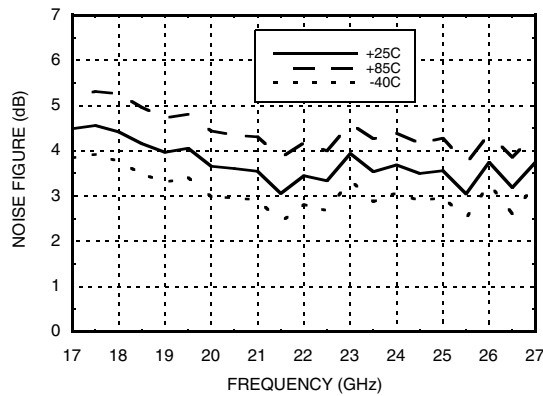

**Noise Figure vs. Control Voltage**

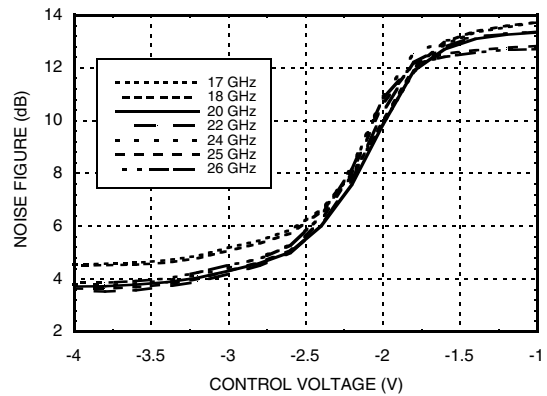

**P1dB vs. Temperature**

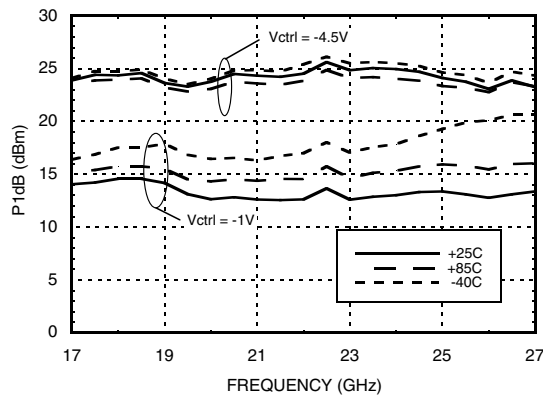

**Psat vs. Temperature**

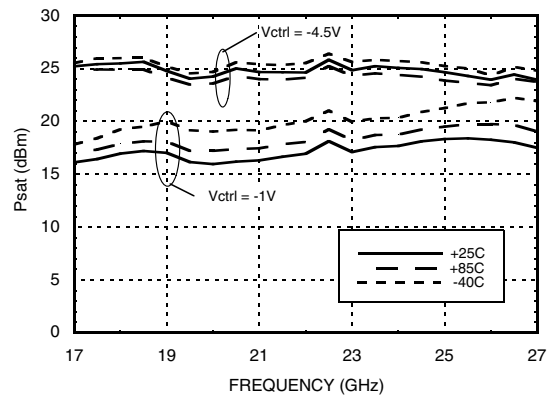

[1] Tested with broadband bias tee on RF ports and C1 = 10,000 pF  
[2] C1, C6 and C8 = 100 pF, L1 = 24 nF



**VARIABLE GAIN AMPLIFIER  
17 - 27 GHz**

**Reverse Isolation vs. Temperature**

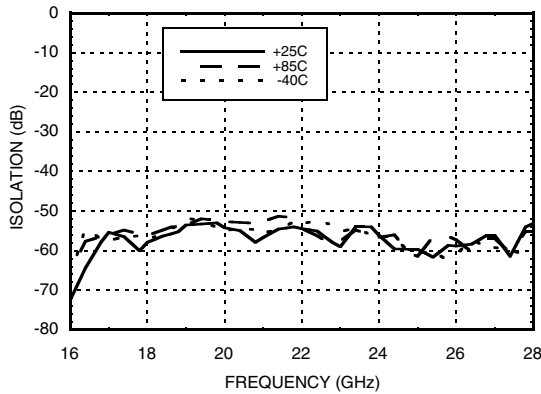

**Output IP3 vs. Temperature**

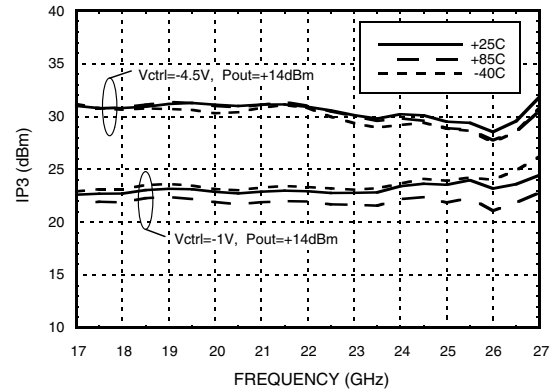

**IP3 and Gain @ 18 GHz Pin = -20 dBm**

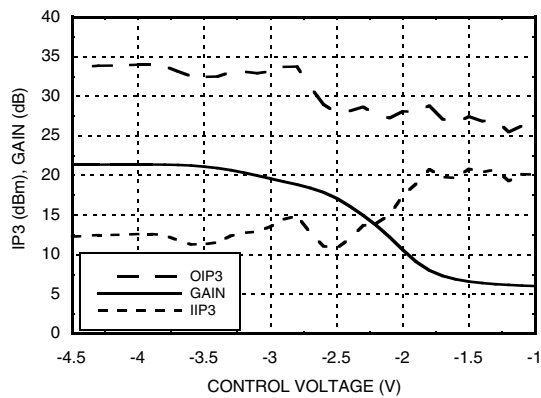

**IP3 and Gain @ 22 GHz Pin = -20 dBm**

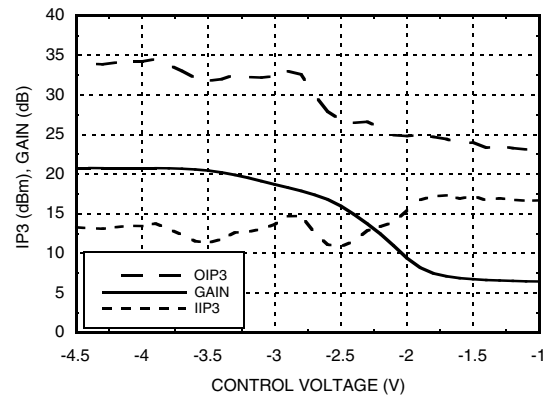

**IP3 and Gain @ 26 GHz Pin = -20 dBm**

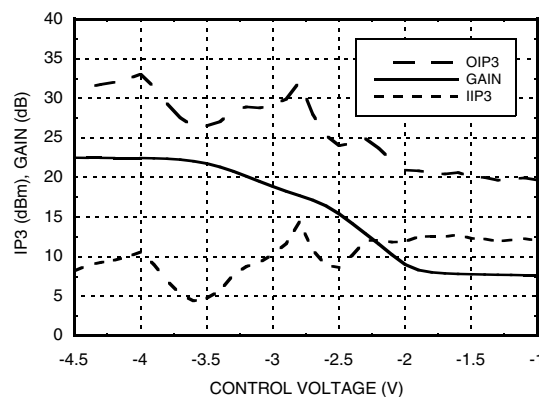

Information furnished by Analog Devices is believed to be accurate and reliable. However, no responsibility is assumed by Analog Devices for its use, nor for any infringements of patents or other rights of third parties that may result from its use. Specifications subject to change without notice. No license is granted by implication or otherwise under any patent or patent rights of Analog Devices. Trademarks and registered trademarks are the property of their respective owners.

For price, delivery, and to place orders: Analog Devices, Inc., One Technology Way, P.O. Box 9106, Norwood, MA 02062-9106 Phone: 781-329-4700 • Order online at [www.analog.com](http://www.analog.com) Application Support: Phone: 1-800-ANALOG-D

## VARIABLE GAIN AMPLIFIER 17 - 27 GHz



### Absolute Maximum Ratings

Drain Bias Voltage (Vdd1, 2, 3)	+5.5V
Gate Bias Voltage (Vgg1, 2)	-3 to 0V
Gain Control Voltage (Vctrl)	-5 to 0V
RF Power Input (RFIN)	+5 dBm
Channel Temperature	175 °C
Continuous P <sub>diss</sub> (T = 85 °C) (derate 10.2 mW/°C above 85 °C) [1]	0.92 W
Thermal Resistance (Channel to ground paddle)	97.6 °C/W
Storage Temperature	-65 to +150 °C
Operating Temperature	-40 to +85 °C
ESD Sensitivity (HBM)	Class 0 Passed 100V

### Bias Voltage

Vdd1,2,3 (V)	I <sub>dd</sub> Total (mA)
+5V	170
Vgg1,2 (V)	I <sub>gg</sub> Total (mA)
0V to -2V	<0.1 mA



**ELECTROSTATIC SENSITIVE DEVICE  
OBSERVE HANDLING PRECAUTIONS**

### Outline Drawing

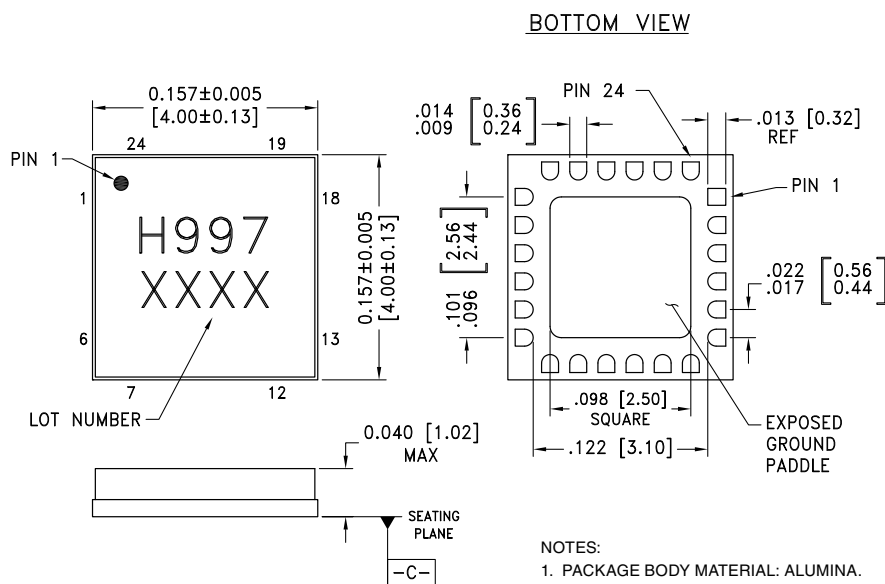

#### NOTES:

1. PACKAGE BODY MATERIAL: ALUMINA.
2. LEAD AND GROUND PADDLE PLATING: GOLD FLASH OVER NICKEL.
3. DIMENSIONS ARE IN INCHES (MILLIMETERS).
4. LEAD SPACING TOLERANCE IS NON-CUMULATIVE.
5. PACKAGE WARP SHALL NOT EXCEED 0.05 MM DATUM -C-
6. ALL GROUND LEADS AND GROUND PADDLE MUST BE SOLDERED TO PCB RF GROUND.

### Package Information

Part Number	Package Body Material	Lead Finish	MSL Rating	Package Marking [2]
HMC997LC4	Alumina, White	Gold over Nickel	MSL3 [1]	H997 XXXX

[1] Max peak reflow temperature of 260 °C

[2] 4-Digit lot number XXXX

## VARIABLE GAIN AMPLIFIER 17 - 27 GHz

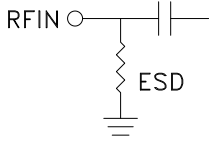
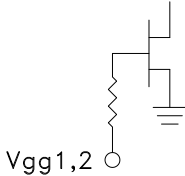
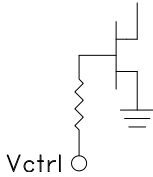
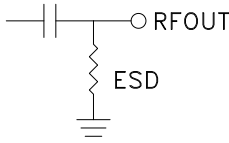
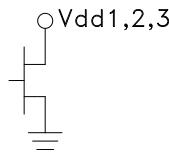

### Pin Descriptions

Pin Number	Function	Description	Interface Schematic
1, 2, 6, 8, 10, 11, 13, 17, 18, 20, 21, 23	N/C	The pins are not connected internally; however all data shown herein was measured with these pins connected to RF/DC ground externally	
3, 5, 14, 16	GND	These pins and the exposed ground paddle must be connected to RF/DC ground.	
4	RFIN	This pad is AC coupled and matched to 50 Ohm.	
7, 12	Vgg1, 2	Gate control for amplifier. Adjust voltage to achieve typical I <sub>dd</sub> . Please follow "MMIC Amplifier Biasing Procedure" application note.	
9	Vctrl	Gain control Voltage for the amplifier. See assembly diagram for required external components.	
15	RFOUT	This pad is AC coupled and matched to 50 Ohm.	
19, 22, 24	Vdd3, 2, 1	Drain Bias Voltage for the amplifier. See assembly diagram for required external components	



**VARIABLE GAIN AMPLIFIER  
17 - 27 GHz**

**Application Circuit**

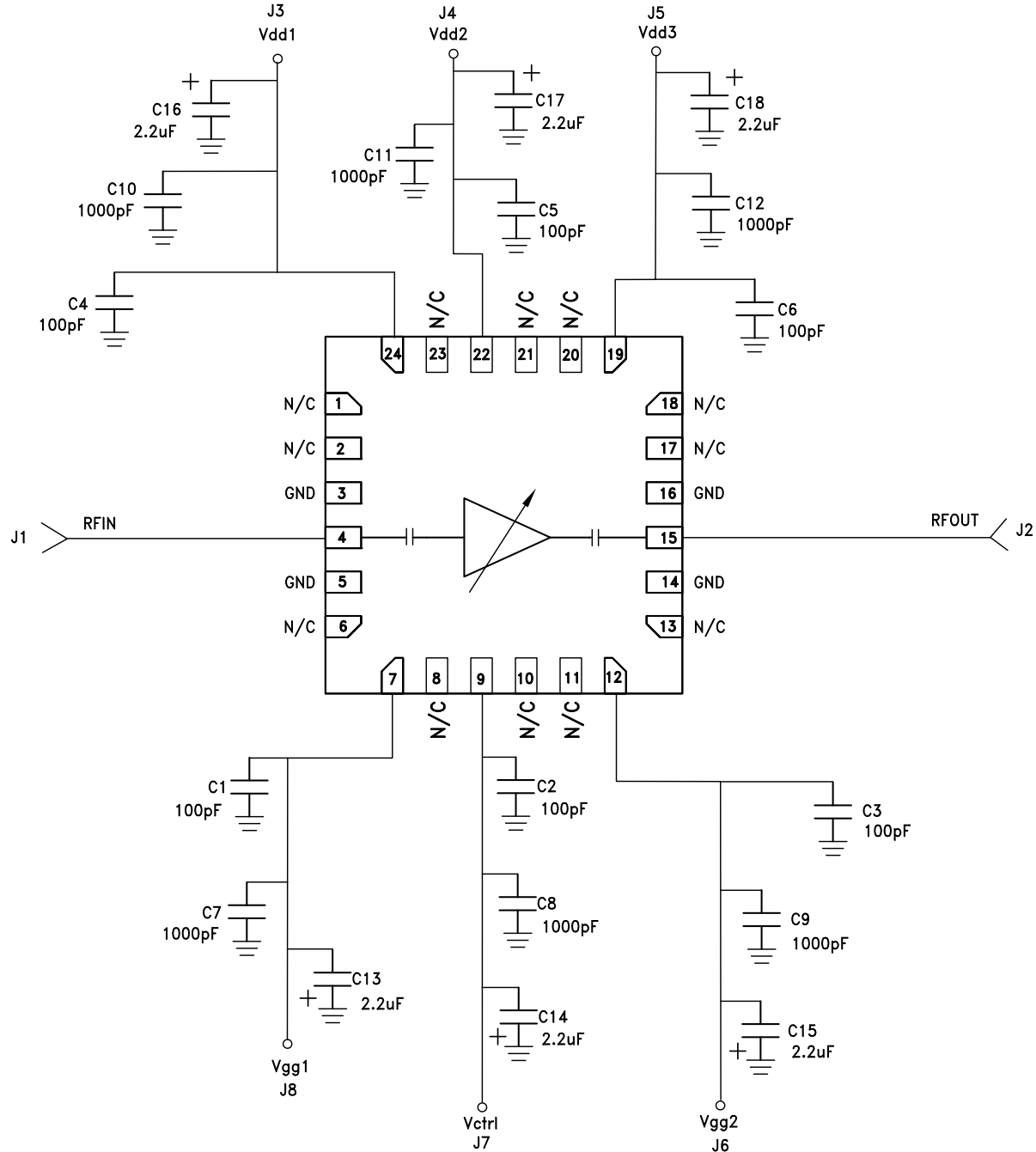

Information furnished by Analog Devices is believed to be accurate and reliable. However, no responsibility is assumed by Analog Devices for its use, nor for any infringements of patents or other rights of third parties that may result from its use. Specifications subject to change without notice. No license is granted by implication or otherwise under any patent or patent rights of Analog Devices. Trademarks and registered trademarks are the property of their respective owners.

For price, delivery, and to place orders: Analog Devices, Inc., One Technology Way, P.O. Box 9106, Norwood, MA 02062-9106 Phone: 781-329-4700 • Order online at [www.analog.com](http://www.analog.com) Application Support: Phone: 1-800-ANALOG-D



**Evaluation PCB**

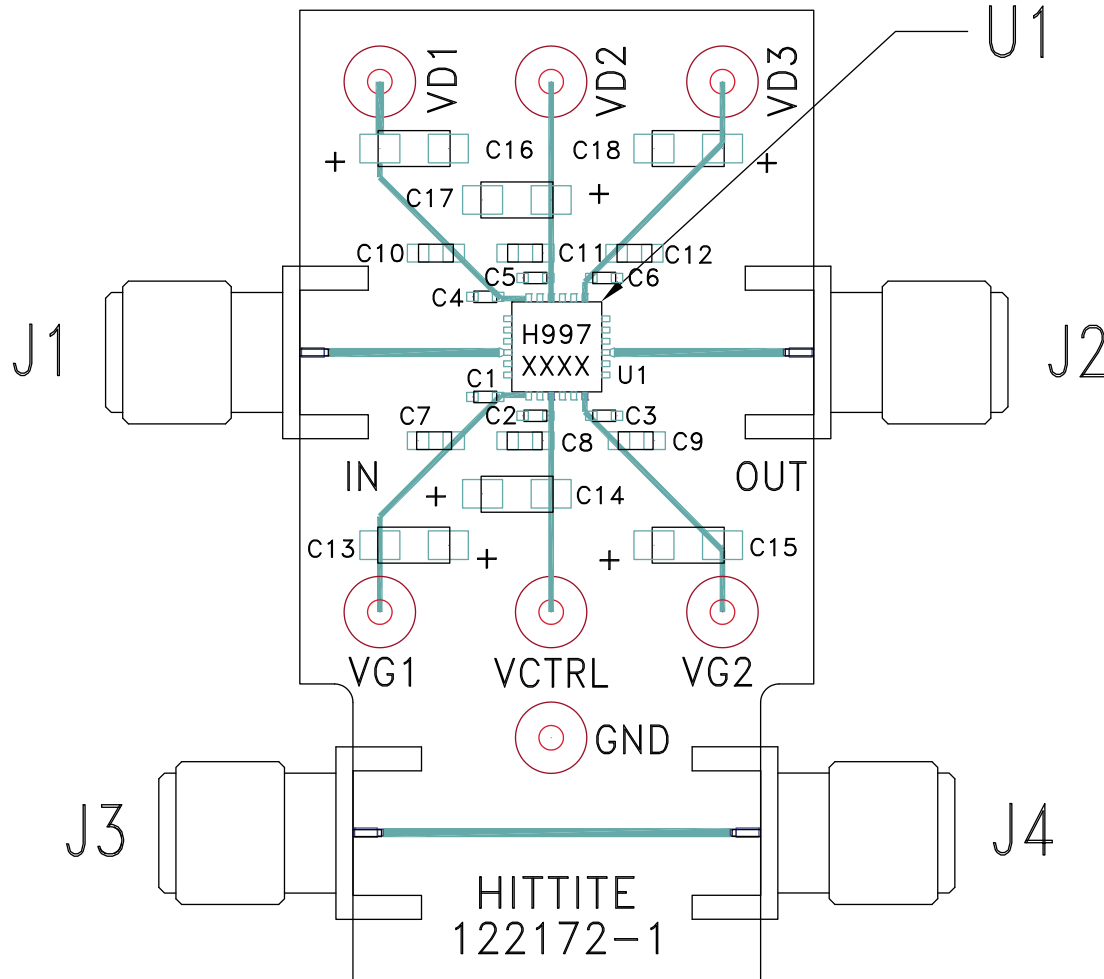

**List of Materials for Evaluation PCB**

**EVAL01-HMC997LC4 [1]**

Item	Description
J1, J4	PCB Mount SMA RF Connectors
J5 - J10	DC Pin
C1 - C6	100 pF Capacitor, 0402 Pkg.
C7 - C12	1000 pF Capacitor, 0603 Pkg.
C13 - C18	2.2 μF Capacitor, CASE A
U1	HMC997LC4 Variable Gain Amplifier
PCB [2]	122172 Evaluation PCB

[1] Reference this number when ordering complete evaluation PCB

[2] Circuit Board Material: Arlon 25 FR

The circuit board used in the application should use RF circuit design techniques. Signal lines should have 50 Ohm impedance while the package ground leads and exposed paddle should be connected directly to the ground plane similar to that shown. A sufficient number of via holes should be used to connect the top and bottom ground planes. The evaluation circuit board shown is available from Hittite upon request.