

FEATURES

Output power for 1 dB compression (P1dB): 16.5 dBm typical
Saturated output power (P_{SAT}): 19 dBm typical
Gain: 14.5 dB typical
Noise figure: 1.5 dB
Output third order intercept (IP3): 26 dBm typical
Supply voltage: 7.5 V at 60 mA
50 Ω matched input/output
Die size: 2.55 mm x 1.62 mm x 0.05 mm

APPLICATIONS

Test instrumentation
Microwave radios and very small aperture terminals (VSATs)
Military and space
Telecommunications infrastructure
Fiber optics

GENERAL DESCRIPTION

The **HMC8401** is a gallium arsenide (GaAs), pseudomorphic high electron mobility transistor (pHEMT), monolithic microwave integrated circuit (MMIC). The **HMC8401** is a wideband low noise amplifier which operates between dc and 28 GHz. The amplifier provides 14.5 dB of gain, 1.5 dB noise figure, 26 dBm output IP3 and 16.5 dBm of output power at 1 dB gain compression while requiring 60 mA from a 7.5 V supply. The **HMC8401** also has a gain control option, V_{GG2}. The **HMC8401** amplifier input/outputs are internally matched to 50 Ω facilitating integration into multichip modules (MCMs). All data is taken with the chip connected via two 0.025 mm (1 mil) wire bonds of minimal length 0.31 mm (12 mils).

FUNCTIONAL BLOCK DIAGRAM

Figure 1.

Rev. B
Document Feedback

Information furnished by Analog Devices is believed to be accurate and reliable. However, no responsibility is assumed by Analog Devices for its use, nor for any infringements of patents or other rights of third parties that may result from its use. Specifications subject to change without notice. No license is granted by implication or otherwise under any patent or patent rights of Analog Devices. Trademarks and registered trademarks are the property of their respective owners.

TABLE OF CONTENTS

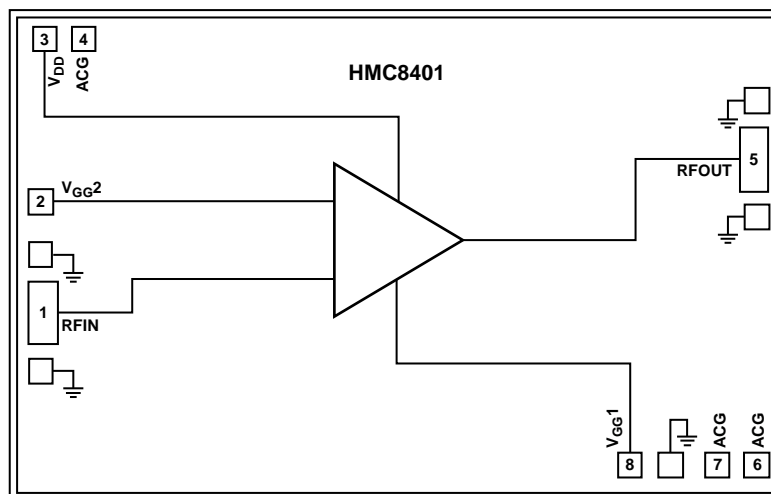
Features	1	Interface Schematics	7
Applications	1	Typical Performance Characteristics	8
General Description	1	Theory of Operation	14
Functional Block Diagram	1	Applications Information	15
Revision History	2	Biasing Procedures	15
Specifications	3	Mounting and Bonding Techniques for Millimeterwave GaAs MMICs	15
0.01 GHz to 3 GHz Frequency Range	3	Typical Application Circuit	16
3 GHz to 26 GHz Frequency Range	3	Assembly Diagram	16
26 GHz to 28 GHz Frequency Range	4	Outline Dimensions	17
Absolute Maximum Ratings	5	Ordering Guide	17
ESD Caution	5		
Pin Configuration and Function Descriptions	6		

REVISION HISTORY

4/2018—Rev. A to Rev. B

Changes to Features Section	1
Updated Outline Dimensions	17
Changes to Ordering Guide	17

9/2017—Rev. 0 to Rev. A

Changes to Supply Voltage Parameter, Table 1	3
Changes to Supply Voltage Parameter, Table 2	3
Changes to Supply Voltage Parameter, Table 3	4
Changes to Thermal Resistance, θ_{JC} (Channel to Die Bottom) Parameter Heading, Table 4	5
Changes to Table 5	6
Changes to Figure 7	7
Added Figure 41; Renumbered Sequentially	13

7/2016—Revision 0: Initial Version

SPECIFICATIONS

0.01 GHz TO 3 GHz FREQUENCY RANGE

$T_A = 25^\circ\text{C}$, $V_{DD} = 7.5\text{ V}$, $I_{DQ} = 60\text{ mA}$, $V_{GG2} = \text{open}$, unless otherwise stated.¹ When using V_{GG2} , it is recommended to limit V_{GG2} from -2 V to $+2.6\text{ V}$.

Table 1.

Parameter	Symbol	Test Conditions/Comments	Min	Typ	Max	Unit
FREQUENCY RANGE			0.01		3	GHz
GAIN			13	15		dB
Gain Variation Over Temperature				0.005		dB/°C
RETURN LOSS						
Input				14		dB
Output				19		dB
OUTPUT						
Output Power for 1 dB Compression	P1dB		14.5	17		dBm
Saturated Output Power	P_{SAT}			19		dBm
Output Third Order Intercept	IP3	Measurement taken at $P_{OUT}/\text{tone} = 10\text{ dBm}$		27		dBm
NOISE FIGURE	NF			2.5	4.5	dB
SUPPLY CURRENT						
Total Supply Current	I_{DQ}			60		mA
SUPPLY VOLTAGE	V_{DD}		4.5	7.5	8.5	V

¹ Adjust the V_{GG1} supply voltage between -2 V and 0 V to achieve $I_{DQ} = 60\text{ mA}$ typical.

3 GHz TO 26 GHz FREQUENCY RANGE

$T_A = 25^\circ\text{C}$, $V_{DD} = 7.5\text{ V}$, $I_{DQ} = 60\text{ mA}$, $V_{GG2} = \text{open}$, unless otherwise stated.¹ When using V_{GG2} , it is recommended to limit V_{GG2} from -2 V to $+2.6\text{ V}$.

Table 2.

Parameter	Symbol	Test Conditions/Comments	Min	Typ	Max	Unit
FREQUENCY RANGE			3		26	GHz
GAIN			12.5	14.5		dB
Gain Variation Over Temperature				0.007		dB/°C
RETURN LOSS						
Input				16		dB
Output				17		dB
OUTPUT						
Output Power for 1 dB Compression	P1dB		14	16.5		dBm
Saturated Output Power	P_{SAT}			19		dBm
Output Third Order Intercept	IP3	Measurement taken at $P_{OUT}/\text{tone} = 10\text{ dBm}$		26		dBm
NOISE FIGURE	NF			1.5	4.5	dB
SUPPLY CURRENT						
Total Supply Current	I_{DQ}			60		mA
SUPPLY VOLTAGE	V_{DD}		4.5	7.5	8.5	V

¹ Adjust the V_{GG1} supply voltage between -2 V and 0 V to achieve $I_{DQ} = 60\text{ mA}$ typical.

26 GHz TO 28 GHz FREQUENCY RANGE

$T_A = 25^\circ\text{C}$, $V_{DD} = 7.5\text{ V}$, $I_{DQ} = 60\text{ mA}$, $V_{GG2} = \text{open}$, unless otherwise stated.¹ When using V_{GG2} , it is recommended to limit V_{GG2} from -2 V to $+2.6\text{ V}$.

Table 3.

Parameter	Symbol	Test Conditions/Comments	Min	Typ	Max	Unit
FREQUENCY RANGE			26		28	GHz
GAIN			12.5	14.5		dB
Gain Variation Over Temperature				0.009		dB/°C
RETURN LOSS						
Input				15		dB
Output				17		dB
OUTPUT						
Output Power for 1 dB Compression	P1dB		11.5	14		dBm
Saturated Output Power	P_{SAT}			17		dBm
Output Third Order Intercept	IP3	Measurement taken at $P_{OUT}/\text{tone} = 10\text{ dBm}$		24		dBm
NOISE FIGURE	NF			2	4	dB
SUPPLY CURRENT						
Total Supply Current	I_{DQ}			60		mA
SUPPLY VOLTAGE	V_{DD}		4.5	7.5	8.5	V

¹ Adjust the V_{GG1} supply voltage between -2 V and 0 V to achieve $I_{DQ} = 60\text{ mA}$ typical.

ABSOLUTE MAXIMUM RATINGS

Table 4.

Parameter	Rating
Drain Bias Voltage (V_{DD})	+10 V
Second Gate Bias Voltage (V_{GG2})	-2.6 V to +3.6V
RF Input Power (RFIN)	20 dBm
Channel Temperature	175°C
Continuous Power Dissipation (P_{DISS} , $T_A = 85^\circ\text{C}$ (Derate 18.3 mW/°C Above 85°C))	1.67W
Thermal Resistance, θ_{JC} (Channel to Die Bottom)	54°C/W
Storage Temperature Range	-65°C to +150°C
Operating Temperature Range	-55°C to +85°C
ESD Sensitivity, Human Body Model (HBM)	Class 1A, 250 V

Stresses at or above those listed under Absolute Maximum Ratings may cause permanent damage to the product. This is a stress rating only; functional operation of the product at these or any other conditions above those indicated in the operational section of this specification is not implied. Operation beyond the maximum operating conditions for extended periods may affect product reliability.

ESD CAUTION



ESD (electrostatic discharge) sensitive device. Charged devices and circuit boards can discharge without detection. Although this product features patented or proprietary protection circuitry, damage may occur on devices subjected to high energy ESD. Therefore, proper ESD precautions should be taken to avoid performance degradation or loss of functionality.

PIN CONFIGURATION AND FUNCTION DESCRIPTIONS

HMC8401

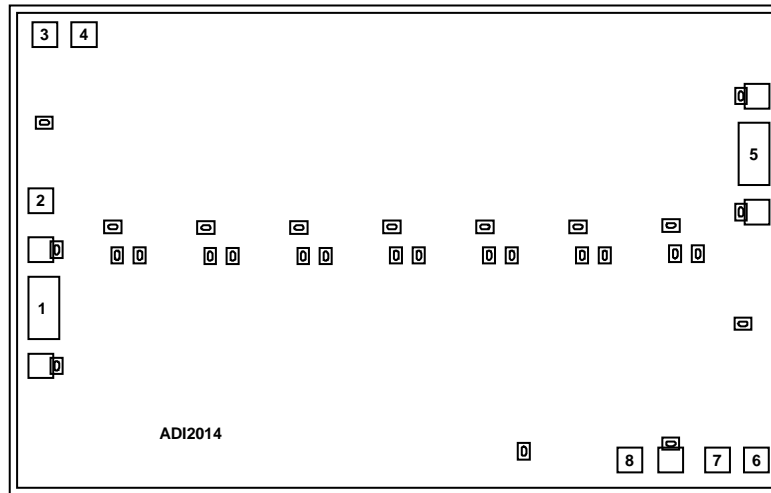

Figure 2. Pad Configuration

Table 5. Pad Function Descriptions

Pad No.	Mnemonic	Description
1	RFIN	Radio Frequency (RF) Input. This pad is dc coupled and matched to 50 Ω. See Figure 3 for the interface schematic.
2	V _{GG2}	Gain Control. This pad is dc-coupled and accomplishes gain control by bringing this voltage lower and becoming more negative. Attach bypass capacitors to this pad as shown in Figure 44. See Figure 4 for the interface schematic.
3	V _{DD}	Power Supply Voltage for the Amplifier. Connect a dc bias to provide drain current (I _{DD}). Attach bypass capacitors to this pad as shown in Figure 44. See Figure 5 for the interface schematic.
4, 6, 7	ACG	Low Frequency Termination. Attach bypass capacitors to this pad as shown in Figure 44. See Figure 6 for the interface schematic.
5	RFOUT	Radio Frequency (RF) Output. This pad is dc coupled and matched to 50 Ω. See Figure 3 for the interface schematic.
8	V _{GG1}	Gate Control for the Amplifier. Adjust V _{GG1} to achieve the recommended bias current. Attach bypass capacitors to this pad as shown in Figure 44. See Figure 8 for the interface schematic.
Die Bottom	GND	Die Bottom. The die bottom must be connected to RF/dc ground. See Figure 9 for the interface schematic.

INTERFACE SCHEMATICS

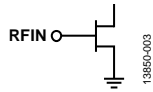

Figure 3. RFIN Interface Schematic

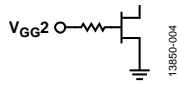

Figure 4. VGG2 Interface Schematic

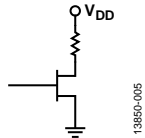

Figure 5. VDD Interface Schematic

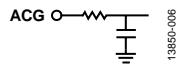

Figure 6. ACG Interface Schematic

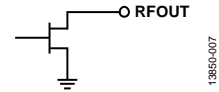

Figure 7. RFOUT Interface Schematic

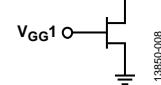

Figure 8. VGG1 Interface Schematic



Figure 9. GND Interface Schematic

TYPICAL PERFORMANCE CHARACTERISTICS

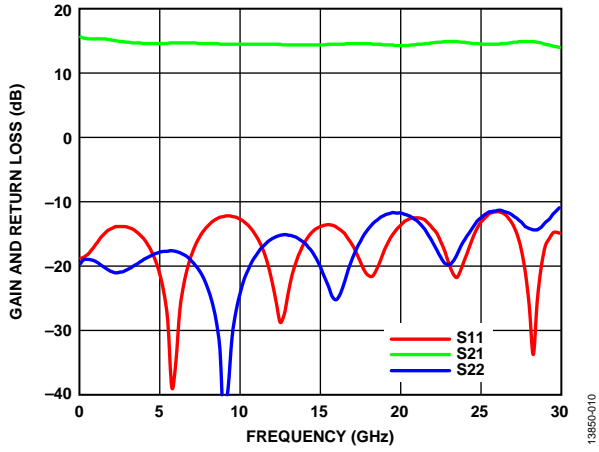

Figure 10. Response Gain and Return Loss vs. Frequency

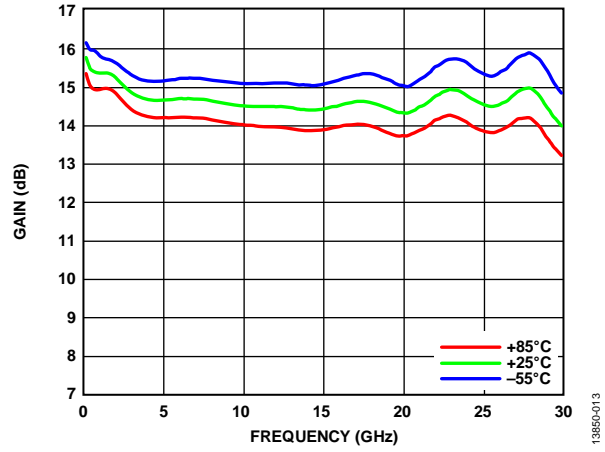

Figure 13. Gain vs. Frequency at Various Temperatures

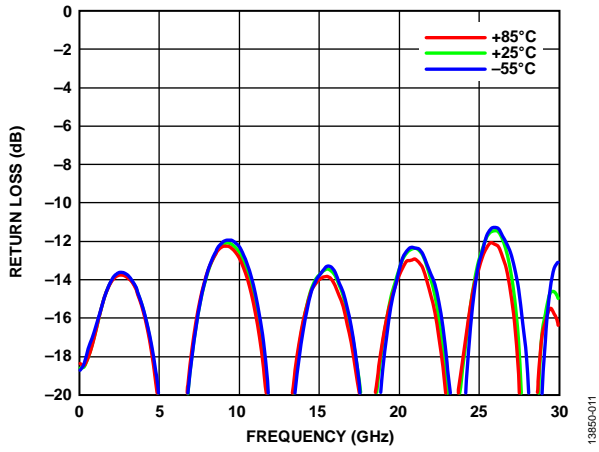

Figure 11. Input Return Loss vs. Frequency at Various Temperatures

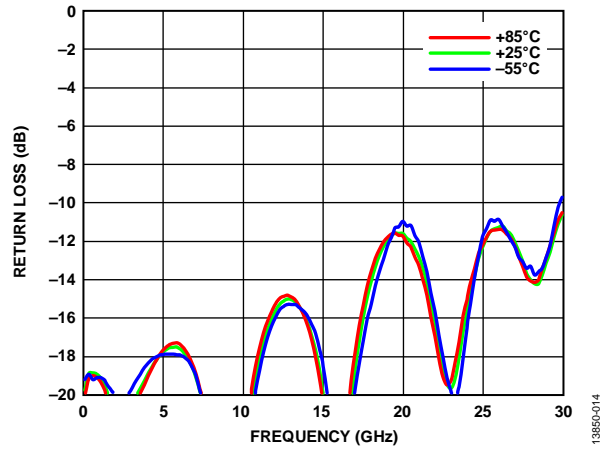

Figure 14. Output Return Loss vs. Frequency at Various Temperatures

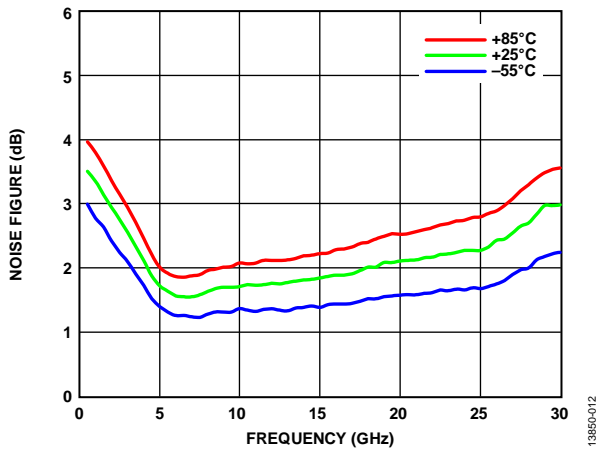

Figure 12. Noise Figure vs. Frequency at Various Temperatures

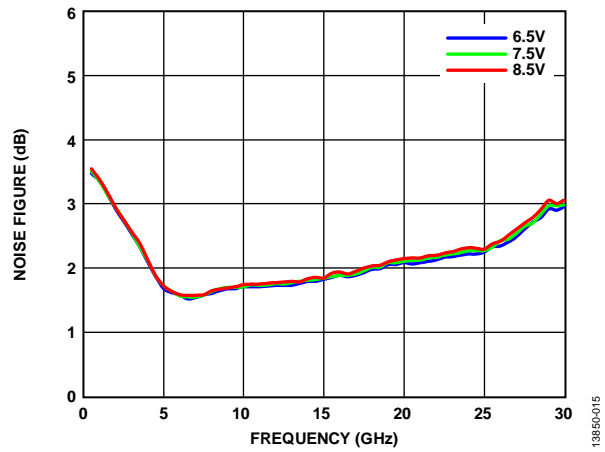

Figure 15. Noise Figure vs. Frequency at Various Supply Voltages

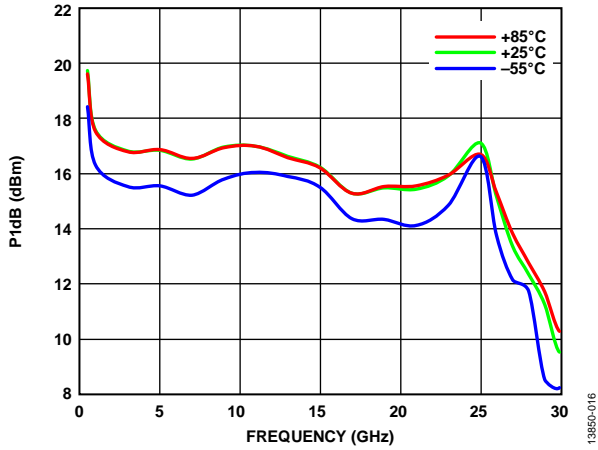

Figure 16. P1dB vs. Frequency at Various Temperatures

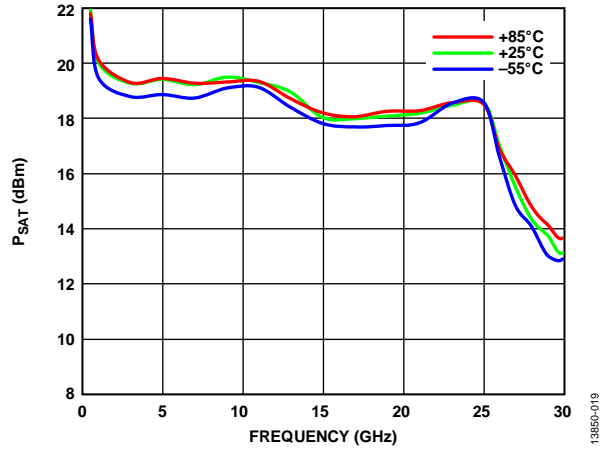

Figure 19. P_{SAT} vs. Frequency at Various Temperatures

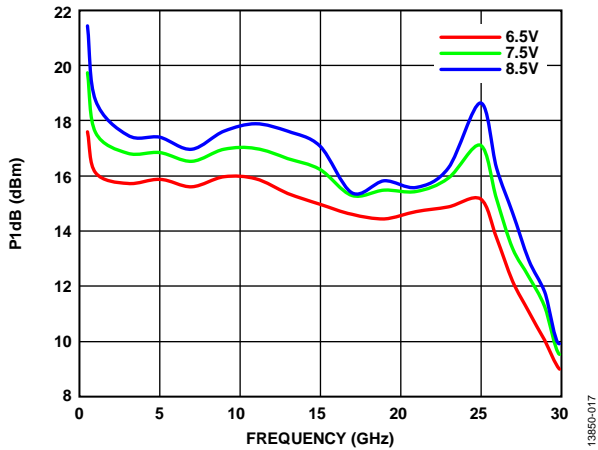

Figure 17. P1dB vs. Frequency at Various Supply Voltages

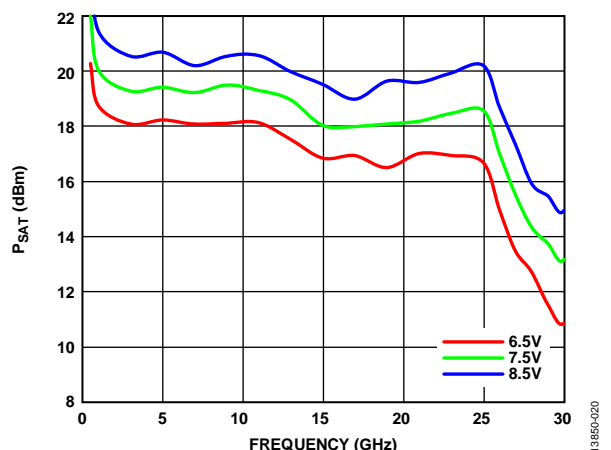

Figure 20. P_{SAT} vs. Frequency at Various Supply Voltages

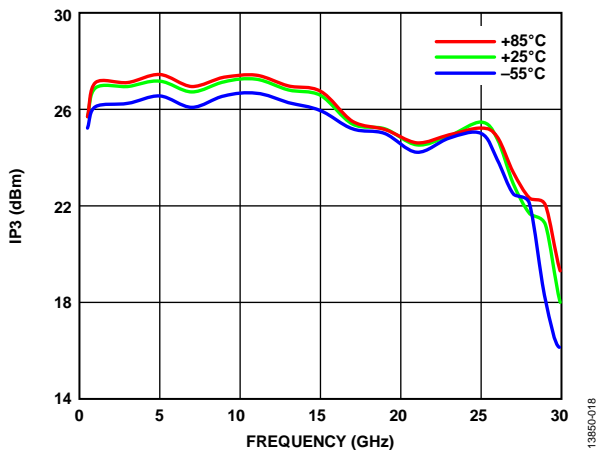

Figure 18. Output IP₃ vs. Frequency for Various Temperatures at P_{OUT} = 0 dBm/Tone

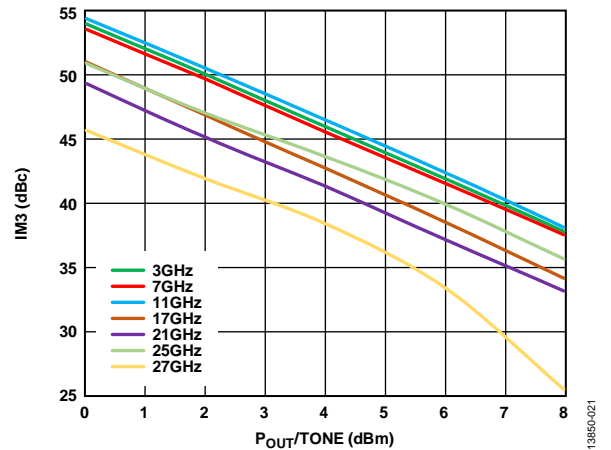

Figure 21. Output Third Order Intermodulation (IM₃) vs. P_{OUT}/Tone for Various Frequencies at V_{DD} = 6.5 V

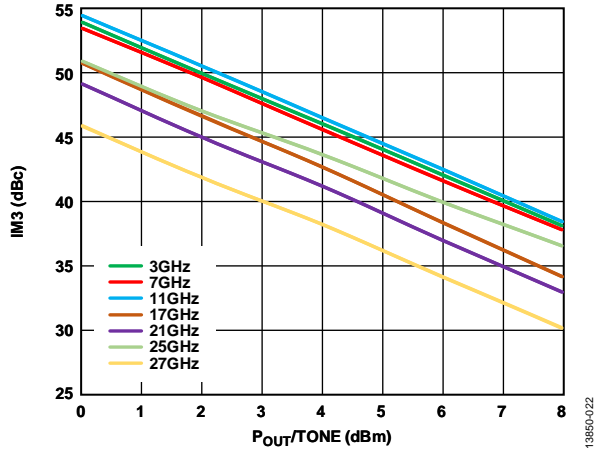

Figure 22. Output IM3 vs. $P_{OUT}/Tone$ for Various Frequencies at $V_{DD} = 7.5 V$

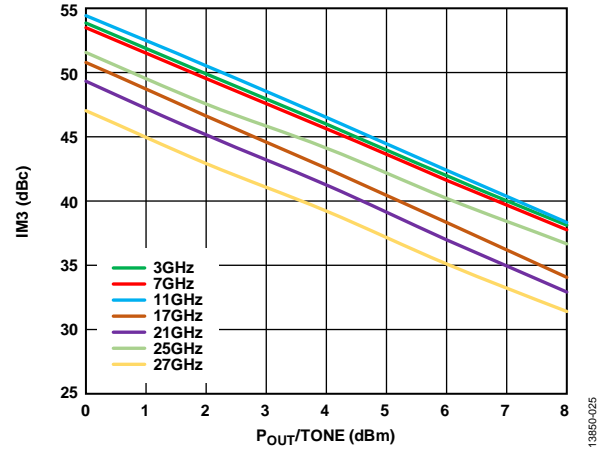

Figure 25. Output IM3 vs. $P_{OUT}/Tone$ for Various Frequencies at $V_{DD} = 8.5 V$

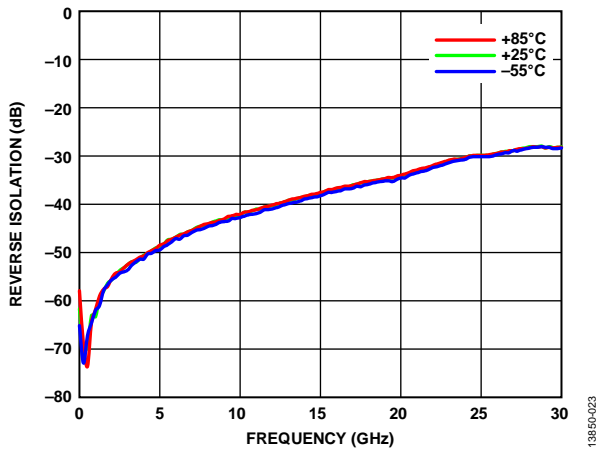

Figure 23. Reverse Isolation vs. Frequency at Various Temperatures

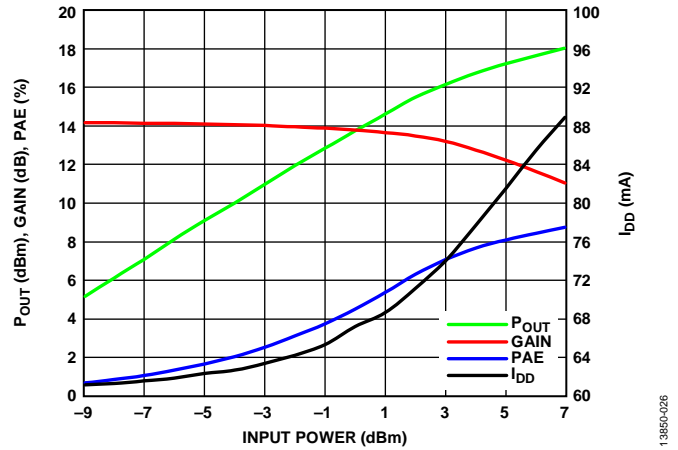

Figure 26. Power Compression at 15 GHz

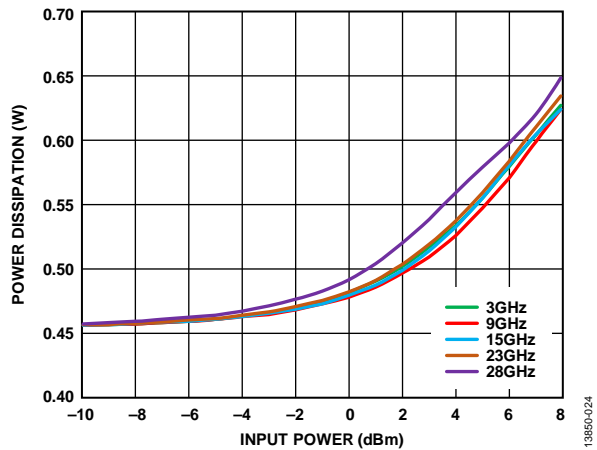

Figure 24. Power Dissipation vs. Input Power at Various Frequencies, $T_A = 85^\circ C$

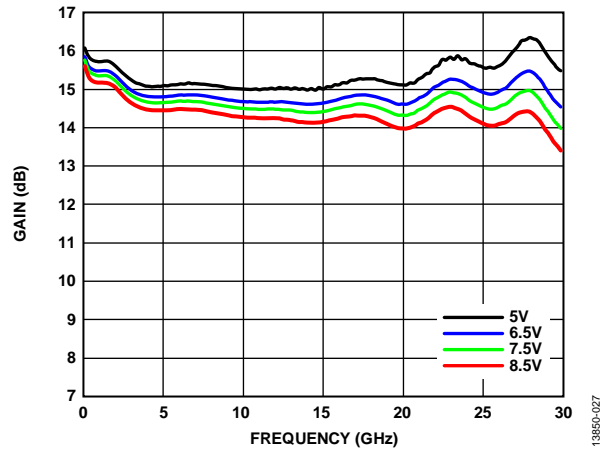

Figure 27. Gain vs. Frequency at Various Supply Voltages

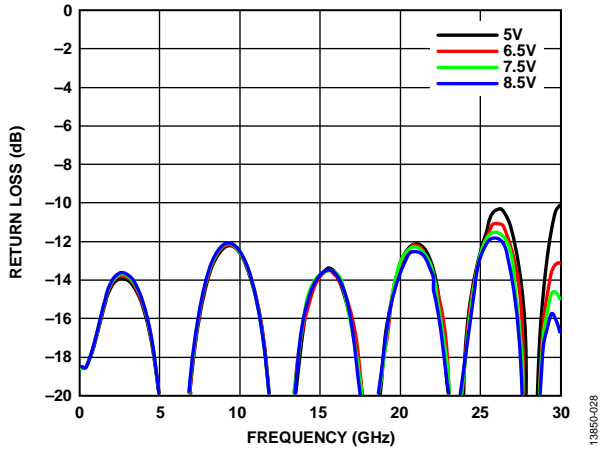

Figure 28. Input Return Loss vs. Frequency at Various Supply Voltages

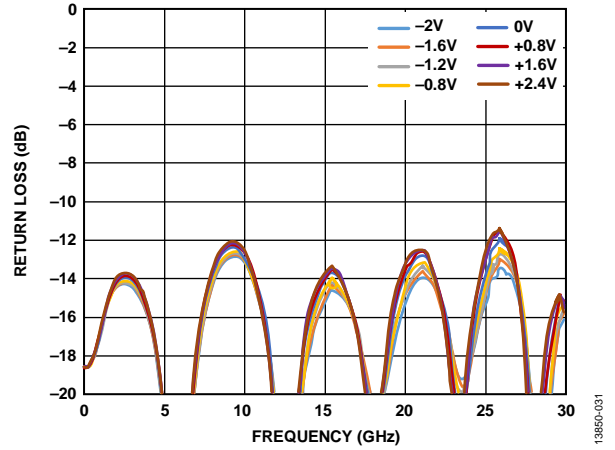

Figure 31. Input Return Loss vs. Frequency at Various V_{GG2} Voltages

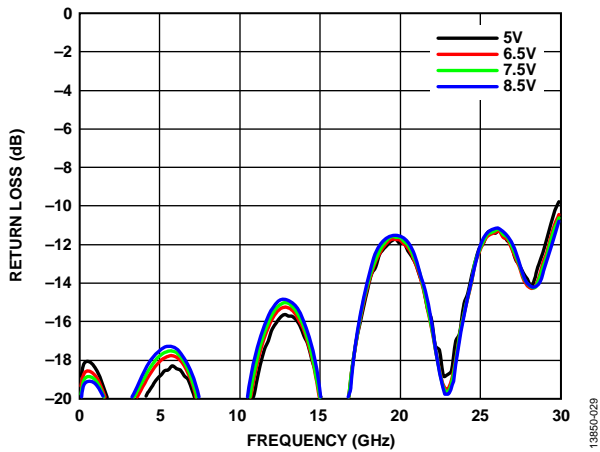

Figure 29. Output Return Loss vs. Frequency at Various Supply Voltages

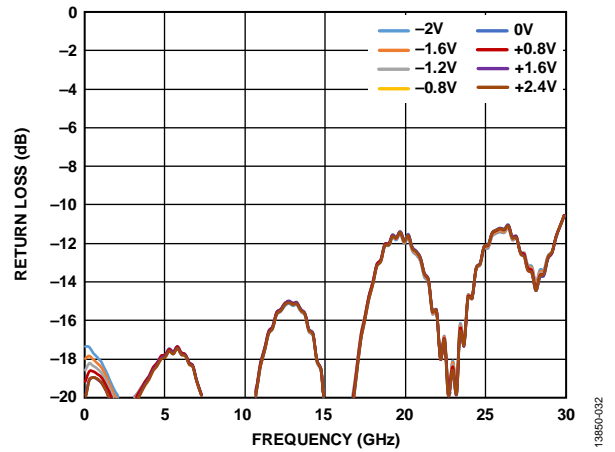

Figure 32. Output Return Loss vs. Frequency at Various V_{GG2} Voltages

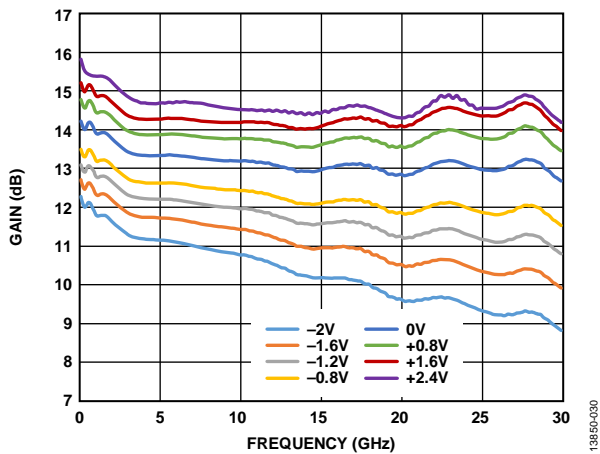

Figure 30. Gain vs. Frequency at Various V_{GG2} Voltages

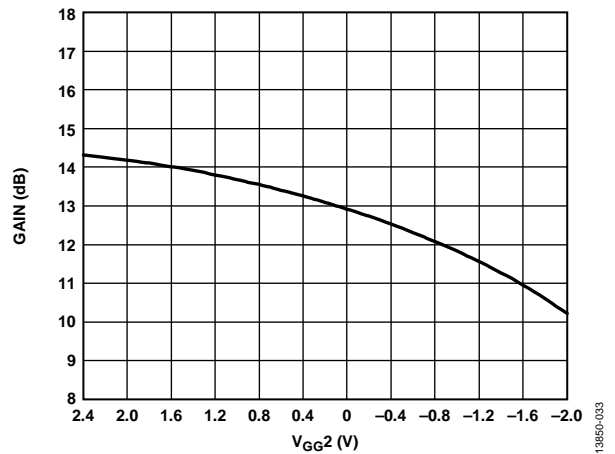

Figure 33. Gain vs. V_{GG2} at 14 GHz

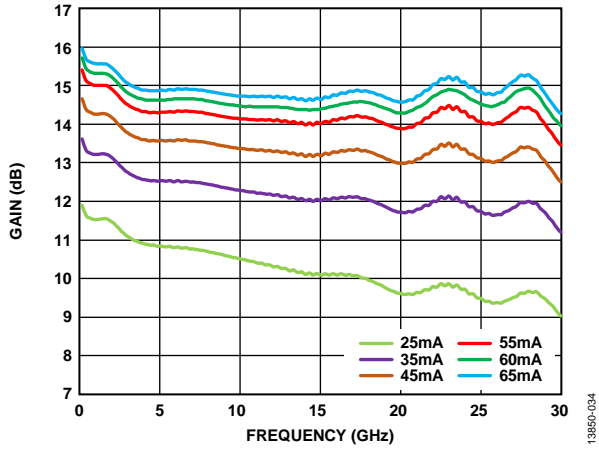

Figure 34. Gain vs. Frequency at Various I_{DQ} Currents

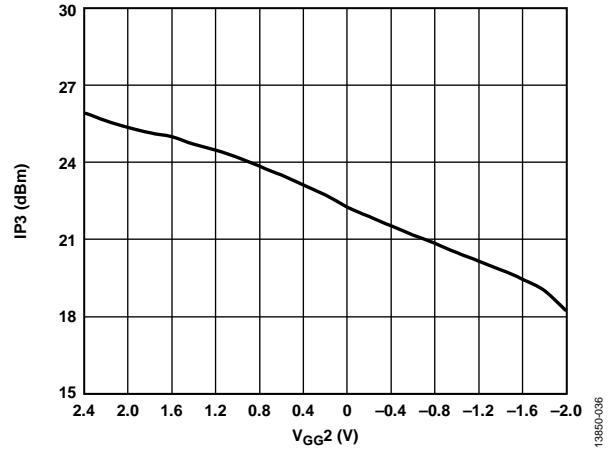

Figure 36. Output IP_3 vs. V_{GG2} at 16 GHz

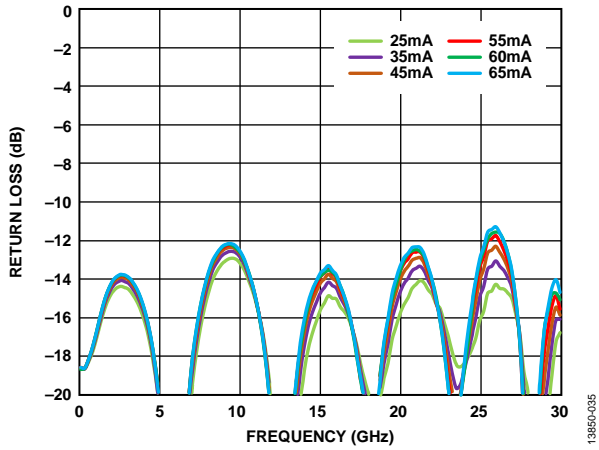

Figure 35. Input Return Loss vs. Frequency at Various I_{DQ} Currents

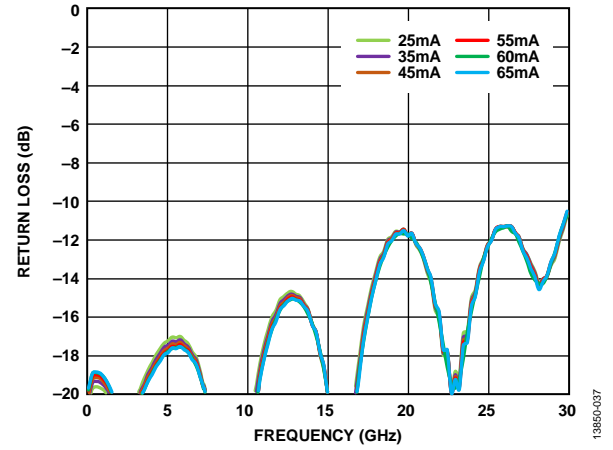

Figure 37. Output Return Loss vs. Frequency at Various I_{DQ} Currents

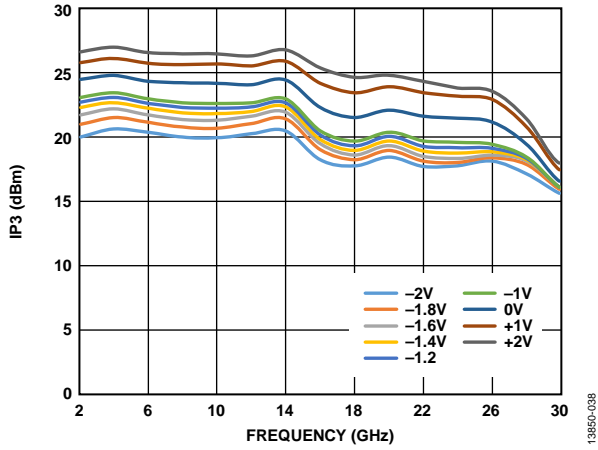

Figure 38. Output IP3 vs Frequency at Various V_{GG2} Voltages

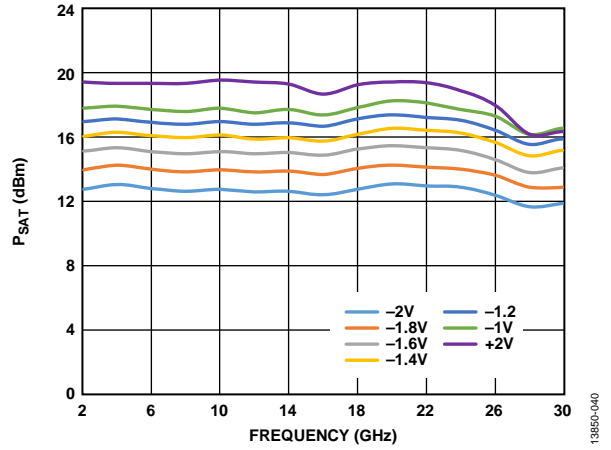

Figure 40. P_{SAT} vs. Frequency at Various V_{GG2} Voltages

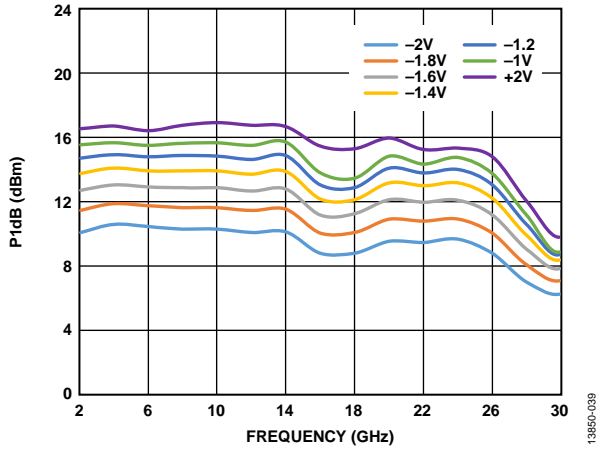

Figure 39. P1dB vs. Frequency at Various V_{GG2} Voltages

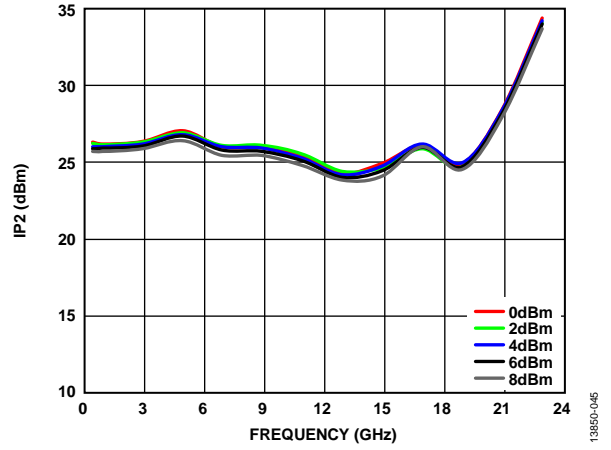

Figure 41. OIP2 vs. Frequency at Various RF Pout

THEORY OF OPERATION

The HMC8401 is a GaAs, pHEMT, MMIC low noise amplifier. Its basic architecture is that of a cascode distributed amplifier with an integrated resistor for the drain. The cascode distributed architecture uses a fundamental cell consisting of a stack of two field effect transistors (FETs) with the source of the upper FET connected to drain of the lower FET. The fundamental cell is then duplicated several times with an RFIN transmission line interconnecting the gates of the lower FETs and an RFOUT transmission line interconnecting the drains of the upper FETs.

Additional circuit design techniques are used around each cell to optimize the overall bandwidth and noise figure. The major benefit of this architecture is that a low noise figure is maintained across a bandwidth far greater than what a single instance of the fundamental cell provides. A simplified schematic of this architecture is shown in Figure 42.

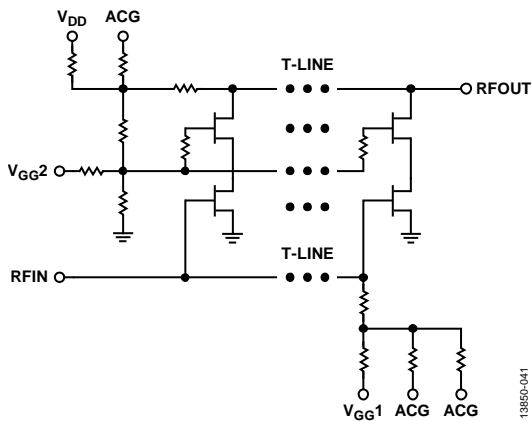

Figure 42. Architecture and Simplified Schematic

Though the gate bias voltages of the upper FETs are set internally by a resistive voltage divider tapped off of V_{DD} , the V_{GG2} pad is provided to allow the user an optional means of changing the gate bias of the upper FETs. Adjustment of the V_{GG2} voltage across the range from -2 V through $+2.4$ V changes the gate bias of the upper FETs, thus affecting gain changes of approximately 4 dB, depending on frequency. Increasing the voltage applied to V_{GG2} increases the gain, while decreasing the voltage decreases the gain. For the nominal $V_{DD} = 7.5$ V, the resulting V_{GG2} open circuit voltage is approximately 2.06 V.

A voltage applied to the V_{GG1} pad sets the gate bias of the lower FETs, providing control of the drain current. Unlike the upper FETs, a gate bias voltage for the lower FETs is not generated internally. For this reason, the application of a bias voltage to the V_{GG1} pad is required and not optional.

To operate the HMC8401 at voltages lower than the nominal 7.5 V, use a bias tee to apply 5.25 V to the drain via the RFOUT pad.

When using this alternate bias configuration, leave the V_{DD} pad open and adjust V_{GG1} to obtain a nominal quiescent $I_{DD} = 60$ mA.

Though data taken using the alternate bias configuration is not presented on this data sheet, the resulting performance differs only slightly from that obtained using the typical bias configuration. The small signal gain is a few tenths of dB greater, the compression characteristics are slightly harder, and the noise figure characteristics remain mostly unchanged.

For additional information regarding this alternate bias configuration, contact Analog Devices Applications.

APPLICATIONS INFORMATION

BIASING PROCEDURES

Capacitive bypassing is required for V_{DD} and V_{GG1} , as shown in the typical application circuit in Figure 44. Gain control is possible through the application of a dc voltage to V_{GG2} . If gain control is used, then V_{GG2} must be bypassed by 100 pF, 0.1 μ F, and 4.7 μ F capacitors. If gain control is not used, then V_{GG2} can be either left open or capacitively bypassed as described.

The recommended bias sequence during power-up is as follows:

1. Set V_{GG1} to -2.0 V to pinch off the channels of the lower FETs.
2. Set V_{DD} to 7.5 V. Because the lower FETs are pinched off, I_{DQ} remains very low upon application of V_{DD} .
3. Adjust V_{GG1} to be more positive until the desired quiescent drain current is obtained.
4. Apply the RF input signal.
5. If the gain control function is to be used, apply to V_{GG2} a voltage within the range of -2.0 V to $+2.4$ V until the desired gain is achieved.

Use of the V_{GG2} (the gain control function) affects the drain current.

The recommended bias sequence during power-down is as follows:

1. Turn off the RF input signal.
2. Remove the V_{GG2} voltage or set it to 0 V.
3. Set V_{GG1} to -2.0 V to pinch off the channels of the lower FETs.
4. Set V_{DD} to 0 V.
5. Set V_{GG1} to 0 V.

Power-up and power-down sequences may differ from the ones described, though care must always be taken to ensure adherence to the values shown in the Absolute Maximum Ratings.

Unless otherwise noted, all measurements and data shown were taken using the typical application circuit (see Figure 44), configured as shown on the assembly diagram (see Figure 45) and biased per the conditions in this section. The bias conditions shown in this section are the operating points recommended to optimize the overall performance. Operation using other bias conditions may provide performance that differs from what is shown in this data sheet. To obtain the best performance while not damaging the device, follow the recommended biasing sequence outlined in this section.

MOUNTING AND BONDING TECHNIQUES FOR MILLIMETERWAVE GaAs MMICs

Attach the die directly to the ground plane eutectically or with conductive epoxy. To bring RF to and from the chip, use 50 Ω microstrip transmission lines on 0.127 mm (5 mil) thick alumina thin film substrates (see Figure 43).

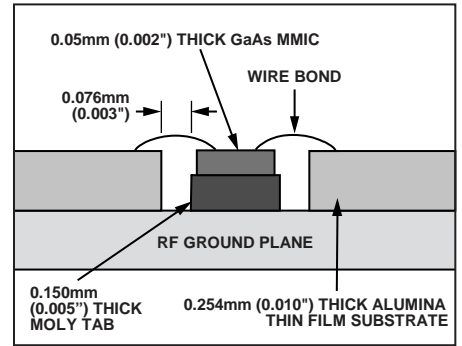

Figure 43. Routing RF Signals with Molytab

To minimize bond wire length, place microstrip substrates as close to the die as possible. Typical die to substrate spacing is 0.076 mm to 0.152 mm (3 mil to 6 mil).

Handling Precautions

To avoid permanent damage, adhere to the following precautions:

- All bare die ship in either wafer or gel-based ESD protective containers, sealed in an ESD protective bag. After the sealed ESD protective bag is opened, store all die in a dry nitrogen environment.
- Handle the chips in a clean environment. Never use liquid cleaning systems to clean the chip.
- Follow ESD precautions to protect against ESD strikes.
- While bias is applied, suppress instrument and bias supply transients. To minimize inductive pickup, use shielded signal and bias cables.
- Handle the chip along the edges with a vacuum collet or with a sharp pair of bent tweezers. The surface of the chip may have fragile air bridges and must not be touched with vacuum collet, tweezers, or fingers.

Mounting

The chip is back metallized and can be die mounted with gold/tin (AuSn) eutectic preforms or with electrically conductive epoxy. The mounting surface must be clean and flat.

Eutectic Die Attach

It is best to use an 80% gold/20% tin preform with a work surface temperature of 255°C and a tool temperature of 265°C. When hot 90% nitrogen/10% hydrogen gas is applied, maintain tool tip temperature at 290°C. Do not expose the chip to a temperature greater than 320°C for more than 20 sec. No more than 3 sec of scrubbing is required for attachment.

Epoxy Die Attach

ABLETHERM 2600BT is recommended for die attachment. Apply a minimum amount of epoxy to the mounting surface so that a thin epoxy fillet is observed around the perimeter of the chip after placing it into position. Cure the epoxy per the schedule provided by the manufacturer.

Wire Bonding

RF bonds made with 0.003 in. × 0.0005 in. gold ribbon are recommended for the RF ports. These bonds must be thermosonically bonded with a force of 40 g to 60 g. DC bonds of 1 mil (0.025 mm) diameter, thermosonically bonded, are recommended.

Create ball bonds with a force of 40 g to 50 g and wedge bonds with a force of 18 g to 22 g. Create all bonds with a nominal stage temperature of 150°C. Apply a minimum amount of ultrasonic energy to achieve reliable bonds. Keep all bonds as short as possible, less than 12 mil (0.31 mm).

TYPICAL APPLICATION CIRCUIT

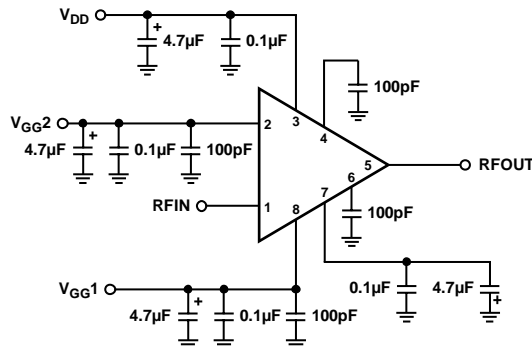

Figure 44. Typical Application Circuit

ASSEMBLY DIAGRAM

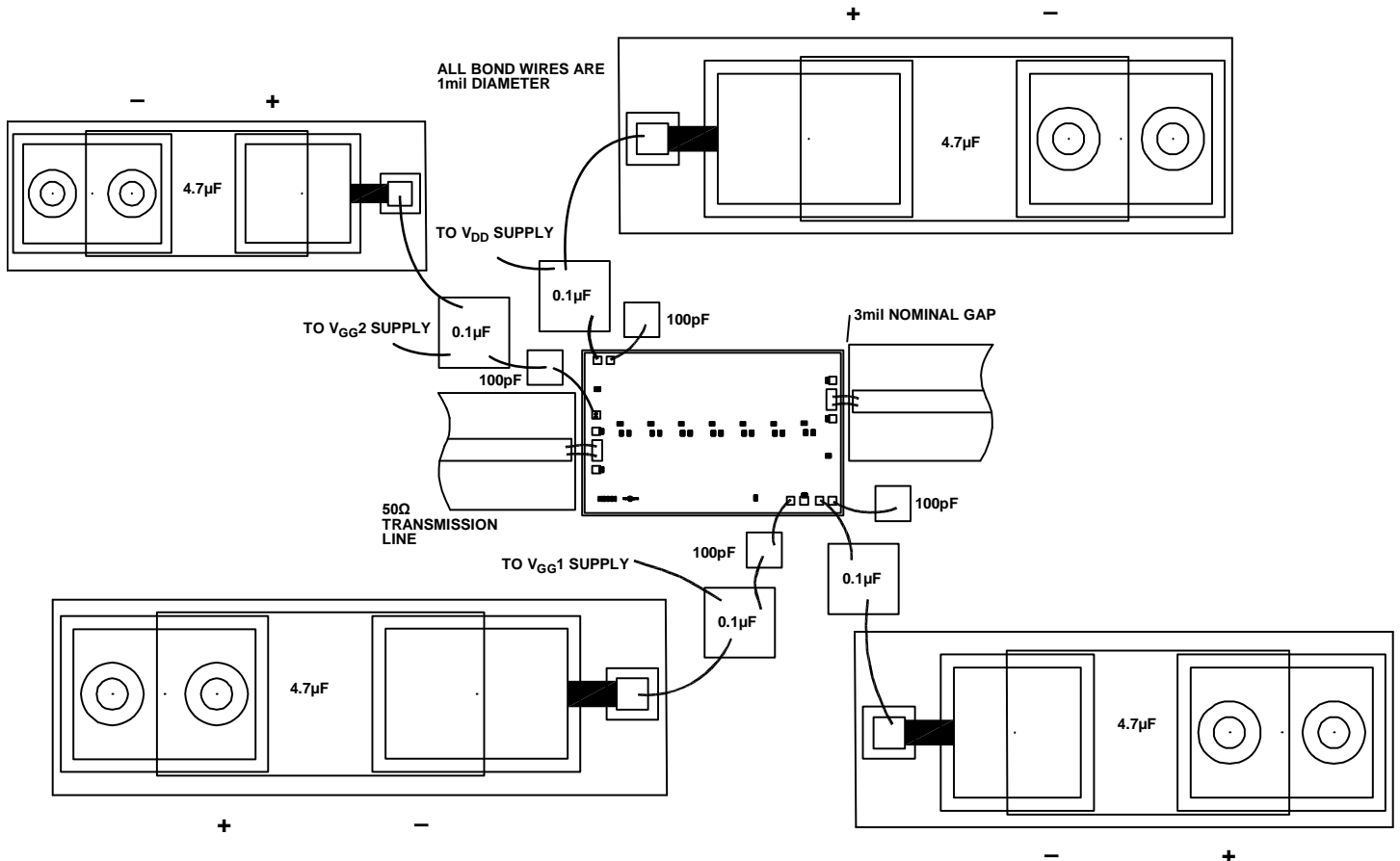

Figure 45. Assembly Diagram

OUTLINE DIMENSIONS

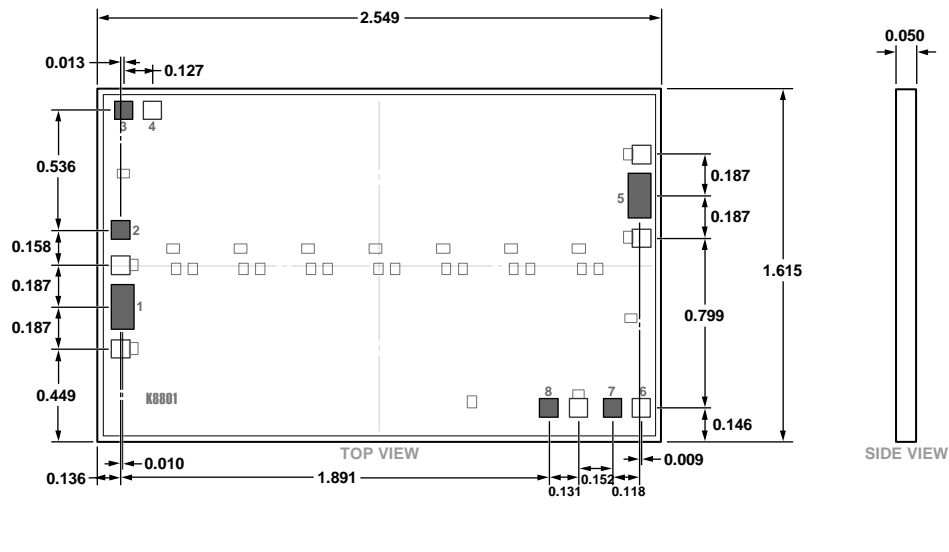

Figure 46. 8-Pad Bare Die [CHIP]
(C-8-8)
Dimensions shown in millimeters

ORDERING GUIDE

Model ^{1, 2}	Temperature Range	Package Description	Package Option
HMC8401	-55°C to +85°C	8-Pad Bare Die [CHIP]	C-8-8
HMC8401-SX	-55°C to +85°C	8-Pad Bare Die [CHIP]	C-8-8

¹ The HMC8401-SX is a sample order of two devices.

² All models are RoHS compliant parts.