

FEATURES

- Single positive supply: 5 V at 97 mA
- Conversion loss: 10 dB typical at 24 GHz to 30 GHz,
10.5 dB typical at 30 GHz to 34 GHz (upconverter)
- Input IP3: 17.5 dBm typical at 24 GHz to 30 GHz,
20 dBm typical at 30 GHz to 34 GHz (upconverter)
- 2 × LO to RF isolation: 36 dB typical at 30 GHz to 34 GHz
- Wide IF bandwidth: dc to 4 GHz
- LO drive level: 4 dBm input
- Subharmonically pumped 2 × LO
- RoHS compliant, 24-terminal, 3.90 mm × 3.90 mm, ceramic LCC package

APPLICATIONS

- Microwave and very small aperture terminal (VSAT) radios
- Test equipment
- Point to point radios
- Satellite communications (SATCOM)
- Military electronic warfare (EW), electronic countermeasure (ECM), and command, control, communications and intelligence (C3I)

GENERAL DESCRIPTION

The HMC798ALC4 is a 24 GHz to 34 GHz subharmonically pumped (×2) MMIC mixer with an integrated LO amplifier housed in a leadless, RoHS compliant LCC package. The HMC798ALC4 can be used as an upconverter or downconverter between 24 GHz and 34 GHz.

The 2 × LO to radio frequency (RF) isolation is typically 30 dB in a 24 GHz to 30 GHz frequency range and 36 dB in a 30 GHz

FUNCTIONAL BLOCK DIAGRAM

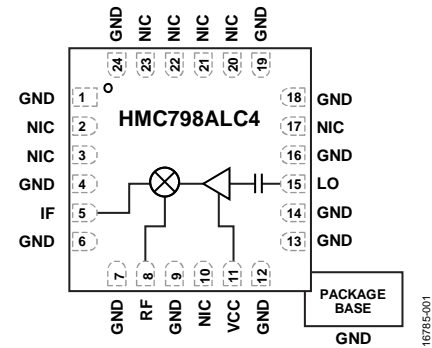

Figure 1.

to 34 GHz frequency range, eliminating the need for additional filtering. The LO amplifier is single bias at a 5 V dc with a typical 4 dBm LO drive level requirement. The HMC798ALC4 eliminates the need for wire bonding, allowing use of surface-mount technology (SMT) manufacturing techniques.

TABLE OF CONTENTS

Features	1	Downconverter Performance	10
Applications.....	1	Isolation and Return Loss	18
Functional Block Diagram	1	IF Bandwidth—Downconverter, Upper Sideband.....	20
General Description	1	IF Bandwidth—Downconverter, Lower Sideband.....	21
Revision History	2	Spurious and Harmonics Performance	22
Specifications.....	3	Theory of Operation	23
Absolute Maximum Ratings.....	4	Applications Information	24
Thermal Resistance	4	Typical Application Circuit.....	24
ESD Caution.....	4	Evaluation PCB Information	24
Pin Configuration and Function Descriptions.....	5	Soldering Information and Recommended Land Pattern	24
Interface Schematics.....	5	Outline Dimensions	26
Typical Performance Characteristics	6	Ordering Guide	26
Upconverter Performance	6		

REVISION HISTORY

6/2018—Revision 0: Initial Version

SPECIFICATIONS

$V_{CC} = 5\text{ V}$, $T_A = 25^\circ\text{C}$, upconverter (IF_{IN}) = 1 GHz at -10 dBm , LO = 4 dBm, upper side band. All measurements performed as an upconverter, unless otherwise noted, on the evaluation printed circuit board (PCB).

Table 1.

Parameter	Symbol	Test Conditions/Comments	Min	Typ	Max	Unit
FREQUENCY RANGE						
RF			24		34	GHz
LO Input			12		18	GHz
IF			DC		4	GHz
SUPPLY CURRENT	I_{CC}			97	125	mA
SUPPLY VOLTAGE	V_{CC}		4.75	5	5.25	V
LO DRIVE LEVELS			0	4	6	dBm
24 GHz to 30 GHz PERFORMANCE						
Upconverter	IF_{IN}					
Conversion Loss				10	12.5	dB
Input Third-Order Intercept	IP3		12.5	17.5		dBm
Input 1 dB Compression Point	P1dB			6		dBm
Downconverter	IF					
Conversion Loss				11		dB
Input Third-Order Intercept	IP3			23		dBm
Input Second-Order Intercept	IP2			50		dBm
Input 1 dB Compression Point	P1dB			14		dBm
Isolation						
RF to IF				30		dB
$2 \times$ LO to RF			22	31		dB
$2 \times$ LO to IF				26.5		dB
30 GHz to 34 GHz PERFORMANCE						
Upconverter	IF_{IN}					
Conversion Loss				10.5	13.5	dB
Input Third-Order Intercept	IP3		15	20		dBm
Input 1 dB Compression Point	P1dB			9		dBm
Downconverter	IF					
Conversion Loss				10.5		dB
Input Third-Order Intercept	IP3			25		dBm
Input Second-Order Intercept	IP2			43		dBm
Input 1 dB Compression Point	P1dB			15		dBm
Isolation						
RF to IF				32		dB
$2 \times$ LO to RF			25	36		dB
$2 \times$ LO to IF				27		dB

ABSOLUTE MAXIMUM RATINGS

Table 2.

Parameter	Rating
RF Input Power	13 dBm
LO Input Power	10 dBm
IF Input Power	13 dBm
IF Source or Sink Current	3 mA
V _{CC} Supply Voltage	5.5 V
Peak Reflow Temperature	260°C
Maximum Junction Temperature (T _J)	175°C
Lifetime at Maximum (T _J)	1 × 10 ⁶ hrs
Moisture Sensitivity Level (MSL) ¹	MSL3
Continuous Power Dissipation, P _{DISS} (T _A = 85°C, Derate 8.33 mW/°C Above 85°C)	750 mW
Operating Temperature Range	–40°C to +85°C
Storage Temperature Range	–65°C to +150°C
Lead Temperature Range	–65°C to +150°C
Electrostatic Discharge (ESD) Sensitivity	
Human Body Model (HBM)	250 V
Field Induced Charged Device Model (FICDM)	250 V

¹ Based on IPC/JEDEC J-STD-20 MSL classifications.

Stresses at or above those listed under Absolute Maximum Ratings may cause permanent damage to the product. This is a stress rating only; functional operation of the product at these or any other conditions above those indicated in the operational section of this specification is not implied. Operation beyond the maximum operating conditions for extended periods may affect product reliability.

THERMAL RESISTANCE

Thermal performance is directly linked to printed circuit board (PCB) design and operating environment. Careful attention to PCB thermal design is required.

θ_{JA} is the natural convection junction to ambient thermal resistance measured in a one cubic foot sealed enclosure. θ_{JC} is the junction to case thermal resistance.

Table 3. Thermal Resistance

Package Type	θ_{JA}	θ_{JC}	Unit
E-24-1 ¹	120	119	°C/W

¹ See JEDEC Standard JESD51-2 for additional information on optimizing the thermal impedance (PCB with 3 × 3 vias).

ESD CAUTION



ESD (electrostatic discharge) sensitive device. Charged devices and circuit boards can discharge without detection. Although this product features patented or proprietary protection circuitry, damage may occur on devices subjected to high energy ESD. Therefore, proper ESD precautions should be taken to avoid performance degradation or loss of functionality.

PIN CONFIGURATION AND FUNCTION DESCRIPTIONS

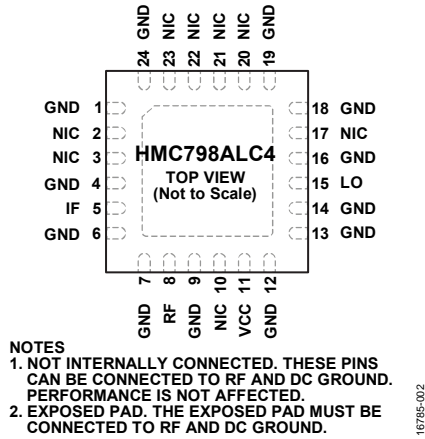

Figure 2. Pin Configuration

Table 4. Pin Function Descriptions

Pin No.	Mnemonic	Description
1, 4, 6, 7, 9, 12, 13, 14, 16, 18, 19, 24	GND	Ground. These pins and package bottom must be connected to RF and dc ground.
2, 3, 10, 17, 20, 21, 22, 23	NIC	Not Internally Connected. These pins can be connected to RF and dc ground. Performance is not affected.
5	IF	Intermediate Frequency Port. This pin is dc-coupled. For applications not requiring operation to dc, dc block this port externally using a series capacitor of a value chosen to pass the necessary IF frequency range. For operation to dc, this pin must not source or sink more than 3 mA of current or die malfunction and possible die failure may result.
8	RF	Radio Frequency Port. This pin is dc-coupled and matched to 50 Ω.
11	V _{CC}	Power Supply for the LO Amplifier.
15	LO	Local Oscillator Port. This pin is ac-coupled and matched to 50 Ω.
25	EPAD	Exposed Pad. The exposed pad must be connected to RF and dc ground.

INTERFACE SCHEMATICS



Figure 3. GND Interface Schematic

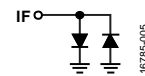

Figure 5. IF Interface Schematic

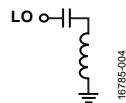

Figure 4. LO Interface Schematic

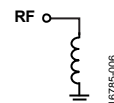

Figure 6. RF Interface Schematic

TYPICAL PERFORMANCE CHARACTERISTICS

UPCONVERTER PERFORMANCE

$IF_{IN} = 1 \text{ GHz}$, Upper Sideband

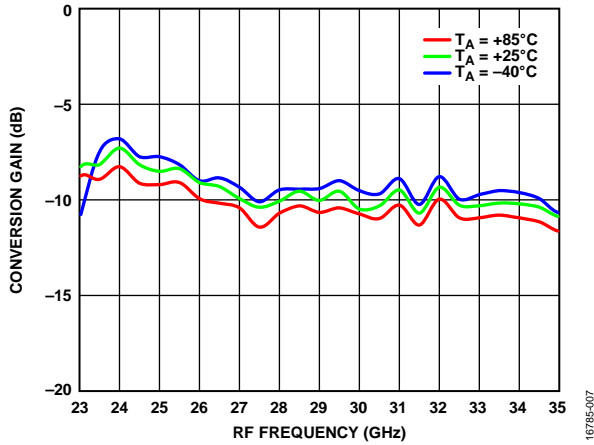

Figure 7. Conversion Gain vs. RF Frequency at Various Temperatures, LO = 4 dBm



Figure 10. Conversion Gain vs. RF Frequency at Various LO Power Levels, $T_A = 25^\circ\text{C}$

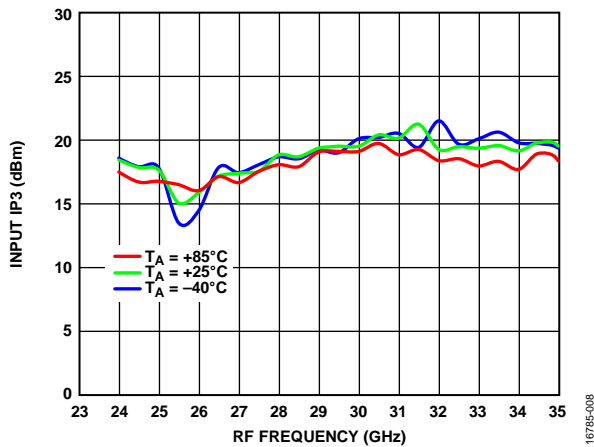

Figure 8. Input IP3 vs. RF Frequency at Various Temperatures, LO = 4 dBm



Figure 11. Input IP3 vs. RF Frequency at Various LO Power Levels, $T_A = 25^\circ\text{C}$

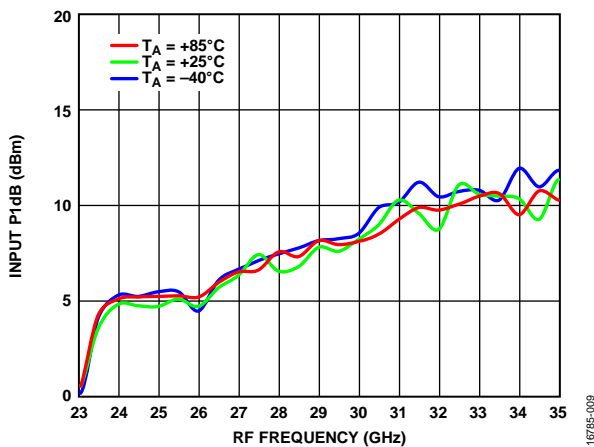

Figure 9. Input P1dB vs. RF Frequency at Various Temperatures, LO = 4 dBm

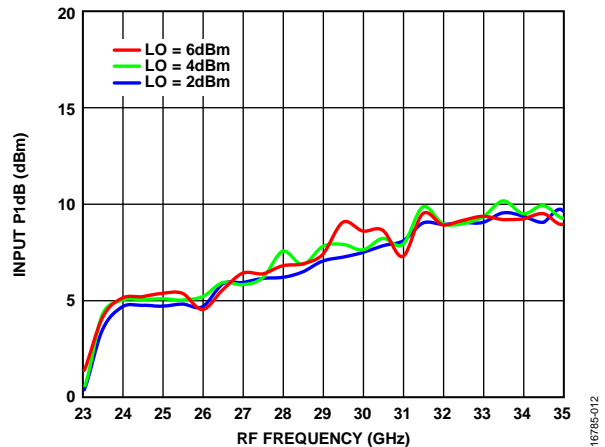

Figure 12. Input P1dB vs. RF Frequency at Various LO Power Levels, $T_A = 25^\circ\text{C}$

$IF_{IN} = 1$ GHz, Lower Sideband

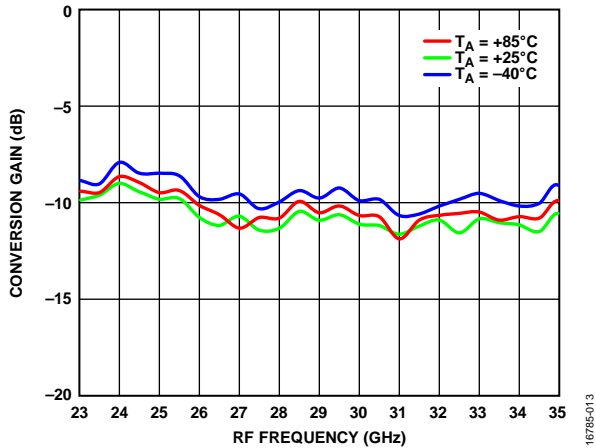

Figure 13. Conversion Gain vs. RF Frequency at Various Temperatures, LO = 4 dBm

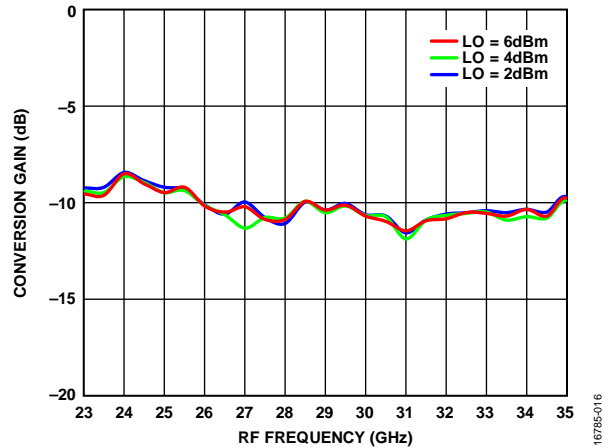

Figure 16. Conversion Gain vs. RF Frequency at Various LO Power Levels, $T_A = 25^\circ\text{C}$

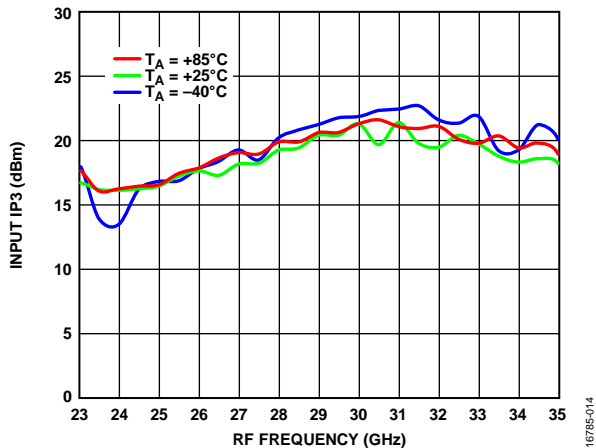

Figure 14. Input IP3 vs. RF Frequency at Various Temperatures, LO = 4 dBm

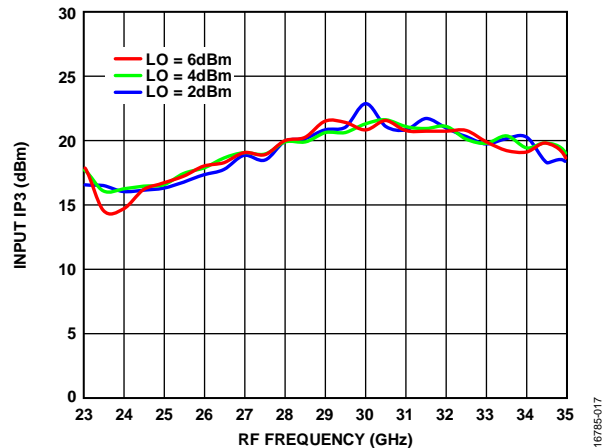

Figure 17. Input IP3 vs. RF Frequency at Various LO Power Levels, $T_A = 25^\circ\text{C}$

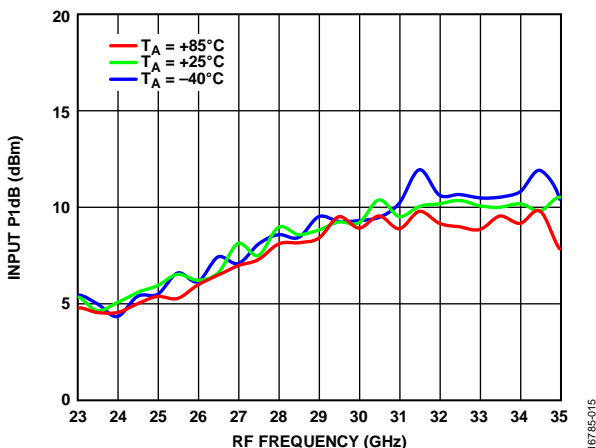

Figure 15. Input P1dB vs. RF Frequency at Various Temperatures, LO = 4 dBm

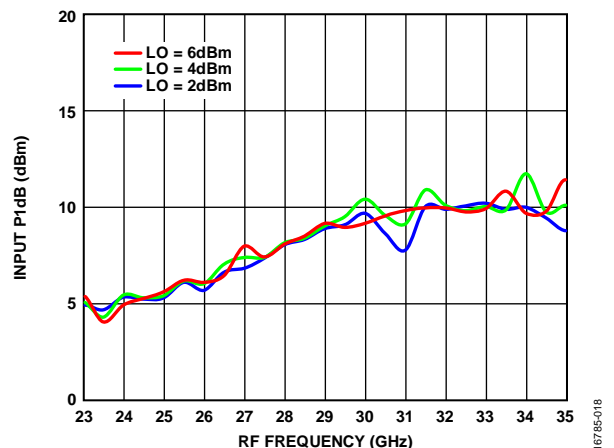

Figure 18. Input P1dB vs. RF Frequency at Various LO Power Levels, $T_A = 25^\circ\text{C}$

$IF_{IN} = 3.75 \text{ GHz}$, Upper Sideband



Figure 19. Conversion Gain vs. RF Frequency at Various Temperatures, LO = 4 dBm



Figure 22. Conversion Gain vs. RF Frequency at Various LO Power Levels, $T_A = 25^\circ\text{C}$

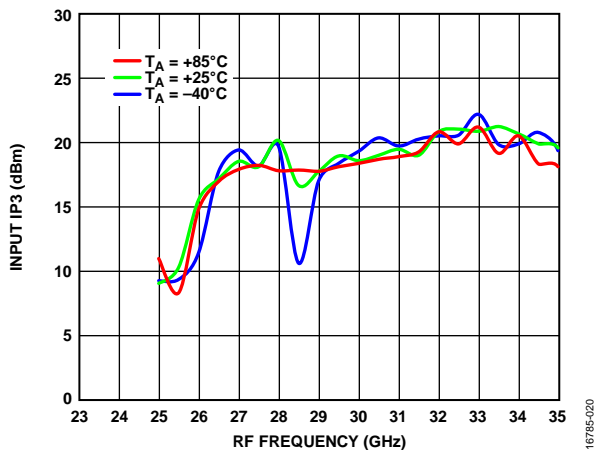

Figure 20. Input IP3 vs. RF Frequency at Various Temperatures, LO = 4 dBm

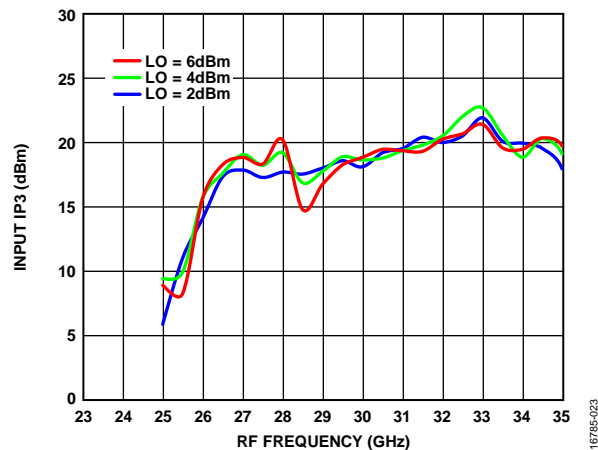

Figure 23. Input IP3 vs. RF Frequency at Various LO Power Levels, $T_A = 25^\circ\text{C}$

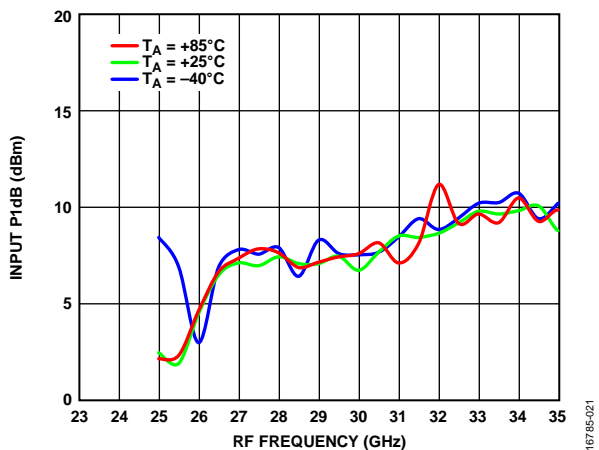

Figure 21. Input P1dB vs. RF Frequency at Various Temperatures, LO = 4 dBm

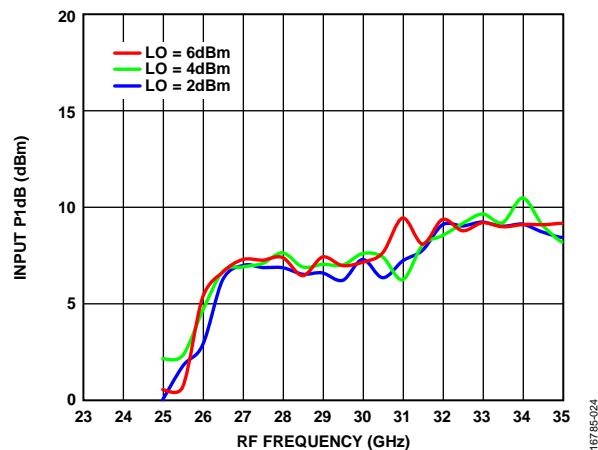

Figure 24. Input P1dB vs. RF Frequency at Various LO Power Levels, $T_A = 25^\circ\text{C}$

$I_{F_{IN}} = 3.75 \text{ GHz, Lower Sideband}$

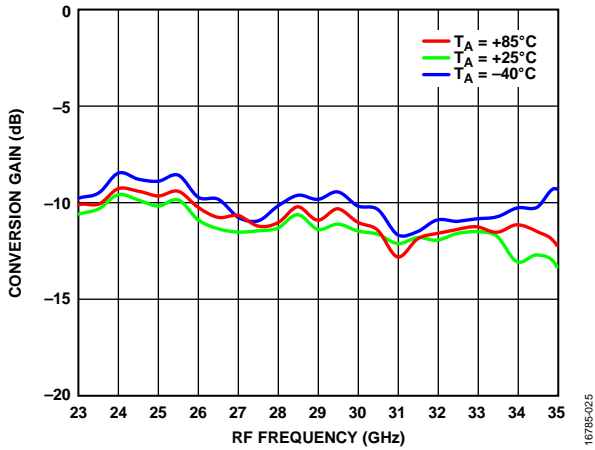

Figure 25. Conversion Gain vs. RF Frequency at Various Temperatures, LO = 4 dBm

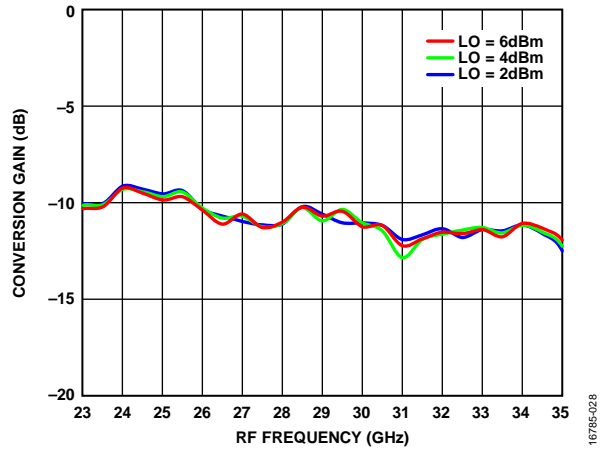

Figure 28. Conversion Gain vs. RF Frequency at Various LO Power Levels, $T_A = 25^\circ\text{C}$

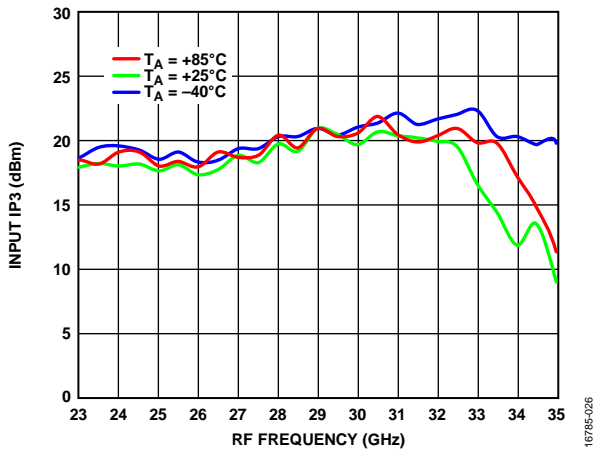

Figure 26. Input IP3 vs. RF Frequency at Various Temperatures, LO = 4 dBm

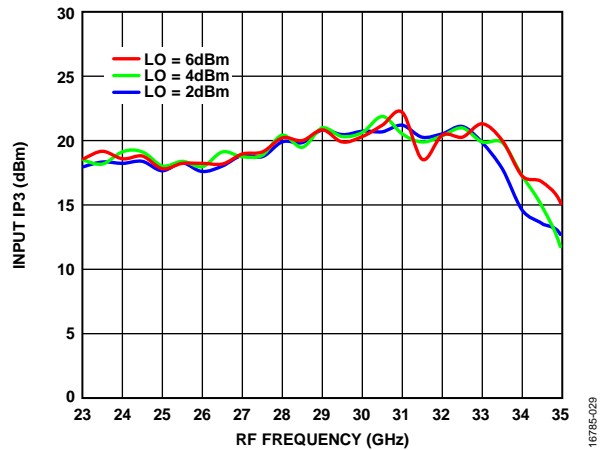

Figure 29. Input IP3 vs. RF Frequency at Various LO Power Levels, $T_A = 25^\circ\text{C}$

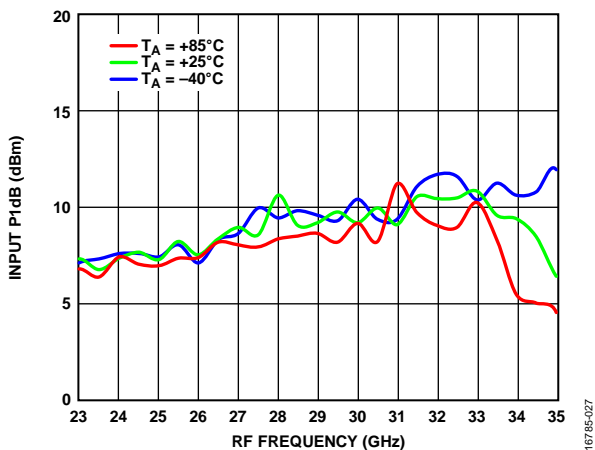

Figure 27. Input P1dB vs. RF Frequency at Various Temperatures, LO = 4 dBm

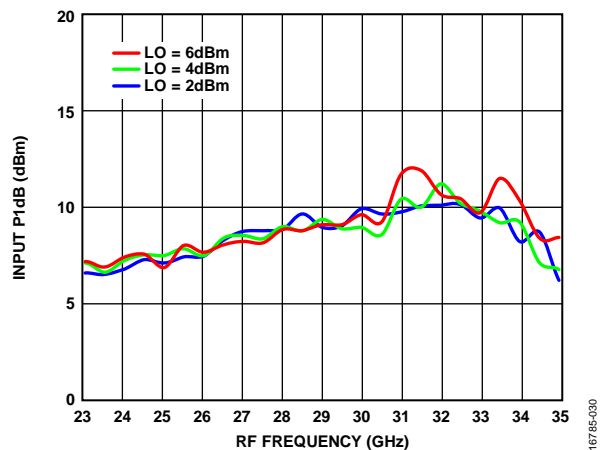

Figure 30. Input P1dB vs. RF Frequency at Various LO Power Levels, $T_A = 25^\circ\text{C}$

DOWNCONVERTER PERFORMANCE

IF = 1 GHz, Upper Sideband (Low-Side LO)



Figure 31. Conversion Gain vs. RF Frequency at Various Temperatures, LO = 4 dBm



Figure 33. Conversion Gain vs. RF Frequency at Various LO Power Levels, $T_A = 25^\circ\text{C}$



Figure 32. Input IP3 vs. RF Frequency at Various Temperatures, LO = 4 dBm



Figure 34. Input IP3 vs. RF Frequency at Various LO Power Levels, $T_A = 25^\circ\text{C}$

Downconverter IP2 and P1dB, Upper Sideband (Low-Side LO)

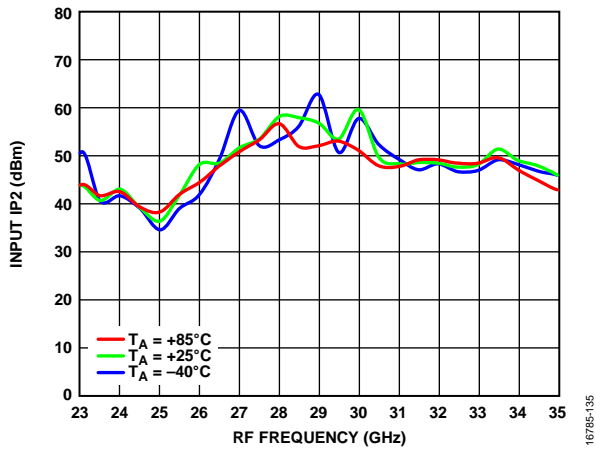

Figure 35. Input IP2 vs. RF Frequency at Various Temperatures, LO = 4 dBm

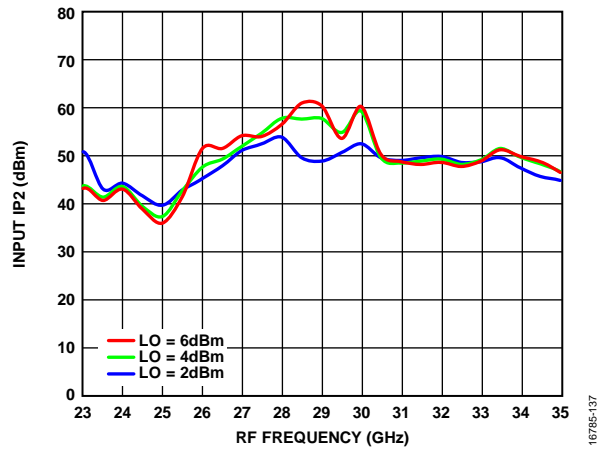

Figure 37. Input IP2 vs. RF Frequency at Various LO Power Levels, TA = 25°C

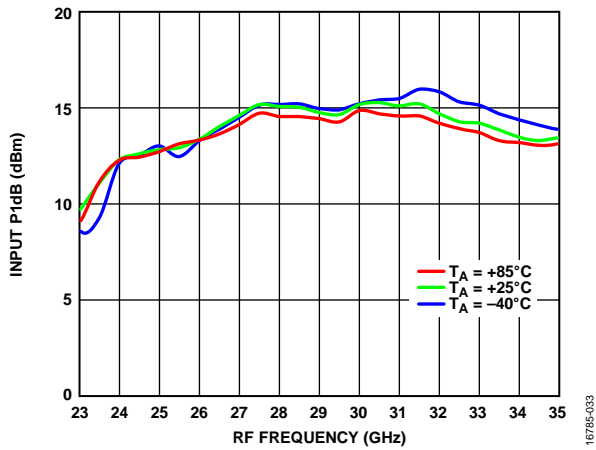

Figure 36. Input P1dB vs. RF Frequency at Various Temperatures, LO = 4 dBm

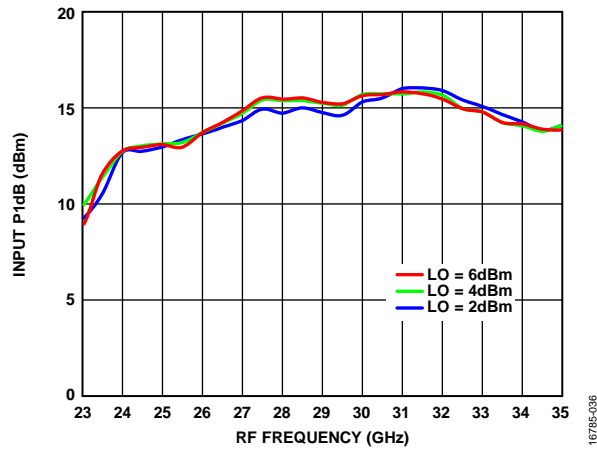

Figure 38. Input P1dB vs. RF Frequency at Various LO Power Levels, TA = 25°C

IF = 1 GHz, Lower Sideband (High-Side LO)

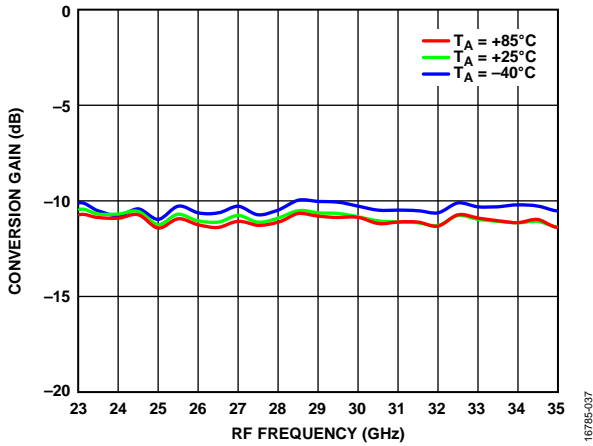

Figure 39. Conversion Gain vs. RF Frequency at Various Temperatures, LO = 4 dBm

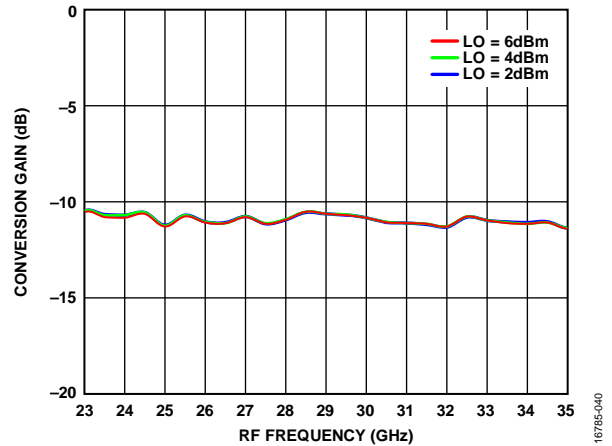

Figure 41. Conversion Gain vs. RF Frequency at Various LO Power Levels, $T_A = 25^\circ\text{C}$

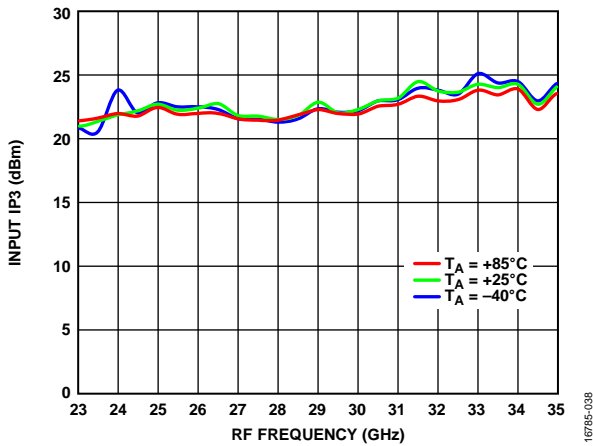

Figure 40. Input IP3 vs. RF Frequency at Various Temperatures, LO = 4 dBm

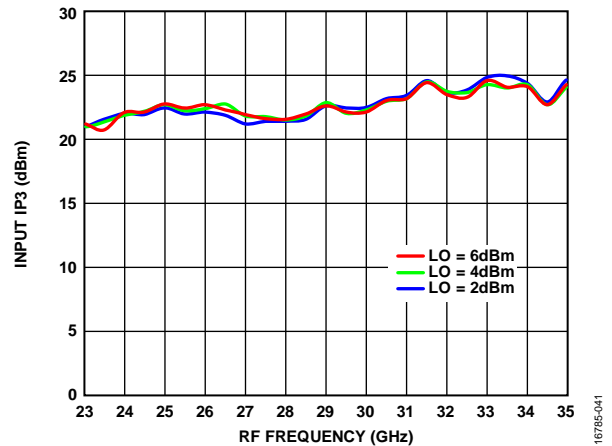

Figure 42. Input IP3 vs. RF Frequency at Various LO Power Levels, $T_A = 25^\circ\text{C}$

Downconverter IP2 and P1dB, Lower Sideband (High-Side LO)

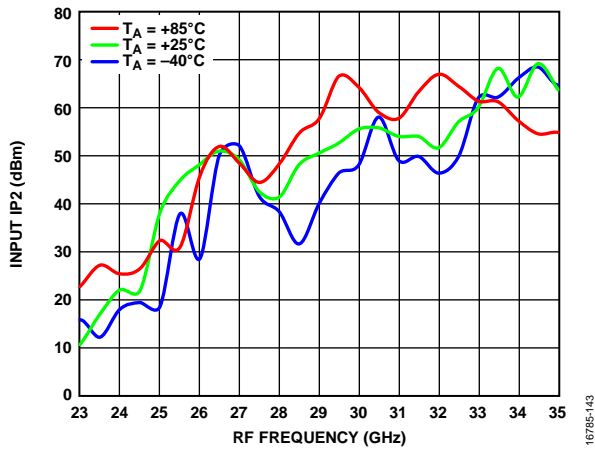

Figure 43. Input IP2 vs. RF Frequency at Various Temperatures, LO = 4 dBm

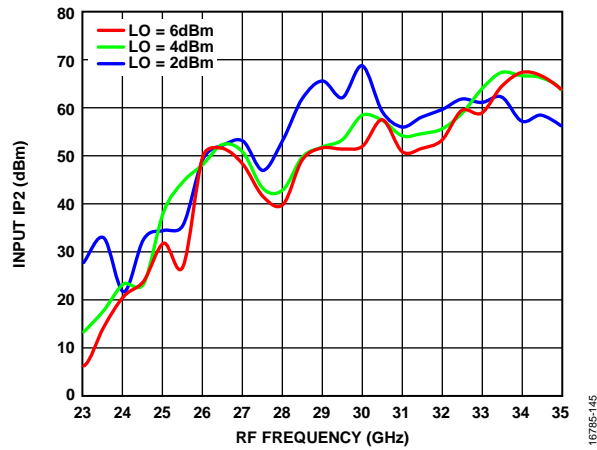

Figure 45. Input IP2 vs. RF Frequency at Various LO Power Levels, TA = 25°C

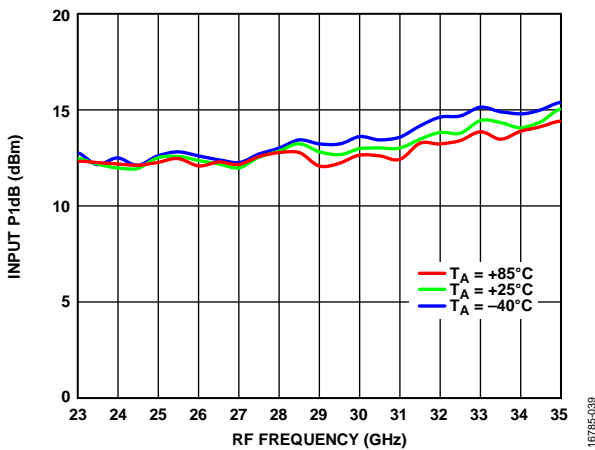

Figure 44. Input P1dB vs. RF Frequency at Various Temperatures, LO = 4 dBm

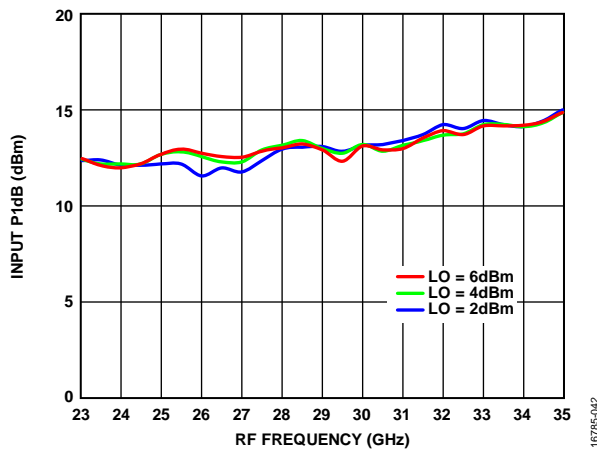

Figure 46. Input P1dB vs. RF Frequency at Various LO Power Levels, TA = 25°C

IF = 3.75 GHz, Upper Sideband (Low-Side LO)



Figure 47. Conversion Gain vs. RF Frequency at Various Temperatures, LO = 4 dBm

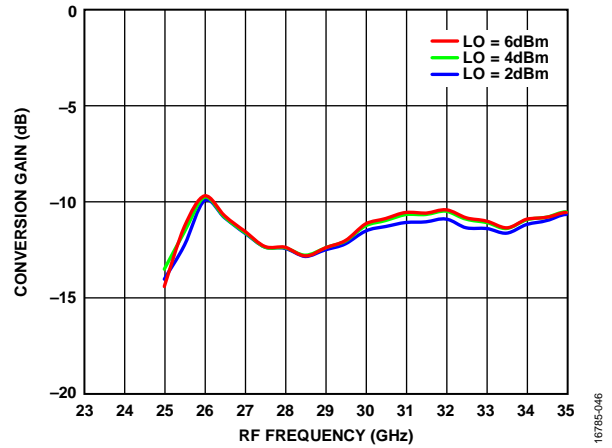

Figure 49. Conversion Gain vs. RF Frequency at Various LO Power Levels, $T_A = 25^\circ\text{C}$

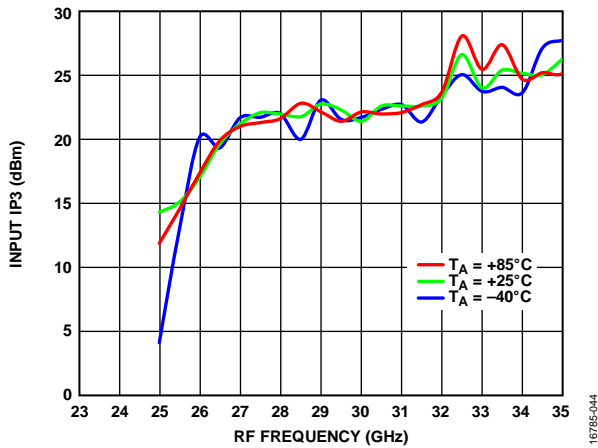

Figure 48. Input IP3 vs. RF Frequency at Various Temperatures, LO = 4 dBm

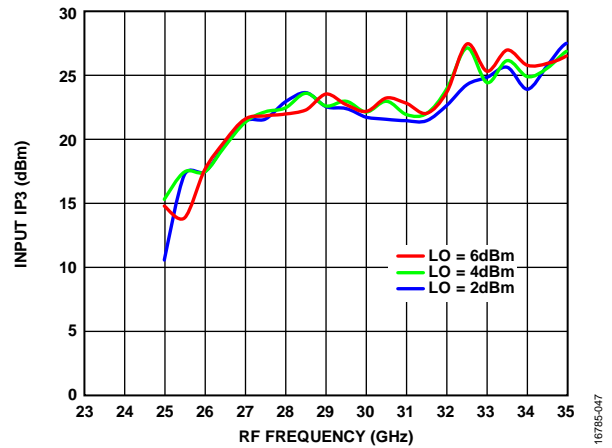

Figure 50. Input IP3 vs. RF Frequency at Various LO Power Levels, $T_A = 25^\circ\text{C}$

Downconverter IP2 and P1dB, Upper Sideband (Low-Side LO)

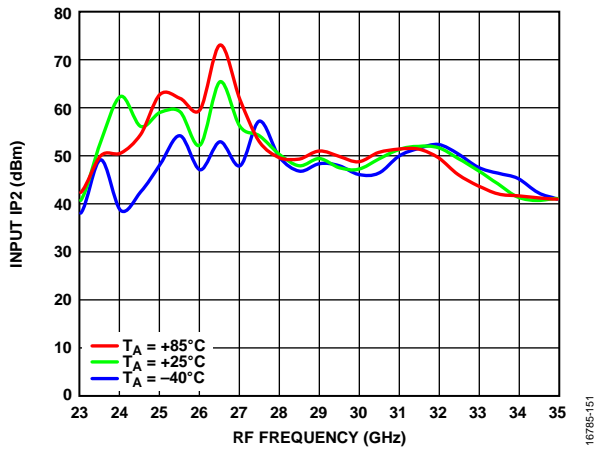

Figure 51. Input IP2 vs. RF Frequency at Various Temperatures, LO = 4 dBm



Figure 53. Input IP2 vs. RF Frequency at Various LO Power Levels, TA = 25°C

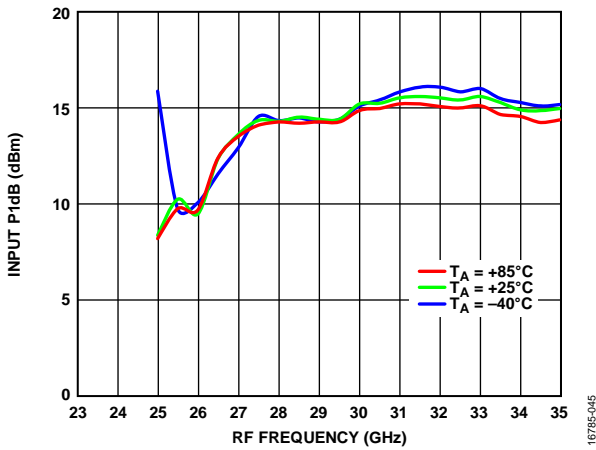

Figure 52. Input P1dB vs. RF Frequency at Various Temperatures, LO = 4 dBm

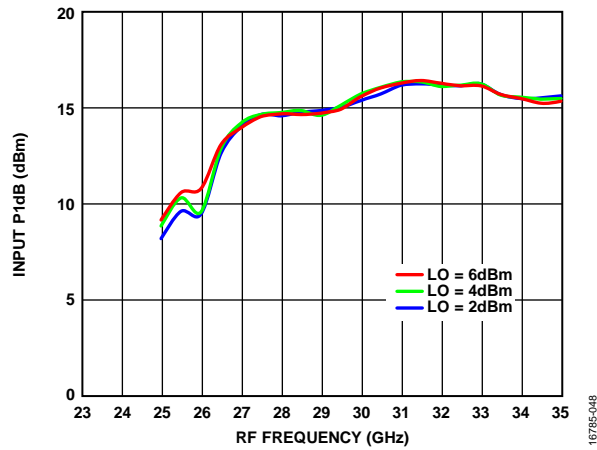

Figure 54. Input P1dB vs. RF Frequency at Various LO Power Levels, TA = 25°C

IF = 3.75 GHz, Lower Sideband (High-Side LO)

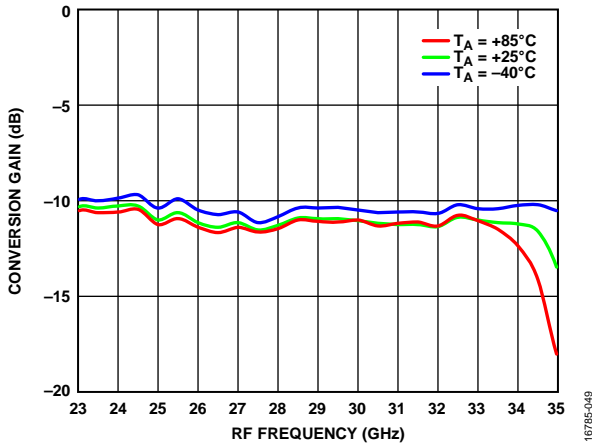

Figure 55. Conversion Gain vs. RF Frequency at Various Temperatures, LO = 4 dBm



Figure 57. Conversion Gain vs. RF Frequency at Various LO Power Levels, TA = 25°C

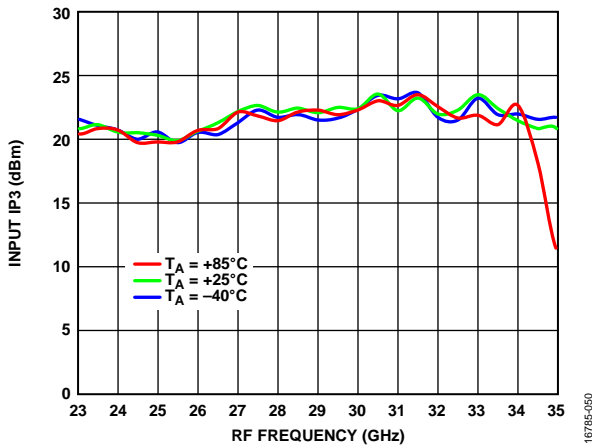

Figure 56. Input IP3 vs. RF Frequency at Various Temperatures, LO = 4 dBm

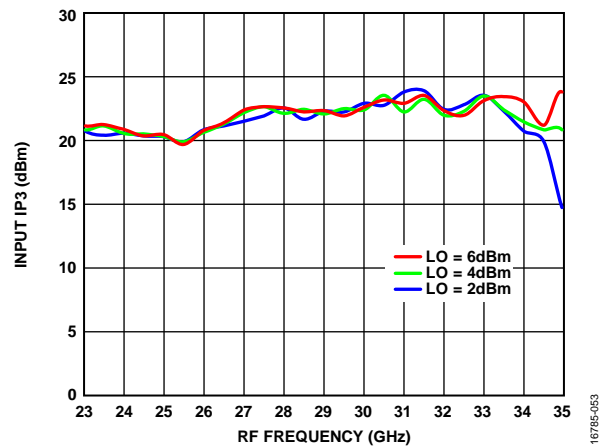

Figure 58. Input IP3 vs. RF Frequency at Various LO Power Levels, TA = 25°C

Downconverter IP2 and P1dB, Lower Sideband (High-Side LO)



Figure 59. Input IP2 vs. RF Frequency at Various Temperatures, LO = 4 dBm

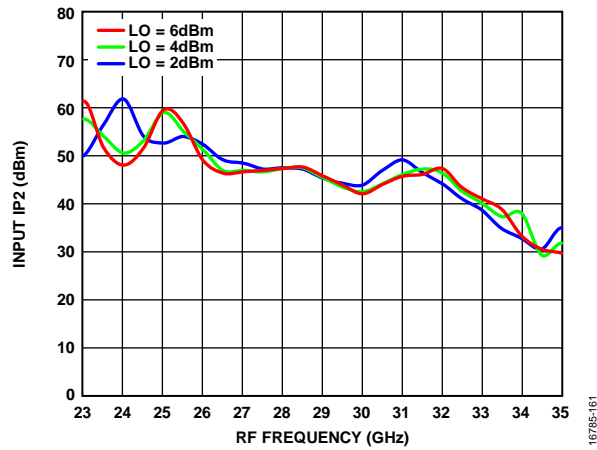

Figure 61. Input IP2 vs. RF Frequency at Various LO Power Levels, TA = 25°C

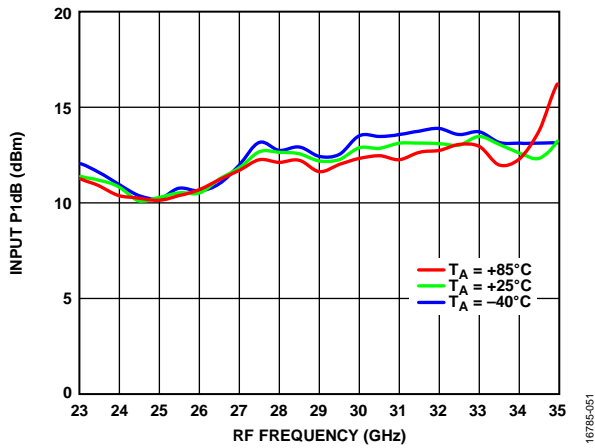

Figure 60. Input P1dB vs. RF Frequency at Various Temperatures, LO = 4 dBm

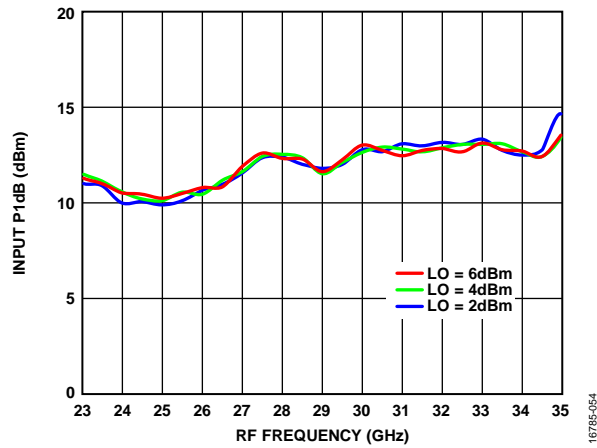

Figure 62. Input P1dB vs. RF Frequency at Various LO Power Levels, TA = 25°C

ISOLATION AND RETURN LOSS

Upconverter performance at $IF_{IN} = 1$ GHz, upper sideband.

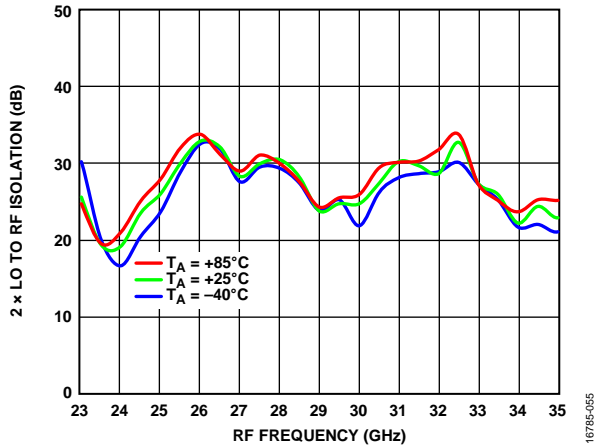

Figure 63. 2 x LO to RF Isolation vs. RF Frequency at Various Temperatures, LO = 4 dBm

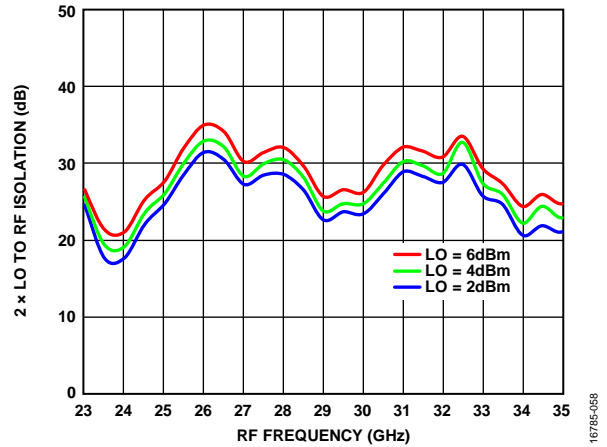

Figure 66. 2 x LO to RF Isolation vs. RF Frequency at Various LO Power Levels, $T_A = 25^\circ\text{C}$

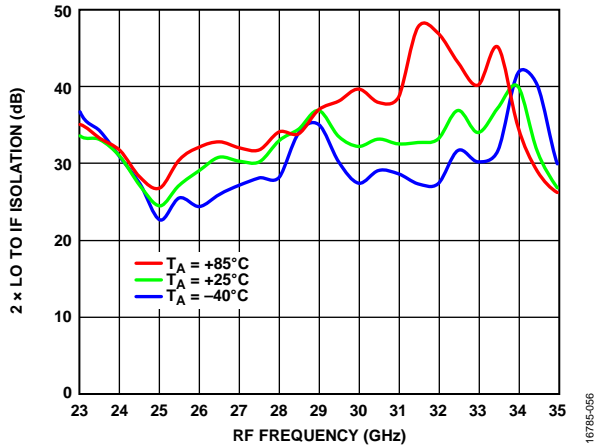

Figure 64. 2 x LO to IF Isolation vs. RF Frequency at Various Temperatures, LO = 4 dBm

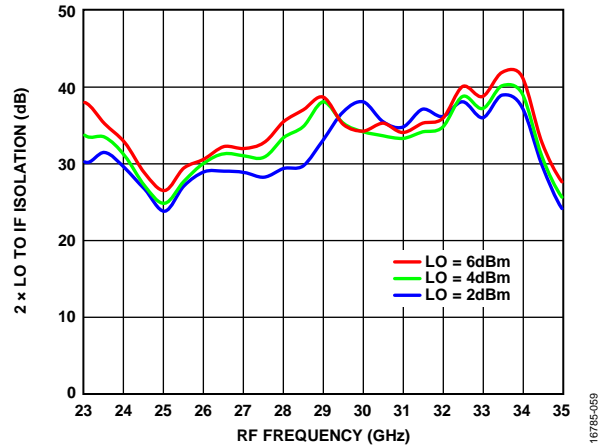

Figure 67. 2 x LO to IF Isolation vs. RF Frequency at Various LO Power Levels, $T_A = 25^\circ\text{C}$

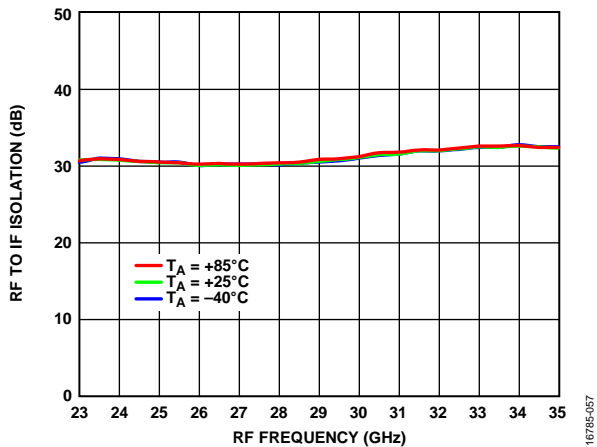

Figure 65. RF to IF Isolation vs. RF Frequency at Various Temperatures, LO = 4 dBm

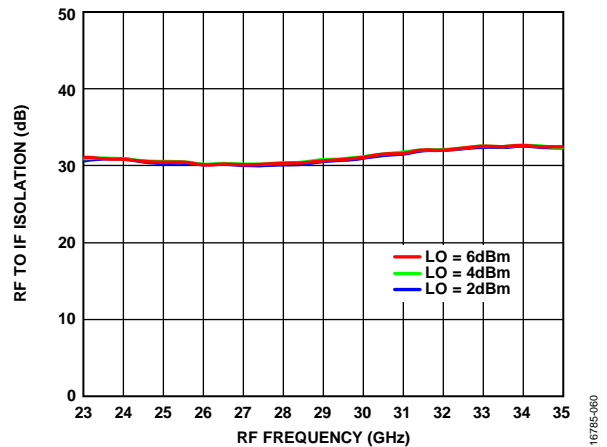

Figure 68. RF to IF Isolation vs. RF Frequency at Various LO Power Levels, $T_A = 25^\circ\text{C}$

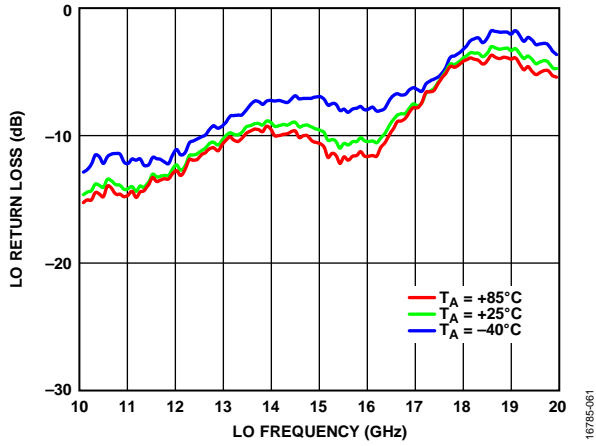

Figure 69. LO Return Loss vs. LO Frequency at Various Temperatures, LO = 4 dBm



Figure 71. IF Return Loss vs. IF Frequency at Various Temperatures, LO = 14 GHz at 4 dBm

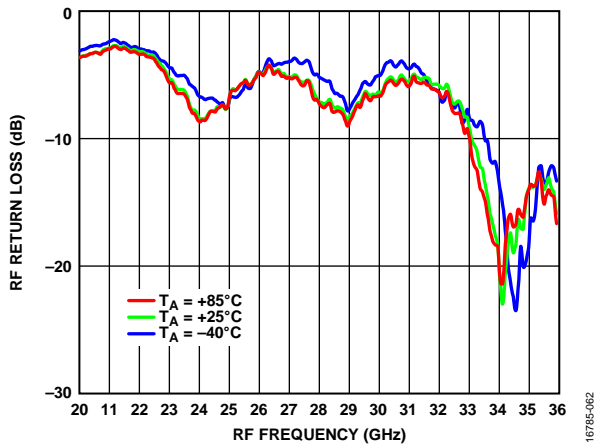

Figure 70. RF Return Loss vs. RF Frequency at Various Temperatures, LO = 14 GHz at 4 dBm

IF BANDWIDTH—DOWNCONVERTER, UPPER SIDEBAND

LO frequency = 8 GHz.

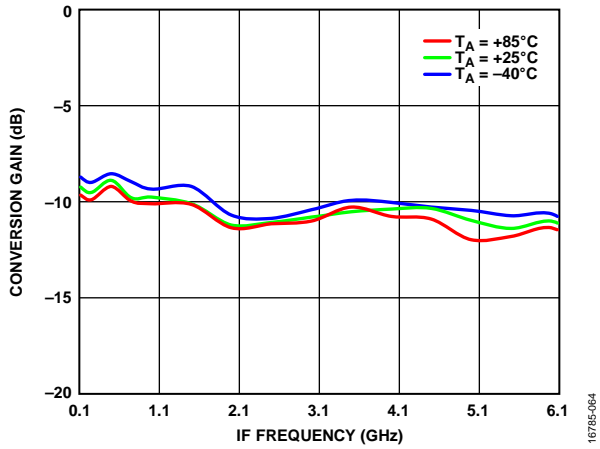

Figure 72. Conversion Gain vs. IF Frequency at Various Temperatures, LO = 4 dBm

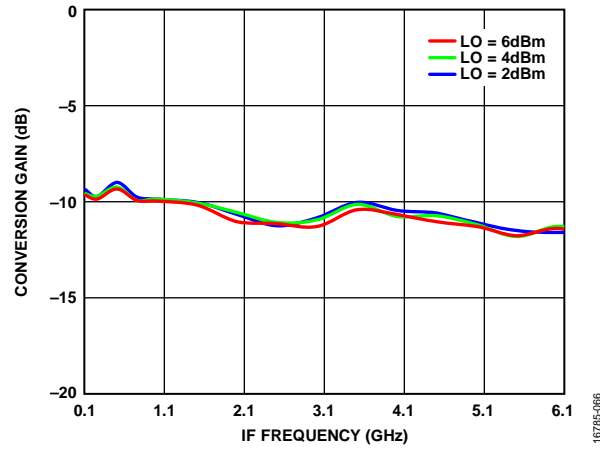

Figure 74. Conversion Gain vs. IF Frequency at Various LO Power Levels, $T_A = 25^\circ\text{C}$

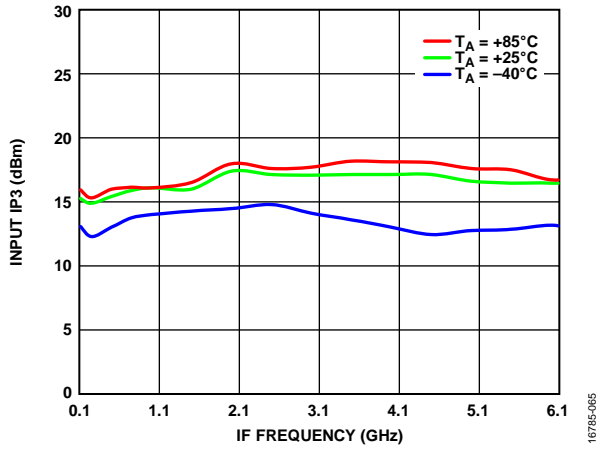

Figure 73. Input IP3 vs. IF Frequency at Various Temperatures, LO = 4 dBm

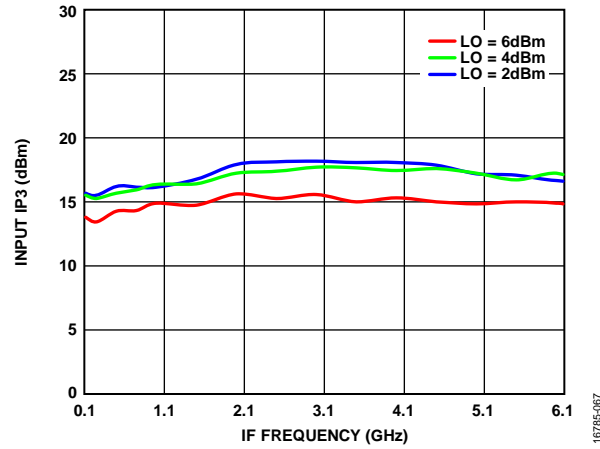

Figure 75. Input IP3 vs. IF Frequency at Various LO Power Levels, $T_A = 25^\circ\text{C}$

IF BANDWIDTH—DOWNCONVERTER, LOWER SIDEBAND

LO frequency = 13 GHz.

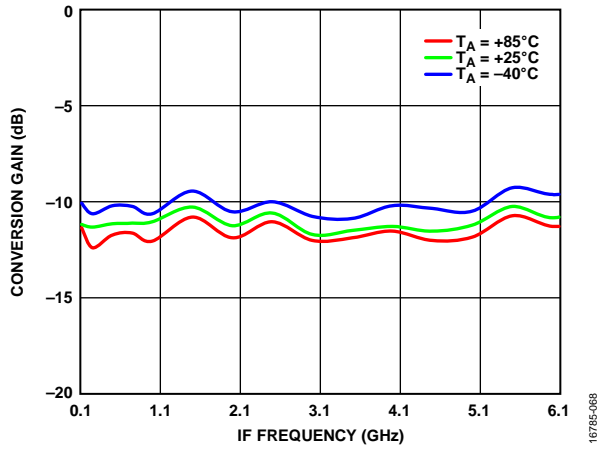

Figure 76. Conversion Gain vs. IF Frequency at Various Temperatures, LO = 4 dBm



Figure 78. Conversion Gain vs. IF Frequency at Various LO Power Levels, $T_A = 25^\circ\text{C}$

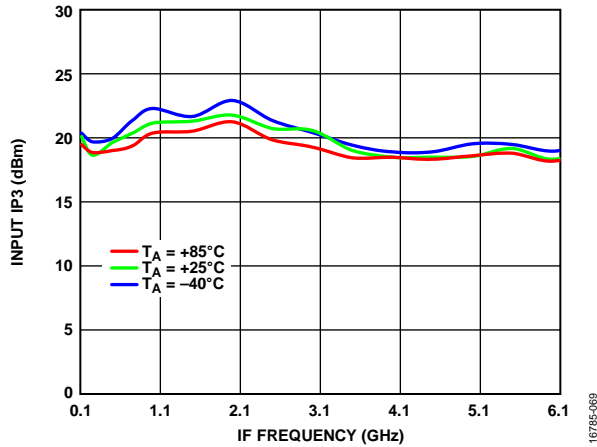

Figure 77. Input IP3 vs. IF Frequency at Various Temperatures, LO = 4 dBm



Figure 79. Input IP3 vs. IF Frequency at Various LO Power Levels, $T_A = 25^\circ\text{C}$

SPURIOUS AND HARMONICS PERFORMANCE

***M* × *N* Spurious Outputs**

Downconversion, Upper Sideband

Spur values are $(M \times RF) - (N \times LO)$. RF = 10.1 GHz, LO = 10 GHz, RF power = -10 dBm, and LO power = 13 dBm. Mixer spurious products are measured in dBc from the IF output power level. N/A means not applicable.

		N × LO				
		0	1	2	3	4
M × RF	0	0	25	3	N/A	N/A
	1	18	28	0	25	47
	2	N/A	N/A	63	75	71
	3	N/A	N/A	N/A	N/A	72
	4	N/A	N/A	N/A	N/A	N/A

Downconversion, Lower Sideband

Spur values are $(M \times RF) - (N \times LO)$. RF = 14 GHz, LO = 14.1 GHz, RF power = -10 dBm, and LO power = 13 dBm. Mixer spurious products are measured in dBc from the IF output power level. N/A means not applicable.

		N × LO				
		0	1	2	3	4
M × RF	0	0	18	0	N/A	N/A
	1	22	33	0	30	48
	2	N/A	N/A	58	75	62
	3	N/A	N/A	N/A	N/A	70
	4	N/A	N/A	N/A	N/A	N/A

Upconversion, Upper Sideband

Spur values are $(M \times IF_{IN}) + (N \times LO)$. IF_{IN} = 0.1 GHz, LO = 10 GHz, RF power = -10 dBm, and LO power = 13 dBm. Mixer spurious products are measured in dBc from the RF output power level. N/A means not applicable.

		N × LO				
		0	1	2	3	4
M × IF _{IN}	-5	75	77	74	70	N/A
	-4	80	79	73	70	N/A
	-3	83	77	63	71	N/A
	-2	85	78	44	74	N/A
	-1	49	39	3	53	N/A
	0	0	12	14	0	N/A
	+1	50	36	0	53	N/A
	+2	83	73	44	73	N/A
	+3	81	77	68	71	N/A
	+4	77	78	73	70	N/A
	+5	78	77	72	69	N/A

Upconversion, Lower Sideband

Spur values are $(M \times IF_{IN}) + (N \times LO)$. IF_{IN} = 0.1 GHz, LO = 14.1 GHz, RF power = -10 dBm, and LO power = 13 dBm. Mixer spurious products are measured in dBc from the RF output power level. N/A means not applicable.

		N × LO				
		0	1	2	3	4
M × IF _{IN}	-5	76	76	68	N/A	N/A
	-4	76	77	72	N/A	N/A
	-3	80	77	69	N/A	N/A
	-2	82	75	40	N/A	N/A
	-1	53	45	0	N/A	N/A
	0	0	24	8	N/A	N/A
	+1	53	41	0	N/A	N/A
	+2	82	73	44	N/A	N/A
	+3	79	74	63	N/A	N/A
	+4	79	73	65	N/A	N/A
	+5	75	73	68	N/A	N/A

THEORY OF OPERATION

The HMC798ALC4 is a subharmonically pumped ($\times 2$) MMIC mixer with an integrated LO amplifier that can be used as an upconverter or a downconverter from 24 GHz to 34 GHz. The LO amplifier is single bias at a 5 V dc with a typical 4 dBm LO drive level.

When used as a downconverter, the HMC798ALC4 downconverts radio frequencies between 24 GHz and 34 GHz to intermediate frequencies between dc and 4 GHz.

When used as an upconverter, the mixer up converts IF between dc and 4 GHz to RF between 24 GHz and 34 GHz.

APPLICATIONS INFORMATION

TYPICAL APPLICATION CIRCUIT

Figure 80 shows the typical application circuit for the HMC798ALC4. The integrated LO amplifier is single bias at 5 V with a typical 4 dBm input. Place capacitors as close as possible to the pin to decouple the power supply. The LO and RF pins are internally ac-coupled. The IF pin is internally dc-coupled. When IF operation to dc is not required, use of an external series capacitor is recommended, of a value chosen to pass the necessary IF frequency range. When IF operation to dc is required, do not exceed the IF source or sink current rating specified in the Absolute Maximum Ratings section.

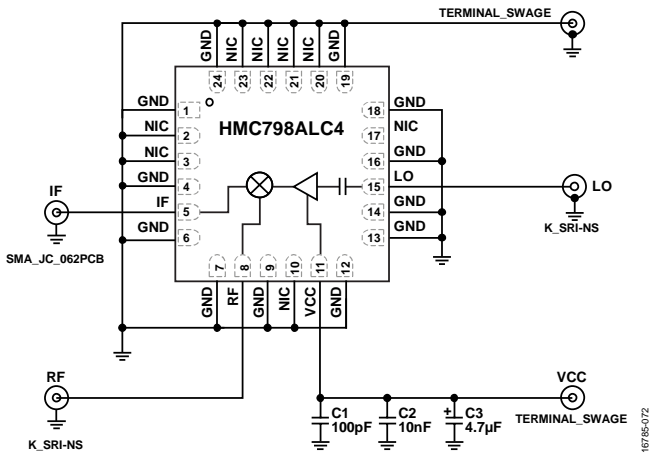

Figure 80. Typical Application Circuit

EVALUATION PCB INFORMATION

Use RF circuit design techniques for the circuit board used in the application. Ensure that signal lines have 50 Ω impedance, and connect the package ground leads and the exposed pad

directly to the ground plane (see Figure 81). Use a sufficient number of via holes to connect the top and bottom ground planes. The evaluation circuit board shown in Figure 81 is available from Analog Devices, Inc., upon request.

Table 5. List of Materials for Evaluation PCB
EV1HMC798ALC4

Item	Description
J1	Johnson Surface-Mount Type A (SMA) connector
J2, J3	SRI 2.92 mm connector
U1	HMC798ALC4
PCB ¹	126598-1 evaluation board
C1	C0G, 0402, 100 pF capacitor
C2	X7R, 0603, 10000 pF capacitor
C3	SMD, 3216, 4.7 µF capacitor

¹ 126598-1 is the raw bare PCB identifier. Reference EV1HMC798ALC4 when ordering the complete evaluation PCB.

SOLDERING INFORMATION AND RECOMMENDED LAND PATTERN

Figure 81 shows the recommended land pattern for the HMC798ALC4. The HMC798ALC4 is contained in a 3.90 mm × 3.90 mm, 24-terminal, ceramic LCC package with an exposed ground pad (EPAD). This exposed pad is internally connected to the ground of the chip. To minimize thermal impedance and ensure electrical performance, solder the exposed pad to the low impedance ground plane on the PCB. It is recommended that the ground planes on all layers under the exposed pad be stitched together with vias to further reduce thermal impedance. The land pattern on the HMC798ALC4 evaluation board provides a simulated thermal resistance (θ_{JC}) of 119°C/W.

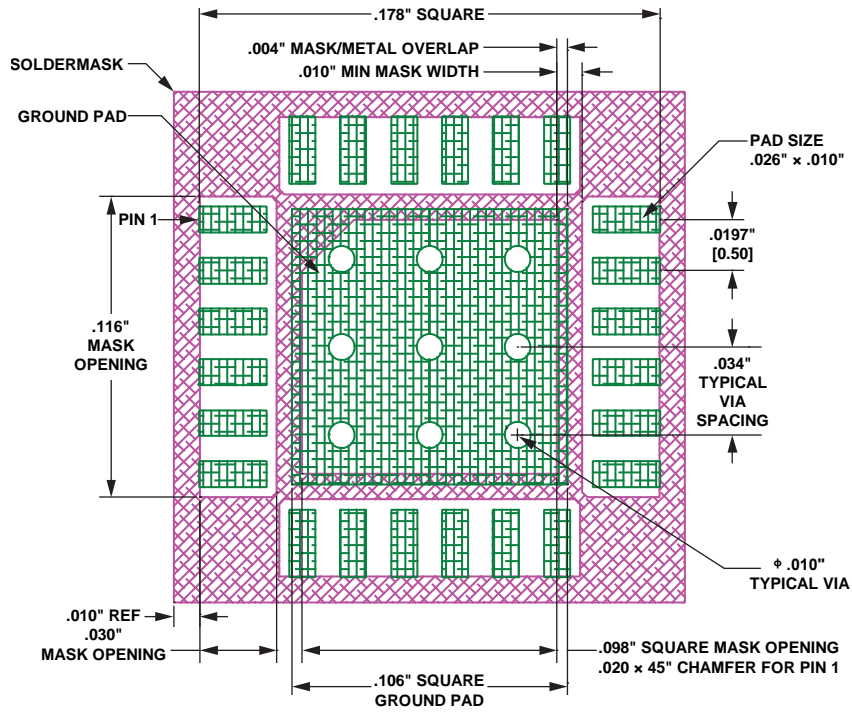

Figure 81. Evaluation Board Land Pattern for the HMC798ALC4 Package

16785-111

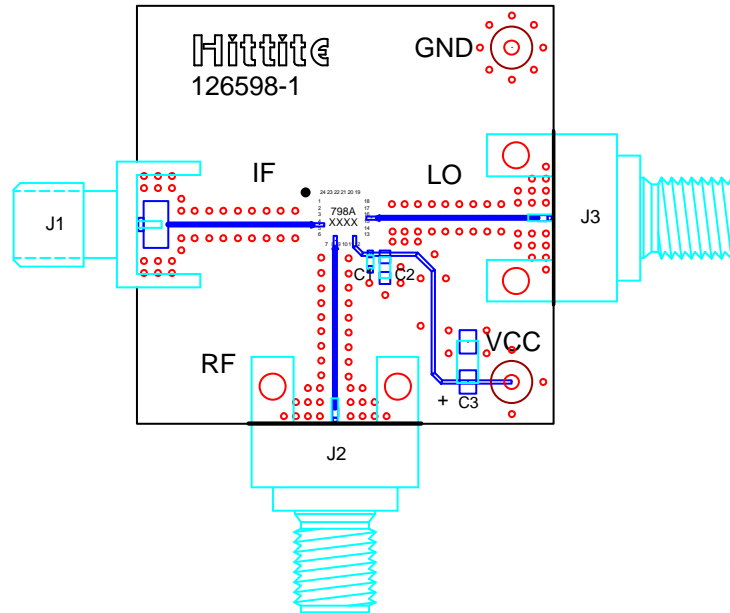

Figure 82. Evaluation PCB Top Layer

16785-073

OUTLINE DIMENSIONS



Figure 83. 24-Terminal Ceramic Leadless Chip Carrier [LCC] (E-24-1)
Dimensions shown in millimeters

ORDERING GUIDE

Model ¹	Temperature Range	MSL Rating ²	Package Description	Package Option
HMC798ALC4	-40°C to +85°C	MSL3	24-Terminal Ceramic Leadless Chip Carrier [LCC]	E-24-1
HMC798ALC4TR	-40°C to +85°C	MSL3	24-Terminal Ceramic Leadless Chip Carrier [LCC]	E-24-1
HMC798ALC4TR-R5	-40°C to +85°C	MSL3	24-Terminal Ceramic Leadless Chip Carrier [LCC]	E-24-1
EV1HMC798ALC4			Evaluation PCB Assembly	

¹ All models are RoHS compliant parts.

² The peak reflow temperature is 260°C. See the Absolute Maximum Ratings section, Table 2.