



WIDEBAND MMIC VCO WITH BUFFER AMPLIFIER 8.0 - 16.0 GHz

Typical Applications

Low Noise wideband MMIC VCO is ideal for:

- Industrial/Medical Equipment
- Test & Measurement Equipment
- Satcom
- Military Radar, EW, & ECM

Features

- Wide Tuning Bandwidth
- Put: +6 dBm
- Low SSB Phase Noise: -92 dBc/Hz @100 kHz
- No External Resonator Needed
- Single Positive Supply: +5V @ 75 mA
- Ceramic Leadless SMT Package: 16 mm²

Functional Diagram

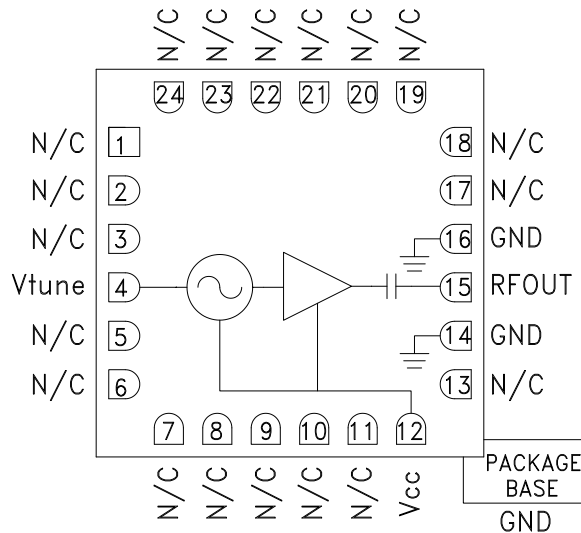

General Description

The HMC6380LC4B is a wideband MMIC Voltage Controlled Oscillator which incorporates the resonator, negative resistance device, and varactor diode. Output power and phase noise performance are excellent over temperature due to the oscillator's monolithic construction. The Vtune port accepts an analog tuning voltage from 0 to +23V. The HMC6380LC4B VCO operates from a single +5V supply, consumes only 75 mA of current, and is housed in a RoHS compliant SMT package. This wideband VCO uniquely combines the attributes of ultra small size, low phase noise, low power consumption, and wide tuning range.

Electrical Specifications, $T_A = +40\text{ }^\circ\text{C to } +85\text{ }^\circ\text{C}$, $V_{cc} = +5V$ [1]

Parameter	Min.	Typ.	Max.	Units
Frequency Range	8.0 - 16.0			GHz
Power Output	2	6	9	dBm
SSB Phase Noise @ 10 kHz Offset		-64	-50	dBc/Hz
SSB Phase Noise @ 100 kHz Offset		-92	-85	dBc/Hz
SSB Phase Noise @ 1 MHz Offset		-120	-110	dBc/Hz
Supply Current (I _{cc}) (V _{cc} = +5V)		75	85	mA
Tune Voltage (V _{tune})	0		23	V
Tune Port Leakage Current (V _{tune} = +23V)			100	μA
Tuning Sensitivity	200	450	600	MHz/V
Output Return Loss		10		dB
2nd Harmonic		-11		dBc
3rd Harmonic		-25		dBc
Pulling (into a 2.0:1 VSWR)		28		MHz/pp
V _{cc} Pushing, Frequency = 16 GHz		55		MHz/V
Frequency Drift Rate		0.5		MHz/°C

[1] A broadband load VSWR of $\leq 2.0:1$, across the frequency range of 0.01-16 GHz, is required for proper operation.



WIDEBAND MMIC VCO WITH BUFFER AMPLIFIER
8.0 - 16.0 GHz

Frequency vs. Tuning Voltage, $V_{cc} = +5V$

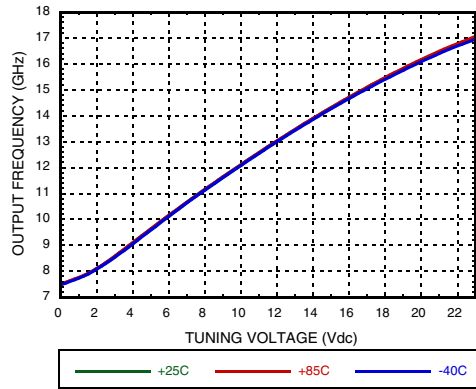

Output Power vs. Tuning Voltage

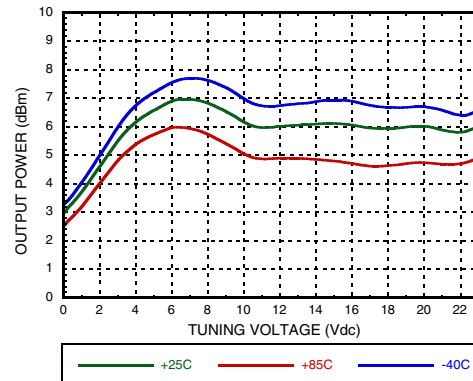

Sensitivity vs. Tuning Voltage

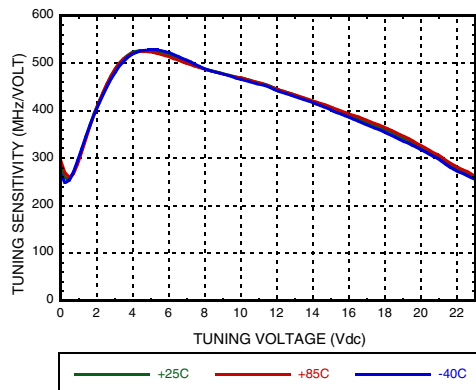

Supply Current

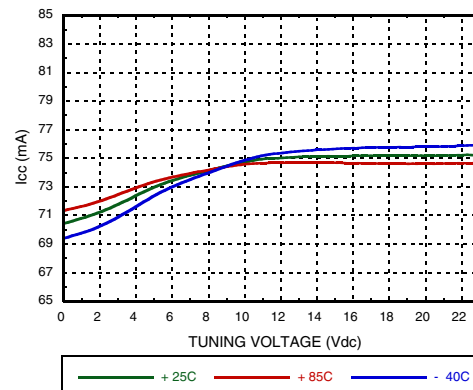

SSB Phase Noise vs. Tuning Voltage

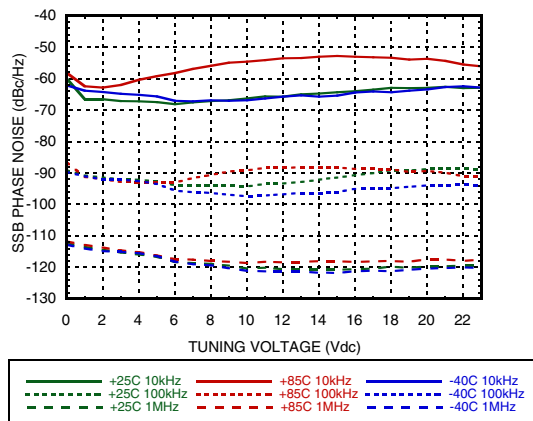

Typical SSB Phase Noise @ $V_{tune} = +10V$

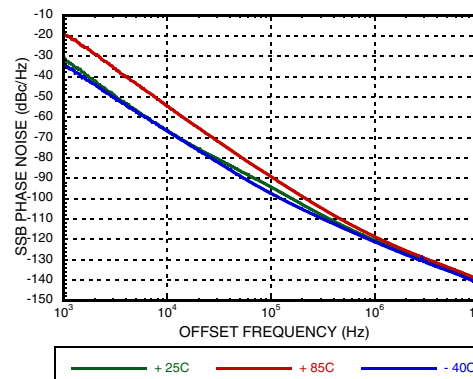



WIDEBAND MMIC VCO WITH BUFFER AMPLIFIER 8.0 - 16.0 GHz

Typical Supply Current vs. Vcc, +25C

Vcc (V)	Icc (mA)
4.75	69
5.0	75
5.25	79

Absolute Maximum Ratings

Vcc	+5.5 V
Vtune	-0.5V to +25V
Storage Temperature	-65 °C to +150 °C
ESD Sensitivity (HBM)	Class 1A
ESD Sensitivity (FICDM)	Class C3

Reliability Information

Junction Temperature To Maintain 1 Million Hour MTTF	135 °C
Nominal Junction Temperature (T = 85 °C)	121.3 °C
Thermal Resistance (Junction to exposed paddle, 5V supply)	97 °C/W
Operating Temperature	-40 °C to + 85 °C

Outline Drawing

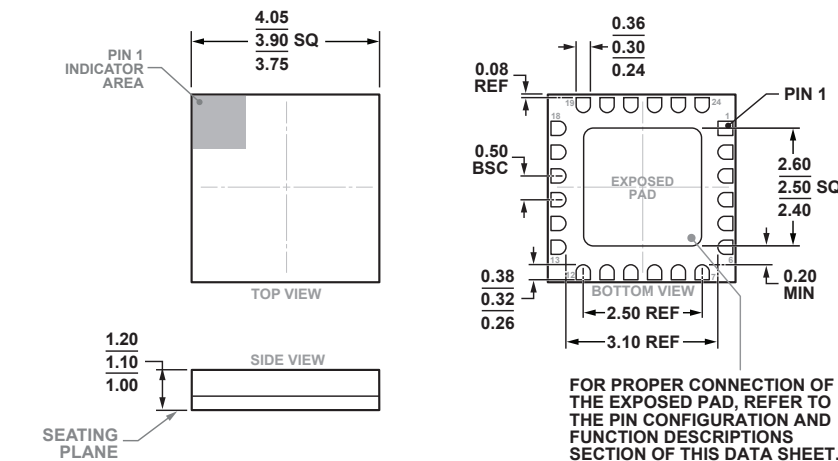

24-Terminal Ceramic Leadless Chip Carrier [LCC]
(E-24-2)

Dimensions shown in millimeters.

NOTES:

- PACKAGE BODY MATERIAL: ALUMINA
- LEAD AND GROUND PADDLE PLATING: 30-80 MICROINCHES GOLD OVER 50 MICROINCHES MINIMUM, NICKEL.
- DIMENSIONS ARE IN INCHES [MILLIMETERS]
- LEAD SPACING TOLERANCE IS NON-CUMULATIVE.
- PACKAGE WARP SHALL NOT EXCEED 0.05mm.
- ALL GROUND LEADS AND GROUND PADDLE MUST BE SOLDERED TO PCB RF GROUND.

Package Information

Part Number	Package Body Material	Lead Finish	MSL Rating	Package Marking ^[2]
HMC6380LC4B	RoHS-compliant Ceramic SMT Package	Gold Flash Over Nickel	MSL3 ^[1]	H6380 XXXX



[1] Max peak reflow temperature of 260 °C

[2] 4-Digit lot number XXXX

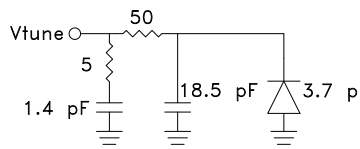
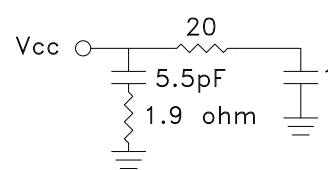
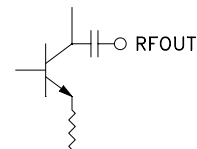

WIDEBAND MMIC VCO WITH BUFFER AMPLIFIER 8.0 - 16.0 GHz

Pin Descriptions

Pin Number	Function	Description	Interface Schematic
1 - 3, 5 - 11, 13, 17 - 24	N/C	No internal connection. These pins may be connected to RF/DC ground. Performance will not be affected.	
4	Vtune	Control voltage and modulation Input. Modulation bandwidth dependent on drive source impedance. .	
12	Vcc	Supply voltage, Vcc= +5V	
15	RFOUT	RF output (AC coupled)	
14, 16 Paddle	GND	Package bottom has an exposed metal paddle that must be connected to RF & DC ground.	

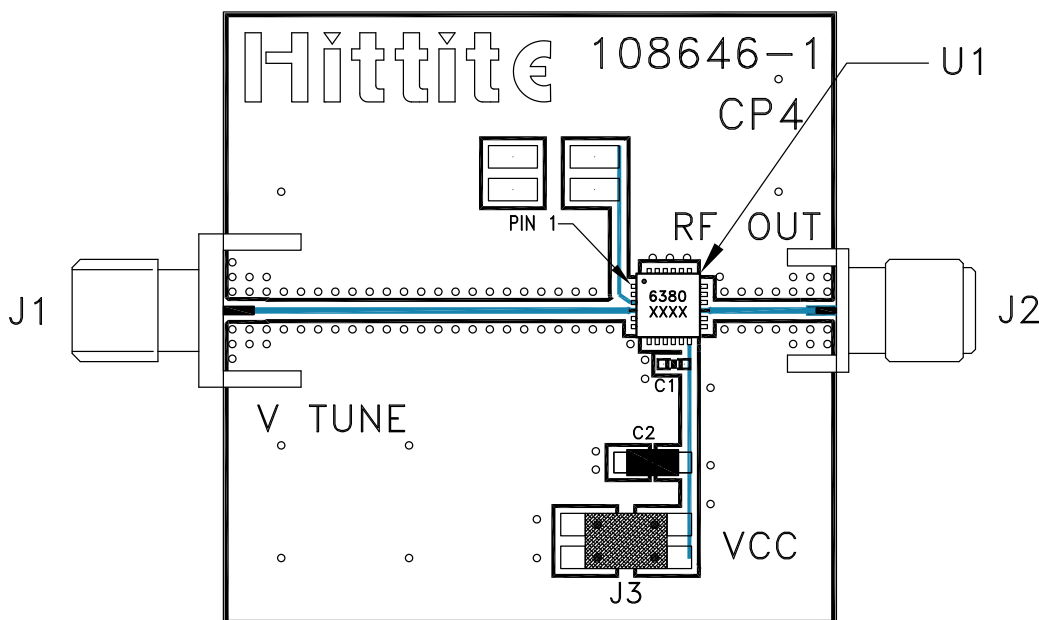
**WIDEBAND MMIC VCO WITH BUFFER AMPLIFIER
8.0 - 16.0 GHz**
Evaluation PCB

List of Materials for Evaluation PCB 108648-HMC6380LC4B [1]

Item	Description
J1	RF Connector, SMA
J2	RF Connector, SMA
J3	DC Header
C1	1000 pF Capacitor, 0402 Pkg.
C2	4.7 μ F Capacitor, Tantalum
U1	HMC6380LC4B
PCB [2]	108646 Eval Board

[1] Reference this number when ordering complete evaluation PCB

[2] Circuit Board Material: Arlon 25FR or Rogers 4350

The circuit board used in the application should use RF circuit design techniques. Signal lines should have 50 Ohm impedance while the package ground leads and exposed ground paddle should be connected directly to the ground plane similar to that shown. A sufficient number of via holes should be used to connect the top and bottom ground planes. The evaluation circuit board shown is available from Analog Devices upon request.



HMC6380LC4B

v03.1118



WIDEBAND MMIC VCO WITH BUFFER AMPLIFIER 8.0 - 16.0 GHz

Notes:

WIDEBAND VCOS - SMT