



# 11.41 GHz to 12.62 GHz MMIC VCO with Half Frequency Output

Data Sheet

HMC1166

## FEATURES

Dual output frequency range

$$f_{OUT} = 11.41 \text{ GHz to } 12.62 \text{ GHz}$$

$$f_{OUT/2} = 5.705 \text{ GHz to } 6.31 \text{ GHz}$$

Output power ( $P_{OUT}$ ): 11 dBm

Single-sideband (SSB) phase noise:  $-115 \text{ dBc/Hz}$  at 100 kHz

No external resonator needed

RoHS compliant, 5 mm  $\times$  5 mm, 32-lead LFCSP: 25 mm<sup>2</sup>

## APPLICATIONS

Point to point and multipoint radios

Test equipment and industrial controls

Very small aperture terminals (VSATs)

## GENERAL DESCRIPTION

The HMC1166 is a monolithic microwave integrated circuit (MMIC), voltage controlled oscillator (VCO) that integrates a resonator, a negative resistance device, and a varactor diode, and features a half frequency output.

## FUNCTIONAL BLOCK DIAGRAM

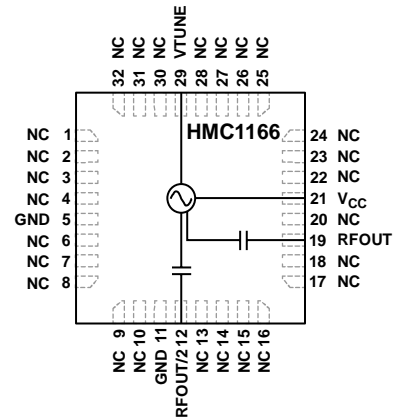

Figure 1.

Because of the monolithic construction of the oscillator, the output power and phase noise performance are excellent over temperature.

The output power is 11 dBm typical from a 5 V supply voltage. The VCO is housed in a RoHS compliant LFCSP and requires no external matching components.

Rev. 0

[Document Feedback](#)

Information furnished by Analog Devices is believed to be accurate and reliable. However, no responsibility is assumed by Analog Devices for its use, nor for any infringements of patents or other rights of third parties that may result from its use. Specifications subject to change without notice. No license is granted by implication or otherwise under any patent or patent rights of Analog Devices. Trademarks and registered trademarks are the property of their respective owners.

One Technology Way, P.O. Box 9106, Norwood, MA 02062-9106, U.S.A.  
Tel: 781.329.4700 ©2016 Analog Devices, Inc. All rights reserved.  
[Technical Support](#) [www.analog.com](http://www.analog.com)

**TABLE OF CONTENTS**

Features .....	1	Typical Performance Characteristics .....	7
Applications.....	1	Theory of Operation .....	9
Functional Block Diagram .....	1	Applications Information .....	10
General Description .....	1	Evaluation Printed Circuit Board (PCB).....	11
Revision History .....	2	Bill of Materials.....	11
Specifications.....	3	Packaging and Ordering Information .....	12
Absolute Maximum Ratings .....	4	Outline Dimensions.....	12
ESD Caution.....	4	Ordering Guide .....	12
Pin Configuration and Function Descriptions.....	5		
Interface Schematics.....	6		

**REVISION HISTORY**

**1/16—Revision 0: Initial Version**

## SPECIFICATIONS

$T_A = -40^{\circ}\text{C}$  to  $+85^{\circ}\text{C}$ ,  $V_{CC} = 5\text{ V}$ , unless otherwise noted.

Table 1.

Parameter	Min	Typ	Max	Unit	Test Conditions/Comments
<b>FREQUENCY</b>					
Range					
Output Frequency ( $f_{OUT}$ )	11.41		12.62	GHz	
Half Output Frequency ( $f_{OUT}/2$ )	5.705		6.31	GHz	
Drift Rate		1.0		MHz/ $^{\circ}\text{C}$	
Pulling		2		MHz p-p	Pulling into a 2.0:1 voltage standing wave ratio (VSWR) At VTUNE = 5 V
Pushing		5		MHz/V	
<b>OUTPUT POWER (<math>P_{OUT}</math>)</b>					
RFOUT	7	11	15	dBm	
RFOUT/2	0	4	9	dBm	
Supply Current ( $I_{CC}$ )		200		mA	$V_{CC} = 4.75\text{ V}$
		220	270	mA	$V_{CC} = 5.00\text{ V}$
		240		mA	$V_{CC} = 5.25\text{ V}$
<b>HARMONICS, SUBHARMONICS</b>					
1/2		40		dBc	
3/2		30		dBc	
Second		20		dBc	
Third		26		dBc	
<b>TUNING</b>					
Voltage (VTUNE)	2		13	V	
Sensitivity	75		325	MHz/V	
Tune Port Leakage Current			10	$\mu\text{A}$	VTUNE = 13 V
<b>OUTPUT RETURN LOSS</b>					
		5		dB	
<b>SSB PHASE NOISE</b>					
10 kHz Offset		-89	-85	dBc/Hz	
100 kHz Offset		-115	-112	dBc/Hz	

**ABSOLUTE MAXIMUM RATINGS**

Table 2.

Parameter	Rating
V <sub>CC</sub>	5.5 V dc
VTUNE	0 V to 15 V
Operating Temperature Range	−40°C to +85°C
Storage Temperature Range	−65°C to +150°C
Nominal Junction Temperature (to Maintain 1 Million Hour Mean Time to Failure (MTTF))	135°C
Nominal Junction Temperature (T <sub>A</sub> = 85°C)	119°C
Maximum Reflow Temperature (MSL3 Rating)	260°C
Thermal Resistance (Junction to Ground Pad)	29°C/W
ESD Sensitivity	
Human Body Model (HBM)	300 V (Class 1A)
Field Induced Charged Device Model (FICDM)	300 V (Class II)

Stresses at or above those listed under Absolute Maximum Ratings may cause permanent damage to the product. This is a stress rating only; functional operation of the product at these or any other conditions above those indicated in the operational section of this specification is not implied. Operation beyond the maximum operating conditions for extended periods may affect product reliability.

**ESD CAUTION****ESD (electrostatic discharge) sensitive device.**

Charged devices and circuit boards can discharge without detection. Although this product features patented or proprietary protection circuitry, damage may occur on devices subjected to high energy ESD. Therefore, proper ESD precautions should be taken to avoid performance degradation or loss of functionality.

## PIN CONFIGURATION AND FUNCTION DESCRIPTIONS

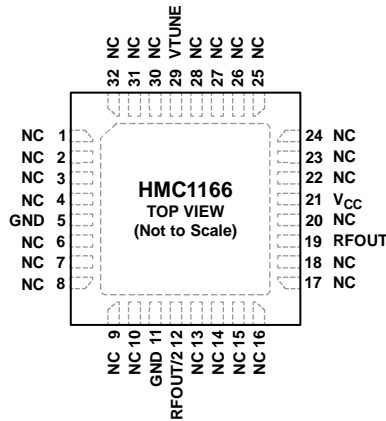

- NOTES**
1. NC = NO CONNECT. HOWEVER, THESE PINS CAN BE CONNECTED TO RF/DC GROUND WITHOUT AFFECTING THE PERFORMANCE OF THE DEVICE.
  2. EXPOSED PAD. THE PACKAGE BOTTOM HAS AN EXPOSED METAL PAD THAT MUST BE CONNECTED TO RF/DC GROUND.

13946-002

Figure 2. Pin Configuration

Table 3. Pin Function Descriptions

Pin No.	Mnemonic	Description
1 to 4, 6 to 10, 13 to 18, 20, 22 to 28, 30 to 32	NC	No Connect. However, these pins can be connected to RF/dc ground without affecting the performance of the device.
5, 11	GND	Ground. These pins must be connected to RF/dc ground.
12	RFOUT/2	Half Radio Frequency Output. This pin is ac-coupled.
19	RFOUT	Radio Frequency Output. This pin is ac-coupled.
21	V <sub>CC</sub>	Supply Voltage (5 V).
29	VTUNE	Control Voltage and Modulation Input. The modulation bandwidth is dependent on the drive source impedance.
	EP	Exposed Pad. The package bottom has an exposed metal pad that must be connected to RF/dc ground.

INTERFACE SCHEMATICS

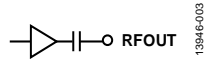

Figure 3. RFOUT Interface

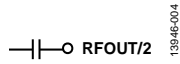

Figure 4. RFOUT/2 Interface

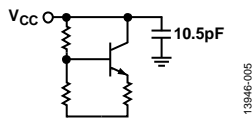

Figure 5. Vcc Interface

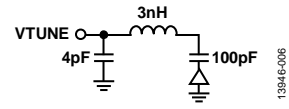

Figure 6. VTUNE Interface



Figure 7. GND Interface

### TYPICAL PERFORMANCE CHARACTERISTICS

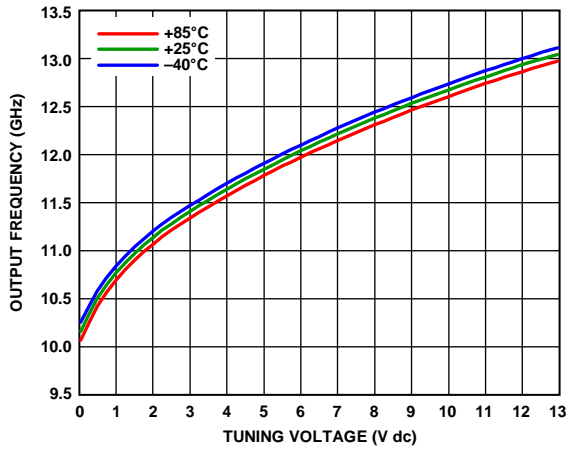

Figure 8. Output Frequency vs. Tuning Voltage

13946-008

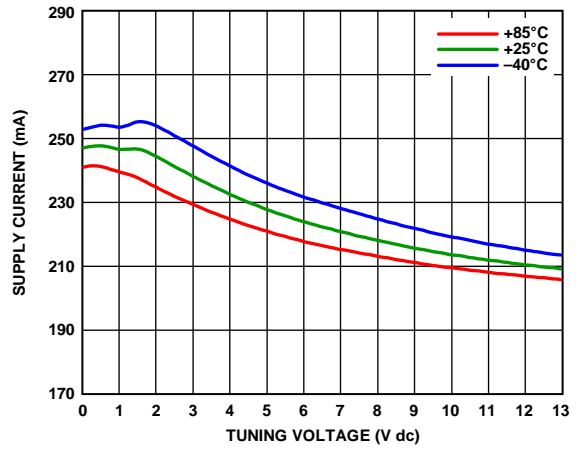

Figure 11. Supply Current ( $I_{CC}$ ) vs. Tuning Voltage

13946-011

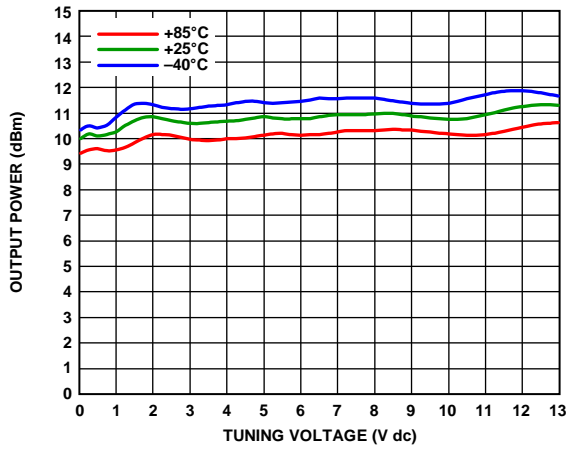

Figure 9. Output Power vs. Tuning Voltage

13946-009

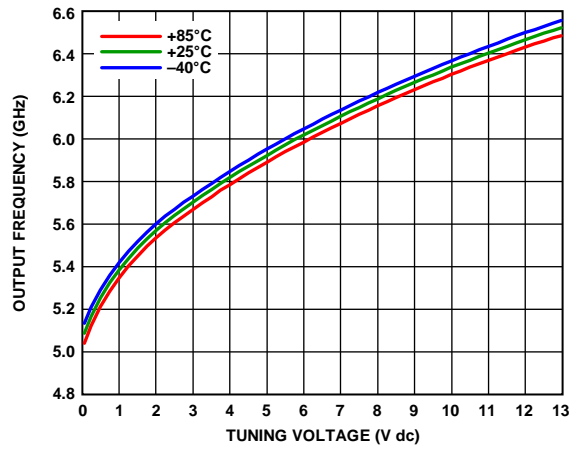

Figure 12. RFOUT/2 Output Frequency vs. Tuning Voltage

13946-012

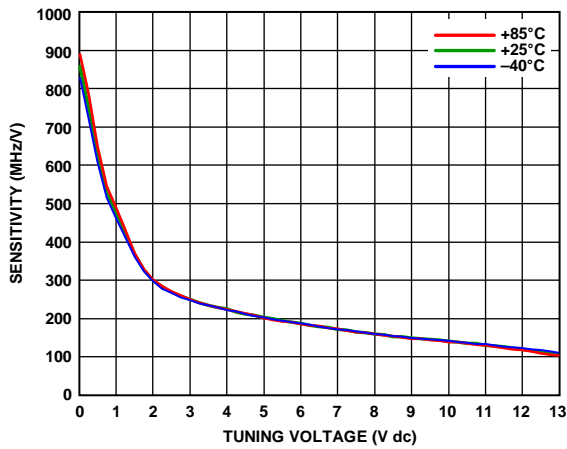

Figure 10. Sensitivity vs. Tuning Voltage

13946-010

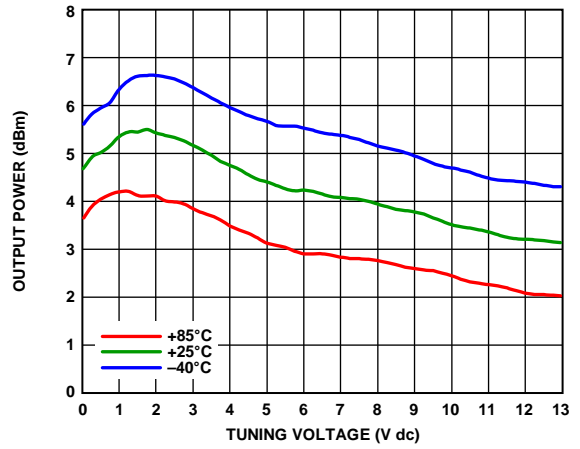

Figure 13. RFOUT/2 Output Power vs. Tuning Voltage

13946-013

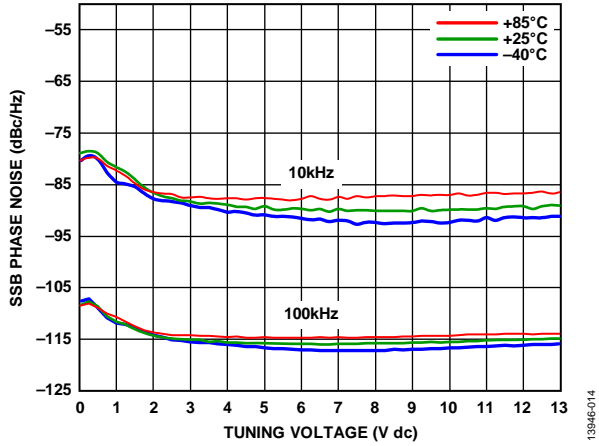

Figure 14. SSB Phase Noise vs. Tuning Voltage

13846-014

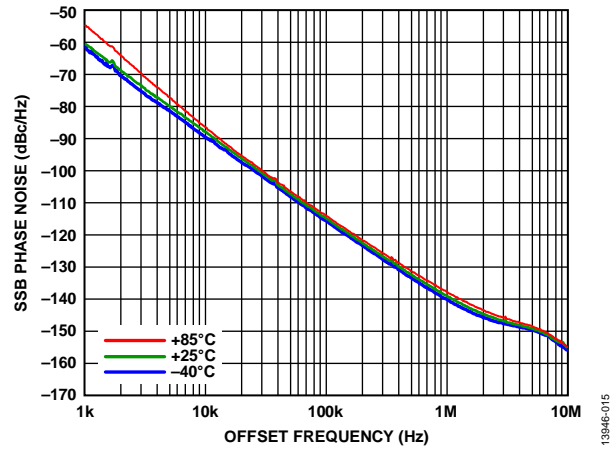

Figure 15. SSB Phase Noise vs. Offset Frequency at VTUNE = 5 V

13846-015



## THEORY OF OPERATION

The HMC1166 voltage controlled oscillator is a free running voltage controlled frequency source. The output frequency is controlled by applying a variable tune voltage to the VTUNE port. Because VTUNE is varied from the lowest to the highest allowed voltage, the VCO output frequency increases from the lowest to the highest operating frequency. This VCO output frequency change with the applied VTUNE input results in the VCO frequency sensitivity characteristic (MHz/V). The VCO frequency sensitivity is not constant and varies across the tunable range.

The HMC1166 VCO is specified to cover the minimum to maximum frequencies specified in this data sheet over the entire specified temperature range, including the VCO frequency drift (MHz/°C). In addition, for low phase noise operation, drive the VTUNE port from a low noise voltage source. Excessive noise on the VTUNE port results in poor phase noise performance. The tune port modulation bandwidth is typically greater than 10 MHz.

To achieve optimum VCO phase noise performance when using the HMC1166, it is important to use a low noise power supply for V<sub>CC</sub> biasing. Because the VCO output frequency changes with small changes in the V<sub>CC</sub> bias voltage (pushing), noise on the V<sub>CC</sub> bias pin results in increased phase noise. Take care to use low noise regulators, otherwise, bias line noise may corrupt the low phase noise output of the HMC1166.

Internally, the radio frequency (RF) output frequency is generated from a doubler circuit. This generation results in an unwanted low level output signal present at half the RFOUT frequency (RFOUT/2). If necessary, this undesired spurious signal can be further filtered on the customer application board using a band pass filter. The RFOUT/2 output signal is available directly at the RFOUT/2 port. The RFOUT/2 port commonly drives a phase-locked loop (PLL)/synthesizer for phase locking the HMC1166 output if needed.

Lastly, the HMC1166 RFOUT port incorporates an internal buffer amplifier to provide good output matching. The internal buffer amplifier also isolates the VCO core from the output load and minimizes the VCO frequency change with the changes to the output load impedance (pulling).

## APPLICATIONS INFORMATION

The HMC1166 serves as the local oscillator (LO) in microwave synthesizer applications. The primary applications are point to point microwave radios, military, radars, test and measurement, as well as industrial and medical equipment. The low phase noise allows higher orders of modulation and offers improved bit error rates in communication systems, whereas the linear,

monotonic tuning sensitivity allows a stable loop filter design. The higher output power minimizes the gain required to drive subsequent stages. The half frequency output reduces the input frequency to the prescaler without the addition of residual phase noise to the input of the phase-locked loop synthesizer.

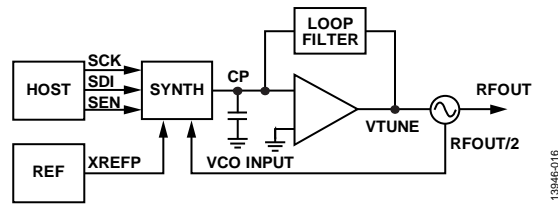

Figure 16. Typical Application Diagram

## EVALUATION PRINTED CIRCUIT BOARD (PCB)

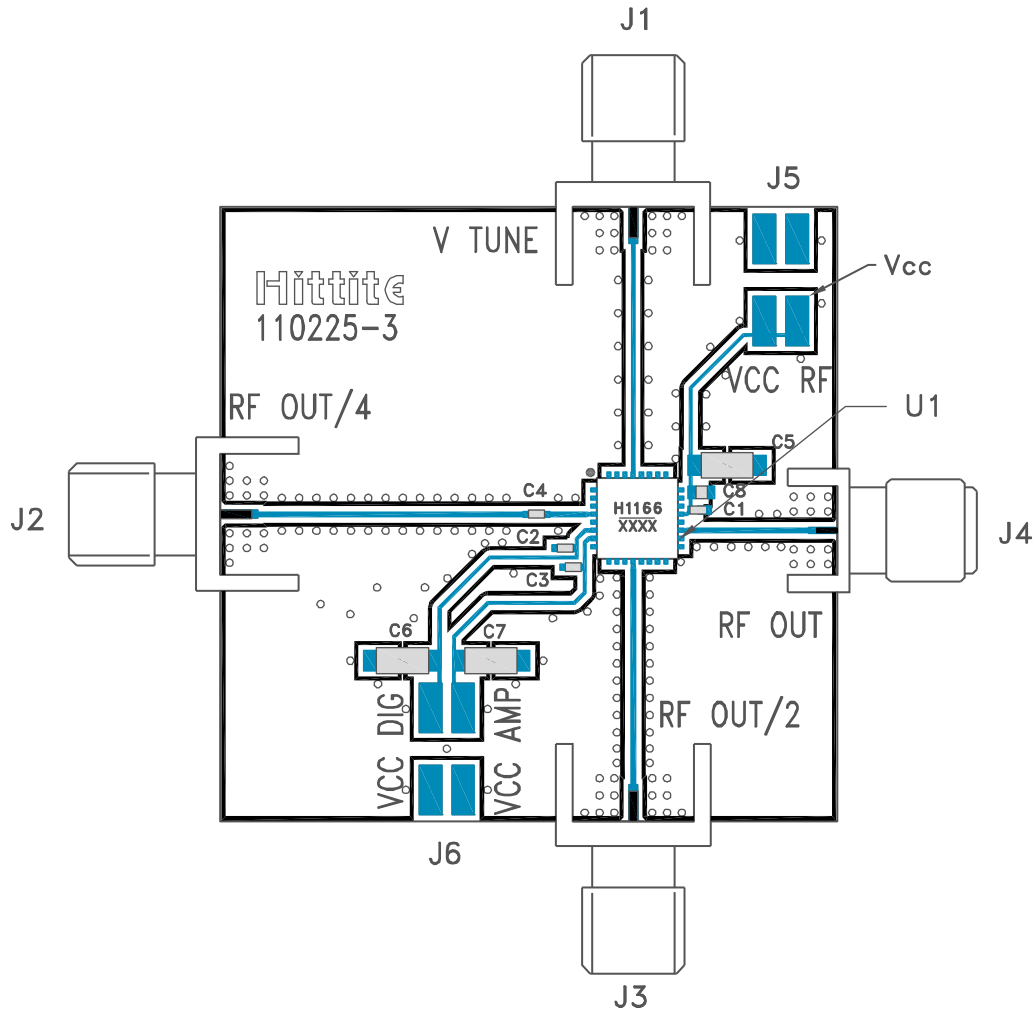

Figure 17. Evaluation PCB

13946-017

The circuit board used in an application uses RF circuit design techniques. Ensure that the signal lines have  $50\ \Omega$  impedance and that the package ground leads and backside ground paddle are connected directly to the ground plane.

Use a sufficient number of via holes to connect the top and bottom ground planes. The evaluation circuit board shown in Figure 17 is available from Analog Devices, Inc., upon request.

## BILL OF MATERIALS

Table 4. Bill of Materials for the [EV1HMC1166LP5](#)

Item	Description
J1 to J4	PCB mount SMA RF connectors
J5, J6	2 mm dc headers
C1 to C3	100 pF capacitors, 0402 package
C4	1000 pF capacitor, 0402 package
C5 to C7	2.2 $\mu$ F tantalum capacitors
C8	0.01 $\mu$ F capacitor, 0603 package
U1	<a href="#">HMC1166</a> VCO
PCB <sup>1</sup>	110225 evaluation board <sup>2</sup>

<sup>1</sup> Circuit board material is Rogers 4350.

<sup>2</sup> Reference this number when ordering the complete evaluation PCB.

PACKAGING AND ORDERING INFORMATION

OUTLINE DIMENSIONS

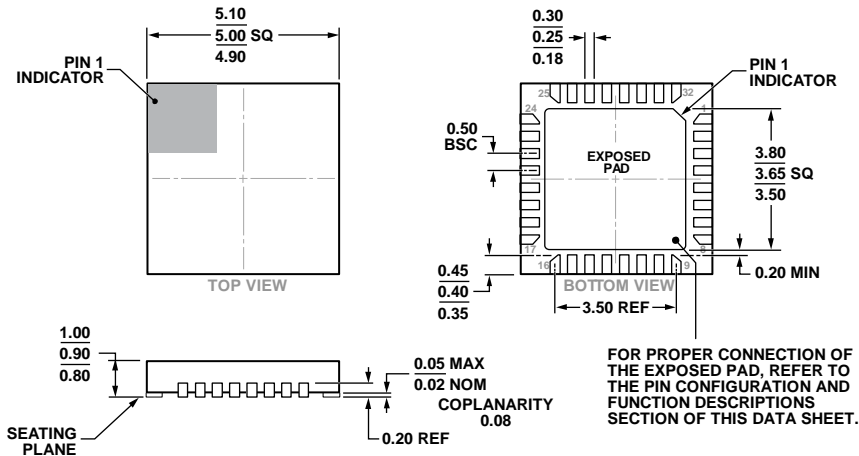

COMPLIANT TO JEDEC STANDARDS MO-220-VHHD-4.

Figure 18. 32-Lead Lead Frame Chip Scale Package [LFCSP]  
 5 mm × 5 mm Body and 0.90 mm Package Height  
 (HCP-32-1)  
 Dimensions shown in millimeters

ORDERING GUIDE

Model <sup>1</sup>	Temperature Range	MSL Rating <sup>2</sup>	Package Description	Package Option	Qty.	Branding <sup>3</sup>
HMC1166LP5E	-40°C to +85°C	MSL3	32-Lead LFCSP	HCP-32-1		H1166 XXXX
HMC1166LP5ETR	-40°C to +85°C	MSL3	32-Lead LFCSP, 7" Tape and Reel	HCP-32-1	500	H1166 XXXX
EV1HMC1166LP5			Evaluation Board			

<sup>1</sup> The HMC1166LP5E and HMC1166LP5ETR are RoHS compliant parts.

<sup>2</sup> See the Absolute Maximum Ratings section, Table 2.

<sup>3</sup> XXXX is a placeholder for the 4-digit lot number.