

HCPL-3100, HCPL-3101

Power MOSFET/IGBT Gate Drive Optocouplers



Data Sheet



Description

The HCPL-3100/3101 consists of an LED* optically coupled to an integrated circuit with a power output stage. These optocouplers are suited for driving power MOSFETs and IGBTs used in motor control inverter applications. The high operating voltage range of the output stage provides the voltage drives required by gate controlled devices. The voltage and current supplied by these optocouplers allow for direct interfacing to the power device without the need for an intermediate amplifier stage.

The HCPL-3100 switches a 3000 pF load in 2 μ s and the HCPL-3101, using a higher speed LED, switches a 3000 pF load in 0.5 μ s. With a CMR rating of 15 kV/ μ s typical these opto-couplers readily reject transients found in inverter applications.

The LED controls the state of the output stage. Transistor Q2 in the output stage is on with the LED off, allowing the gate of the power device to be held low. Turning on the LED turns off transistor Q2 and switches on transistor Q1 in the output stage which provides current and voltage to drive the gate of the power device.

Features

- High output current I_{O1} and I_{O2} (0.6 A Peak, 0.1 A Continuous)
- 15 kV/ μ s minimum Common Mode Rejection (CMR) at $V_{CM} = 1500$ V
- Wide operating V_{CC} range (15 to 30 volts)
- High speed
 - 1 μ s typical propagation delay (HCPL-3100)
 - 0.3 μ s typical propagation delay (HCPL-3101)
- Recognized under UL 1577 for dielectric withstand proof test voltages of 5000 vac, 1 minute

Applications

- Isolated MOSFET/IGBT gate drive
- AC and DC motor drives
- General purpose industrial inverters
- Uninterruptable power supply

Functional Diagram

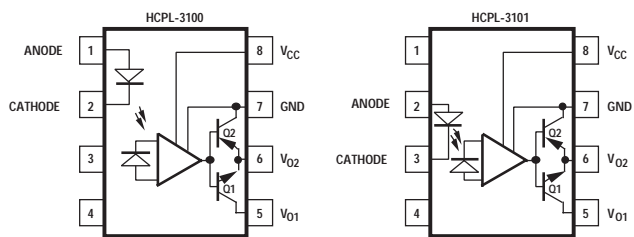

TRUTH TABLE

LED	OUTPUT	Q1	Q2
ON	HIGH LEVEL	ON	OFF
OFF	LOW LEVEL	OFF	ON

THE USE OF A 0.1 μ F BYPASS CAPACITOR CONNECTED BETWEEN PINS 8 AND 7 IS RECOMMENDED. ALSO CURRENT LIMITING RESISTOR IS RECOMMENDED (SEE FIGURE 1, AND NOTE 2 AND NOTE 7).

*HCPL-3100 LED contains Silicon-doped GaAs and HCPL-3101 LED contains AlGaAs.

CAUTION: It is advised that normal static precautions be taken in handling and assembly of this component to prevent damage and/or degradation which may be induced by ESD.

Schematic

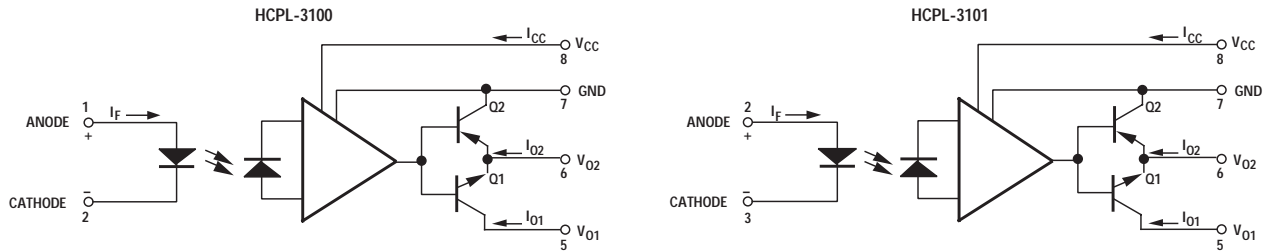

THE USE OF A 0.1 μ F BYPASS CAPACITOR CONNECTED BETWEEN PINS 8 AND 7 IS RECOMMENDED. ALSO CURRENT LIMITING RESISTOR IS RECOMMENDED (SEE FIGURE 1, AND NOTE 2 AND NOTE 7).

Ordering Information

HCPL-3100 and HCPL-3101 are UL Recognized with 5000 Vrms for 1 minute per UL1577.

Part Number	Option	Package	Surface Mount	Gull Wing	Tape & Reel	Quantity
	RoHS Compliant					
HCPL-3100	-000E	300 mil DIP-8				50 per tube
HCPL-3101	-300E		X	X		50 per tube
	-500E		X	X	X	1000 per reel

To order, choose a part number from the part number column and combine with the desired option from the option column to form an order entry.

Example 1:

HCPL-3100-500E to order product of 300 mil DIP Gull Wing Surface Mount package in Tape and Reel packaging and RoHS compliant.

Example 2:

HCPL-3101-000E to order product of 300 mil DIP package in Tube packaging and RoHS compliant.

Option datasheets are available. Contact your Avago sales representative or authorized distributor for information.

Remarks: The notation '#XXX' is used for existing products, while (new) products launched since July 15, 2001 and RoHS compliant will use '-XXXE.'

Outline Drawing

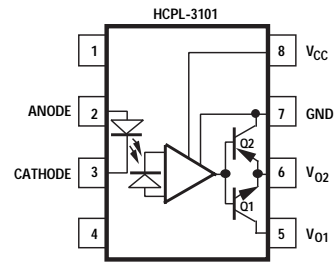
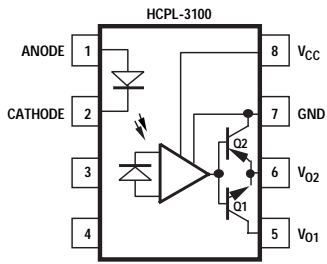
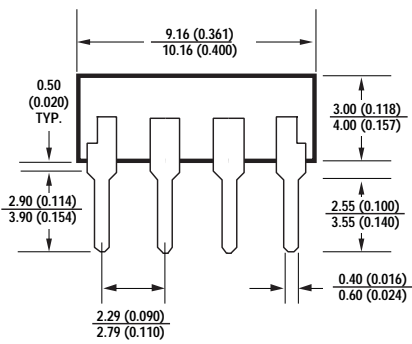
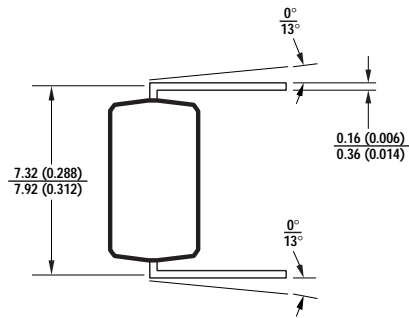
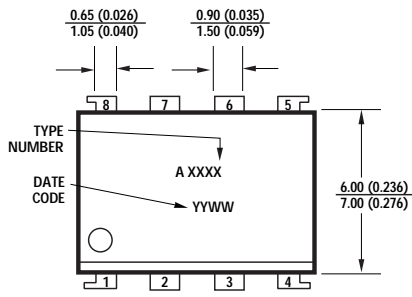

Demonstrated ESD Performance

Human Body Model: MIL-STD-883 Method 3015.7: Class 2
Machine Model: EIAJ IC-121-1988 (1988.3.28 Version 2), Test Method 20, Condition C: 1200 V

Regulatory Information

The HCPL-3100/3101 has been approved by the following organization:

UL

Recognized under UL 1577, Component Recognition Program, File E55361.

Insulation and Safety Related Specifications

Parameter	Symbol	Value	Units	Conditions
Min. External Air Gap (External Clearance)	L(I01)	6.0	mm	Shortest distance measured through air, between two conductive leads, input to output
Min. External Tracking Path (External Creepage)	L(I02)	6.0	mm	Shortest distance path measured along outside surface of optocoupler body between input and output leads
Min. Internal Plastic Gap (Internal Clearance)		0.15	mm	Through insulation distance conductor to conductor inside the optocoupler cavity

Absolute Maximum Ratings

Parameter	Symbol	Device	Min.	Max.	Unit	Conditions	Fig.	Note
Storage Temperature	T_S		-55	125	°C			
Operating Temperature	T_A	HCPL-3100	-40	100	°C			
		HCPL-3101	-40	85				
Input	Continuous Current	HCPL-3100		25	mA	$T_A = 25^\circ\text{C}$	11	1
		HCPL-3101		20	mA			
	Reverse Voltage	HCPL-3100		6	V			
		HCPL-3101		5				
Supply Voltage V_{CC}			35	V				
Output 1	Continuous Current	I_{O1}		0.1	A			1
	Peak Current			0.6	A	Pulse Width < 0.15 μs , Duty cycle = 1%		1
	Voltage		V_{O1}		35	V		
Output 2	Continuous Current	I_{O2}		0.1	A			1
	Peak Current			0.6	A	Pulse Width < 0.15 μs , Duty cycle = 1%		1
Output Power Dissipation	P_O			500	mW		12	1
Total Power Dissipation	P_T			550	mW		12	1
Lead Solder Temperature		270°C for 10 s, 1.0 mm below seating plane						

Recommended Operating Conditions

Parameter	Symbol	Device	Min.	Max.	Units
Power Supply Voltage	V_{CC}		15	30	V
Input Current (ON)	I_F	HCPL-3100	14	20	mA
		HCPL-3101	15	20	mA
Operating Temperature	T_A		-40	70	°C

Recommended Protection for Output Transistors

During switching transitions, the output transistors Q1 and Q2 of the HCPL-3100/3101 can conduct large amounts of current. Figure 1 describes a

recommended circuit design showing a current limiting resistor R_2 which is necessary in order to prevent damage to the output transistors Q1 and Q2. (See Note 7.) A bypass capacitor C_1 is also recommended to reduce power supply noise.

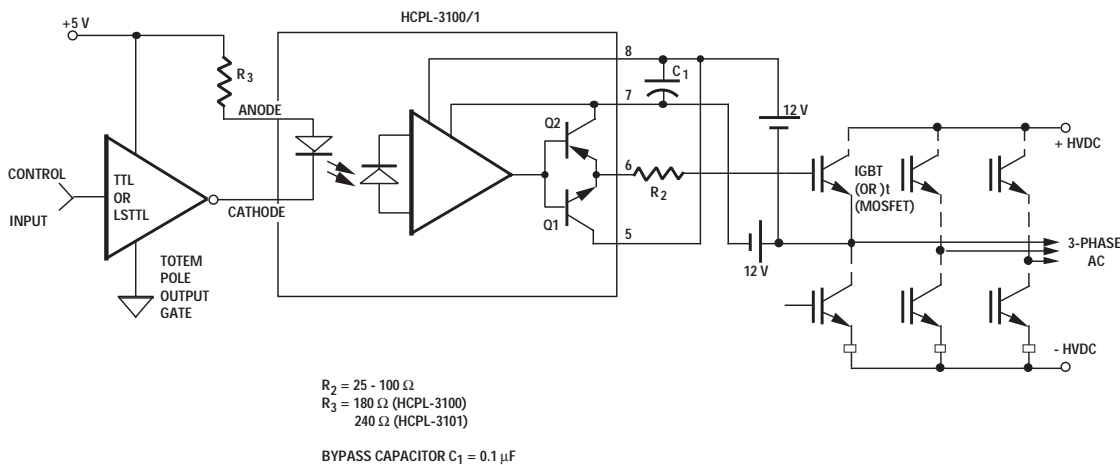

Figure 1. Recommended output transistor protection and typical application circuit.

Electrical Specifications

Over recommended temperature ($T_A = -40^\circ\text{C}$ to $+100^\circ\text{C}$, HCPL-3100; $T_A = -40^\circ\text{C}$ to $+85^\circ\text{C}$, HCPL-3101) unless otherwise specified.

Parameter		Sym.	Device	Min.	Typ.	Max.	Units	Test Conditions	Fig.	Note
Input Forward Voltage		V_F	HCPL-3100	-	1.2	1.4	V	$I_F = 20\text{ mA}$ $T_A = 25^\circ\text{C}$	13	
				0.6	0.9	-	V	$I_F = 0.2\text{ mA}$		
			HCPL-3101	-	1.6	1.75	V	$I_F = 10\text{ mA}$	14	
				1.2	1.5	-	V	$I_F = 0.2\text{ mA}$		
Input Reverse Current		I_R	HCPL-3100	-	-	10	μA	$V_R = 4\text{ V}$ $T_A = 25^\circ\text{C}$		
			HCPL-3101					$V_F = 5\text{ V}$		
Input Capacitance		C_{IN}	HCPL-3100	-	30	250	pF	$V_F = 0\text{ V}$, $f = 1\text{ kHz}$, $T_A = 25^\circ\text{C}$		
			HCPL-3101	-	60	150	pF	$V_F = 0\text{ V}$, $f = 1\text{ MHz}$, $T_A = 25^\circ\text{C}$		
Output 1	Low Level Voltage	V_{O1L}	HCPL-3100	-	0.2	0.4	V	$I_F = 10\text{ mA}$ $V_{CC1} = 12\text{ V}$, $I_{O1} = 0.1\text{ A}$, $V_{CC2} = -12\text{ V}$	2, 17, 18	2
	Leakage Current		HCPL-3101					$I_F = 5\text{ mA}$		
		I_{O1L}		-	-	500	μA	$V_{CC} = V_{O1} = 35\text{ V}$, $V_{O2} = 0\text{ V}$ $I_F = 0\text{ mA}$, $T_A = 25^\circ\text{C}$	5	
Output 2	High Level Voltage	V_{O2H}	HCPL-3100	20	22	-	V	$I_F = 10\text{ mA}$ $V_{CC} = 24\text{ V}$, $V_{O1} = 24\text{ V}$, $I_{O2} = -0.1\text{ A}$	3, 19, 20	2
	Low Level Voltage		HCPL-3101					$I_F = 5\text{ mA}$		
	Leakage Current	I_{O2L}	HCPL-3100	-	-	500	μA	$I_F = 10\text{ mA}$ $V_{CC} = 35\text{ V}$, $V_{O2} = 35\text{ V}$, $T_A = 25^\circ\text{C}$	6	
			HCPL-3101					$I_F = 5\text{ mA}$		
Supply Current	High Level	I_{CCH}	HCPL-3100	-	1.3	3.0	mA	$V_{O1} = 24\text{ V}$ $V_{CC} = 24\text{ V}$, $I_F = 10\text{ mA}$	7, 23	2
			HCPL-3101	-	1.3	3.0	mA	$V_{O1} = 24\text{ V}$ $V_{CC} = 24\text{ V}$, $I_F = 5\text{ mA}$		
	Low Level	I_{CCL}		-	1.3	3.0	mA	$V_{O1} = 24\text{ V}$ $V_{CC} = 24\text{ V}$, $I_F = 0\text{ mA}$	7, 24	
Low to High Threshold Input		I_{FLH}	HCPL-3100	1.0	4.0	7.0	mA	$T_A = 25^\circ\text{C}$	8, 15, 16	2, 3
				0.6	-	10.0	mA	$V_{CC} = V_{O1} = 24\text{ V}$		
			HCPL-3101	0.3	1.5	3.0	mA	$T_A = 25^\circ\text{C}$		
				0.2	-	5.0	mA	$V_{CC} = V_{O1} = 24\text{ V}$		

Switching Specifications ($T_A = 25^\circ\text{C}$)

Parameter	Sym.	Device	Min.	Typ.	Max.	Units	Test Conditions	Fig.	Note
Propagation Delay Time to High Output Level	t_{PLH}	HCPL-3100	-	1	2	μs	$I_F = 10\text{ mA}$	$V_{CC} = 24\text{ V}$, $V_{O1} = 24\text{ V}$, $R_G = 47\ \Omega$, $C_G = 3000\text{ pF}$	9, 25, 26, 27
		HCPL-3101	-	0.3	0.5	μs	$I_F = 5\text{ mA}$		
Propagation Delay Time to Low Output Level	t_{PHL}	HCPL-3100	-	1	2	μs	$I_F = 10\text{ mA}$		
		HCPL-3101	-	0.3	0.5	μs	$I_F = 5\text{ mA}$		
Rise Time	t_r	HCPL-3100	-	0.2	0.5	μs	$I_F = 10\text{ mA}$		
		HCPL-3101					$I_F = 5\text{ mA}$		
Fall Time	t_f	HCPL-3100	-	0.2	0.5	μs	$I_F = 10\text{ mA}$		
		HCPL-3101					$I_F = 5\text{ mA}$		
Output High Level Common Mode Transient Immunity	$ CM_H $	HCPL-3100	15		-	$\text{kV}/\mu\text{s}$	$I_F = 10\text{ mA}$	10	2
		HCPL-3101					$I_F = 5\text{ mA}$		
Output Low Level Common Mode Transient Immunity	$ CM_L $		15		-	$\text{kV}/\mu\text{s}$	$I_F = 0\text{ mA}$		

Packaging Characteristics

Parameter	Sym.	Min.	Typ.	Max.	Units	Test Conditions	Fig.	Note
Input-Output Momentary Withstand Voltage*	V_{ISO}	5000			V rms	RH = 40% to 60% $t = 1\text{ min}$, $T_A = 25^\circ\text{C}$		4, 5
Resistance (Input-Output)	R_{I-O}	5×10^{10}	10^{11}	-	Ω	$V_{I-O} = 500\text{ V}$, $T_A = 25^\circ\text{C}$ RH = 40% to 60%		4
Capacitance (Input-Output)	C_{I-O}	-	1.2	-	pF	$f = 1\text{ MHz}$		4

*The Input-Output Momentary Withstand Voltage is a dielectric voltage rating that should not be interpreted as an input-output continuous voltage rating. For the continuous voltage rating refer to the IEC/EN/DIN EN 60747-5-2 Insulation Characteristics Table (if applicable), your equipment level safety specification, or Avago Application Note 1074, "Optocoupler Input-Output Endurance Voltage."

Notes:

- Derate absolute maximum ratings with ambient temperatures as shown in Figures 11 and 12.
- A bypass capacitor of 0.01 μF or more is needed near the device between V_{CC} and GND when measuring output and transfer characteristics.
- I_{FLH} represents the forward current when the output goes from low to high.
- Device considered a two terminal device; pins 1-4 are shorted together and pins 5-8 are shorted together.
- For devices with minimum V_{ISO} specified at 5000 V rms, in accordance with UL 1577, each optocoupler is proof-tested by applying an insulation test voltage $\geq 6000\text{ V rms}$ for one second (leakage current detection limit, $I_{I-O} \leq 200\ \mu\text{A}$).
- The t_{PLH} and t_{PHL} propagation delays are measured from the 50% level of the input pulse to the 50% level of the output pulse.
- R_2 limits the Q1 and Q2 peak currents. For more applications and circuit design information see Application Note "Power Transistor Gate/Base Drive Optocouplers."

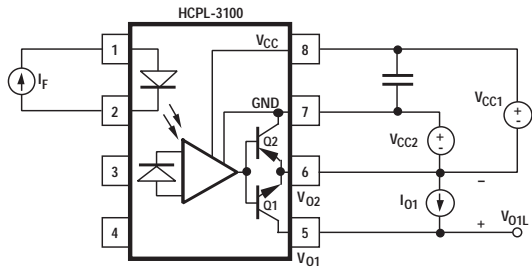

Figure 2. Test circuit for low level output voltage V_{O1L} .

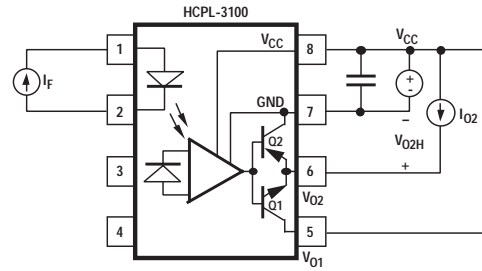

Figure 3. Test circuit for high level output voltage V_{O2H} .

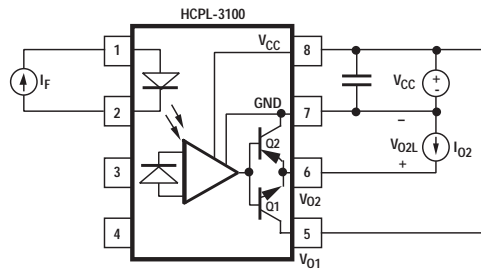

Figure 4. Test circuit for low level output voltage V_{O2L} .

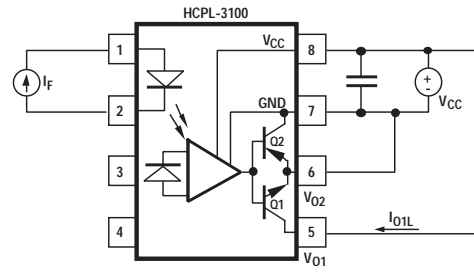

Figure 5. Test circuit for leakage current I_{O1L} .

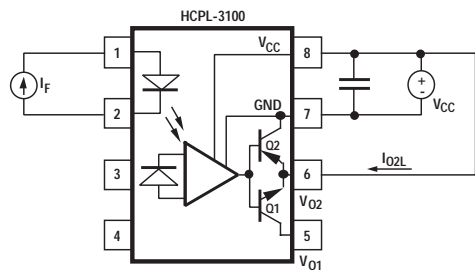

Figure 6. Test circuit for leakage current I_{O2L} .

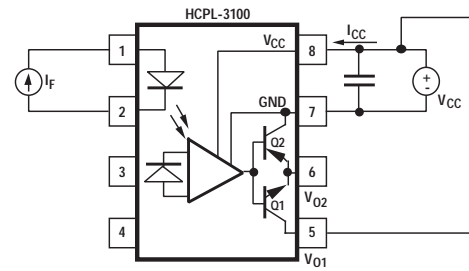

Figure 7. Test circuit for I_{CCH} and I_{CCL} .

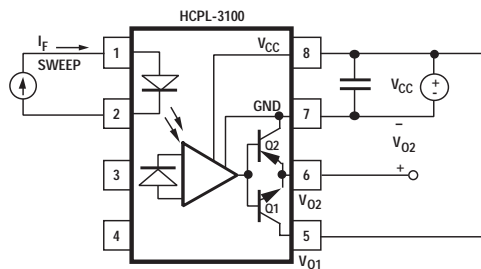

Figure 8. Test circuit for threshold input current I_{FLH} .

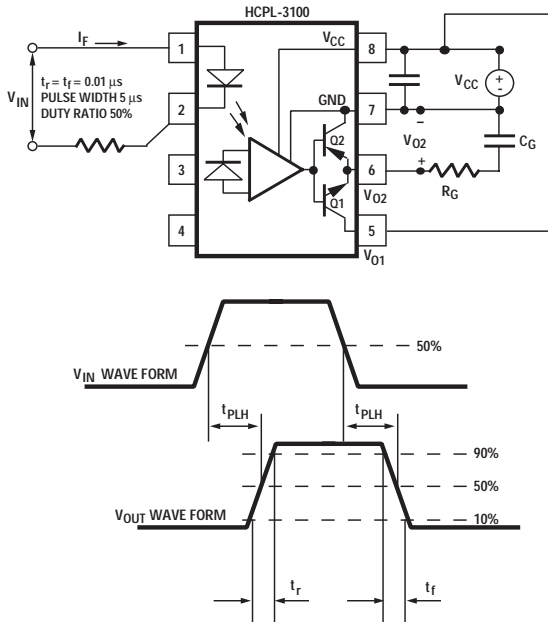

Figure 9. Test circuit for t_{PLH} , t_{PHL} , t_r , and t_f .

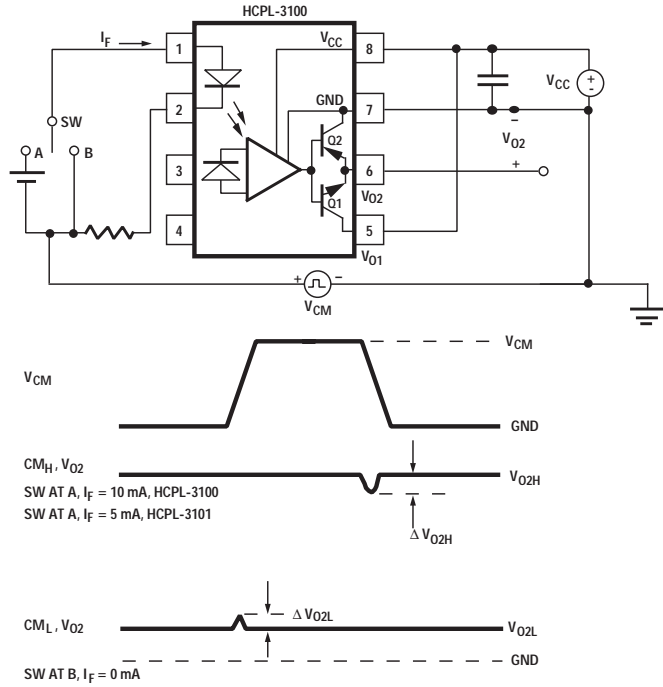

Figure 10. Test circuit for CM_H and CM_L .

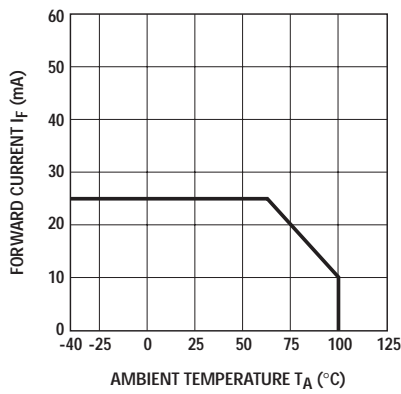

Figure 11. LED forward current vs. ambient temperature, HCPL-3100.

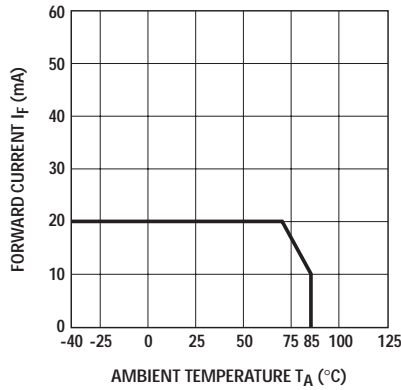

Figure 12. LED forward current vs. ambient temperature, HCPL-3101.

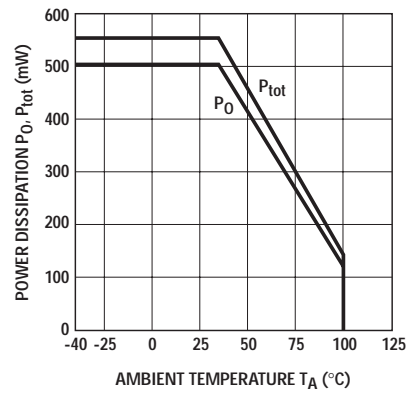

Figure 13. Maximum power dissipation vs. ambient temperature, HCPL-3100.

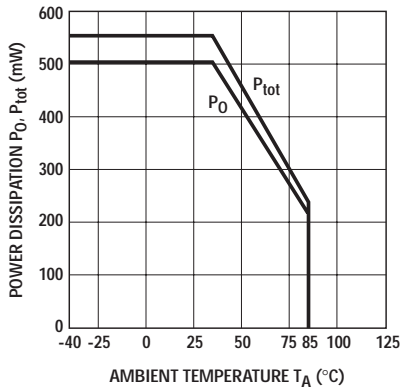

Figure 14. Maximum power dissipation vs. ambient temperature, HCPL-3101.

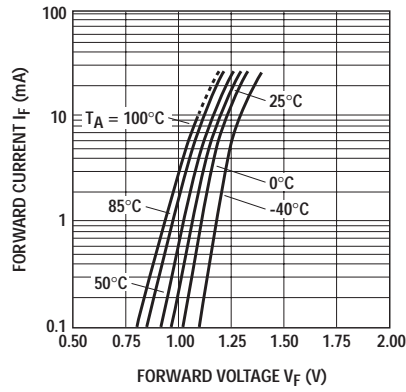

Figure 15. Typical forward current vs. forward voltage, HCPL-3100.

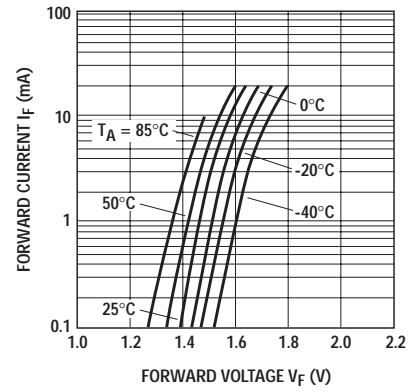

Figure 16. Typical forward current vs. forward voltage, HCPL-3101.

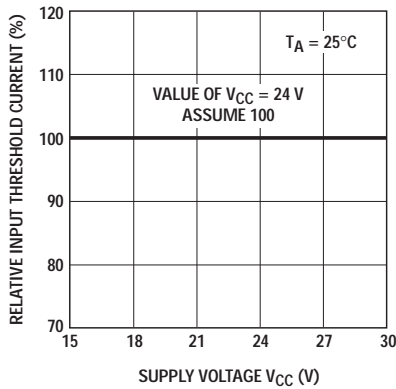

Figure 17. Normalized low to high threshold input current vs. supply voltage, HCPL-3100.

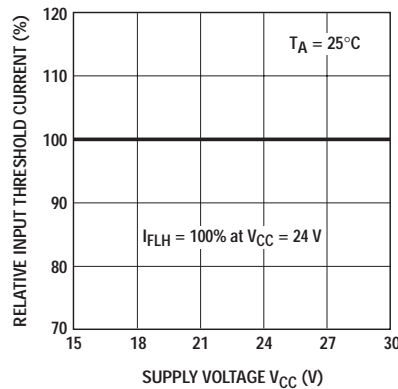

Figure 18. Normalized low to high threshold input current vs. supply voltage, HCPL-3101.

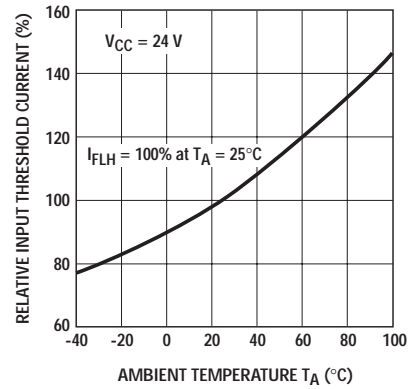

Figure 19. Normalized low to high threshold input current vs. ambient temperature, HCPL-3100.

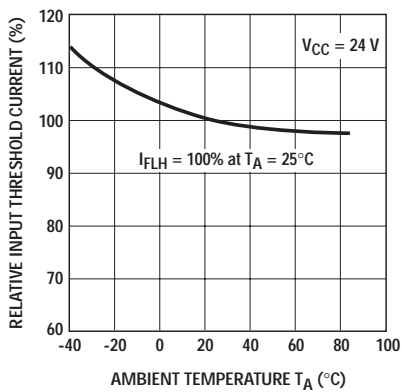

Figure 20. Normalized low to high threshold input current vs. ambient temperature, HCPL-3101.

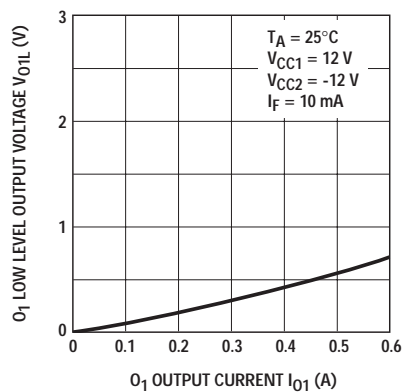

Figure 21. Typical low level output 1 voltage vs. output 1 current, HCPL-3100.

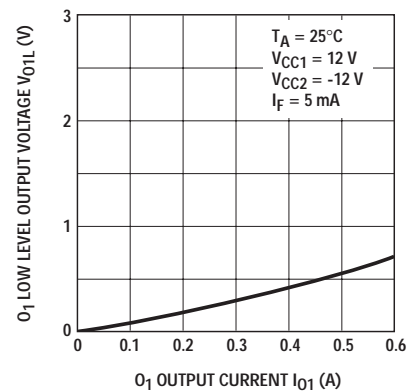

Figure 22. Typical low level output 1 voltage vs. output 1 current, HCPL-3101.

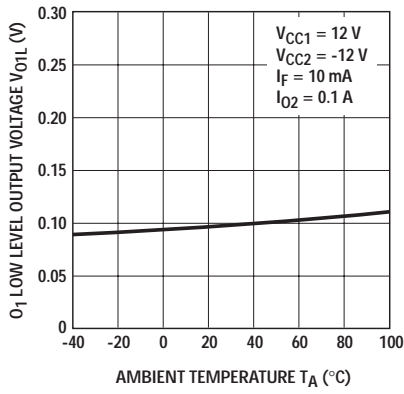

Figure 23. Typical low level output 1 voltage vs. ambient temperature, HCPL-3100.

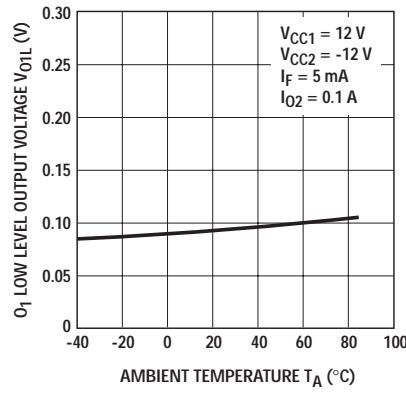

Figure 24. Typical low level output 1 voltage vs. ambient temperature, HCPL-3101.

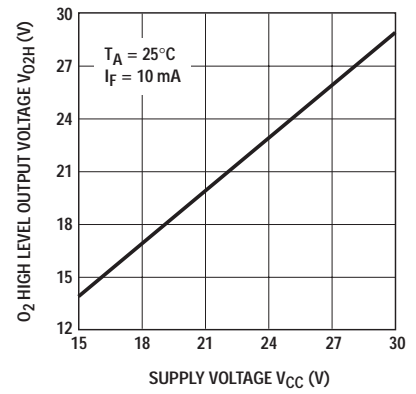

Figure 25. Typical high level output 2 voltage vs. supply voltage, HCPL-3100.

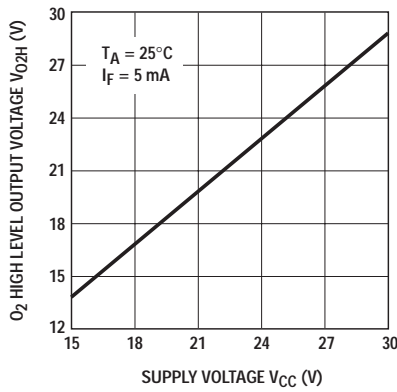

Figure 26. Typical high level output 2 voltage vs. supply voltage, HCPL-3101.

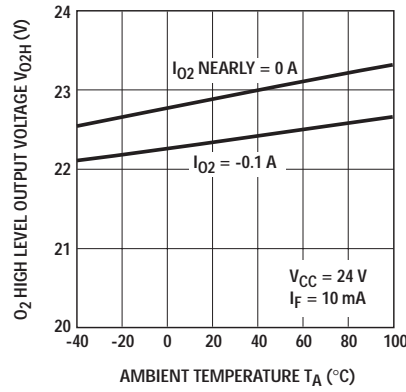

Figure 27. Typical high level output 2 voltage vs. ambient temperature, HCPL-3100.

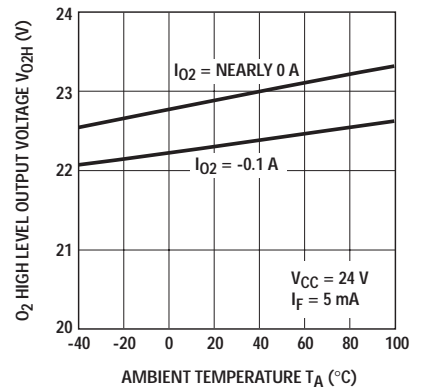

Figure 28. Typical high level output 2 voltage vs. ambient temperature, HCPL-3101.

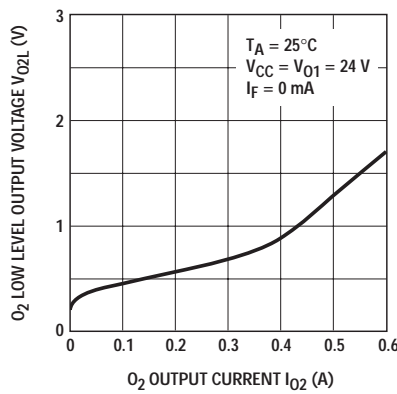

Figure 29. Typical low level output 2 voltage vs. output 2 current, HCPL-3100.

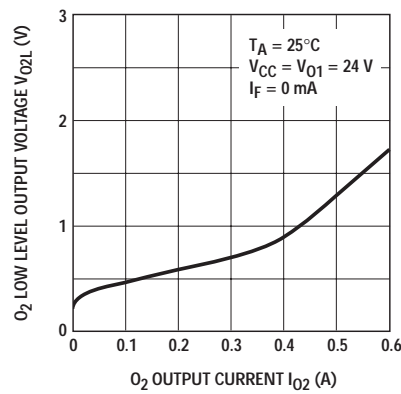

Figure 30. Typical low level output 2 voltage vs. output 2 current, HCPL-3101.

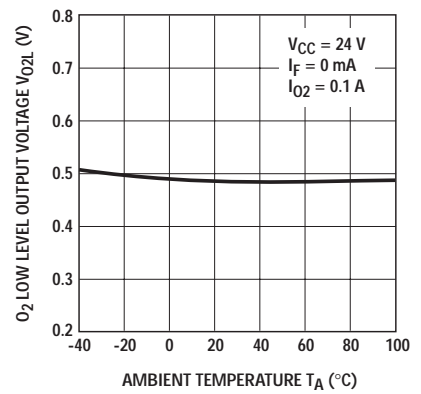

Figure 31. Typical low level output 2 voltage vs. ambient temperature, HCPL-3100.

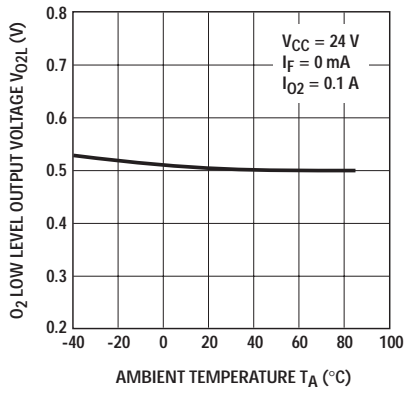

Figure 32. Typical low level output 2 voltage vs. ambient temperature, HCPL-3101.

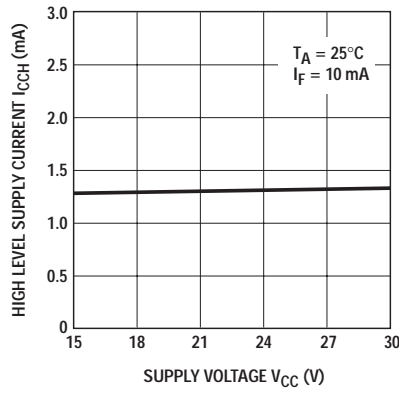

Figure 33. Typical high level supply current vs. supply voltage, HCPL-3100.

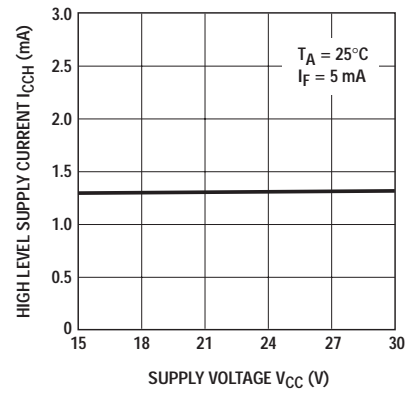

Figure 34. Typical high level supply current vs. supply voltage, HCPL-3101.

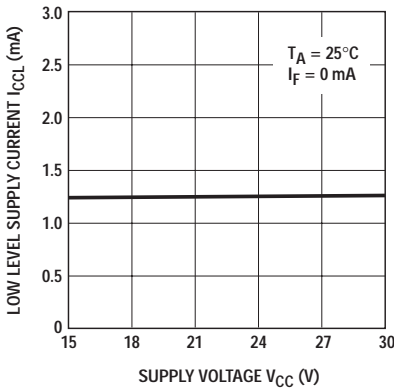

Figure 35. Typical low level supply current vs. supply voltage, HCPL-3100.

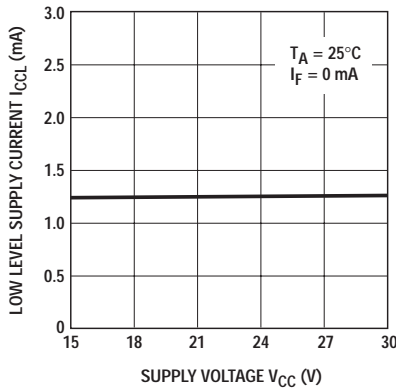

Figure 36. Typical low level supply current vs. supply voltage, HCPL-3101.

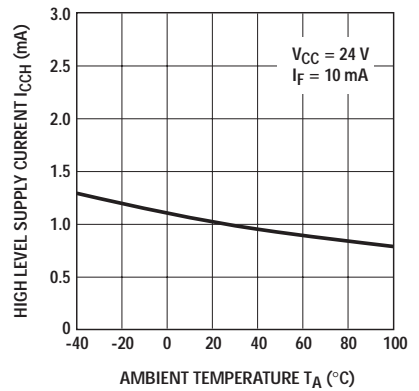

Figure 37. Typical high level supply current vs. ambient temperature, HCPL-3100.

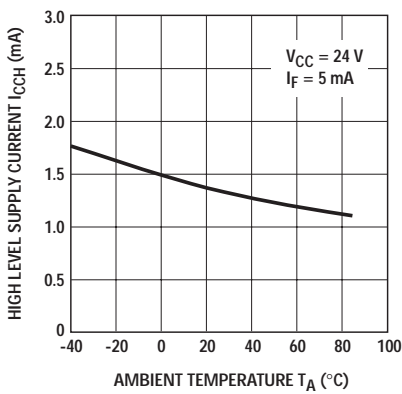

Figure 38. Typical high level supply current vs. ambient temperature, HCPL-3101.

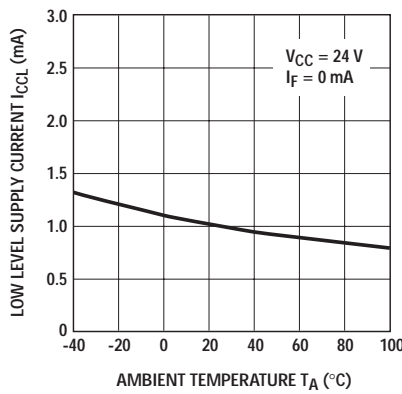

Figure 39. Typical low level supply current vs. ambient temperature, HCPL-3100.

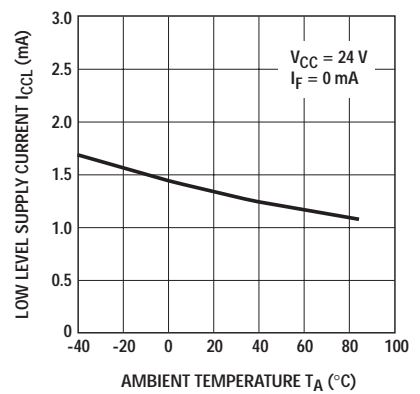

Figure 40. Typical low level supply current vs. ambient temperature, HCPL-3101.

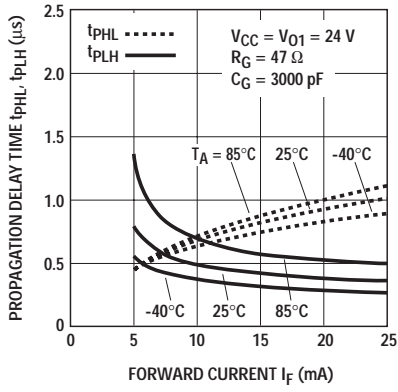

Figure 41. Typical propagation delay time vs. forward current, HCPL-3100.

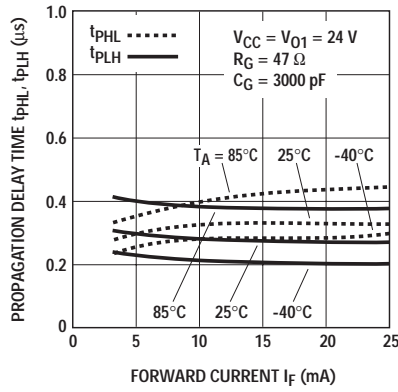

Figure 42. Typical propagation delay time vs. forward current, HCPL-3101.

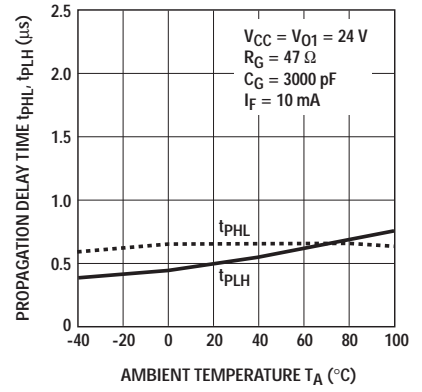

Figure 43. Typical propagation delay time vs. ambient temperature, HCPL-3100.

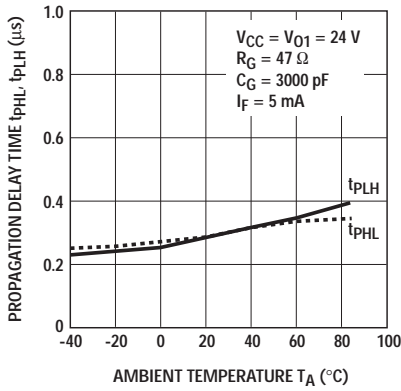

Figure 44. Typical propagation delay time vs. ambient temperature, HCPL-3101.

For product information and a complete list of distributors, please go to our website: www.avagotech.com

Avago, Avago Technologies, and the A logo are trademarks of Avago Technologies Limited in the United States and other countries.
Data subject to change. Copyright © 2007 Avago Technologies Limited. All rights reserved. Obsoletes 5989-2939EN
AV01-0573EN July 16, 2007

