

# FDBL86062-F085

## N-Channel POWERTRENCH<sup>®</sup> MOSFET

100 V, 300 A, 2.0 mΩ

### Features

- Typical  $R_{DS(on)} = 1.5 \text{ m}\Omega$  at  $V_{GS} = 10 \text{ V}$ ,  $I_D = 80 \text{ A}$
- Typical  $Q_{g(tot)} = 95 \text{ nC}$  at  $V_{GS} = 10 \text{ V}$ ,  $I_D = 80 \text{ A}$
- UIS Capability
- Qualified to AEC Q101
- This Device is Pb-Free and is RoHS Compliant

### Applications

- Automotive Engine Control
- PowerTrain Management
- Solenoid and Motor Drivers
- Integrated Starter/Alternator
- Primary Switch for 12 V Systems



**ON Semiconductor<sup>®</sup>**

[www.onsemi.com](http://www.onsemi.com)

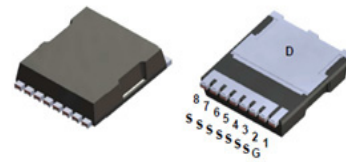
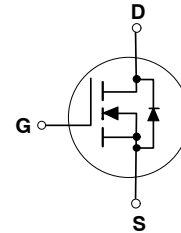

H-PSOF8L 11.68x9.80  
CASE 100CU

### MARKING DIAGRAM

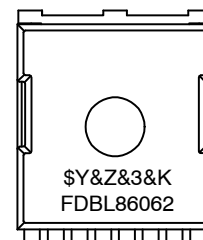

\$Y = ON Semiconductor Logo  
&Z&3 = Data Code (Year & Week)  
&K = Lot  
FDBL86062 = Specific Device Code

### ORDERING INFORMATION

See detailed ordering and shipping information on page 2 of this data sheet.

# FDBL86062–F085

## MOSFET MAXIMUM RATINGS $T_J = 25^\circ\text{C}$ unless otherwise noted

Symbol	Parameter	Rating	Units	
$V_{DSS}$	Drain-to-Source Voltage	100	V	
$V_{GS}$	Gate-to-Source Voltage	$\pm 20$	V	
$I_D$	Drain Current - Continuous ( $V_{GS} = 10$ ) (Note 1)	$T_C = 25^\circ\text{C}$	300	A
	Pulsed Drain Current	$T_C = 25^\circ\text{C}$	See Figure 4	
$E_{AS}$	Single Pulse Avalanche Energy (Note 2)	352	mJ	
$P_D$	Power Dissipation	429	W	
	Derate Above $25^\circ\text{C}$	2.9	W/ $^\circ\text{C}$	
$T_J, T_{STG}$	Operating and Storage Temperature	-55 to +175	$^\circ\text{C}$	
$R_{\theta JC}$	Thermal Resistance, Junction to Case	0.35	$^\circ\text{C}/\text{W}$	
$R_{\theta JA}$	Maximum Thermal Resistance, Junction to Ambient (Note 3)	43	$^\circ\text{C}/\text{W}$	

Stresses exceeding those listed in the Maximum Ratings table may damage the device. If any of these limits are exceeded, device functionality should not be assumed, damage may occur and reliability may be affected.

- Current is limited by silicon.
- Starting  $T_J = 25^\circ\text{C}$ ,  $L = 0.1$  mH,  $I_{AS} = 84$  A,  $V_{DD} = 100$  V during inductor charging and  $V_{DD} = 0$  V during time in avalanche.
- $R_{\theta JA}$  is the sum of the junction-to-case and case-to-ambient thermal resistance, where the case thermal reference is defined as the solder mounting surface of the drain pins.  $R_{\theta JC}$  is guaranteed by design, while  $R_{\theta JA}$  is determined by the board design. The maximum rating presented here is based on mounting on a 1 in<sup>2</sup> pad of 2oz copper.

## PACKAGE MARKING AND ORDERING INFORMATION

Device Marking	Device	Package	Reel Size	Tape Width	Quantity
FDBL86062	FDBL86062–F085	MO–299A	13"	24 mm	2000 Units

## ELECTRICAL CHARACTERISTICS $T_J = 25^\circ\text{C}$ , unless otherwise noted

Symbol	Parameter	Test Conditions	Min.	Typ.	Max.	Units
--------	-----------	-----------------	------	------	------	-------

### OFF CHARACTERISTICS

$B_{VDSS}$	Drain-to-Source Breakdown Voltage	$I_D = 250 \mu\text{A}, V_{GS} = 0$ V	100	–	–	V	
$I_{DSS}$	Drain-to-Source Leakage Current	$V_{DS} = 100$ V, $V_{GS} = 0$ V	$T_J = 25^\circ\text{C}$	–	–	5	$\mu\text{A}$
			$T_J = 175^\circ\text{C}$ (Note 4)	–	–	2	mA
$I_{GSS}$	Gate-to-Source Leakage Current	$V_{GS} = \pm 20$ V	–	–	$\pm 100$	nA	

### ON CHARACTERISTICS

$V_{GS(th)}$	Gate to Source Threshold Voltage	$V_{GS} = V_{DS}, I_D = 250 \mu\text{A}$	2.0	3.1	4.5	V	
$R_{DS(on)}$	Drain to Source On Resistance	$I_D = 80$ A, $V_{GS} = 10$ V	$T_J = 25^\circ\text{C}$	–	1.5	2.0	m $\Omega$
			$T_J = 175^\circ\text{C}$ (Note 4)	–	3.3	4.3	

### DYNAMIC CHARACTERISTICS

$C_{iss}$	Input Capacitance	$V_{DS} = 50$ V, $V_{GS} = 0$ V, $f = 1$ MHz	–	6970	–	pF	
$C_{oss}$	Output Capacitance		–	3950	–		
$C_{rss}$	Reverse Transfer Capacitance		–	29	–		
$R_g$	Gate Resistance	$f = 1$ MHz	–	0.4	–	$\Omega$	
$Q_{g(TOT)}$	Total Gate Charge at 10 V	$V_{GS} = 0$ to 10 V	$V_{DD} = 80$ V $I_D = 80$ A	–	95	124	nC
$Q_{g(th)}$	Threshold Gate Charge	$V_{GS} = 0$ to 2 V		–	13	–	
$Q_{gs}$	Gate-to-Source Gate Charge			–	31	–	
$Q_{gd}$	Gate-to-Drain "Miller" Charge			–	20	–	

## FDBL86062–F085

### ELECTRICAL CHARACTERISTICS (continued) $T_J = 25^\circ\text{C}$ , unless otherwise noted

Symbol	Parameter	Test Conditions	Min.	Typ.	Max.	Units
--------	-----------	-----------------	------	------	------	-------

#### SWITCHING CHARACTERISTICS

$t_{on}$	Turn-On Time	$V_{DD} = 50\text{ V}$ , $I_D = 80\text{ A}$ , $V_{GS} = 10\text{ V}$ , $R_{GEN} = 6\ \Omega$	–	–	73	ns
$t_{d(on)}$	Turn-On Delay		–	31	–	
$t_r$	Rise Time		–	25	–	
$t_{d(off)}$	Turn-Off Delay		–	36	–	
$t_f$	Fall Time		–	9	–	
$t_{off}$	Turn-Off Time		–	–	59	

#### DRAIN–SOURCE DIODE CHARACTERISTICS

$V_{SD}$	Source-to-Drain Diode Voltage	$I_{SD} = 80\text{ A}$ , $V_{GS} = 0\text{ V}$	–	–	1.25	V
		$I_{SD} = 40\text{ A}$ , $V_{GS} = 0\text{ V}$	–	–	1.2	
$t_{rr}$	Reverse-Recovery Time	$I_F = 80\text{ A}$ , $dI_{SD}/dt = 100\text{ A}/\mu\text{s}$ , $V_{DD} = 80\text{ V}$	–	115	150	ns
$Q_{rr}$	Reverse-Recovery Charge		–	172	224	nC

Product parametric performance is indicated in the Electrical Characteristics for the listed test conditions, unless otherwise noted. Product performance may not be indicated by the Electrical Characteristics if operated under different conditions.

4. The maximum value is specified by design at  $T_J = 175^\circ\text{C}$ . Product is not tested to this condition in production.

TYPICAL CHARACTERISTICS

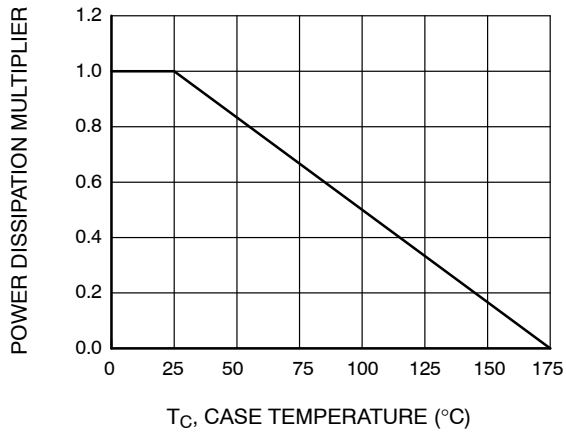

Figure 1. Normalized Power Dissipation vs. Case Temperature

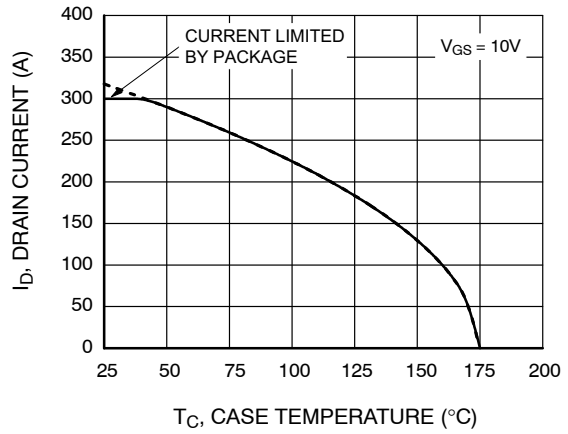

Figure 2. Maximum Continuous Drain Current vs. Case Temperature

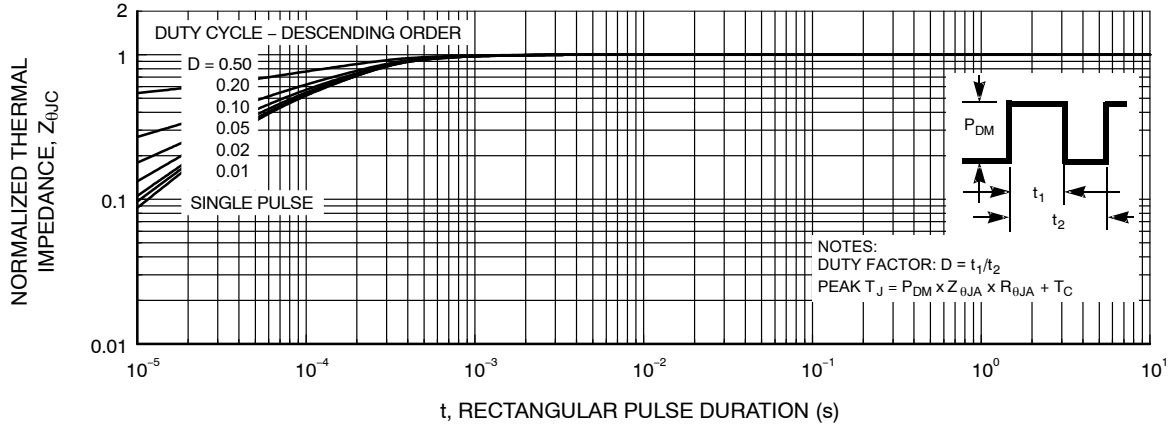

Figure 3. Normalized Maximum Transient Thermal Impedance

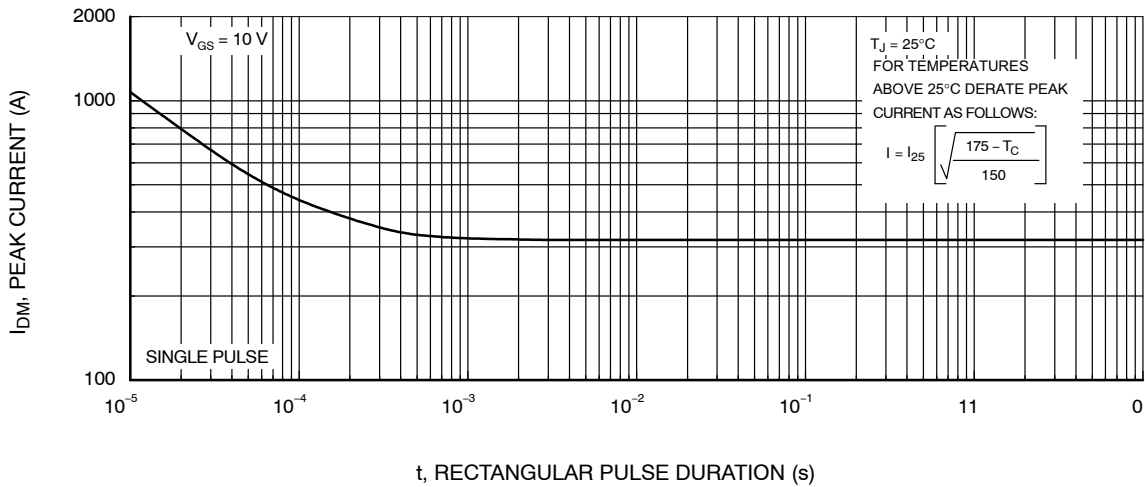

Figure 4. Peak Current Capability

TYPICAL CHARACTERISTICS (continued)

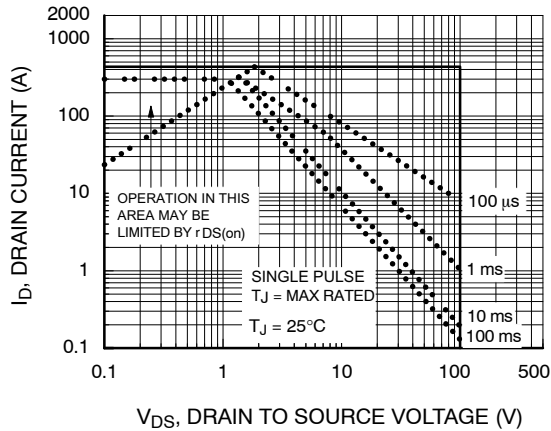
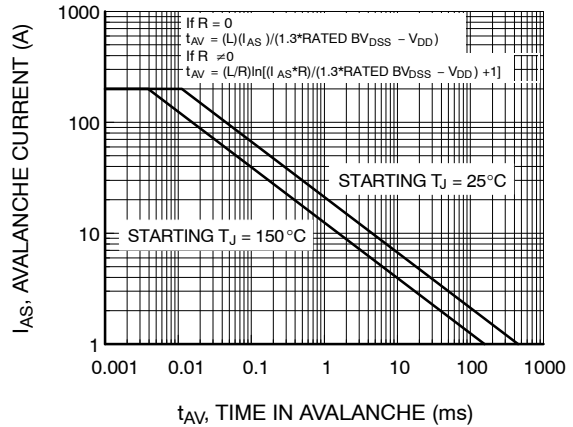

Figure 5. Forward Bias Safe Operating Area



NOTE: Refer to ON Semiconductor Application Notes AN7514 and AN7515

Figure 6. Unclamped Inductive Switching Capability

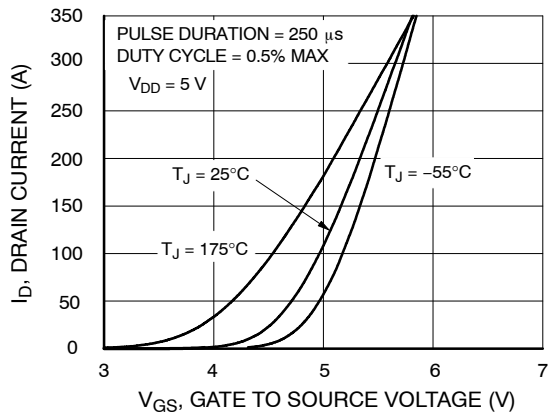

Figure 7. Transfer Characteristics

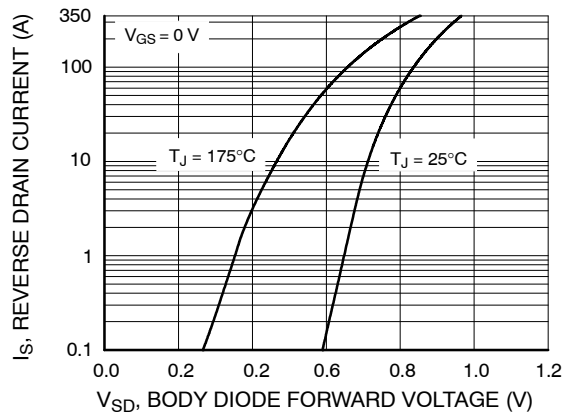

Figure 8. Forward Diode Characteristics

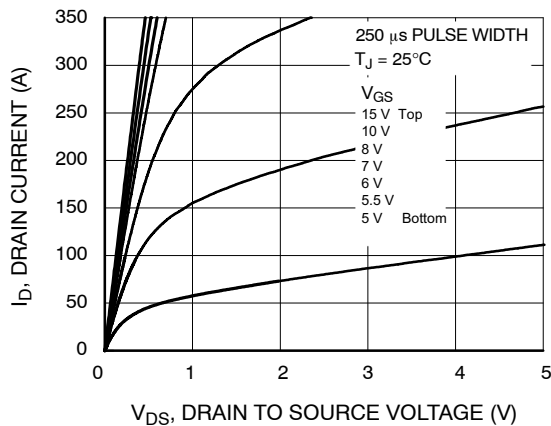

Figure 9. Saturation Characteristics

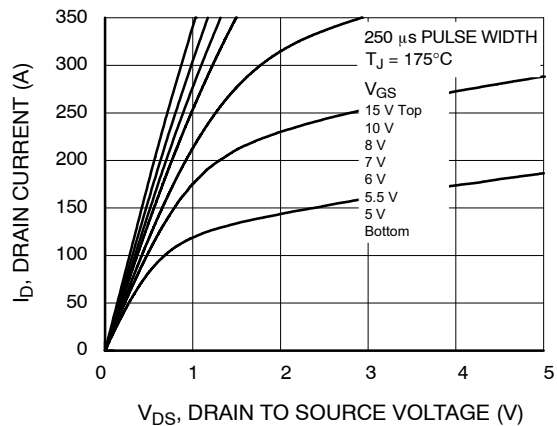

Figure 10. Saturation Characteristics

TYPICAL CHARACTERISTICS (continued)

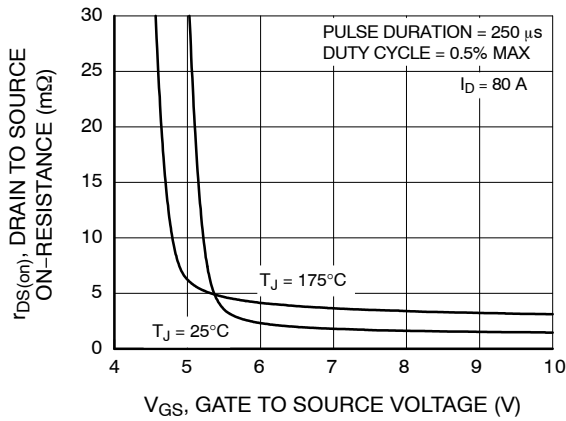

Figure 11.  $R_{DS(on)}$  vs. Gate Voltage

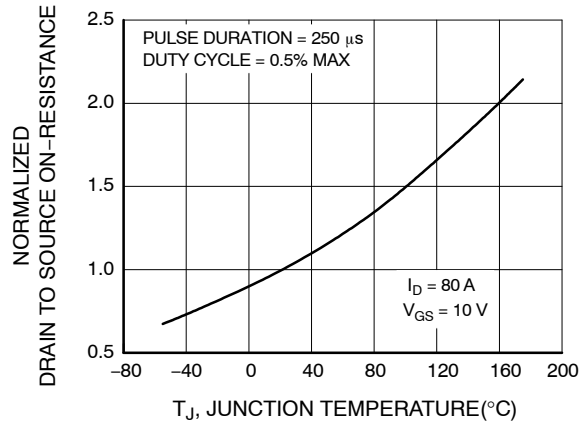

Figure 12. Normalized  $R_{DS(on)}$  vs. Junction Temperature

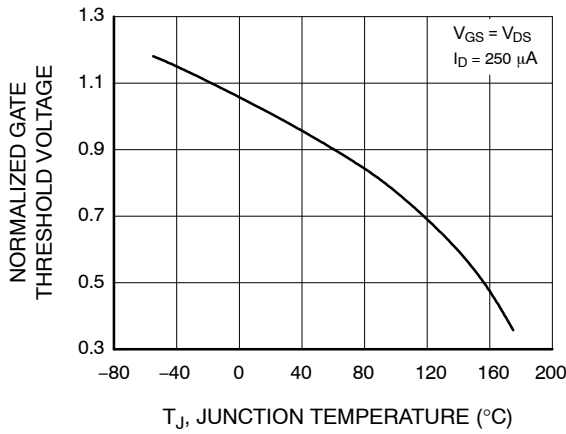

Figure 13. Normalized Gate Threshold Voltage vs. Temperature

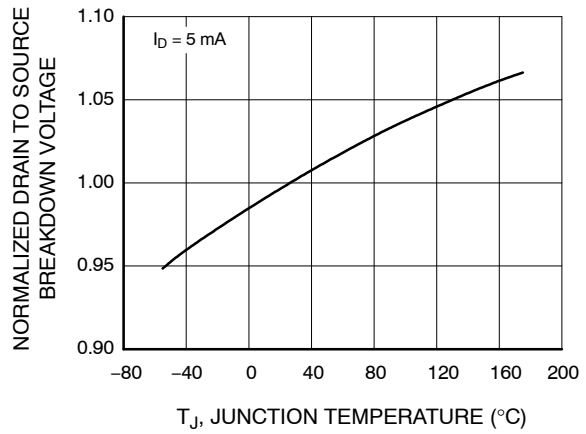

Figure 14. Normalized Drain to Source Breakdown Voltage vs. Junction Temperature

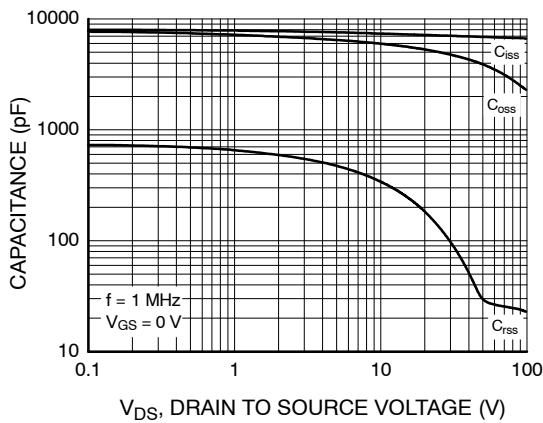

Figure 15. Capacitance vs. Drain to Source Voltage

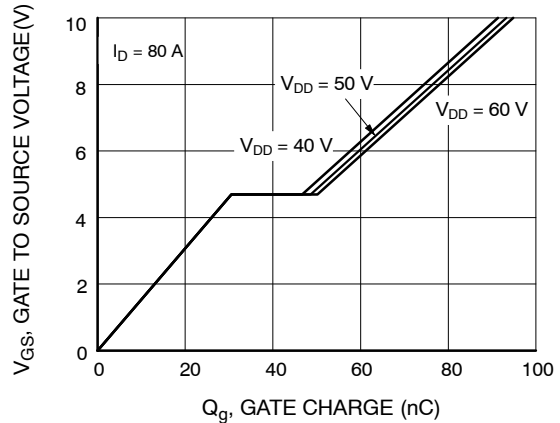

Figure 16. Gate Charge vs. Gate to Source Voltage

POWERTRENCH is registered trademarks of Semiconductor Components Industries, LLC (SCILLC) or its subsidiaries in the United States and/or other countries.

# MECHANICAL CASE OUTLINE PACKAGE DIMENSIONS

ON Semiconductor®



## H-PSOF8L 11.68x9.80 CASE 100CU ISSUE A

DATE 06 JAN 2020

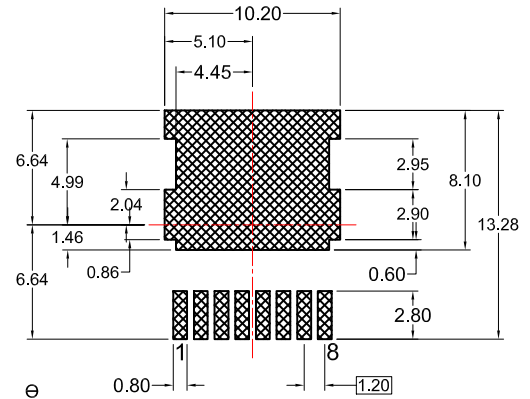
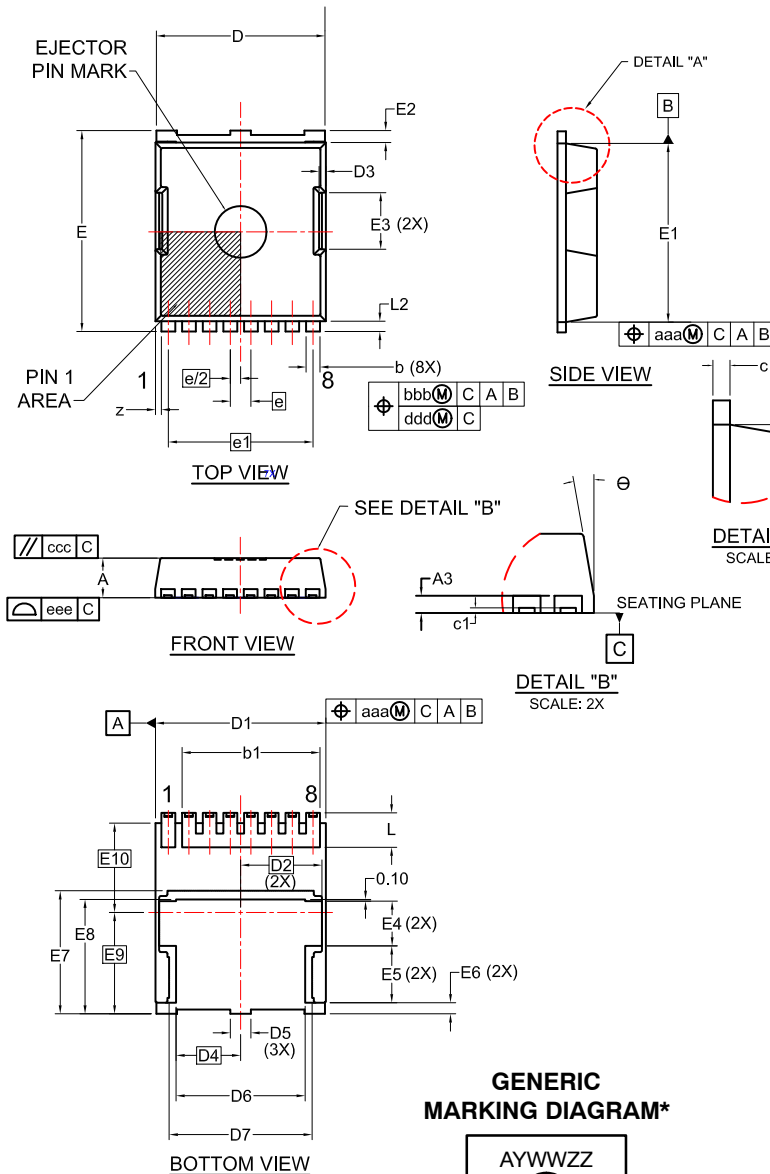

**LAND PATTERN RECOMMENDATION**  
\*FOR ADDITIONAL INFORMATION ON OUR PB-FREE STRATEGY AND SOLDERING DETAILS, PLEASE DOWNLOAD THE ON SEMICONDUCTOR SOLDERING AND MOUNTING TECHNIQUES REFERENCE MANUAL, SOLDERRM/D.

**NOTES:**

1. PACKAGE STANDARD REFERENCE: JEDEC MO-299, ISSUE A.
2. DIMENSIONING AND TOLERANCING PER ASME Y14.5M, 2009.
3. CONTROLLING DIMENSION: MILLIMETERS.
4. COPLANARITY APPLIES TO THE EXPOSED WELL AS THE TERMINALS.
5. DIMENSIONS D1 AND E1 DO NOT INCLUDE MOLD FLASH, PROTRUSIONS, OR GATE BURRS.
6. SEATING PLANE IS DEFINED BY THE TERMINALS. "A1" IS DEFINED AS THE DISTANCE FROM THE SEATING PLANE TO THE LOWEST POINT ON THE PACKAGE BODY.

DIM	MILLIMETERS		
	MIN.	NOM.	MAX.
A	2.20	2.30	2.40
A3	0.40	0.50	0.60
b	0.70	0.80	0.90
b1	8.00 REF		
c	0.40	0.50	0.60
c1	0.10	--	--
D	9.70	9.80	9.90
D1	9.80	9.90	10.00
D2	4.73 BSC		
D3	0.40 REF		
D4	3.75 BSC		
D5	--	1.20	--
D6	7.40	7.50	7.60
D7	(8.30)		
E	11.58	11.68	11.78
E1	10.28	10.38	10.48
E2	0.60	0.70	0.80
E3	3.30 REF		
E4	--	2.60	--

DIM	MILLIMETERS		
	MIN.	NOM.	MAX.
e	1.20 BSC		
e/2	0.60 BSC		
e1	8.40 BSC		
K	1.50	1.57	1.70
L	1.90	2.00	2.10
L2	0.50	0.60	0.70
z	0.35 REF		
θ	0°	--	12°
aaa	0.20		
bbb	0.25		
ccc	0.20		
ddd	0.20		
eee	0.10		
E5	--	3.30	--
E6	--	0.65	--
E7	7.15 REF		
E8	6.55	6.65	6.75
E9	5.89 BSC		
E10	5.19 BSC		

### GENERIC MARKING DIAGRAM\*

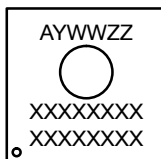

A = Assembly Location  
Y = Year  
WW = Work Week  
ZZ = Assembly Lot Code  
XXXX = Specific Device Code

\*This information is generic. Please refer to device data sheet for actual part marking. Pb-Free indicator, "G" or microdot "•", may or may not be present. Some products may not follow the Generic Marking.

<b>DOCUMENT NUMBER:</b>	<b>98AON13813G</b>	Electronic versions are uncontrolled except when accessed directly from the Document Repository. Printed versions are uncontrolled except when stamped "CONTROLLED COPY" in red.
<b>DESCRIPTION:</b>	<b>H-PSOF8L 11.68x9.80</b>	<b>PAGE 1 OF 1</b>

ON Semiconductor and ON are trademarks of Semiconductor Components Industries, LLC dba ON Semiconductor or its subsidiaries in the United States and/or other countries. ON Semiconductor reserves the right to make changes without further notice to any products herein. ON Semiconductor makes no warranty, representation or guarantee regarding the suitability of its products for any particular purpose, nor does ON Semiconductor assume any liability arising out of the application or use of any product or circuit, and specifically disclaims any and all liability, including without limitation special, consequential or incidental damages. ON Semiconductor does not convey any license under its patent rights nor the rights of others.

ON Semiconductor and  are trademarks of Semiconductor Components Industries, LLC dba ON Semiconductor or its subsidiaries in the United States and/or other countries. ON Semiconductor owns the rights to a number of patents, trademarks, copyrights, trade secrets, and other intellectual property. A listing of ON Semiconductor's product/patent coverage may be accessed at [www.onsemi.com/site/pdf/Patent-Marking.pdf](http://www.onsemi.com/site/pdf/Patent-Marking.pdf). ON Semiconductor reserves the right to make changes without further notice to any products herein. ON Semiconductor makes no warranty, representation or guarantee regarding the suitability of its products for any particular purpose, nor does ON Semiconductor assume any liability arising out of the application or use of any product or circuit, and specifically disclaims any and all liability, including without limitation special, consequential or incidental damages. Buyer is responsible for its products and applications using ON Semiconductor products, including compliance with all laws, regulations and safety requirements or standards, regardless of any support or applications information provided by ON Semiconductor. "Typical" parameters which may be provided in ON Semiconductor data sheets and/or specifications can and do vary in different applications and actual performance may vary over time. All operating parameters, including "Typicals" must be validated for each customer application by customer's technical experts. ON Semiconductor does not convey any license under its patent rights nor the rights of others. ON Semiconductor products are not designed, intended, or authorized for use as a critical component in life support systems or any FDA Class 3 medical devices or medical devices with a same or similar classification in a foreign jurisdiction or any devices intended for implantation in the human body. Should Buyer purchase or use ON Semiconductor products for any such unintended or unauthorized application, Buyer shall indemnify and hold ON Semiconductor and its officers, employees, subsidiaries, affiliates, and distributors harmless against all claims, costs, damages, and expenses, and reasonable attorney fees arising out of, directly or indirectly, any claim of personal injury or death associated with such unintended or unauthorized use, even if such claim alleges that ON Semiconductor was negligent regarding the design or manufacture of the part. ON Semiconductor is an Equal Opportunity/Affirmative Action Employer. This literature is subject to all applicable copyright laws and is not for resale in any manner.

## PUBLICATION ORDERING INFORMATION

### LITERATURE FULFILLMENT:

Email Requests to: [orderlit@onsemi.com](mailto:orderlit@onsemi.com)

ON Semiconductor Website: [www.onsemi.com](http://www.onsemi.com)

### TECHNICAL SUPPORT

North American Technical Support:  
Voice Mail: 1 800-282-9855 Toll Free USA/Canada  
Phone: 011 421 33 790 2910

### Europe, Middle East and Africa Technical Support:

Phone: 00421 33 790 2910

For additional information, please contact your local Sales Representative