

Programmable LVDS Transmitter 24-Bit Flat Panel Display (FPD) Link-65 MHz

Check for Samples: [DS90C383B](#)

FEATURES

- No special start-up sequence required between clock/data and /PD pins. Input signal (clock and data) can be applied either before or after the device is powered
- Support Spread Spectrum Clocking up to 100kHz frequency modulation and deviations of $\pm 2.5\%$ center spread or -5% down spread
- "Input Clock Detection" feature will pull all LVDS pairs to logic low when input clock is missing and when /PD pin is logic high
- 18 to 68 MHz shift clock support
- Best-in-Class Setup and Hold Times on TxINPUTs
- Tx power consumption < 130 mW (typ) at 65MHz Grayscale
- 40% Less Power Dissipation than BiCMOS Alternatives
- Tx Power-down mode < 60 μ W (typ)
- Supports VGA, SVGA, XGA and Dual Pixel SXGA.
- Narrow bus reduces cable size and cost
- Up to 1.8 Gbps throughput
- Up to 227 Megabytes/sec bandwidth
- 345 mV (typ) swing LVDS devices for low EMI

- PLL requires no external components
- Compatible with TIA/EIA-644 LVDS standard
- Low profile 56-lead TSSOP package
- Improved replacement for:
 - SN75LVDS83, DS90C383A

DESCRIPTION

The DS90C383B transmitter converts 28 bits of CMOS/TTL data into four LVDS (Low Voltage Differential Signaling) data streams. A phase-locked transmit clock is transmitted in parallel with the data streams over a fifth LVDS link. Every cycle of the transmit clock 28 bits of input data are sampled and transmitted. At a transmit clock frequency of 65 MHz, 24 bits of RGB data and 3 bits of LCD timing and control data (FPLINE, FPFRAME, DRDY) are transmitted at a rate of 455 Mbps per LVDS data channel. Using a 65 MHz clock, the data throughput is 227 Mbytes/sec. The DS90C383B transmitter can be programmed for Rising edge strobe or Falling edge strobe through a dedicated pin. A Rising edge or Falling edge strobe transmitter will interoperate with a Falling edge strobe Receiver (DS90CF386) without any translation logic.

This chipset is an ideal means to solve EMI and cable size problems associated with wide, high speed TTL interfaces.

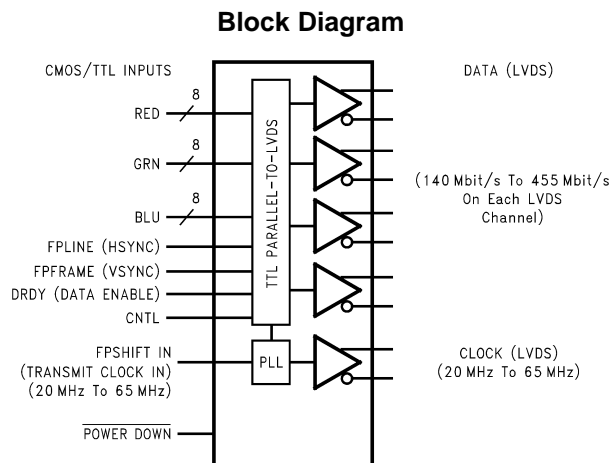

Figure 1. DS90C383B



Please be aware that an important notice concerning availability, standard warranty, and use in critical applications of Texas Instruments semiconductor products and disclaimers thereto appears at the end of this data sheet.

TRI-STATE is a registered trademark of Texas Instruments.
All other trademarks are the property of their respective owners.



These devices have limited built-in ESD protection. The leads should be shorted together or the device placed in conductive foam during storage or handling to prevent electrostatic damage to the MOS gates.

Absolute Maximum Ratings ⁽¹⁾

Supply Voltage (V_{CC})		-0.3V to +4 V
CMOS/TTL Input Voltage		-0.3V to ($V_{CC} + 0.3$) V
LVDS Driver Output Voltage		-0.3V to ($V_{CC} + 0.3$) V
LVDS Output Short Circuit Duration		Continuous
Junction Temperature		+150 °C
Storage Temperature		-65°C to +150 °C
Lead Temperature (Soldering, 4 seconds)		+260 °C
Maximum Package Power Dissipation Capacity at 25°C	TSSOP Package	1.63 W
Package Derating		12.5 mW/°C above +25°C
ESD Rating	HBM, 1.5 k Ω , 100 pF	7 kV
	EIAJ, 0 Ω , 200 pF	500 V

(1) "Absolute Maximum Ratings" are those values beyond which the safety of the device cannot be verified. They are not meant to imply that the device should be operated at these limits. The tables of "Electrical Characteristics" specify conditions for device operation.

Recommended Operating Conditions

	Min	Nom	Max	Unit
Supply Voltage (V_{CC})	3.0	3.3	3.6	V
Operating Free Air Temperature (T_A)	-10	+25	+70	°C
Supply Noise Voltage (V_{CC})			200	mV _{PP}
TxCLKIN frequency	18		68	MHz

Electrical Characteristics ⁽¹⁾

Over recommended operating supply and temperature ranges unless otherwise specified.

Symbol	Parameter	Conditions	Min	Typ ⁽²⁾	Max	Unit
CMOS/TTL DC SPECIFICATIONS						
V_{IH}	High Level Input Voltage		2.0		V_{CC}	V
V_{IL}	Low Level Input Voltage		GND		0.8	V
V_{CL}	Input Clamp Voltage	$I_{CL} = -18$ mA		-0.79	-1.5	V
I_{IN}	Input Current	$V_{IN} = 0.4V, 2.5V$ or V_{CC}		+1.8	+10	μ A
		$V_{IN} = GND$	-10	0		μ A
LVDS DC SPECIFICATIONS						
V_{OD}	Differential Output Voltage	$R_L = 100\Omega$	250	345	450	mV
ΔV_{OD}	Change in V_{OD} between complimentary output states				35	mV
V_{OS}	Offset Voltage ⁽³⁾		1.13	1.25	1.38	V
ΔV_{OS}	Change in V_{OS} between complimentary output states				35	mV
I_{OS}	Output Short Circuit Current	$V_{OUT} = 0V, R_L = 100\Omega$		-3.5	-5	mA
I_{OZ}	Output TRI-STATE [®] Current	Power Down = 0V, $V_{OUT} = 0V$ or V_{CC}		± 1	± 10	μ A

(1) Current into device pins is defined as positive. Current out of device pins is defined as negative. Voltages are referenced to ground unless otherwise specified (except V_{OD} and ΔV_{OD}).

(2) Typical values are given for $V_{CC} = 3.3V$ and $T_A = +25^\circ C$ unless specified otherwise.

(3) V_{OS} previously referred as V_{CM} .

Electrical Characteristics⁽¹⁾ (continued)

Over recommended operating supply and temperature ranges unless otherwise specified.

Symbol	Parameter	Conditions	Min	Typ ⁽²⁾	Max	Unit	
TRANSMITTER SUPPLY CURRENT							
ICCTW	Transmitter Supply Current, Worst Case	R _L = 100Ω, C _L = 5 pF, Worst Case Pattern (Figure 2 Figure 5) "Typ" values are given for V _{CC} = 3.6V and T _A = +25°C, " Max " values are given for V _{CC} = 3.6V and T _A = -10°C	f = 25MHz		31	45	mA
			f = 40MHz		37	50	mA
			f = 65 MHz		48	60	mA
ICCTG	Transmitter Supply Current, 16 Grayscale	R _L = 100Ω, C _L = 5 pF, 16 Grayscale Pattern (Figure 3 Figure 5) "Typ" values are given for V _{CC} = 3.6V and T _A = +25°C, " Max " values are given for V _{CC} = 3.6V and T _A = -10°C	f = 25MHz		29	40	mA
			f = 40MHz		33	45	mA
			f = 65 MHz		39	50	mA
ICCTZ	Transmitter Supply Current, Power Down	Power Down = Low Driver Outputs in TRI-STATE® under Power Down Mode		17	150	μA	

Recommended Transmitter Input Characteristics

Over recommended operating supply and temperature ranges unless otherwise specified

Symbol	Parameter	Min	Typ	Max	Unit
TCIT	TxCLK IN Transition Time (Figure 6)			5	ns
TCIP	TxCLK IN Period (Figure 7)	14.7	T	50	ns
TCIH	TxCLK IN High Time (Figure 7)	0.35T	0.5T	0.65T	ns
TCIL	TxCLK IN Low Time (Figure 7)	0.35T	0.5T	0.65T	ns
TXIT	TxIN, and Power Down pins Transition Time	1.5		6.0	ns
TXPD	Minimum pulse width for Power Down pin signal	1			us

Transmitter Switching Characteristics

Over recommended operating supply and temperature ranges unless otherwise specified

Symbol	Parameter	Min	Typ	Max	Unit	
LLHT	LVDS Low-to-High Transition Time (Figure 5)		0.75	1.4	ns	
LHLT	LVDS High-to-Low Transition Time (Figure 5)		0.75	1.4	ns	
TPPos0	Transmitter Output Pulse Position for Bit 0 (Figure 12) ⁽¹⁾	f = 65 MHz	-0.20	0	+0.20	ns
TPPos1	Transmitter Output Pulse Position for Bit 1		2.00	2.20	2.40	ns
TPPos2	Transmitter Output Pulse Position for Bit 2		4.20	4.40	4.60	ns
TPPos3	Transmitter Output Pulse Position for Bit 3		6.39	6.59	6.79	ns
TPPos4	Transmitter Output Pulse Position for Bit 4		8.59	8.79	8.99	ns
TPPos5	Transmitter Output Pulse Position for Bit 5		10.79	10.99	11.19	ns
TPPos6	Transmitter Output Pulse Position for Bit 6		12.99	13.19	13.39	ns

(1) The Minimum and Maximum Limits are based on statistical analysis of the device performance over process, voltage, and temperature ranges. This parameter is functionality tested only on Automatic Test Equipment (ATE).

Transmitter Switching Characteristics (continued)

Over recommended operating supply and temperature ranges unless otherwise specified

Symbol	Parameter	Min	Typ	Max	Unit	
TPPos0	Transmitter Output Pulse Position for Bit 0 (Figure 12) ⁽¹⁾	f = 40 MHz	-0.25	0	+0.25	ns
TPPos1	Transmitter Output Pulse Position for Bit 1		3.32	3.57	3.82	ns
TPPos2	Transmitter Output Pulse Position for Bit 2		6.89	7.14	7.39	ns
TPPos3	Transmitter Output Pulse Position for Bit 3		10.46	10.71	10.96	ns
TPPos4	Transmitter Output Pulse Position for Bit 4		14.04	14.29	14.54	ns
TPPos5	Transmitter Output Pulse Position for Bit 5		17.61	17.86	18.11	ns
TPPos6	Transmitter Output Pulse Position for Bit 6		21.18	21.43	21.68	ns
TPPos0	Transmitter Output Pulse Position for Bit 0 (Figure 12) ⁽¹⁾	f = 25MHz	-0.45	0	+0.45	ns
TPPos1	Transmitter Output Pulse Position for Bit 1		5.26	5.71	6.16	ns
TPPos2	Transmitter Output Pulse Position for Bit 2		10.98	11.43	11.88	ns
TPPos3	Transmitter Output Pulse Position for Bit 3		16.69	17.14	17.59	ns
TPPos4	Transmitter Output Pulse Position for Bit 4		22.41	22.86	23.31	ns
TPPos5	Transmitter Output Pulse Position for Bit 5		25.12	28.57	29.02	ns
TPPos6	Transmitter Output Pulse Position for Bit 6		33.84	34.29	34.74	ns
TSTC	TxIN Setup to TxCLK IN (Figure 7)	2.5			ns	
THTC	TxIN Hold to TxCLK IN (Figure 7)	0.5			ns	
TCCD	TxCLK IN to TxCLK OUT Delay (Figure 8) 50% duty cycle input clock is assumed, T _A = -10°C, and 65MHz for "Min", T _A = 70°C, and 25MHz for "Max", V _{CC} = 3.6V, R _{FB} = V _{CC}	3.340		7.211	ns	
	TxCLK IN to TxCLK OUT Delay (Figure 8) 50% duty cycle input clock is assumed, T _A = -10°C, and 65MHz for "Min", T _A = 70°C, and 25MHz for "Max", V _{CC} = 3.6V, R _{FB} = GND	3.011		6.062	ns	
SSCG	Spread Spectrum Clock support; Modulation frequency with a linear profile ⁽²⁾ .	f = 25MHz		100kHz ± 2.5%/-5%		
		f = 40MHz		100kHz ± 2.5%/-5%		
		f = 65MHz		100kHz ± 2.5%/-5%		
TPLLS	Transmitter Phase Lock Loop Set (Figure 9)			10	ms	
TPDD	Transmitter Power Down Delay (Figure 11)			100	ns	

(2) Care must be taken to ensure TSTC and THTC are met so input data are sampling correctly. This SSCG parameter only shows the performance of tracking Spread Spectrum Clock applied to TxCLK IN pin, and reflects the result on TxCLKOUT+ and TxCLK- pins.

AC Timing Diagrams

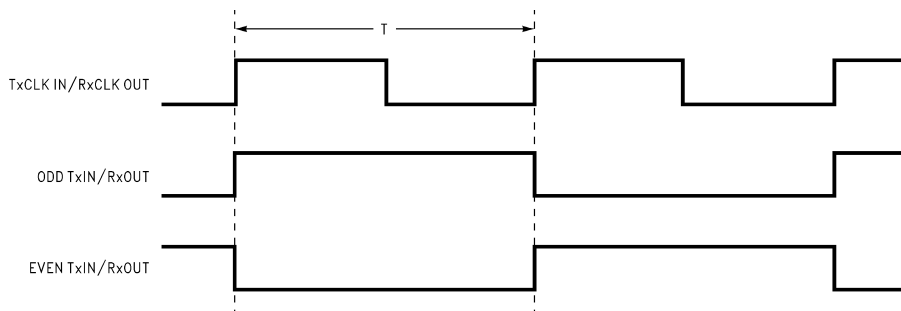

- A. The worst case test pattern produces a maximum toggling of digital circuits, LVDS I/O and CMOS/TTL I/O.
- B. Figure 2 and Figure 3 show a falling edge data strobe (TxCLK IN/RxCLK OUT).

Figure 2. "Worst Case" Test Pattern

AC Timing Diagrams (continued)

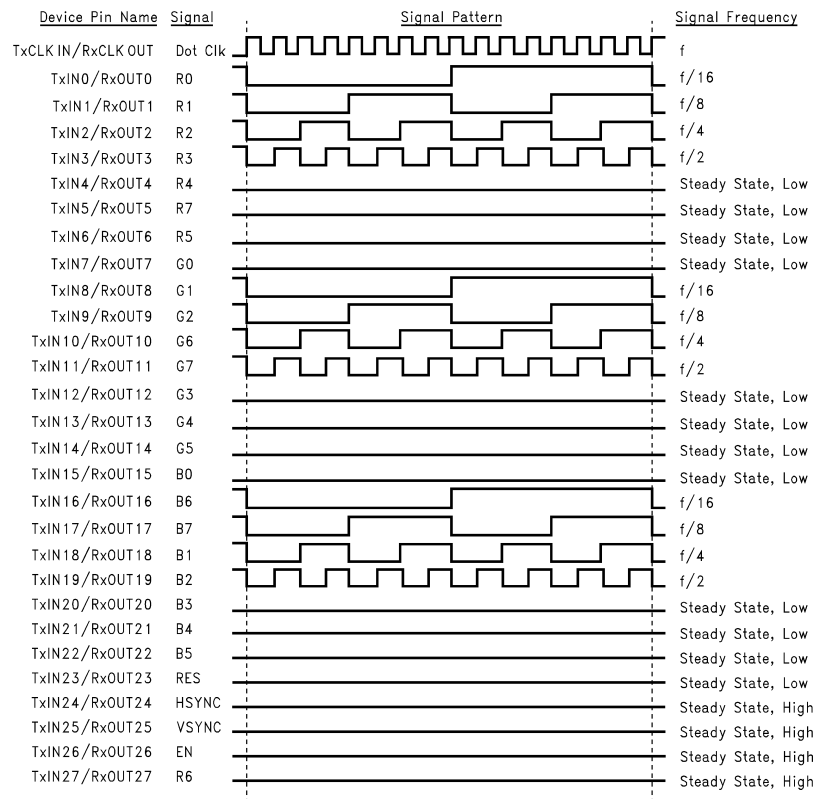

- A. The 16 grayscale test pattern tests device power consumption for a “typical” LCD display pattern. The test pattern approximates signal switching needed to produce groups of 16 vertical stripes across the display.
- B. Figure 2 and Figure 3 show a falling edge data strobe (TxCLK IN/RxCLK OUT).
- C. Recommended pin to signal mapping. Customer may choose to define differently.

Figure 3. “16 Grayscale” Test Pattern

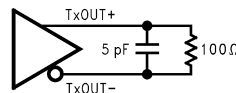

Figure 4. DS90C383B (Transmitter) LVDS Output Load

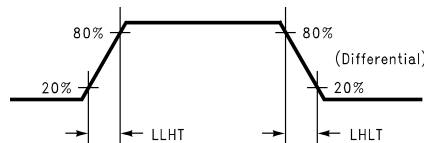

Figure 5. DS90C383B (Transmitter) LVDS Transition Times

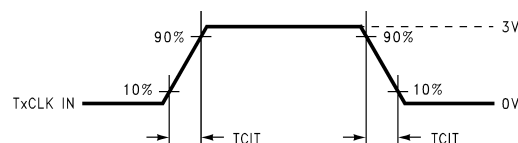

Figure 6. DS90C383B (Transmitter) Input Clock Transition Time

AC Timing Diagrams (continued)

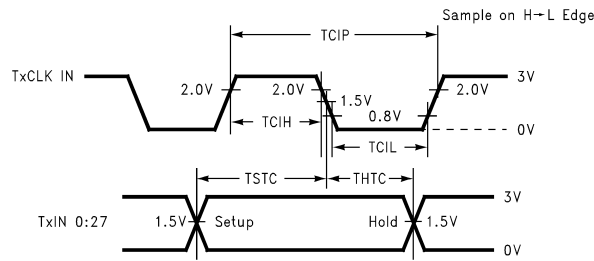

Figure 7. DS90C383B (Transmitter) Setup/Hold and High/Low Times (Falling Edge Strobe)

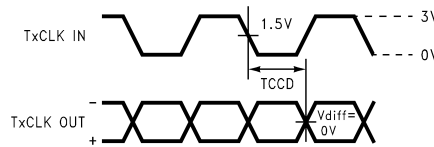

Figure 8. DS90C383B (Transmitter) Clock In to Clock Out Delay (Falling Edge Strobe)

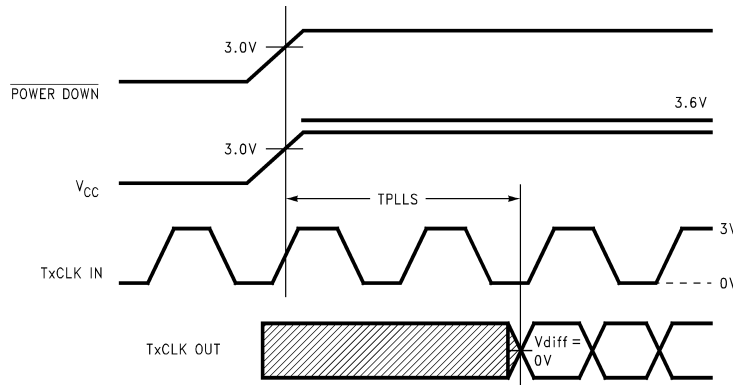

Figure 9. DS90C383B (Transmitter) Phase Lock Loop Set Time

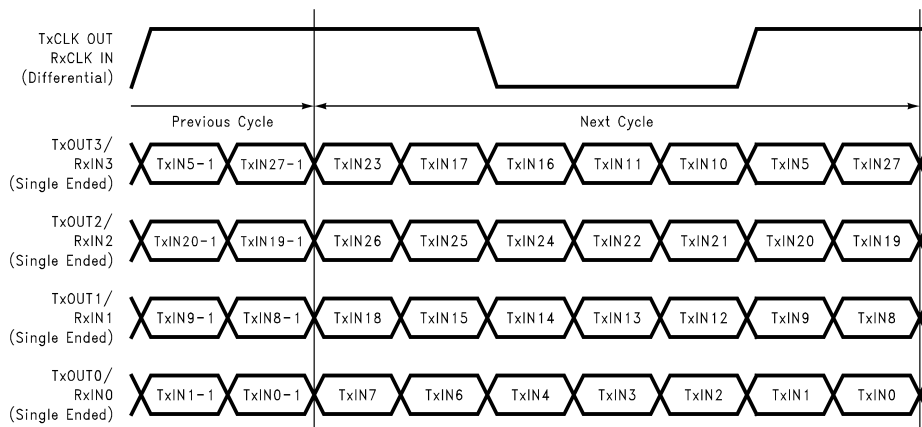

Figure 10. 28 Parallel TTL Data Inputs Mapped to LVDS Outputs

AC Timing Diagrams (continued)

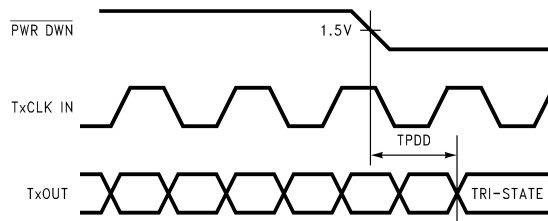

Figure 11. Transmitter Power Down Delay

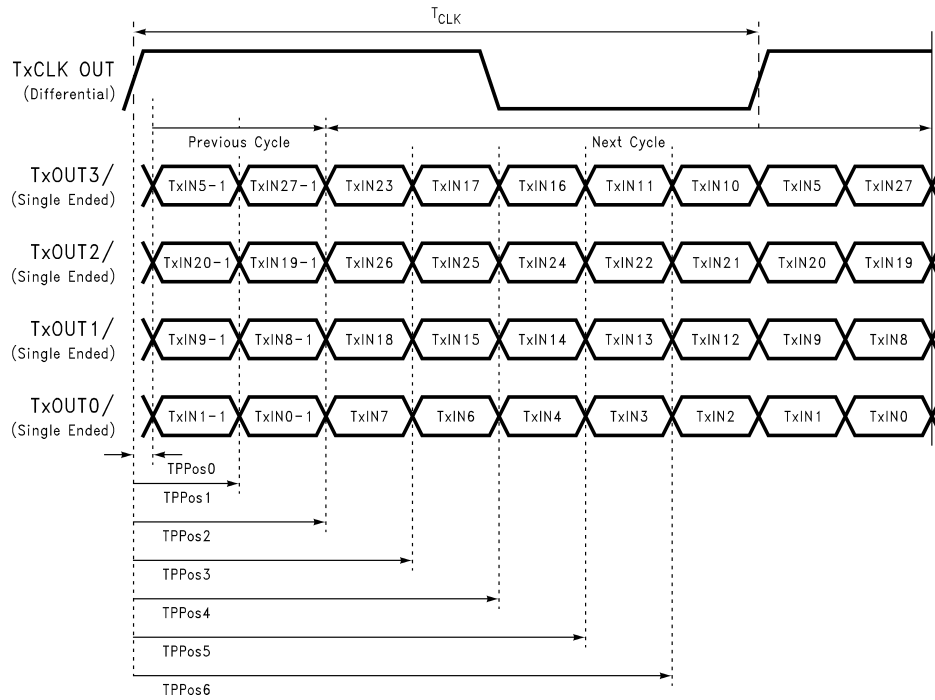

Figure 12. Transmitter LVDS Output Pulse Position Measurement

DS90C383B Pin Description—FPD Link Transmitter

Pin Name	I/O	No.	Description
TxIN	I	28	TTL level input. This includes: 8 Red, 8 Green, 8 Blue, and 4 control lines—FPLINE, FPFRAME and DRDY (also referred to as HSYNC, VSYNC, Data Enable).
TxOUT+	O	4	Positive LVDS differential data output.
TxOUT-	O	4	Negative LVDS differential data output.
FPSHIFT IN	I	1	TTL level clock input. The falling edge acts as data strobe. Pin name TxCLK IN.
R_FB	I	1	Programmable strobe select (See Table 1).
TxCLK OUT+	O	1	Positive LVDS differential clock output.
TxCLK OUT-	O	1	Negative LVDS differential clock output.
PWR DOWN	I	1	TTL level input. Assertion (low input) TRI-STATES the outputs, ensuring low current at power down. See Applications Information .
V _{CC}	I	3	Power supply pins for TTL inputs.
GND	I	5	Ground pins for TTL inputs.
PLL V _{CC}	I	1	Power supply pin for PLL.
PLL GND	I	2	Ground pins for PLL.
LVDS V _{CC}	I	1	Power supply pin for LVDS outputs.
LVDS GND	I	3	Ground pins for LVDS outputs.

APPLICATIONS INFORMATION

The DS90C383B are backward compatible with the DS90C383/DS90CF383, DS90C383A/DS90CF383A and are a pin-for-pin replacement.

This device may also be used as a replacement for the DS90CF583 (5V, 65MHz) and DS90CF581 (5V, 40MHz) FPD-Link Transmitters with certain considerations/modifications:

1. Change 5V power supply to 3.3V. Provide this supply to the V_{CC}, LVDS V_{CC} and PLL V_{CC} of the transmitter.
2. The DS90C383B transmitter input and control inputs accept 3.3V LVTTTL/LVCMOS levels. They are not 5V tolerant.
3. To implement a falling edge device for the DS90C383B, the R_FB pin (pin 17) may be tied to ground OR left unconnected (an internal pull-down resistor biases this pin low). Biasing this pin to V_{CC} implements a rising edge device.

TRANSMITTER INPUT PINS

The TxIN and control input pins are compatible with LVCMOS and LVTTTL levels. These pins are not 5V tolerant.

TRANSMITTER INPUT CLOCK/DATA SEQUENCING

The DS90C383B does not require any special requirement for sequencing of the input clock/data and PD (PowerDown) signal. The DS90C383B offers a more robust input sequencing feature where the input clock/data can be inserted after the release of the PD signal. In the case where the clock/data is stopped and reapplied, such as changing video mode within Graphics Controller, it is not necessary to cycle the PD signal. However, there are in certain cases where the PD may need to be asserted during these mode changes. In cases where the source (Graphics Source) may be supplying an unstable clock or spurious noisy clock output to the LVDS transmitter, the LVDS Transmitter may attempt to lock onto this unstable clock signal but is unable to do so due the instability or quality of the clock source. The PD signal in these cases should then be asserted once a stable clock is applied to the LVDS transmitter. Asserting the PWR DOWN pin will effectively place the device in reset and disable the PLL, enabling the LVDS Transmitter into a power saving standby mode. However, it is still generally a good practice to assert the PWR DOWN pin or reset the LVDS transmitter whenever the clock/data is stopped and reapplied but it is not mandatory for the DS90C383B.

SPREAD SPECTRUM CLOCK SUPPORT

The DS90C383B can support Spread Spectrum Clocking signal type inputs. The DS90C383B outputs will accurately track Spread Spectrum Clock/Data inputs with modulation frequencies of up to 100kHz (max.) with either center spread of $\pm 2.5\%$ or down spread -5% deviations.

POWER SOURCES SEQUENCE

In typical applications, it is recommended to have V_{CC} , LVDS V_{CC} and PLL V_{CC} from the same power source with three separate de-coupling bypass capacitor groups. There is no requirement on which VCC entering the device first.

Pin Diagram

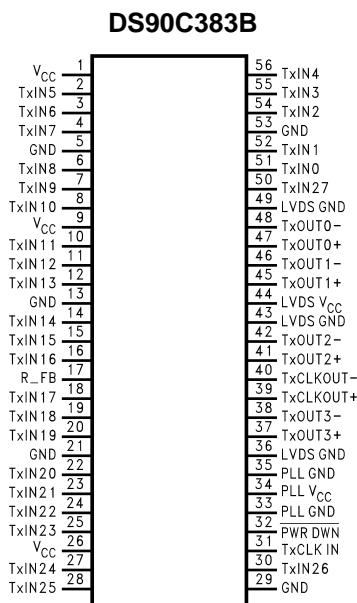

**Order Number DS90C383BMT
DGG Package**

Block Diagram

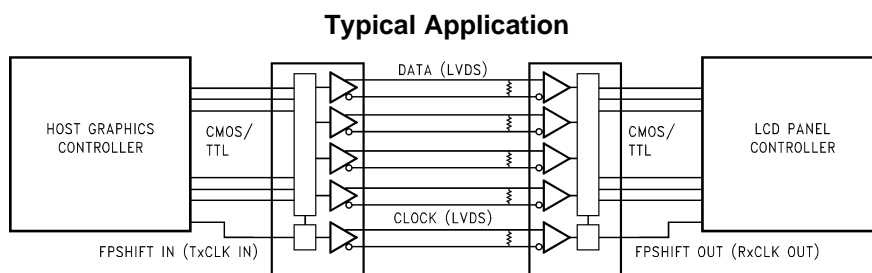

Table 1. Programmable Transmitter (DS90C383B)

Pin	Condition	Strobe Status
R_FB	R_FB = V_{CC}	Rising edge strobe
R_FB	R_FB = GND or NC	Falling edge strobe

REVISION HISTORY

Changes from Revision F (April 2013) to Revision G	Page
• Changed layout of National Data Sheet to TI format	9

PACKAGING INFORMATION

Orderable Device	Status (1)	Package Type	Package Drawing	Pins	Package Qty	Eco Plan (2)	Lead/Ball Finish	MSL Peak Temp (3)	Op Temp (°C)	Top-Side Markings (4)	Samples
DS90C383BMT/NOPB	ACTIVE	TSSOP	DGG	56	34	Green (RoHS & no Sb/Br)	CU SN	Level-2-260C-1 YEAR	-10 to 70	DS90C383BMT	Samples
DS90C383BMTX/NOPB	ACTIVE	TSSOP	DGG	56	1000	Green (RoHS & no Sb/Br)	CU SN	Level-2-260C-1 YEAR	-10 to 70	DS90C383BMT	Samples
DS90CF383BMT/NOPB	ACTIVE	TSSOP	DGG	56	34	Green (RoHS & no Sb/Br)	CU SN	Level-2-260C-1 YEAR	-10 to 70	DS90CF383BMT	Samples

(1) The marketing status values are defined as follows:

ACTIVE: Product device recommended for new designs.

LIFEBUY: TI has announced that the device will be discontinued, and a lifetime-buy period is in effect.

NRND: Not recommended for new designs. Device is in production to support existing customers, but TI does not recommend using this part in a new design.

PREVIEW: Device has been announced but is not in production. Samples may or may not be available.

OBSOLETE: TI has discontinued the production of the device.

(2) Eco Plan - The planned eco-friendly classification: Pb-Free (RoHS), Pb-Free (RoHS Exempt), or Green (RoHS & no Sb/Br) - please check <http://www.ti.com/productcontent> for the latest availability information and additional product content details.

TBD: The Pb-Free/Green conversion plan has not been defined.

Pb-Free (RoHS): TI's terms "Lead-Free" or "Pb-Free" mean semiconductor products that are compatible with the current RoHS requirements for all 6 substances, including the requirement that lead not exceed 0.1% by weight in homogeneous materials. Where designed to be soldered at high temperatures, TI Pb-Free products are suitable for use in specified lead-free processes.

Pb-Free (RoHS Exempt): This component has a RoHS exemption for either 1) lead-based flip-chip solder bumps used between the die and package, or 2) lead-based die adhesive used between the die and leadframe. The component is otherwise considered Pb-Free (RoHS compatible) as defined above.

Green (RoHS & no Sb/Br): TI defines "Green" to mean Pb-Free (RoHS compatible), and free of Bromine (Br) and Antimony (Sb) based flame retardants (Br or Sb do not exceed 0.1% by weight in homogeneous material)

(3) MSL, Peak Temp. -- The Moisture Sensitivity Level rating according to the JEDEC industry standard classifications, and peak solder temperature.

(4) Multiple Top-Side Markings will be inside parentheses. Only one Top-Side Marking contained in parentheses and separated by a "~" will appear on a device. If a line is indented then it is a continuation of the previous line and the two combined represent the entire Top-Side Marking for that device.

Important Information and Disclaimer: The information provided on this page represents TI's knowledge and belief as of the date that it is provided. TI bases its knowledge and belief on information provided by third parties, and makes no representation or warranty as to the accuracy of such information. Efforts are underway to better integrate information from third parties. TI has taken and continues to take reasonable steps to provide representative and accurate information but may not have conducted destructive testing or chemical analysis on incoming materials and chemicals. TI and TI suppliers consider certain information to be proprietary, and thus CAS numbers and other limited information may not be available for release.

In no event shall TI's liability arising out of such information exceed the total purchase price of the TI part(s) at issue in this document sold by TI to Customer on an annual basis.

TAPE AND REEL INFORMATION



QUADRANT ASSIGNMENTS FOR PIN 1 ORIENTATION IN TAPE



*All dimensions are nominal

Device	Package Type	Package Drawing	Pins	SPQ	Reel Diameter (mm)	Reel Width W1 (mm)	A0 (mm)	B0 (mm)	K0 (mm)	P1 (mm)	W (mm)	Pin1 Quadrant
DS90C383BMTX/NOPB	TSSOP	DGG	56	1000	330.0	24.4	8.6	14.5	1.8	12.0	24.0	Q1

TAPE AND REEL BOX DIMENSIONS



*All dimensions are nominal

Device	Package Type	Package Drawing	Pins	SPQ	Length (mm)	Width (mm)	Height (mm)
DS90C383BMTX/NOPB	TSSOP	DGG	56	1000	367.0	367.0	45.0



4222167/A 07/2015

NOTES:

1. All linear dimensions are in millimeters. Any dimensions in parenthesis are for reference only. Dimensioning and tolerancing per ASME Y14.5M.
2. This drawing is subject to change without notice.
3. This dimension does not include mold flash, protrusions, or gate burrs. Mold flash, protrusions, or gate burrs shall not exceed 0.15 mm per side.
4. Reference JEDEC registration MO-153.

EXAMPLE BOARD LAYOUT

DGG0056A

TSSOP - 1.2 mm max height

SMALL OUTLINE PACKAGE

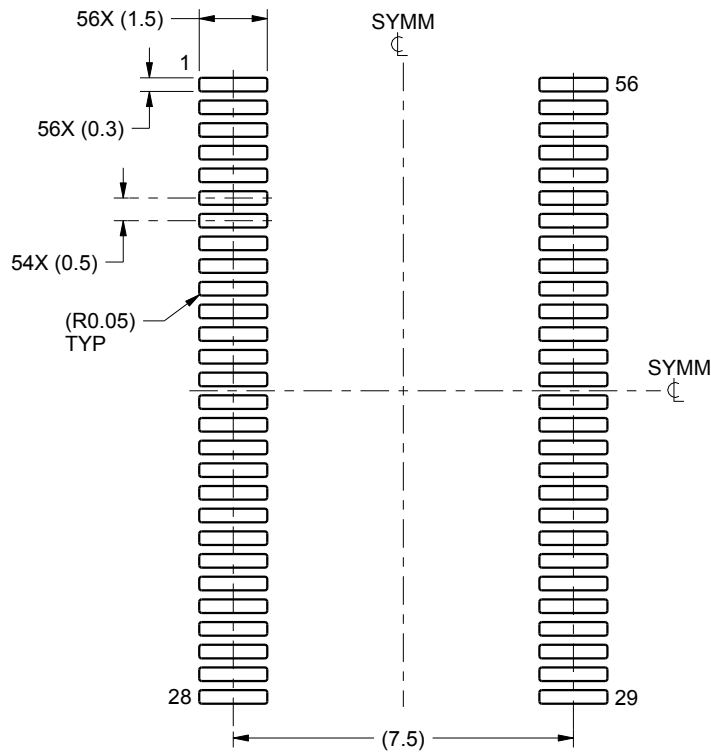

LAND PATTERN EXAMPLE
SCALE:6X

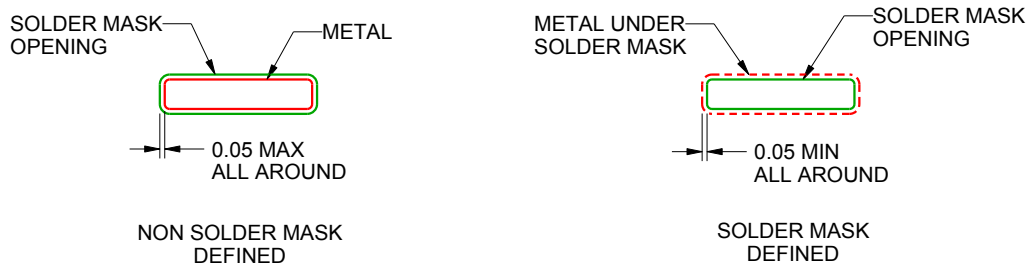

SOLDER MASK DETAILS

4222167/A 07/2015

NOTES: (continued)

- 5. Publication IPC-7351 may have alternate designs.
- 6. Solder mask tolerances between and around signal pads can vary based on board fabrication site.

EXAMPLE STENCIL DESIGN

DGG0056A

TSSOP - 1.2 mm max height

SMALL OUTLINE PACKAGE



SOLDER PASTE EXAMPLE
BASED ON 0.125 mm THICK STENCIL
SCALE:6X

4222167/A 07/2015

NOTES: (continued)

7. Laser cutting apertures with trapezoidal walls and rounded corners may offer better paste release. IPC-7525 may have alternate design recommendations.
8. Board assembly site may have different recommendations for stencil design.

IMPORTANT NOTICE

Texas Instruments Incorporated and its subsidiaries (TI) reserve the right to make corrections, enhancements, improvements and other changes to its semiconductor products and services per JESD46, latest issue, and to discontinue any product or service per JESD48, latest issue. Buyers should obtain the latest relevant information before placing orders and should verify that such information is current and complete. All semiconductor products (also referred to herein as "components") are sold subject to TI's terms and conditions of sale supplied at the time of order acknowledgment.

TI warrants performance of its components to the specifications applicable at the time of sale, in accordance with the warranty in TI's terms and conditions of sale of semiconductor products. Testing and other quality control techniques are used to the extent TI deems necessary to support this warranty. Except where mandated by applicable law, testing of all parameters of each component is not necessarily performed.

TI assumes no liability for applications assistance or the design of Buyers' products. Buyers are responsible for their products and applications using TI components. To minimize the risks associated with Buyers' products and applications, Buyers should provide adequate design and operating safeguards.

TI does not warrant or represent that any license, either express or implied, is granted under any patent right, copyright, mask work right, or other intellectual property right relating to any combination, machine, or process in which TI components or services are used. Information published by TI regarding third-party products or services does not constitute a license to use such products or services or a warranty or endorsement thereof. Use of such information may require a license from a third party under the patents or other intellectual property of the third party, or a license from TI under the patents or other intellectual property of TI.

Reproduction of significant portions of TI information in TI data books or data sheets is permissible only if reproduction is without alteration and is accompanied by all associated warranties, conditions, limitations, and notices. TI is not responsible or liable for such altered documentation. Information of third parties may be subject to additional restrictions.

Resale of TI components or services with statements different from or beyond the parameters stated by TI for that component or service voids all express and any implied warranties for the associated TI component or service and is an unfair and deceptive business practice. TI is not responsible or liable for any such statements.

Buyer acknowledges and agrees that it is solely responsible for compliance with all legal, regulatory and safety-related requirements concerning its products, and any use of TI components in its applications, notwithstanding any applications-related information or support that may be provided by TI. Buyer represents and agrees that it has all the necessary expertise to create and implement safeguards which anticipate dangerous consequences of failures, monitor failures and their consequences, lessen the likelihood of failures that might cause harm and take appropriate remedial actions. Buyer will fully indemnify TI and its representatives against any damages arising out of the use of any TI components in safety-critical applications.

In some cases, TI components may be promoted specifically to facilitate safety-related applications. With such components, TI's goal is to help enable customers to design and create their own end-product solutions that meet applicable functional safety standards and requirements. Nonetheless, such components are subject to these terms.

No TI components are authorized for use in FDA Class III (or similar life-critical medical equipment) unless authorized officers of the parties have executed a special agreement specifically governing such use.

Only those TI components which TI has specifically designated as military grade or "enhanced plastic" are designed and intended for use in military/aerospace applications or environments. Buyer acknowledges and agrees that any military or aerospace use of TI components which have **not** been so designated is solely at the Buyer's risk, and that Buyer is solely responsible for compliance with all legal and regulatory requirements in connection with such use.

TI has specifically designated certain components as meeting ISO/TS16949 requirements, mainly for automotive use. In any case of use of non-designated products, TI will not be responsible for any failure to meet ISO/TS16949.

Products

Audio	www.ti.com/audio
Amplifiers	amplifier.ti.com
Data Converters	dataconverter.ti.com
DLP® Products	www.dlp.com
DSP	dsp.ti.com
Clocks and Timers	www.ti.com/clocks
Interface	interface.ti.com
Logic	logic.ti.com
Power Mgmt	power.ti.com
Microcontrollers	microcontroller.ti.com
RFID	www.ti-rfid.com
OMAP Applications Processors	www.ti.com/omap
Wireless Connectivity	www.ti.com/wirelessconnectivity

Applications

Automotive and Transportation	www.ti.com/automotive
Communications and Telecom	www.ti.com/communications
Computers and Peripherals	www.ti.com/computers
Consumer Electronics	www.ti.com/consumer-apps
Energy and Lighting	www.ti.com/energy
Industrial	www.ti.com/industrial
Medical	www.ti.com/medical
Security	www.ti.com/security
Space, Avionics and Defense	www.ti.com/space-avionics-defense
Video and Imaging	www.ti.com/video

TI E2E Community

e2e.ti.com