



# 3.3V Spread-Spectrum EconOscillator

DS1086L

## General Description

The DS1086L EconOscillator™ is a 3.3V programmable clock generator that produces a spread-spectrum (dithered) square-wave output of frequencies from 130kHz to 66.6MHz. The selectable dithered output reduces radiated-emission peaks by dithering the frequency 0.5%, 1%, 2%, 4%, or 8% below the programmed frequency. The DS1086L has a power-down mode and an output-enable control for power-sensitive applications. All the device settings are stored in non-volatile (NV) EEPROM memory allowing it to operate in stand-alone applications.

## Applications

- Printers
- Copiers
- PCs
- Computer Peripherals
- Cell Phones
- Cable Modems

## Features

- ◆ User-Programmable Square-Wave Generator
- ◆ Frequencies Programmable from 130kHz to 66.6MHz
- ◆ 0.5%, 1%, 2%, 4%, or 8% Selectable Dithered Output
- ◆ Adjustable Dither Rate
- ◆ Glitchless Output-Enable Control
- ◆ 2-Wire Serial Interface
- ◆ Nonvolatile Settings
- ◆ 2.7V to 3.6V Supply
- ◆ No External Timing Components Required
- ◆ Power-Down Mode
- ◆ 5kHz Master Frequency Step Size
- ◆ EMI Reduction
- ◆ Industrial Temperature Range: -40°C to +85°C

## Ordering Information

| PART      | TEMP RANGE     | PIN-PACKAGE       |
|-----------|----------------|-------------------|
| DS1086LU  | -40°C to +85°C | 8 μSOP (118 mils) |
| DS1086LU+ | -40°C to +85°C | 8 μSOP (118 mils) |

**Note:** Contact the factory for custom settings.

+Denotes a lead(Pb)-free/RoHS-compliant package.

## Typical Operating Circuit

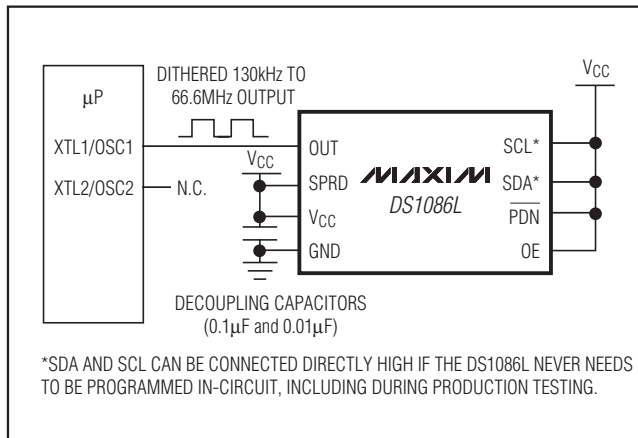

## Pin Configuration

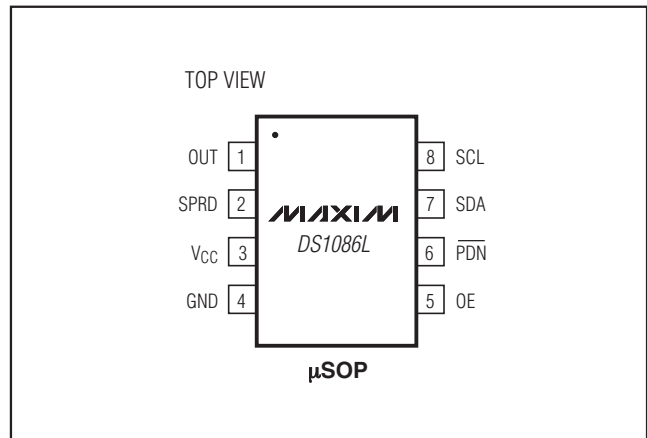

EconOscillator is a trademark of Maxim Integrated Products, Inc.



# 3.3V Spread-Spectrum EconOscillator

## ABSOLUTE MAXIMUM RATINGS

|   |                                  |   |                 |
|---|----------------------------------|---|-----------------|
| Voltage Range on V <sub>CC</sub> Relative to Ground .....   | -0.5V to +6.0V                   | Programming Temperature Range .....                   | 0°C to +70°C    |
| Voltage Range on SPRD, P <sub>DN</sub> , OE, SDA, and SCL<br>Relative to Ground* .....            | -0.5 to (V <sub>CC</sub> + 0.5V) | Junction Temperature .....                            | +150°C          |
| Continuous Power Dissipation (T <sub>A</sub> = +70°C)<br>μSOP (derate 4.5mW/°C above +70°C) ..... | 362mW                            | Storage Temperature Range .....                       | -55°C to +150°C |
| Operating Temperature Range .....   | -40°C to +85°C                   | Soldering Temperature (reflow)<br>Lead(Pb)-free ..... | +260°C          |
|   |                                  | Containing lead(Pb) .....                             | +240°C          |

\*This voltage must not exceed 6.0V.

Stresses beyond those listed under "Absolute Maximum Ratings" may cause permanent damage to the device. These are stress ratings only, and functional operation of the device at these or any other conditions beyond those indicated in the operational sections of the specifications is not implied. Exposure to absolute maximum rating conditions for extended periods may affect device reliability.

## RECOMMENDED DC OPERATING CONDITIONS

(V<sub>CC</sub> = 2.7V to 3.6V, T<sub>A</sub> = -40°C to +85°C.)

| PARAMETER  | SYMBOL          | CONDITIONS | MIN                      | TYP | MAX                      | UNITS |
|--|-----------------|------------|--------------------------|-----|--------------------------|-------|
| Supply Voltage   | V <sub>CC</sub> | (Note 1)   | 2.7                      | 3.3 | 3.6                      | V     |
| High-Level Input Voltage<br>(SDA, SCL, SPRD, P <sub>DN</sub> , OE) | V <sub>IH</sub> |            | 0.7 x<br>V <sub>CC</sub> |     | V <sub>CC</sub> +<br>0.3 | V     |
| Low-Level Input Voltage<br>(SDA, SCL SPRD, P <sub>DN</sub> , OE)   | V <sub>IL</sub> |            | -0.3                     |     | 0.3 x<br>V <sub>CC</sub> | V     |

## DC ELECTRICAL CHARACTERISTICS

(V<sub>CC</sub> = 2.7V to 3.6V, T<sub>A</sub> = -40°C to +85°C.)

| PARAMETER                       | SYMBOL           | CONDITIONS  | MIN | TYP | MAX | UNITS |
|---------------------------------|------------------|---|-----|-----|-----|-------|
| High-Level Output Voltage (OUT) | V <sub>OH</sub>  | I <sub>OH</sub> = -4mA, V <sub>CC</sub> = min       | 2.4 |     |     | V     |
| Low-Level Output Voltage (OUT)  | V <sub>OL</sub>  | I <sub>OL</sub> = 4mA                               | 0   |     | 0.4 | V     |
| Low-Level Output Voltage (SDA)  | V <sub>OL1</sub> | 3mA sink current                                    | 0   |     | 0.4 | V     |
|                                 | V <sub>OL2</sub> | 6mA sink current                                    | 0   |     | 0.6 |       |
| High-Level Input Current        | I <sub>IH</sub>  | V <sub>CC</sub> = 3.6V                              |     |     | 1   | μA    |
| Low-Level Input Current         | I <sub>IL</sub>  | V <sub>IL</sub> = 0V                                | -1  |     |     | μA    |
| Supply Current (Active)         | I <sub>CC</sub>  | C <sub>L</sub> = 15pF (output at default frequency) |     |     | 10  | mA    |
| Standby Current (Power-Down)    | I <sub>CCQ</sub> | Power-down mode                                     |     |     | 10  | μA    |

# 3.3V Spread-Spectrum EconOscillator

DS1086L

## MASTER OSCILLATOR CHARACTERISTICS

(V<sub>CC</sub> = 2.7V to 3.6V, T<sub>A</sub> = -40°C to +85°C.)

| PARAMETER                             | SYMBOL                   | CONDITIONS  | MIN                                | TYP                                    | MAX   | UNITS   |
|---------------------------------------|--------------------------|---|------------------------------------|--|-------|---------|
| Master Oscillator Frequency           | f <sub>OSC</sub>         | (Note 2)  | 33.3                               |  | 66.6  | MHz     |
| Default Master Oscillator Frequency   | f <sub>0</sub>           | Factory-programmed default  |                                    | 48.65                                  |       | MHz     |
| Master Oscillator Frequency Tolerance | $\frac{\Delta f_0}{f_0}$ | V <sub>CC</sub> = 3.3V,<br>T <sub>A</sub> = +25°C<br>(Notes 3,17) | Default frequency(f <sub>0</sub> ) | -0.5                                   | +0.5  | %       |
|                                       |                          |   | DAC step size                      | -0.5                                   | +0.5  |         |
| Voltage Frequency Variation           | $\frac{\Delta f_V}{f_0}$ | Over voltage range,<br>T <sub>A</sub> = +25°C (Note 4)            | Default frequency                  | -0.75                                  | +0.75 | %       |
|                                       |                          |   | DAC step size                      | -0.75                                  | +0.75 |         |
| Temperature Frequency Variation       | $\frac{\Delta f_T}{f_0}$ | Over temperature range, V <sub>CC</sub> = 3.3V<br>(Note 5)        | Default frequency                  | -2.0                                   | +0.75 | %       |
|                                       |                          |   | 66.6MHz                            | -2.0                                   | +0.75 |         |
|                                       |                          |   | 33.3MHz                            | -2.5                                   | +0.75 |         |
| Dither Frequency Range (Note 6)       | $\frac{\Delta f}{f_0}$   | Prescaler bits JS2, JS1, JS0 = 000                                |                                    | 0.5                                    |       | %       |
|                                       |                          | Prescaler bits JS2, JS1, JS0 = 001                                |                                    | 1                                      |       |         |
|                                       |                          | Prescaler bits JS2, JS1, JS0 = 010                                |                                    | 2                                      |       |         |
|                                       |                          | Prescaler bits JS2, JS1, JS0 = 100                                |                                    | 4                                      |       |         |
|                                       |                          | Prescaler bits JS2, JS1, JS0 = 111                                |                                    | 8                                      |       |         |
| Integral Nonlinearity of Frequency    | INL                      | Entire range (Note 7)   | -0.6                               |  | +0.3  | %       |
| DAC Step Size                         |                          | Δ between two consecutive DAC values<br>(Note 8)                  |                                    | 5                                      |       | kHz     |
| DAC Span                              |                          | Frequency range for one offset setting<br>(Table 2)               |                                    | 5.12                                   |       | MHz     |
| DAC Default                           |                          | Factory default register setting                                  |                                    | 500                                    |       | decimal |
| Offset Step Size                      |                          | Δ between two consecutive offset values<br>(Table 2)              |                                    | 2.56                                   |       | MHz     |
| Offset Default                        | OS                       | Factory default OFFSET register setting<br>(5 LSBs) (Table 2)     |                                    | RANGE<br>(5 LSBs of<br>RANGE register) |       | hex     |
| Dither Rate                           |                          | Prescaler bits JS4, JS3 = 00                                      |                                    | f <sub>0</sub> /8192                   |       | Hz      |
|                                       |                          | Prescaler bits JS4, JS3 = 01                                      |                                    | f <sub>0</sub> /4096                   |       |         |
|                                       |                          | Prescaler bits JS4, JS3 = 10                                      |                                    | f <sub>0</sub> /2048                   |       |         |

## 3.3V Spread-Spectrum EconOscillator

### AC ELECTRICAL CHARACTERISTICS

( $V_{CC} = 2.7V$  to  $3.6V$ ,  $T_A = -40^{\circ}C$  to  $+85^{\circ}C$ .)

| PARAMETER                                   | SYMBOL               | CONDITIONS        | MIN | TYP | MAX | UNITS   |
|---|----------------------|-------------------|-----|-----|-----|---------|
| Frequency Stable After Prescaler Change     |                      |                   |     |     | 1   | period  |
| Frequency Stable After DAC or Offset Change | $t_{DACstab}$        | (Note 9)          |     | 0.1 | 1   | ms      |
| Power-Up Time                               | $t_{por} + t_{stab}$ | (Note 10)         |     | 0.1 | 0.5 | ms      |
| Enable of OUT After Exiting Power-Down Mode | $t_{stab}$           | (Note 18)         |     |     | 200 | $\mu s$ |
| OUT High-Z After Entering Power-Down Mode   | $t_{pdn}$            |                   |     |     | 100 | $\mu s$ |
| Load Capacitance                            | $C_L$                | (Note 11)         |     | 15  | 50  | pF      |
| Output Duty Cycle (OUT)                     |                      | Default frequency | 45  |     | 55  | %       |
| Rise and Fall Time (OE, $\overline{PDN}$ )  |                      |                   |     |     | 1   | $\mu s$ |

### AC ELECTRICAL CHARACTERISTICS—2-WIRE INTERFACE

( $V_{CC} = 2.7V$  to  $3.6V$ ,  $T_A = -40^{\circ}C$  to  $+85^{\circ}C$ .)

| PARAMETER  | SYMBOL       | CONDITIONS    | MIN                | TYP           | MAX  | UNITS   |
|--|--------------|---------------|--------------------|---------------|------|---------|
| SCL Clock Frequency                              | $f_{SCL}$    | Fast mode     |                    |               | 400  | kHz     |
|  |              | Standard mode | (Note 12)          |               | 100  |         |
| Bus Free Time Between a STOP and START Condition | $t_{BUF}$    | Fast mode     |                    | 1.3           |      | $\mu s$ |
|  |              | Standard mode | (Note 12)          | 4.7           |      |         |
| Hold Time (Repeated) START Condition             | $t_{HD:STA}$ | Fast mode     |                    | 0.6           |      | $\mu s$ |
|  |              | Standard mode | (Notes 12, 13)     | 4.0           |      |         |
| LOW Period of SCL                                | $t_{LOW}$    | Fast mode     |                    | 1.3           |      | $\mu s$ |
|  |              | Standard mode | (Note 12)          | 4.7           |      |         |
| HIGH Period of SCL                               | $t_{HIGH}$   | Fast mode     |                    | 0.6           |      | $\mu s$ |
|  |              | Standard mode | (Note 12)          | 4.0           |      |         |
| Setup Time for a Repeated START                  | $t_{SU:STA}$ | Fast mode     |                    | 0.6           |      | $\mu s$ |
|  |              | Standard mode | (Note 12)          | 4.7           |      |         |
| Data Hold Time                                   | $t_{HD:DAT}$ | Fast mode     |                    | 0             | 0.9  | $\mu s$ |
|  |              | Standard mode | (Notes 12, 14, 15) |               |      |         |
| Data Setup Time                                  | $t_{SU:DAT}$ | Fast mode     |                    | 100           |      | ns      |
|  |              | Standard mode | (Note 12)          | 250           |      |         |
| Rise Time of Both SDA and SCL Signals            | $t_R$        | Fast mode     |                    | $20 + 0.1C_B$ | 300  | ns      |
|  |              | Standard mode | (Note 16)          | $20 + 0.1C_B$ | 1000 |         |
| Fall Time of Both SDA and SCL Signals            | $t_F$        | Fast mode     |                    | $20 + 0.1C_B$ | 300  | ns      |
|  |              | Standard mode | (Note 16)          | $20 + 0.1C_B$ | 1000 |         |

# 3.3V Spread-Spectrum EconOscillator

DS1086L

## AC ELECTRICAL CHARACTERISTICS—2-WIRE INTERFACE (continued)

( $V_{CC} = 2.7V$  to  $3.6V$ ,  $T_A = -40^{\circ}C$  to  $+85^{\circ}C$ .)

| PARAMETER                         | SYMBOL              | CONDITIONS    | MIN | TYP | MAX | UNITS |
|-----------------------------------|---------------------|---------------|-----|-----|-----|-------|
| Setup Time for STOP               | t <sub>SU:STO</sub> | Fast mode     | 0.6 |     |     | μs    |
|                                   |                     | Standard mode | 4.0 |     |     |       |
| Capacitive Load for Each Bus Line | C <sub>B</sub>      | (Note 16)     |     |     | 400 | pF    |
| EEPROM Write Cycle Time           | t <sub>WR</sub>     |               |     |     | 10  | ms    |
| Input Capacitance                 | C <sub>I</sub>      |               |     | 5   |     | pF    |

## NONVOLATILE MEMORY CHARACTERISTICS

( $V_{CC} = 2.7V$  to  $3.6V$ )

| PARAMETER     | SYMBOL | CONDITIONS | MIN    | TYP | MAX | UNITS |
|---------------|--------|------------|--------|-----|-----|-------|
| EEPROM Writes |        | +70°C      | 10,000 |     |     |       |

- Note 1:** All voltages are referenced to ground.
- Note 2:** DAC and OFFSET register settings must be configured to maintain the master oscillator frequency within this range. Correct operation of the device is not guaranteed if these limits are exceeded.
- Note 3:** This is the absolute accuracy of the master oscillator frequency at the default settings.
- Note 4:** This is the change that is observed in master oscillator frequency with changes in voltage from nominal voltage at  $T_A = +25^{\circ}C$ .
- Note 5:** This is the percentage frequency change from the  $+25^{\circ}C$  frequency due to temperature at  $V_{CC} = 3.3V$ . The maximum temperature change varies with the master oscillator frequency setting. The minimum occurs at the default master oscillator frequency ( $f_{default}$ ). The maximum occurs at the extremes of the master oscillator frequency range (33.3MHz or 66.6MHz).
- Note 6:** The dither deviation of the master oscillator frequency is unidirectional and lower than the undithered frequency.
- Note 7:** The integral nonlinearity of the frequency is a measure of the deviation from a straight line drawn between the two end-points ( $f_{osc(MIN)}$  to  $f_{osc(MAX)}$ ) of the range. The error is in percentage of the span.
- Note 8:** This is true when the prescaler = 1.
- Note 9:** Frequency settles faster for small changes in value. During a change, the frequency transitions smoothly from the original value to the new value.
- Note 10:** This indicates the time elapsed between power-up and the output becoming active. An on-chip delay is intentionally introduced to allow the oscillator to stabilize.  $t_{stab}$  is equivalent to approximately 512 master clock cycles and therefore depends on the programmed clock frequency.
- Note 11:** Output voltage swings can be impaired at high frequencies combined with high output loading.
- Note 12:** A fast-mode device can be used in a standard-mode system, but the requirement  $t_{SU:DAT} > 250ns$  must then be met. This is automatically the case if the device does not stretch the LOW period of the SCL signal. If such a device does stretch the LOW period of the SCL signal, it must output the next data bit to the SDA line at least  $t_{R MAX} + t_{SU:DAT} = 1000ns + 250ns = 1250ns$  before the SCL line is released.
- Note 13:** After this period, the first clock pulse is generated.
- Note 14:** A device must internally provide a hold time of at least 300ns for the SDA signal (referred to as the  $V_{IH MIN}$  of the SCL signal) to bridge the undefined region of the falling edge of SCL.
- Note 15:** The maximum  $t_{HD:DAT}$  need only be met if the device does not stretch the LOW period ( $t_{LOW}$ ) of the SCL signal.
- Note 16:** C<sub>B</sub>—total capacitance of one bus line, timing referenced to  $0.9 \times V_{CC}$  and  $0.1 \times V_{CC}$ .
- Note 17:** Typical frequency shift due to aging is  $\pm 0.5\%$ . Aging stressing includes Level 1 moisture reflow preconditioning (24hr  $+125^{\circ}C$  bake, 168hr  $85^{\circ}C/85\%RH$  moisture soak, and three solder reflow passes  $+240 \pm 0/-5^{\circ}C$  peak) followed by 1000hr max  $V_{CC}$  biased  $125^{\circ}C$  HTOL, 1000 temperature cycles at  $-55^{\circ}C$  to  $+125^{\circ}C$ , 96hr  $130^{\circ}C/85\%RH/3.6V$  HAST and 168hr  $121^{\circ}C/2$  ATM Steam/Unbiased Autoclave.
- Note 18:**  $t_{stab}$  is the time required after exiting power-down to the beginning of output oscillations. In addition, a delay of  $t_{DACstab}$  is required before the frequency will be within its specified tolerance.

# 3.3V Spread-Spectrum EconOscillator

## Typical Operating Characteristics

( $V_{CC} = 3.3V$ ,  $T_A = 25^\circ C$ , unless otherwise noted.)

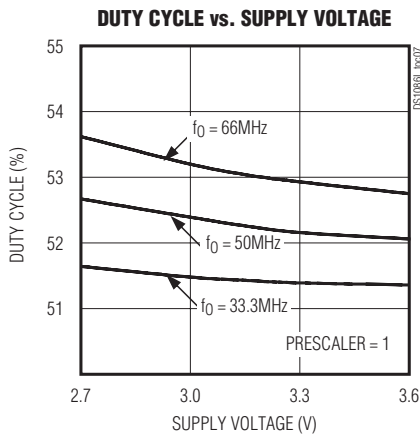
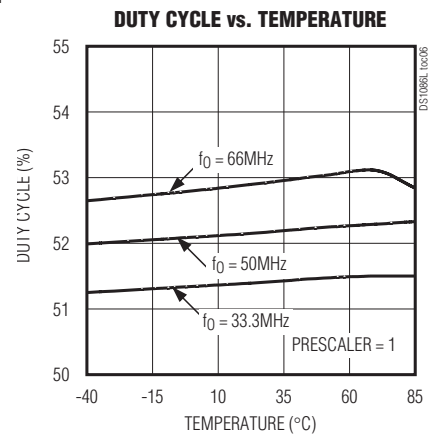
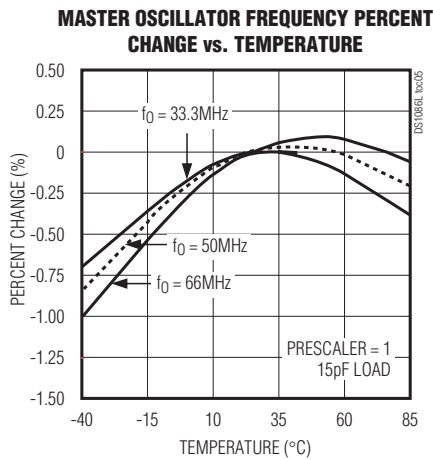
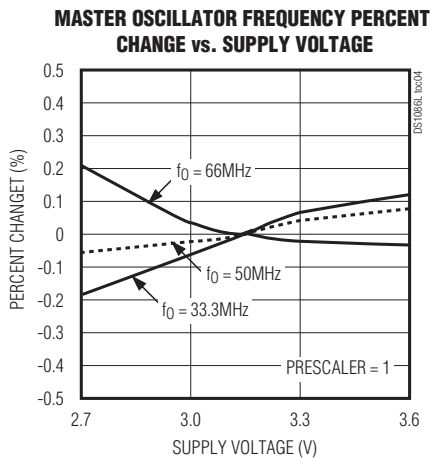
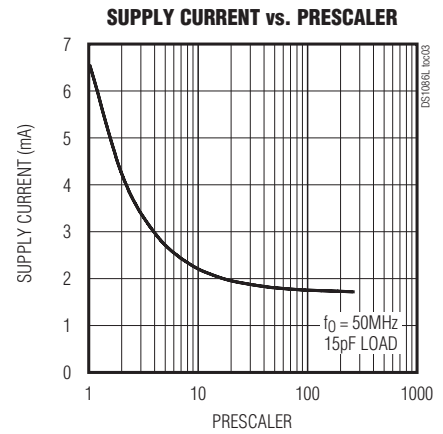
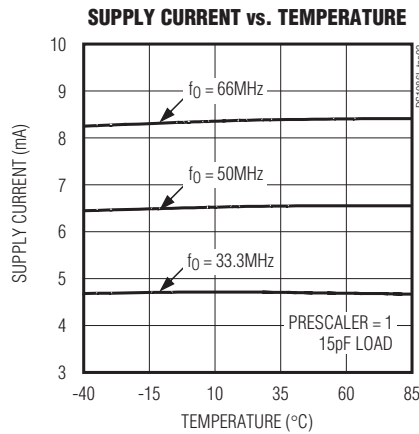
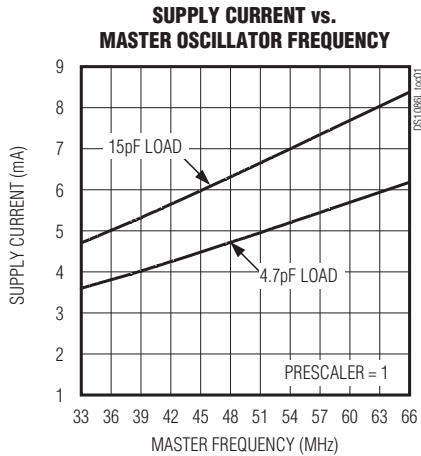

# 3.3V Spread-Spectrum EconOscillator

DS1086L

## Typical Operating Characteristics (continued)

( $V_{CC} = 3.3V$ ,  $T_A = 25^\circ C$ , unless otherwise noted.)

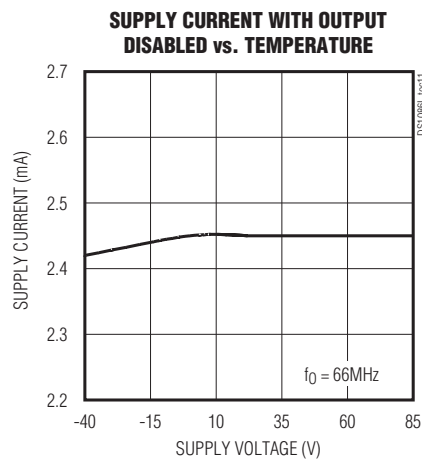
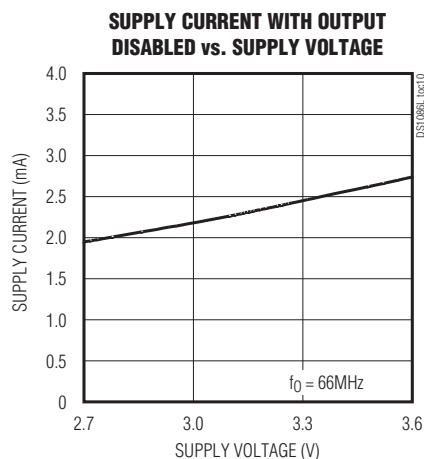
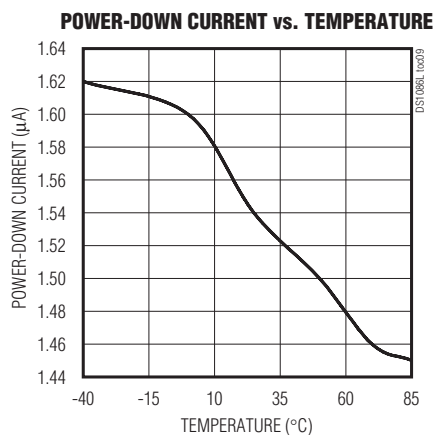
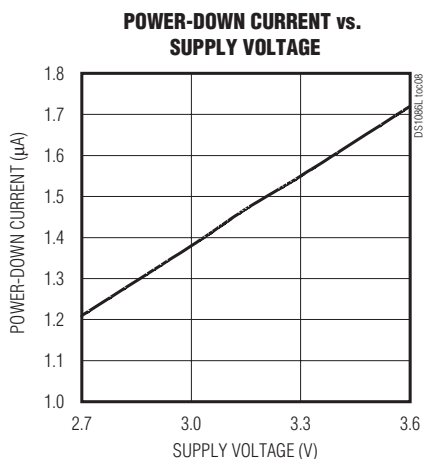

# 3.3V Spread-Spectrum EconOscillator

## Pin Description

| PIN | NAME | FUNCTION  |
|-----|------|---|
| 1   | OUT  | Oscillator Output. The output frequency is determined by the OFFSET, DAC, and prescaler registers.  |
| 2   | SPRD | Dither Enable. When the pin is high, the dither is enabled. When the pin is low, the dither is disabled.  |
| 3   | VCC  | Power Supply  |
| 4   | GND  | Ground  |
| 5   | OE   | Output Enable. When the pin is high, the output buffer is enabled. When the pin is low, the output is disabled but the master oscillator is still on.                           |
| 6   | PDN  | Power-Down. When the pin is high, the master oscillator is enabled. When the pin is low, the master oscillator is disabled (power-down mode).                                   |
| 7   | SDA  | 2-Wire Serial Data. This pin is for serial data transfer to and from the device. The pin is open drain and can be wire-ORed with other open-drain or open-collector interfaces. |
| 8   | SCL  | 2-Wire Serial Clock. This pin is used to clock data into the device on rising edges and clock data out on falling edges.  |

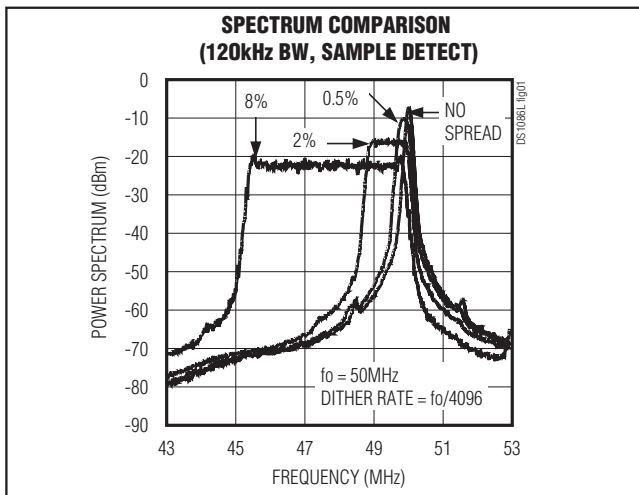

Figure 1. Clock Spectrum Dither Comparison

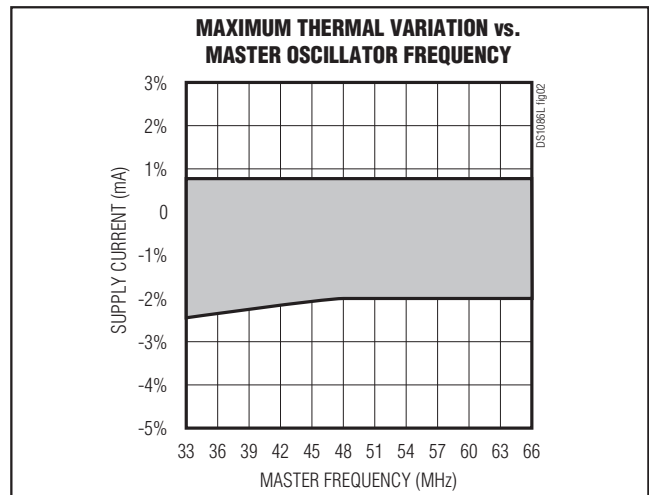
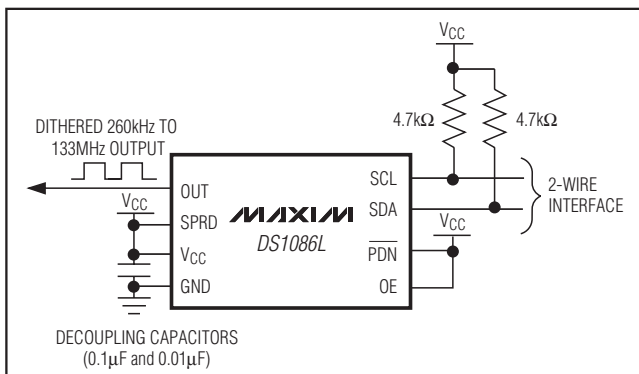
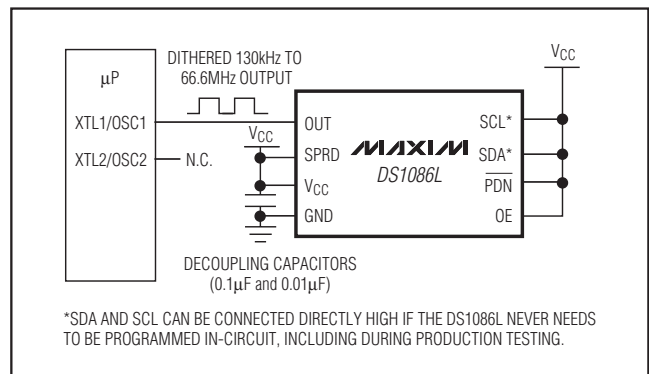

Figure 2. Temperature Variation Over Frequency

### Processor-Controlled Mode



### Stand-Alone Mode





## 3.3V Spread-Spectrum EconOscillator

DS1086L

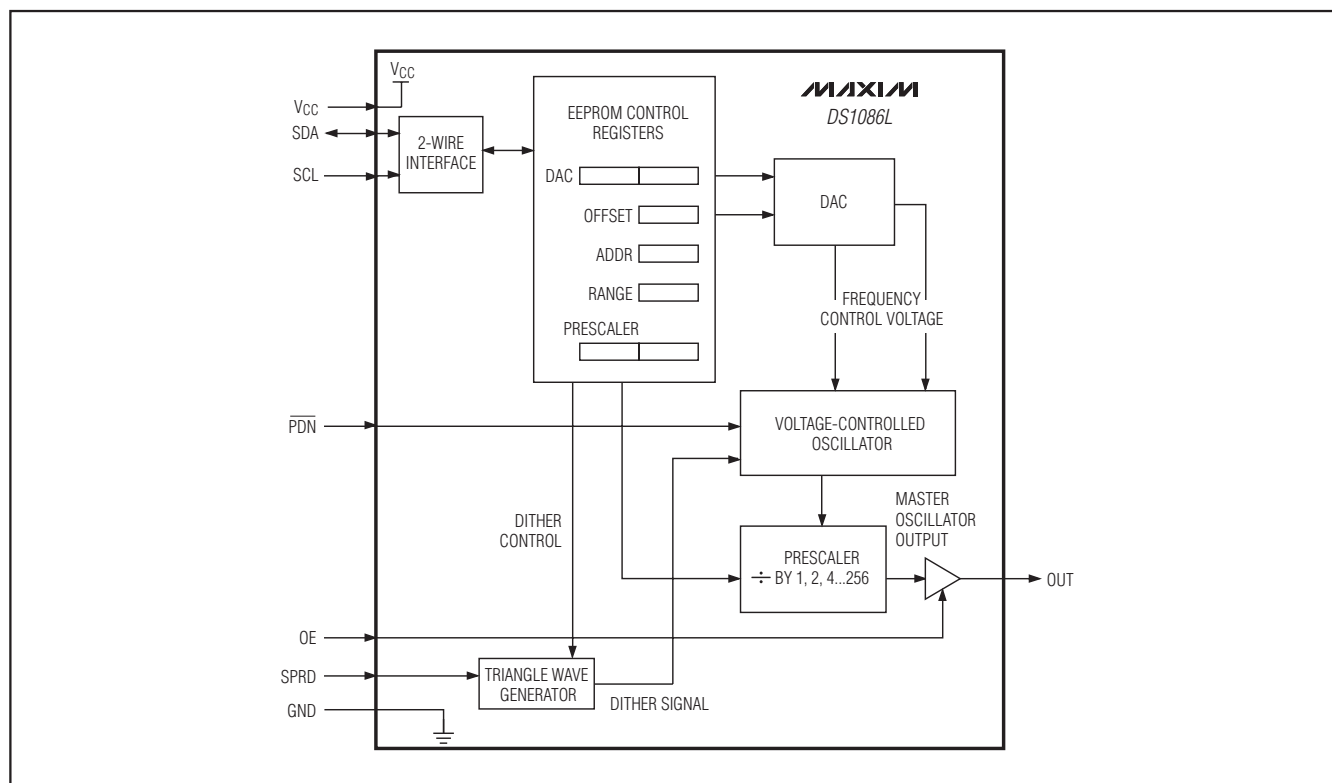

Figure 3. Block Diagram

### Detailed Description

A block diagram of the DS1086L is shown in Figure 3. The internal master oscillator generates a square wave with a 33.3MHz to 66.6MHz frequency range. The frequency of the master oscillator can be programmed with the DAC register over a two-to-one range in 5kHz steps. The master oscillator range is larger than the range possible with the DAC step size, so the OFFSET register is used to select a smaller range of frequencies over which the DAC spans. The prescaler can then be set to divide the master oscillator frequency by  $2^x$  (where  $x$  equals 0 to 8) before routing the signal to the output (OUT) pin.

A programmable triangle-wave generator injects an offset element into the master oscillator to dither its output 0.5%, 1%, 2%, 4%, or 8%. The dither magnitude is controlled by the JS2, JS1, and JS0 bits in the PRESCALER word and enabled with the SPRD pin. Furthermore, the dither rate is controlled by the JS4 and JS3 bits in the PRESCALER word and determines the frequency of the dither. The maximum spectral attenuation occurs when the prescaler is set to 1 and is reduced by 2.7dB for every factor of 2 that is used in the prescaler. This hap-

pens because the prescaler's divider function tends to average the dither in creating the lower frequency. However, the most stringent spectral emission limits are imposed on the higher frequencies where the prescaler is set to a low divider ratio.

The external control input, OE, gates the clock output buffer. The PDN pin disables the master oscillator and turns off the clock output for power-sensitive applications\*. On power-up, the clock output is disabled until power is stable and the master oscillator has generated 512 clock cycles. Both controls feature a synchronous enable that ensures there are no output glitches when the output is enabled.

The control registers are programmed through a 2-wire interface and are used to determine the output frequency and settings. Once programmed into EEPROM, since the register settings are NV, the settings only need to be reprogrammed if it is desired to reconfigure the device.

\*The power-down command must persist for at least two output frequency cycles plus 10 $\mu$ s for deglitching purposes.

# 3.3V Spread-Spectrum EconOscillator

**Table 1. Register Summary**

| REGISTER  | ADDR | MSB            |                |                |                |                |                |                |                | BINARY |  |  | LSB       | FACTORY DEFAULT | ACCESS |
|-----------|------|----------------|----------------|----------------|----------------|----------------|----------------|----------------|----------------|--------|--|--|-----------|-----------------|--------|
| PRESCALER | 02h  | JS4            | JS3            | JS2            | JS1            | JS0            | LO/HiZ         | P3             | P2             |        |  |  | 01100000  | R/W             |        |
| PRESCALER | —    | P1             | P0             | X <sub>X</sub> | X <sub>X</sub> | X <sub>X</sub> | X <sub>X</sub> | X <sub>X</sub> | X <sub>X</sub> |        |  |  | 00XXXXX   | R/W             |        |
| DAC (MSB) | 08h  | b9             | b8             | b7             | b6             | b5             | b4             | b3             | b2             |        |  |  | 01111101b | R/W             |        |
| DAC (LSB) | —    | b1             | b0             | X <sub>0</sub> | X <sub>0</sub> | X <sub>0</sub> | X <sub>0</sub> | X <sub>0</sub> | X <sub>0</sub> |        |  |  | 00000000b | R/W             |        |
| OFFSET    | 0Eh  | X <sub>1</sub> | X <sub>1</sub> | X <sub>1</sub> | b4             | b3             | b2             | b1             | b0             |        |  |  | 111-----b | R/W             |        |
| ADDR      | 0Dh  | X <sub>1</sub> | X <sub>1</sub> | X <sub>1</sub> | X <sub>1</sub> | WC             | A2             | A1             | A0             |        |  |  | 11110000b | R/W             |        |
| RANGE     | 37h  | X <sub>X</sub> | X <sub>X</sub> | X <sub>X</sub> | b4             | b3             | b2             | b1             | b0             |        |  |  | xxx-----b | R               |        |
| WRITE EE  | 3Fh  | NO DATA        |                |                |                |                |                |                |                |        |  |  | —         | —               |        |

X<sub>0</sub> = Don't care, reads as zero.

X<sub>1</sub> = Don't care, reads as one.

X<sub>X</sub> = Don't care, reads indeterminate.

X = Don't care.

**Table 2. Offset Settings**

| OFFSET | FREQUENCY RANGE (MHz) |
|--------|-----------------------|
| OS - 6 | 61.44 to 71.67        |
| OS - 5 | 66.56 to 76.79        |
| OS - 4 | 71.68 to 81.91        |
| OS - 3 | 76.80 to 87.03        |
| OS - 2 | 81.92 to 92.15        |
| OS - 1 | 87.04 to 97.27        |
| OS*    | 92.16 to 102.39       |
| OS + 1 | 97.28 to 107.51       |
| OS + 2 | 102.40 to 112.63      |
| OS + 3 | 107.52 to 117.75      |
| OS + 4 | 112.64 to 122.87      |
| OS + 5 | 117.76 to 127.99      |
| OS + 6 | 122.88 to 133.11      |

\*Factory default setting. OS is the integer value of the five LSBs of the RANGE register.

The output frequency is determined by the following equation:

$$f_{\text{OUTPUT}} = \frac{f_{\text{(MIN FREQUENCY OF SELECTED OFFSET RANGE)}} + (\text{DAC VALUE} \times 5\text{kHz STEP SIZE})}{\text{PRESCALER}}$$

where: *min frequency of selected OFFSET range* is the lowest frequency (shown in Table 2 for the corresponding offset).

*DAC value* is the value of the DAC register (0 to 1023).

*Prescaler* is the value of 2<sup>x</sup> where x = 0 to 8.

See the *Example Frequency Calculations* section for a more in-depth look at using the registers.

## Register Definitions

The DS1086L registers are used to program the output frequency, dither percent, dither rate, and 2-wire address. Table 1 shows a summary of the registers and detailed descriptions follow below.

### PRESCALER (02h)

The PRESCALER word is a two-byte value containing control bits for the prescaler (P3 to P0), output control (Lo/HiZ), the jitter rate (JS4 to JS3), as well as control bits for the jitter percentage (JS2 to JS0). The PRESCALER word is read and written using two-byte reads and writes beginning at address 02h.

**JS4 to JS3: Jitter Rate.** This is the frequency of the triangle wave generator and the modulation frequency that the output is dithered. It can be programmed to the master oscillator frequency, f<sub>OSC</sub>, divided by either 8192, 4096, or 2048.

| JS4 | JS3 | JITTER RATE                      |
|-----|-----|----------------------------------|
| 0   | 0   | f <sub>OSC</sub> /8192           |
| 0   | 1   | f <sub>OSC</sub> /4096 (default) |
| 1   | 0   | f <sub>OSC</sub> /2048           |

## 3.3V Spread-Spectrum EconOscillator

**JS2 to JS0: Jitter Percentage.** These three bits select the amount of jitter in percent. The SPRD pin must be a logic high for the jitter to be enabled. Bit combinations not shown are reserved.

| JS2 | JS1 | JS0 | JITTER % |
|-----|-----|-----|----------|
| 0   | 0   | 0   | 0.5      |
| 0   | 0   | 1   | 1        |
| 0   | 1   | 0   | 2        |
| 1   | 0   | 0   | 4        |
| 1   | 1   | 1   | 8        |

**Lo/HiZ: Output Low or High-Z.** This bit determines the state of the output pin when the device is in power-down mode or when the output is disabled. If Lo/HiZ = 0, the output is HiZ when in power-down or disabled. If Lo/HiZ = 1, the output is held low when in power-down or disabled.

**P3 to P0: Prescaler Divider.** These bits divide the master oscillator frequency by  $2^x$ , where x is P3 to P0 and can be from 0 to 8. Any prescaler value entered greater than 8 decodes as 8.

### DAC (08h)

**B9 to B0: DAC Setting.** The DAC word sets the master oscillator frequency to a specific value within the current offset range. Each step of the DAC changes the master oscillator frequency by 5kHz. The DAC word is read and written using two-byte reads and writes beginning at address 08h.

### OFFSET (0Eh)

**B4 to B0: Offset.** This value selects the master oscillator frequency range that can be generated by varying the DAC word. Valid frequency ranges are shown in Table 2. Correct operation of the device is not guaranteed for values of OFFSET not shown in the table.

The default offset value (OS) is factory trimmed and can vary from device to device. Therefore, to change frequency range, OS must be read so the new offset value can be calculated relative to the default. For example, to generate a master oscillator frequency within the largest range (61.4MHz to 66.6MHz), Table 2 indicates that the OFFSET must be programmed to OS + 6. This is done by reading the RANGE register and adding 6 to the value of bits B4 to B0. The result is then written into bits B4 to B0 of the OFFSET register. Additional examples are provided in the *Example Frequency Calculations* section.

### RANGE (37h)

**B4 to B0: Range:** This read-only, factory programmed value is a copy of the factory default offset (OS). OS is

required to program new master oscillator frequencies shown in Table 2. The read-only backup is important because the offset register is EEPROM and is likely to be overwritten.

### ADDR (0Dh)

**WC: EEPROM Write Control Bit.** The WC bit enables/disables the automatic writing of registers to EEPROM. This prevents EEPROM wear out and eliminates the EEPROM write cycle time. If WC = 0 (default), register writes are automatically written to EEPROM. If WC = 1, register writes are stored in SRAM and only written into EEPROM when the user sends a WRITE EE command. If power is cycled to the device, then the last value stored in EEPROM is recalled. WC = 1 is ideal for applications that frequently modify the frequency/registers.

Regardless of the value of the WC bit, the value of the ADDR register is always written immediately to EEPROM.

**A2 to A0: Device Address Bits.** These bits determine the 2-wire slave address of the device. They allow up to eight devices to be attached to the same 2-wire bus and to be addressed individually.

### WRITE EE Command (3Fh)

This command can be used when WC = 1 (see the WC bit in ADDR register) to transfer all registers from SRAM into EEPROM. The time required to store the values is one EEPROM write cycle time. This command is not needed if WC = 0.

## 3.3V Spread-Spectrum EconOscillator

### Example Frequency Calculations

#### Example #1: Calculate the register values needed to generate a desired output frequency of 11.0592MHz.

Since the desired frequency is not within the valid master oscillator range of 33.3MHz to 66.6MHz, the prescaler must be used. Valid prescaler values are  $2^x$  where  $x$  equals 0 to 8 (and  $x$  is the value that is programmed into the P3 to P0 bits of the PRESCALER register). Equation 1 shows the relationship between the desired frequency, the master oscillator frequency, and the prescaler.

$$f_{\text{DESIRED}} = \frac{f_{\text{MASTER OSCILLATOR}}}{\text{prescaler}} \quad (1)$$

$$\frac{f_{\text{MASTER OSCILLATOR}}}{2^x}$$

By trial and error,  $x$  is incremented from 0 to 8 in Equation 2, finding values of  $x$  that yield master oscillator frequencies within the range of 33.3MHz to 66.6MHz.

Equation 2 shows that a prescaler of 4 ( $x = 2$ ) and a master oscillator frequency of 44.2368MHz generates our desired frequency. Writing 0080h to the PRESCALER register sets the PRESCALER to 4. Be aware that other settings also reside in the PRESCALER register.

$$f_{\text{MASTER OSCILLATOR}} = f_{\text{DESIRED}} \times \text{prescaler} = f_{\text{DESIRED}} \times 2^x$$

$$f_{\text{MASTER OSCILLATOR}} = 11.0592\text{MHz} \times 2^2 = 44.2368\text{MHz} \quad (2)$$

Once the target master oscillator frequency has been calculated, the value of offset can be determined. Using Table 2, 44.2368MHz falls within both OS - 1 and OS - 2. However, choosing OS - 1 would be a poor choice since 44.2368MHz is so close to OS - 1's minimum frequency. On the other hand, OS - 2 is ideal since 44.2368MHz is close to the center of OS - 2's frequency span. Before the OFFSET register can be programmed, the default value of offset (OS) must be read from the RANGE register (last five bits). In this example, 12h (18 decimal) was read from the RANGE register. OS - 2 for this case is 10h (16 decimal). This is the value that is written to the OFFSET register.

Finally, the two-byte DAC value needs to be determined. Since OS - 2 only sets the range of frequencies, the DAC selects one frequency within that range as shown in Equation 3.

$$f_{\text{MASTER OSCILLATOR}} = (\text{MIN FREQUENCY OF SELECTED OFFSET RANGE}) + (\text{DAC value} \times 5\text{kHz}) \quad (3)$$

Valid values of DAC are 0 to 1023 (decimal) and 5kHz is the step size. Equation 4 is derived from rearranging Equation 3 and solving for the DAC value.

$$\text{DAC VALUE} = \frac{(f_{\text{MASTER OSCILLATOR}} - \text{MIN FREQUENCY OF SELECTED OFFSET RANGE})}{5\text{kHz STEP SIZE}} \quad (4)$$

$$\text{DAC VALUE} = \frac{(44.2368\text{MHz} - 41.0\text{MHz})}{5\text{kHz STEP SIZE}}$$

$$= 647.36 \approx 647 \text{ (decimal)}$$

Since the two-byte DAC register is left justified, 647 is converted to hex (0287h) and bit-wise shifted left six places. The value to be programmed into the DAC register is A1C0h.

In summary, the DS1086L is programmed as follows:

PRESCALER = 0080h

OFFSET = OS - 2 or 10h (if range was read as 12h)

DAC = A1C0h

Notice that the DAC value was rounded. Unfortunately, this means that some error is introduced. To calculate how much error, a combination of Equation 1 and Equation 3 is used to calculate the expected output frequency. See Equation 5.

$$f_{\text{OUTPUT}} = \frac{(\text{MIN FREQUENCY OF SELECTED OFFSET RANGE}) + (\text{DAC VALUE} \times 5\text{kHz STEP SIZE})}{\text{prescaler}} \quad (5)$$

$$f_{\text{OUTPUT}} = \frac{(41.0\text{MHz}) + (647 \times 5\text{kHz})}{4}$$

$$\frac{44.235\text{MHz}}{4} = 11.05875\text{MHz}$$

## 3.3V Spread-Spectrum EconOscillator

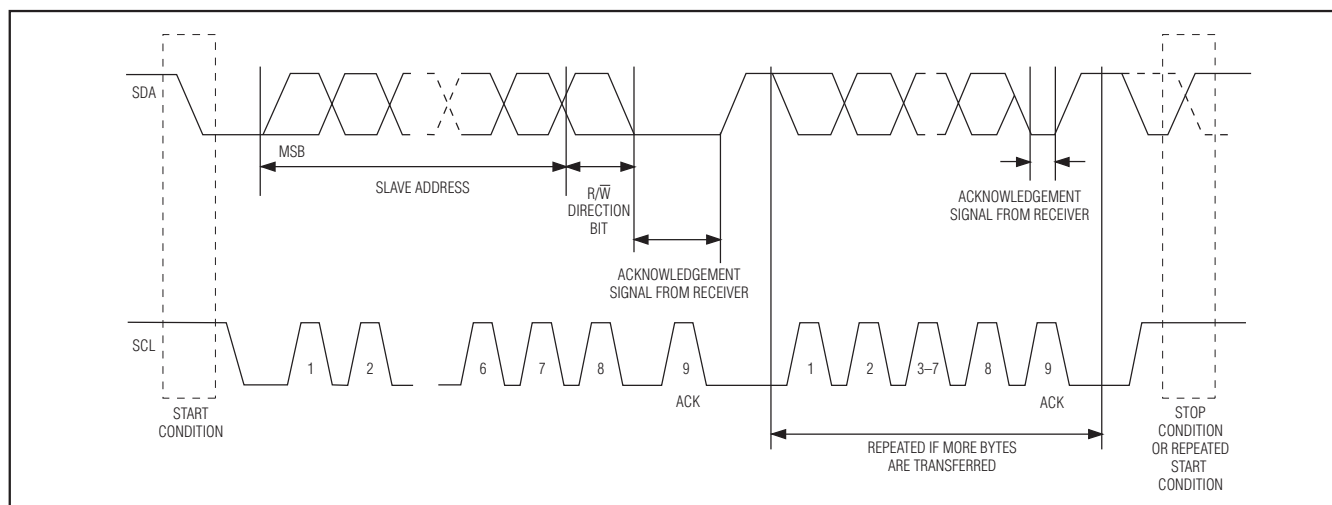

Figure 4. 2-Wire Data Transfer Protocol

The expected output frequency is not exactly equal to the desired frequency of 11.0592MHz. The difference is 450Hz. In terms of percentage, Equation 6 shows that the expected error is 0.004%. The expected error assumes typical values and does not include deviations from the typical as specified in the electrical tables.

$$\%ERROR_{EXPECTED} = \frac{f_{DESIRED} - f_{EXPECTED}}{f_{DESIRED}} \times 100 \quad (6)$$

$$\begin{aligned} \%ERROR_{EXPECTED} &= \frac{11.0592\text{MHz} - 11.05875\text{MHz}}{11.0592\text{MHz}} \times 100 \\ &= \frac{450\text{Hz}}{11.0592\text{MHz}} \times 100 = 0.004\% \end{aligned}$$

### Example #2: Calculate the register values needed to generate a desired output frequency of 50MHz.

Since the desired frequency is already within the valid master oscillator frequency range, the prescaler is set to divide by 1, and hence, PRESCALER = 0000h (currently ignoring the other setting).

$$f_{MASTER\ OSCILLATOR} = 50.0\text{MHz} \times 2^0 = 50.0\text{MHz} \quad (7)$$

Next, looking at Table 2, OS + 1 provides a range of frequencies centered around the desired frequency. To determine what value to write to the OFFSET register, the RANGE register must first be read. Assuming 12h was read in this example, 13h (OS + 1) is written to the OFFSET register.

Finally, the DAC value is calculated as shown in Equation 8.

$$DAC\ VALUE = \frac{(50.0\text{MHz} - 48.6\text{MHz})}{5\text{kHz}\ STEP\ SIZE} = 280.00\ (\text{decimal}) \quad (8)$$

The result is then converted to hex (0118h) and then left-shifted, resulting in 4600h to be programmed into the DAC register.

In summary, the DS1086L is programmed as follows:  
 PRESCALER = 0000h  
 OFFSET = OS + 1 or 13h (if RANGE was read as 12h)  
 DAC = 4600h

$$\begin{aligned} f_{OUTPUT} &= \frac{(48.6\text{MHz}) + (280 \times 5\text{kHz})}{2^0} = \\ &= \frac{50.0\text{MHz}}{1} = 50.0\text{MHz} \end{aligned} \quad (9)$$

Since the expected output frequency is equal to the desired frequency, the calculated error is 0%.

## 3.3V Spread-Spectrum EconOscillator

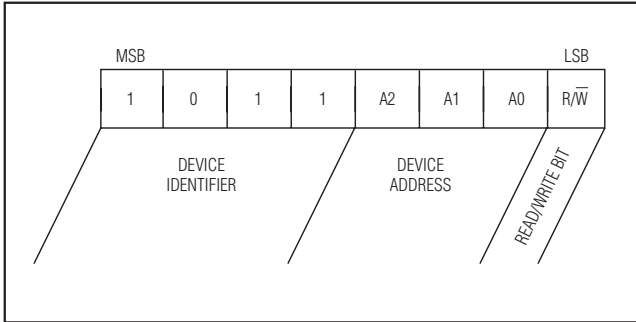

Figure 5. Slave Address

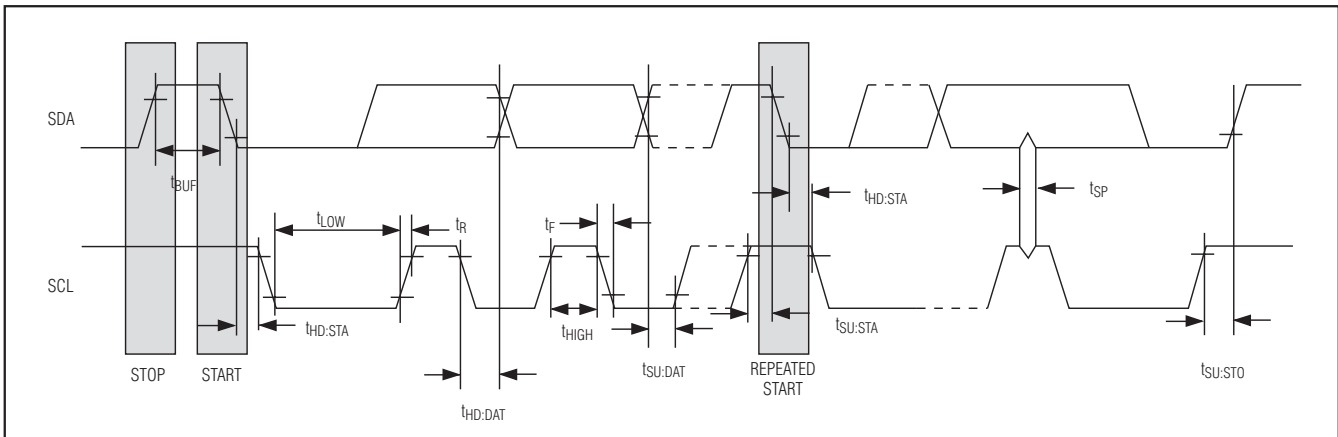

Figure 6. 2-Wire AC Characteristics

### 2-Wire Serial Port Operation

#### 2-Wire Serial Data Bus

The DS1086L communicates through a 2-wire serial interface. A device that sends data onto the bus is defined as a transmitter, and a device receiving data as a receiver. The device that controls the message is called a “master.” The devices that are controlled by the master are “slaves.” A master device that generates the serial clock (SCL), controls the bus access, and generates the START and STOP conditions must control the bus. The DS1086L operates as a slave on the 2-wire bus. Connections to the bus are made through the open-drain I/O lines SDA and SCL.

The following bus protocol has been defined (see Figures 4 and 6):

- Data transfer can be initiated only when the bus is not busy.
- During data transfer, the data line must remain stable whenever the clock line is HIGH. Changes

in the data line while the clock line is HIGH are interpreted as control signals.

Accordingly, the following bus conditions have been defined:

**Bus not busy:** Both data and clock lines remain HIGH.

**Start data transfer:** A change in the state of the data line, from HIGH to LOW, while the clock is HIGH, defines a START condition.

**Stop data transfer:** A change in the state of the data line, from LOW to HIGH, while the clock line is HIGH, defines the STOP condition.

**Data valid:** The state of the data line represents valid data when, after a START condition, the data line is stable for the duration of the HIGH period of the clock signal. The data on the line must be changed during the LOW period of the clock signal. There is one clock pulse per bit of data.

Each data transfer is initiated with a START condition and terminated with a STOP condition. The number of data bytes transferred between START and STOP con-

## 3.3V Spread-Spectrum EconOscillator

ditions is not limited, and is determined by the master device. The information is transferred byte-wise and each receiver acknowledges with a ninth bit.

Within the bus specifications a standard mode (100kHz clock rate) and a fast mode (400kHz clock rate) are defined. The DS1086L works in both modes.

**Acknowledge:** Each receiving device, when addressed, is obliged to generate an acknowledge after the byte has been received. The master device must generate an extra clock pulse that is associated with this acknowledge bit.

A device that acknowledges must pull down the SDA line during the acknowledge clock pulse in such a way that the SDA line is stable LOW during the HIGH period of the acknowledge-related clock pulse. Of course, setup and hold times must be taken into account. When the DS1086L EEPROM is being written to, it is not able to perform additional responses. In this case, the slave DS1086L sends a not acknowledge to any data transfer request made by the master. It resumes normal operation when the EEPROM operation is complete.

A master must signal an end of data to the slave by not generating an acknowledge bit on the last byte that has been clocked out of the slave. In this case, the slave must leave the data line HIGH to enable the master to generate the STOP condition.

Figures 4, 5, 6, and 7 detail how data transfer is accomplished on the 2-wire bus. Depending upon the state of the R/W bit, two types of data transfer are possible:

- 1) Data transfer from a master transmitter to a slave receiver. The first byte transmitted by the master is the slave address. Next follows a number of data bytes. The slave returns an acknowledge bit after each received byte.
- 2) Data transfer from a slave transmitter to a master receiver. The first byte (the slave address) is transmitted by the master. The slave then returns an acknowledge bit. Next follows a number of data bytes transmitted by the slave to the master. The master returns an acknowledge bit after all received bytes other than the last byte. At the end of the last received byte, a not acknowledge is returned.

The master device generates all the serial clock pulses and the START and STOP conditions. A transfer is ended with a STOP condition or with a repeated START condition. Since a repeated START condition is also the

beginning of the next serial transfer, the bus is not released.

The DS1086L can operate in the following two modes:

**Slave receiver mode:** Serial data and clock are received through SDA and SCL. After each byte is received, an acknowledge bit is transmitted. START and STOP conditions are recognized as the beginning and end of a serial transfer. Address recognition is performed by hardware after reception of the slave address and direction bit.

**Slave transmitter mode:** The first byte is received and handled as in the slave receiver mode. However, in this mode, the direction bit indicates that the transfer direction is reversed. Serial data is transmitted on SDA by the DS1086L while the serial clock is input on SCL. START and STOP conditions are recognized as the beginning and end of a serial transfer.

### Slave Address

Figure 5 shows the first byte sent to the device. It includes the device identifier, device address, and the R/W bit. The device address is determined by the ADDR register.

### Registers/Commands

See Table 1 for the complete list of registers/commands and Figure 7 for an example of using them.

## Applications Information

### Power-Supply Decoupling

To achieve the best results when using the DS1086L, decouple the power supply with 0.01 $\mu$ F and 0.1 $\mu$ F high-quality, ceramic, surface-mount capacitors. Surface-mount components minimize lead inductance, which improves performance, and ceramic capacitors tend to have adequate high-frequency response for decoupling applications. These capacitors should be placed as close to pins 3 and 4 as possible.

### Stand-Alone Mode

SCL and SDA cannot be left unconnected when they are not used. If the DS1086L never needs to be programmed in-circuit, including during production testing, SDA and SCL can be tied high. The SPRD pin must be tied either high or low.

# 3.3V Spread-Spectrum EconOscillator

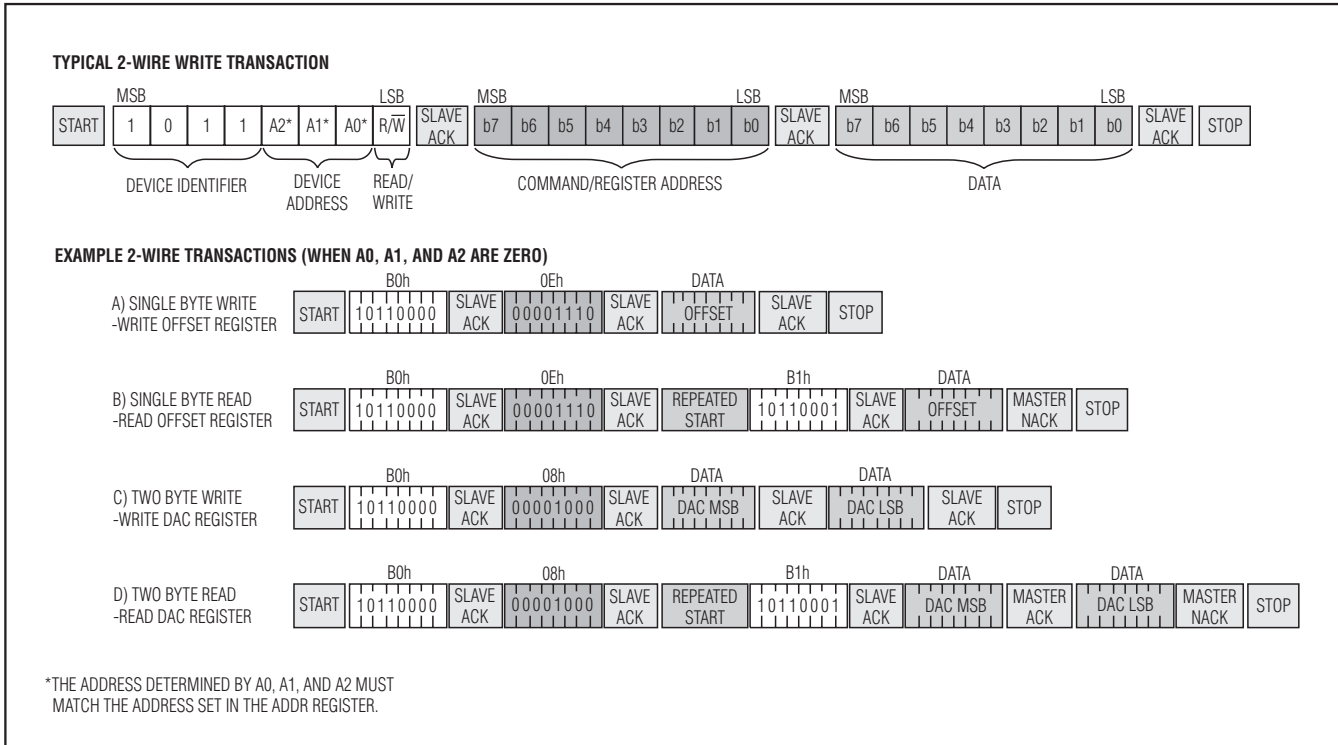

Figure 7. 2-Wire Transactions

## Chip Information

SUBSTRATE CONNECTED TO GROUND

## Package Information

For the latest package outline information and land patterns (footprints), go to [www.maxim-ic.com/packages](http://www.maxim-ic.com/packages). Note that a "+", "#", or "-" in the package code indicates RoHS status only. Package drawings may show a different suffix character, but the drawing pertains to the package regardless of RoHS status.

| PACKAGE TYPE | PACKAGE CODE | OUTLINE NO.             | LAND PATTERN NO.        |
|--------------|--------------|-------------------------|-------------------------|
| 8 $\mu$ SOP  | U8+1         | <a href="#">21-0036</a> | <a href="#">90-0092</a> |



# 3.3V Spread-Spectrum EconOscillator

## Revision History

| REVISION NUMBER | REVISION DATE | DESCRIPTION  | PAGES CHANGED |
|-----------------|---------------|--|---------------|
| 0               | 11/03         | Initial release  | —             |
| 1               | 9/07          | Updated Table 2  | 10            |
| 2               | 3/12          | Updated the <i>Ordering Information, Absolute Maximum Ratings, and Package Information</i> | 1, 2, 16      |

DS1086L

Maxim cannot assume responsibility for use of any circuitry other than circuitry entirely embodied in a Maxim product. No circuit patent licenses are implied. Maxim reserves the right to change the circuitry and specifications without notice at any time. The parametric values (min and max limits) shown in the Electrical Characteristics table are guaranteed. Other parametric values quoted in this data sheet are provided for guidance.

17 **Maxim Integrated Products, 120 San Gabriel Drive, Sunnyvale, CA 94086 408-737-7600**