

MGA-30116

150MHz – 1GHz

½ Watt High Linearity Amplifier



Data Sheet

Description

Avago Technologies' MGA-30116 is a high linearity ½ Watt PA with good OIP3 performance and exceptionally good PAE at p1dB gain compression point, achieved through the use of Avago Technologies' proprietary 0.25um GaAs Enhancement-mode pHEMT process.

The adjustable temperature compensated internal bias circuit allowed the device to be operated at either class A or class AB operation

The MGA-30116 is housed inside a standard 16 pin QFN 3X3 package.

Applications

- Class A driver amplifier for GSM/CDMA Base Stations.
- General purpose gain block.

Component Image

16 pins QFN 3x3

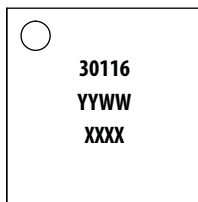

TOP VIEW

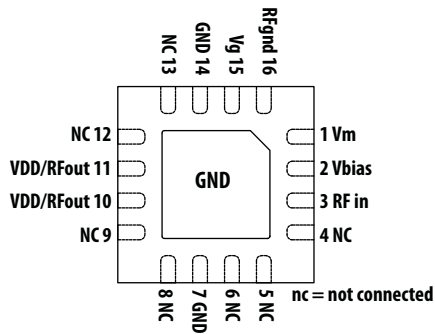

BOTTOM VIEW

Notes:

Package marking provides orientation and identification

"30116" = Device Part Number

"YYWW" = Work Week and Year of manufacture

"XXXX" = Last 4 digit of Lot number

Features

- High linearity and P1dB
- Built in adjustable temperature compensated internal bias circuitry
- GaAs E-pHEMT Technology [1]
- Standard QFN 3X3 package
- 5V supply
- Excellent uniformity in product specifications
- Tape-and-Reel packaging option available
- MSL-1 and Lead-free
- High MTTF for base station application

Specifications

900MHz; 5V, 202.8mA (typical)

- 17.0 dB Gain
- 44.1 dBm Output IP3
- 27.7 dBm Output Power at 1dB gain compression
- 47.0% PAE at P1dB
- 2.0 dB Noise Figure

Notes:

1. Enhancement mode technology employs positive gate voltage, thereby eliminating the need of negative gate voltage associated with conventional depletion mode devices.



Attention: Observe precautions for handling electrostatic sensitive devices.

ESD Machine Model = 60V

ESD Human Body Model = 300V

Refer to Avago Application Note A004R:

Electrostatic Discharge, Damage and Control.

Absolute Maximum Rating^[1] $T_A=25^\circ\text{C}$

Symbol	Parameter	Units	Absolute Max.
$V_{dd,max}$	Device Voltage, RF output to ground	V	5.5
$I_{ds,max}$	Device Drain Current	mA	400
$V_{ctrl,max}$	Control Voltage	V	5.5
$P_{in,max}$	CW RF Input Power	dBm	22
P_{diss}	Total Power Dissipation ^[3]	W	2.2
$T_{j,max}$	Junction Temperature	$^\circ\text{C}$	150
T_{STG}	Storage Temperature	$^\circ\text{C}$	-65 to 150

Thermal Resistance^[2] $\theta_{jc} = 33^\circ\text{C/W}$ ($V_{dd}=5$, $I_{ds}=200\text{mA}$, $T_c=85^\circ\text{C}$)

Notes:

1. Operation of this device in excess of any of these limits may cause permanent damage.
2. Thermal resistance measured using Infra-Red measurement technique.
3. This is limited by maximum V_{dd} and I_{ds} . Derate $30.3\text{mW}/^\circ\text{C}$ for $T_c > 77.5^\circ\text{C}$.

Electrical Specifications^[4]

$T_A = 25^\circ\text{C}$, $V_{dd} = 5\text{V}$, $V_{ctrl} = 5\text{V}$, RF performance at 900 MHz, measured on demo board (see Fig. 7) unless otherwise specified.

Symbol	Parameter and Test Condition	Units	Min.	Typ.	Max.
I_{ds}	Quiescent current	mA	165	202.8	240
I_{ctrl}	V_{ctrl} current	mA	-	7	-
Gain	Gain	dB	15.5	17.0	18.5
OIP3 ^[5]	Output Third Order Intercept Point	dBm	41	44.1	-
OP1dB	Output Power at 1dB Gain Compression	dBm	26.2	27.7	-
PAE	Power Added Efficiency	%	-	47.0	-
NF	Noise Figure	dB	-	2.0	-
S11	Input Return Loss, 50Ω source	dB	-	-14	-
S22	Output Return Loss, 50Ω load	dB	-	-14	-
S12	Reverse Isolation	dB	-	-23.5	-

Notes:

4. Measurements at 900MHz obtained using demo board described in Figure 6 and 7.
5. 900 MHz OIP3 test condition: $F_{RF1} - F_{RF2} = 10\text{MHz}$ with input power of -5dBm per tone measured at worse side band
6. Use proper biasing, heat sink and de-rating to ensure maximum channel temperature is not exceeded. See absolute maximum ratings and application note (if applicable) for more details.

Product Consistency Distribution Charts [1,2]

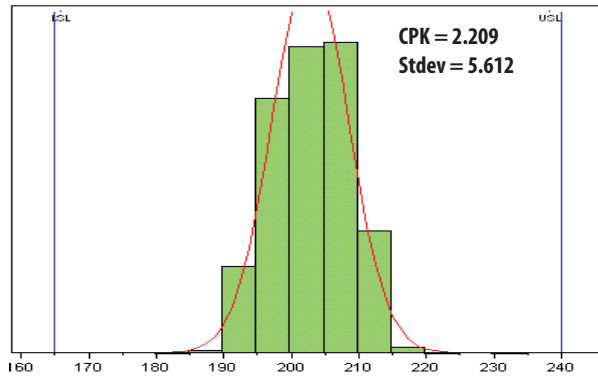

Figure 1. Ids at 900MHz; LSL=165mA, nominal =202.8mA, USL=240mA

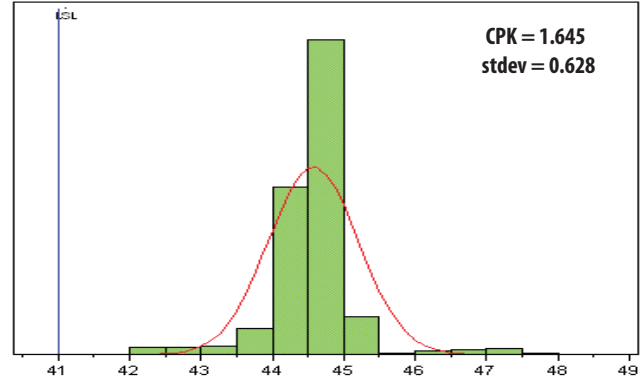

Figure 2. OIP3 at 900MHz; LSL=41dB, nominal=44.1dBm

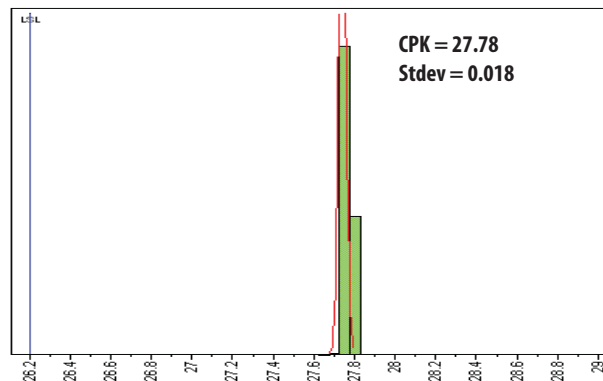

Figure 3. P1dB at 900MHz; LSL, 26.2dBm, nominal=27.7dBm

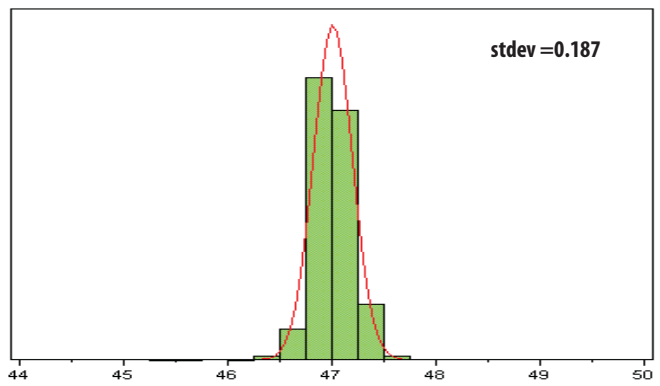

Figure 4. PAE at P1dB 900MHz; nominal=47.0%

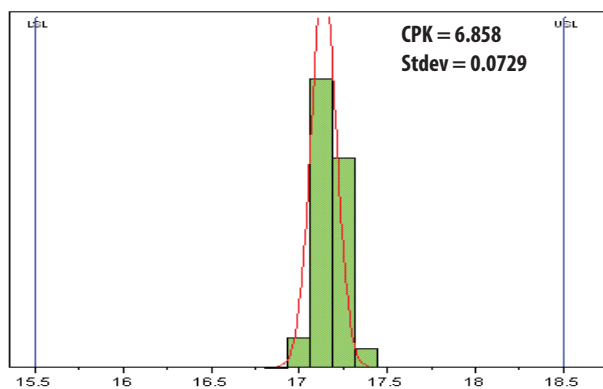

Figure 5. Gain at 900MHz; LSL=15.5dB, Nominal =17.0dB, USL=18.5dB,

Notes:

1. Distribution data sample size is 500 samples taken from 2 different wafer lots and 3 different wafers. Future wafers allocated to this product may have nominal values anywhere between the upper and lower limits.
2. Measurements were made on a characterization test board, which represents a trade-off between optimal OIP3, gain, P1dB and PAE. Circuit trace losses have not been de-embedded from measurements above.

Demo Board (750MHz to 1GHz)

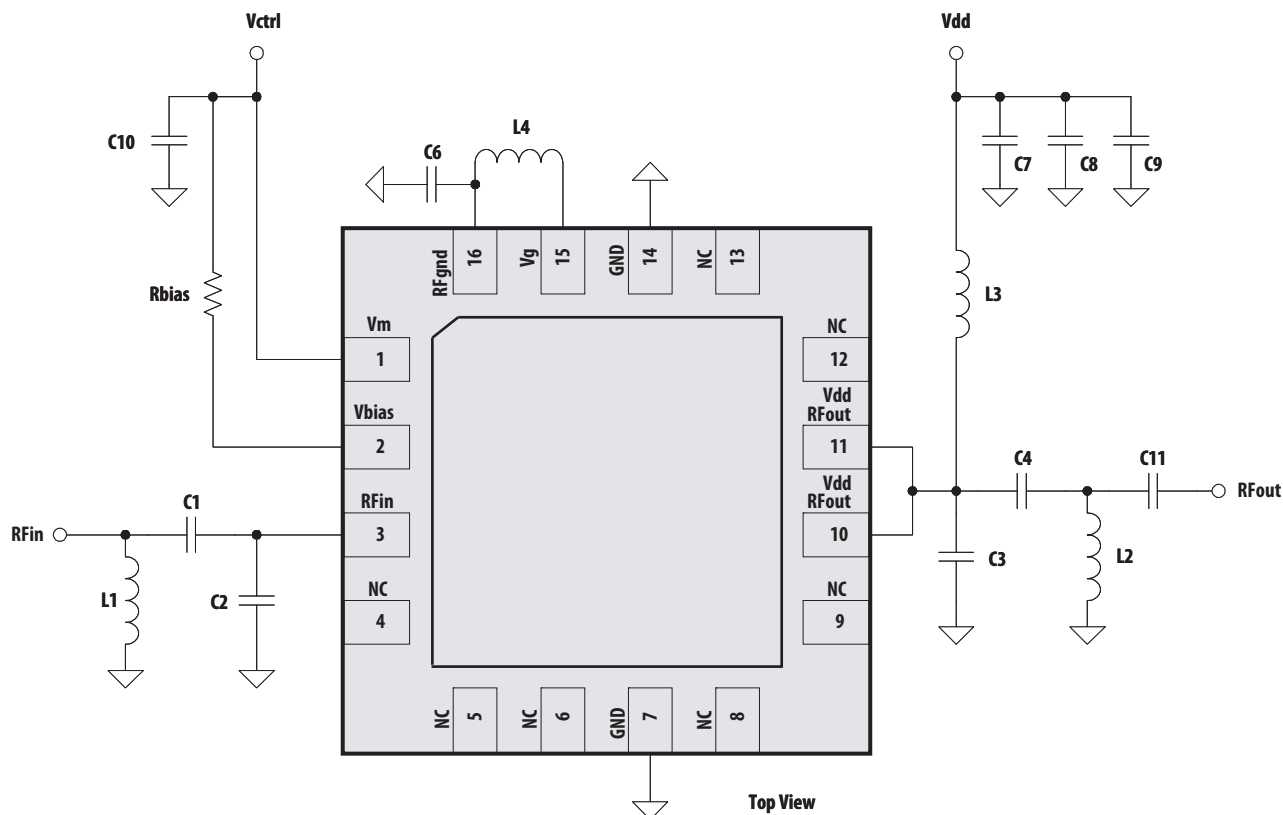

Figure 6. Demo board and application schematic (750MHz to 1GHz)

Demo Board Part List

Circuit Symbol	Size	Value	Part Number	Description
L1	0402	10nH	LLP1005-FH10NC (TOKO)	MLC Inductor
L2	0402	6.8nH	LLP1005-FH6N8C (TOKO)	MLC Inductor
L3	0402	8.2nH	LL1005-FHL8N2J (TOKO)	MLC Inductor
L4	0402	15nH	MLK1005S15NJ (TDK)	MLC Inductor
C1	0402	6pF	C1005C0G1H060D (TDK)	Ceramic Chip Capacitor
C2	0402	1.8pF	GRM1555C1H1R8CZ01B (Murata)	Ceramic Chip Capacitor
C3	0402	4.3pF	GRM1555C1H4R3CZ01B (Murata)	Ceramic Chip Capacitor
C4	0402	5.6pF	GRM1555C1H5R6CZ01B (Murata)	Ceramic Chip Capacitor
C6	0402	100pF	GRM1555C1H101JZ01B (Murata)	Ceramic Chip Capacitor
C7	0402	0.1uF	GRM155R71E103KA01B (Murata)	Ceramic Chip Capacitor
C8	0402	100pF	GRM1555C1H101JZ01B (Murata)	Ceramic Chip Capacitor
C9	0805	2.2uF	GRM21BR61E225KA12L (Murata)	Ceramic Chip Capacitor
C10	0402	100pF	GRM1555C1H101JZ01B (Murata)	Ceramic Chip Capacitor
C11	0402	100pF	GRM1555C1H101JZ01B (Murata)	Ceramic Chip Capacitor

Note: Rbias is used to lower the quiescent current. Default is 0 ohm

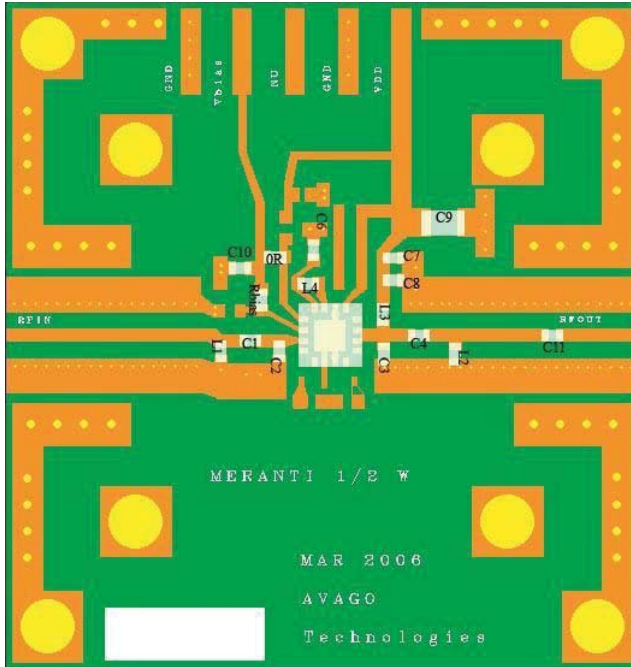

Figure 7. Demo board Layout

- Recommended PCB material is 10 mils Rogers RO4350, with FR4 backing for mechanical strength.
- Suggested component values may vary according to layout and PCB material.

MGA-30116 Typical Performance (750MHz to 1GHz)

$T_A = +25^\circ\text{C}$, $V_{dd} = 5\text{V}$, $V_{ctrl} = 5\text{V}$, Input Signal=CW unless stated otherwise.

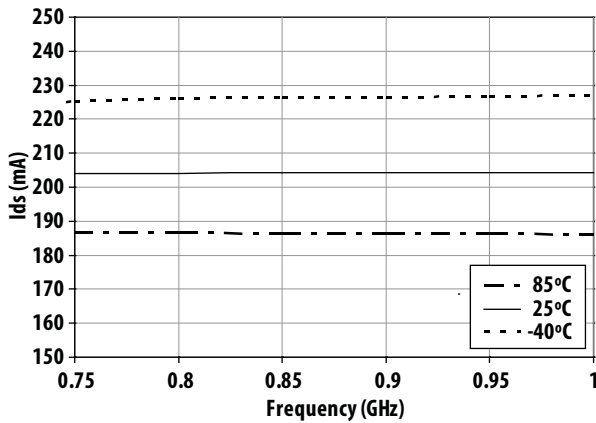

Figure 8. Over Temperature Ids vs Frequency

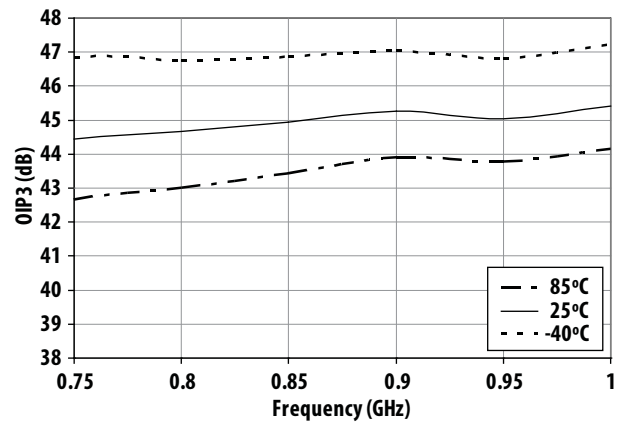

Figure 9. Over Temperature OIP3 vs Frequency

MGA-30116 Typical Performance (750MHz to 1GHz)

$T_A = +25^\circ\text{C}$, $V_{dd} = 5\text{V}$, $V_{ctrl} = 5\text{V}$, Input Signal=CW unless stated otherwise.

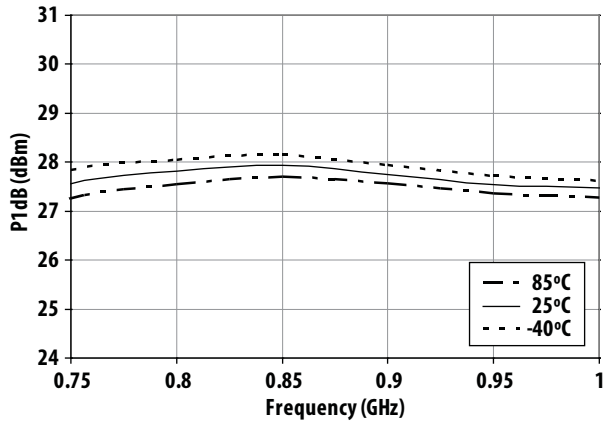

Figure 10. Over Temperature P1dB vs Frequency

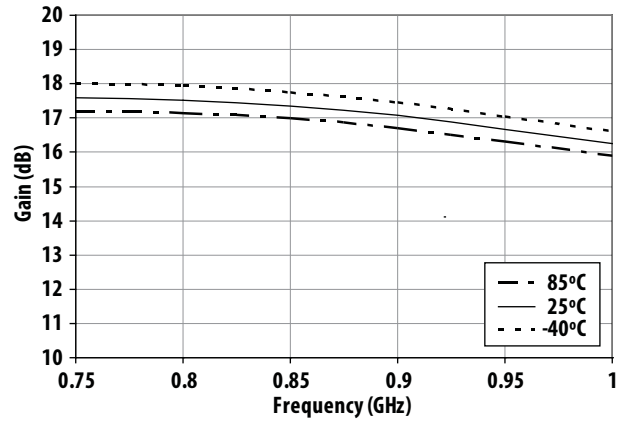

Figure 11. Over Temperature Gain vs Frequency

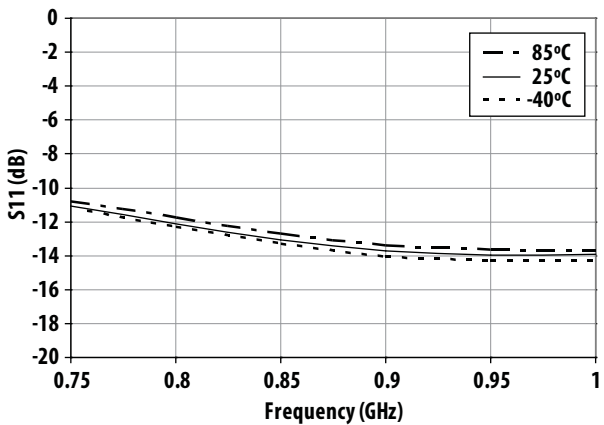

Figure 12. Over Temperature S11 vs Frequency

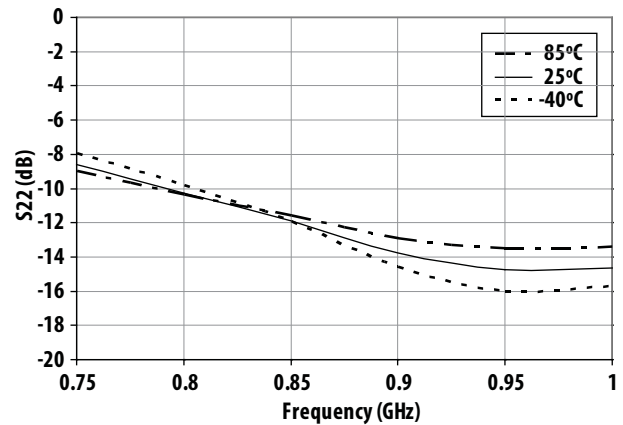

Figure 13. Over Temperature S22 vs Frequency

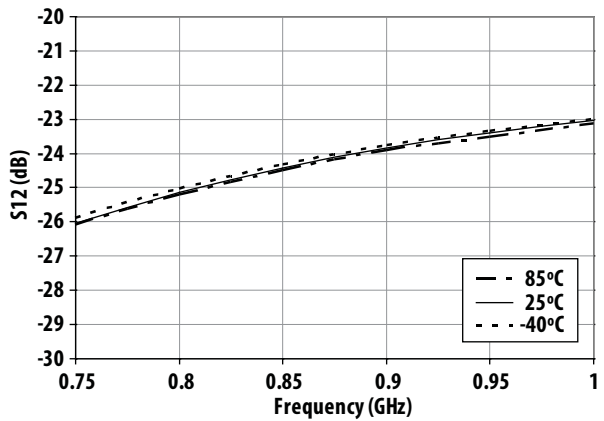

Figure 14. Over Temperature S12 vs Frequency

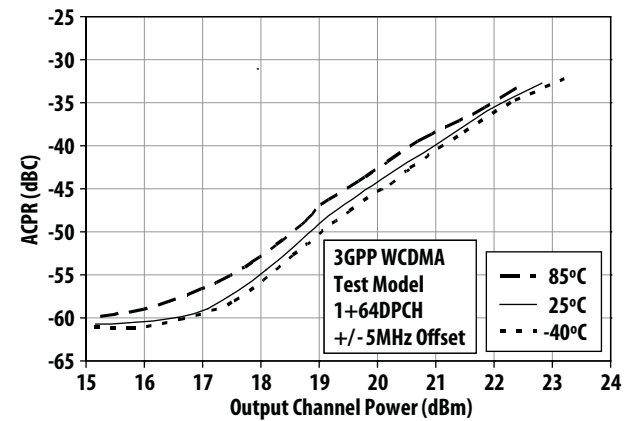

Figure 15. Over Temperature ACPR (900MHz) Vs Pout

S-Parameter (Vdd = 5V, Vctrl = 5V, T=25°C, unmatched 50 ohm)

freq (GHz)	S11 (dB)	S11 (ang)	S21 (dB)	S21 (ang)	S12 (dB)	S12 (ang)	S22 (dB)	S22 (ang)
0.1	0.819	-66.87	36.25	135.3	0.01439	56.48	0.351	-106.5
0.2	0.6424	-106.1	23.96	113.3	0.02695	48.02	0.4369	-140.2
0.3	0.5681	-130.9	17.2	101.3	0.03032	42.92	0.4617	-155.3
0.4	0.5316	-147	13.32	92.88	0.03406	41.9	0.4729	-164.7
0.5	0.5116	-159.1	10.8	86.62	0.03866	42.74	0.4766	-171.1
0.6	0.5009	-168.6	9.069	81.19	0.0432	42.68	0.4793	-176.5
0.7	0.4943	-176.6	7.799	76.55	0.04839	41.84	0.4773	179.4
0.8	0.4905	176.6	6.861	72.06	0.0529	41.61	0.4778	175.7
0.9	0.4873	170.4	6.112	68.09	0.0576	40.96	0.476	172
1	0.4857	164.9	5.514	64.13	0.06263	39.99	0.4748	169
1.5	0.4835	142.2	3.737	46.16	0.08796	31.73	0.4576	155.1
2	0.4751	123.8	2.85	28.84	0.116	20.17	0.4279	141.7
2.5	0.4638	108.1	2.356	11.91	0.1442	7.589	0.3851	128.2
3	0.4474	93.43	2.038	-5.352	0.1734	-6.182	0.3323	112.6
3.5	0.433	78.93	1.808	-23.21	0.2033	-21.36	0.2701	93.95
4	0.429	64.65	1.624	-41.21	0.2311	-37.08	0.2136	69.63
4.5	0.4433	48.8	1.456	-60.71	0.2561	-54.46	0.1842	35.57
5	0.4797	33.04	1.299	-79.6	0.2706	-71.5	0.1845	-0.1869
5.5	0.5308	17.84	1.145	-98.31	0.2812	-88.72	0.1949	-28.5
6	0.5849	4.304	0.9923	-117	0.28	-105.5	0.1758	-50.71
6.5	0.6311	-6.453	0.8475	-134.2	0.2682	-121.8	0.09589	-63.29
7	0.6711	-15.37	0.6847	-151.2	0.25	-136.4	0.1006	46.42
7.02	0.6718	-15.54	0.6791	-151.4	0.2488	-136.8	0.1055	47.03
7.5	0.702	-22.92	0.5296	-161.9	0.2195	-145.6	0.3269	34.85
8	0.7192	-30.47	0.4375	-163.6	0.2083	-148.2	0.5113	11.84
8.5	0.7036	-38.8	0.4401	-164	0.2316	-150.2	0.5983	-9.504
9	0.6344	-44.46	0.4975	-172.7	0.2788	-159.9	0.5515	-29.89
9.5	0.623	-48.02	0.4827	163.9	0.2918	176.7	0.4055	-20.64
10	0.6313	-59.65	0.3887	164.1	0.2573	176.4	0.5668	-27.29
10.5	0.5825	-75.16	0.445	162.5	0.3127	172.2	0.5751	-46.67
11	0.5164	-91.87	0.5292	151.8	0.3834	161.5	0.5242	-66.71
11.5	0.4614	-109.1	0.6084	136.6	0.4587	145.2	0.4551	-90.35
12	0.4244	-125.4	0.668	119	0.5192	126.1	0.3841	-118.8
12.5	0.4056	-142.1	0.6845	101.1	0.5644	107.3	0.2985	-144.4
13.5	0.385	-156.5	0.7347	84.24	0.6157	90.41	0.3366	-168.2
14	0.3726	-176	0.7055	49.21	0.6262	53.26	0.4046	138
14.5	0.3731	166.5	0.736	33.92	0.6716	36.92	0.3906	113.9
15	0.3205	148.6	0.7673	16.35	0.7162	18.91	0.3296	95.44
15.5	0.2225	132.8	0.8008	-3.142	0.7613	-1.432	0.2269	86.25
16	0.08651	165.7	0.8194	-25.57	0.7898	-24.97	0.1099	119.9
16.5	0.2734	-144.7	0.776	-51.48	0.7658	-52.01	0.2566	174.7
17	0.5265	-164	0.6454	-76.43	0.6397	-78.62	0.5016	168
17.5	0.6917	176.9	0.4937	-95.96	0.5045	-99.26	0.6825	155.3
18	0.778	164.8	0.3822	-108.9	0.3851	-112.5	0.7874	146.4
18.5	0.8257	157.3	0.3054	-118.3	0.316	-122.4	0.8485	140.4
19	0.8475	153.3	0.2549	-124.5	0.261	-128.5	0.8782	137
19.5	0.8593	151.2	0.2233	-128.9	0.2331	-134.3	0.8881	134.9
20	0.8592	150.1	0.2099	-132.6	0.2211	-137.5	0.8915	133.4

Note: Circuit layout refer to Figure 16.

S-Parameter Test circuit

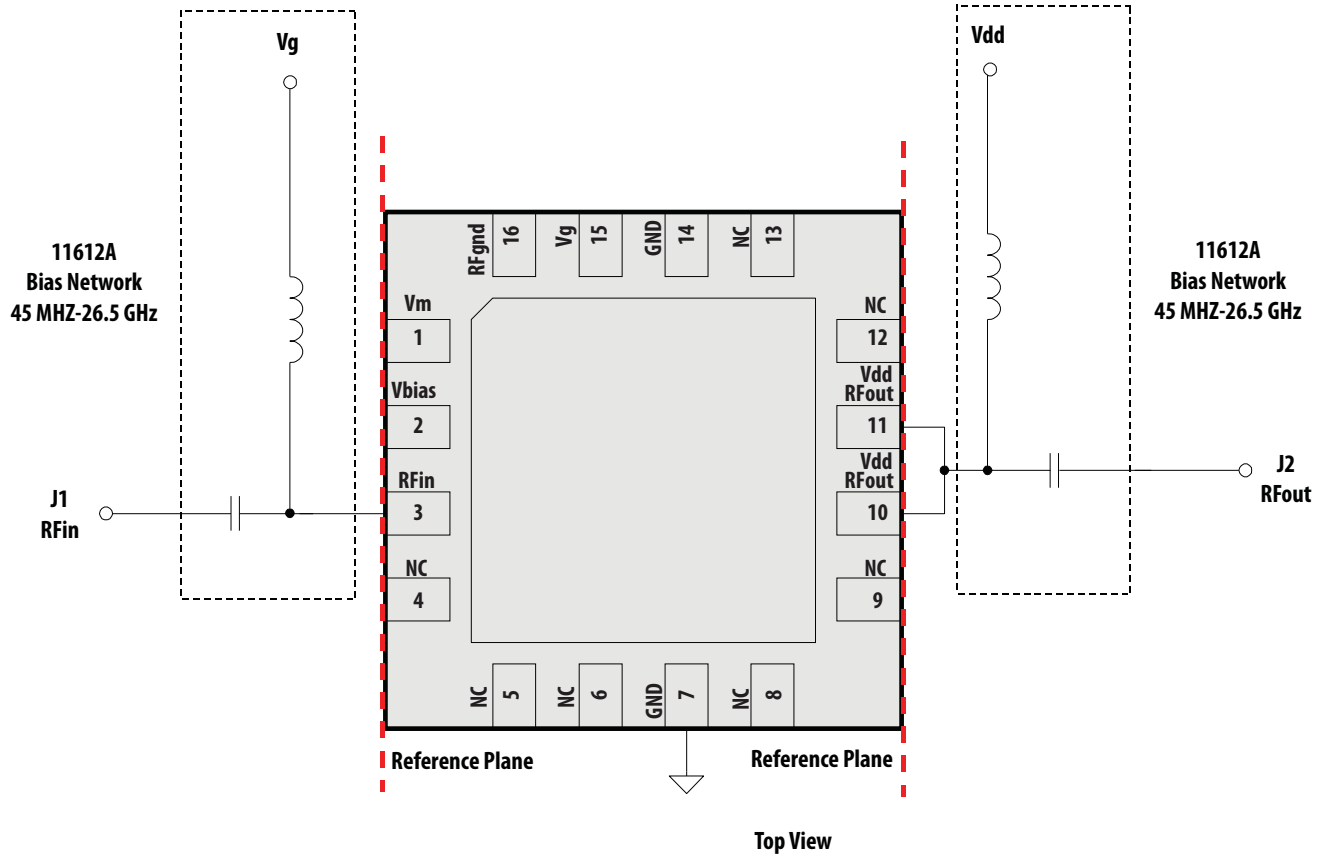

Figure 16. S-Parameter Test circuit.

S-Parameter (Vdd = 5V, Vctrl = 5V, T=25°C, unmatched 50 ohm), with L4 = 15nH, C6 = 100pF

freq (GHz)	S11 (dB)	S11 (ang)	S21 (dB)	S21 (ang)	S12 (dB)	S12 (ang)	S22 (dB)	S22 (ang)
0.1	0.2568	161.2	13.78	175.8	0.009444	101.7	0.2746	-34.24
0.2	0.1672	164.7	15.64	160.5	0.01771	93.57	0.4101	-66.49
0.3	0.1339	-153.1	16.74	141.1	0.02985	83.91	0.5896	-96.1
0.4	0.2804	-144.2	14.9	117.7	0.03976	67.74	0.6465	-126.2
0.5	0.3701	-158.3	12.01	102.7	0.04382	57.22	0.6219	-144.3
0.6	0.4127	-169.5	9.849	92.68	0.04783	54.35	0.5948	-155.9
0.7	0.434	-178.1	8.307	85.46	0.05033	50.56	0.5741	-164.1
0.8	0.4476	174.6	7.201	79.36	0.05531	48.96	0.5571	-170.5
0.9	0.456	168.5	6.349	74.28	0.05979	46.76	0.5467	-176
1	0.4621	162.9	5.684	69.52	0.06393	44.7	0.537	179.6
1.5	0.474	140.1	3.742	49.18	0.0896	34.64	0.5022	161.6
2	0.4713	122.3	2.861	31.48	0.1158	22.85	0.4649	146.8
2.5	0.4595	106.4	2.36	14.01	0.1449	9.838	0.4205	132.1
3	0.4391	93.36	2.029	-3.058	0.1725	-3.918	0.3676	116.7
3.5	0.43	78.17	1.806	-21.48	0.2036	-19.57	0.301	96.73
4	0.416	64.62	1.611	-40.19	0.2316	-35.9	0.2393	71.35
4.5	0.4298	53.2	1.464	-57	0.2534	-51.13	0.2033	41.6
5	0.4771	36.4	1.298	-78.1	0.2707	-70.57	0.1884	1.547
5.5	0.529	21.01	1.14	-97.23	0.2796	-87.99	0.185	-29.27
6	0.5852	7.048	0.9772	-116.3	0.2741	-105	0.1468	-54.03
6.5	0.6344	-4.632	0.8161	-134.1	0.2564	-121.2	0.04241	-50.92
7	0.6793	-14.22	0.6446	-149.4	0.2351	-133.6	0.1712	53.21
7.5	0.7121	-22.65	0.4994	-157.8	0.2102	-140.4	0.3948	31.35
8	0.7198	-30.56	0.4489	-158.4	0.2158	-142.5	0.5287	6.43
8.5	0.7155	-37.25	0.3997	-161.6	0.2157	-147.8	0.6248	-6.672
9	0.6895	-44.03	0.4167	-163.8	0.242	-151.7	0.6518	-21.27
9.5	0.6597	-51.88	0.4662	-169.9	0.287	-159.2	0.6371	-34.6
10	0.6101	-61.74	0.5308	179.8	0.3463	-169.5	0.596	-47.68
10.5	0.5423	-73.63	0.6054	167.2	0.4186	176.2	0.5318	-63.41
11	0.4595	-87.08	0.6852	149.4	0.4918	159.2	0.4226	-81.47
11.5	0.404	-98.92	0.7138	132	0.5402	140.2	0.359	-100.4
12	0.3637	-116.4	0.744	115.6	0.5821	121.9	0.3031	-125.5
12.5	0.3447	-131.9	0.767	97.51	0.623	103.1	0.2751	-154.6
13	0.3432	-151	0.784	79.81	0.6501	85.67	0.2787	176.6
13.5	0.3322	-171	0.7906	61.96	0.6802	67.27	0.3048	151.7
14	0.2999	170.4	0.776	43.77	0.6889	48.08	0.3259	133.6
14.5	0.2504	155.7	0.7477	27.31	0.6811	30.17	0.3555	116
15	0.211	147.3	0.7599	13.03	0.7052	15.74	0.3124	93.28
15.5	0.1448	140	0.8115	-5.748	0.7699	-3.878	0.1677	81.45
16	0.1042	-155.1	0.8283	-28.92	0.8003	-28.21	0.09555	169
16.5	0.3274	-145.4	0.769	-55.06	0.7618	-55.63	0.3365	-176.2
17	0.5576	-166.2	0.6286	-79.44	0.6235	-81.61	0.5759	169.1
17.5	0.7072	175.6	0.4753	-97.98	0.4856	-101.6	0.7331	155.1
18	0.7852	164.1	0.3653	-109.8	0.3679	-113.4	0.8093	146.1
18.5	0.8251	157	0.2913	-117.8	0.3018	-122.1	0.8536	140.4
19	0.844	153.6	0.2531	-123	0.2596	-127.1	0.877	137.2
19.5	0.8577	151.5	0.2235	-128.5	0.2327	-133.7	0.8891	135.3
20	0.8584	150.2	0.2104	-132	0.2192	-137.1	0.8957	133.5

Note: Circuit layout refer to Figure 17, with L4 = 15 nH, C6 = 100pF

S-Parameter (Vdd = 5V, Vctrl = 5V, T=25°C,unmatched 50 ohm), with L4 = 100nH, C6 = 1nF

freq (GHz)	S11 (dB)	S11 (ang)	S21 (dB)	S21 (ang)	S12 (dB)	S12 (ang)	S22 (dB)	S22 (ang)
0.1	0.5555	10.29	35.34	174.2	0.01595	110.7	0.4953	-65.36
0.2	0.5652	-85.53	27.11	125.1	0.02909	57.57	0.5617	-125.6
0.3	0.5267	-124	18.44	106.2	0.03285	48.87	0.5286	-148
0.4	0.508	-144.3	13.83	95.53	0.03656	46.17	0.5126	-160.7
0.5	0.4988	-157.9	11.03	88.31	0.04119	45.19	0.5023	-168.4
0.6	0.4939	-168.1	9.165	82.26	0.04457	44.09	0.4972	-174.9
0.7	0.491	-176.3	7.837	77.29	0.04883	43.54	0.49	-179.7
0.8	0.4886	176.9	6.869	72.51	0.05316	42.65	0.4852	176.2
0.9	0.4882	170.7	6.104	68.36	0.05725	41.06	0.4794	172.2
1	0.4864	164.6	5.426	63.68	0.06378	39.49	0.474	168.2
1.5	0.4837	142.8	3.708	45.42	0.08746	30.28	0.4467	153.3
2	0.4758	124.9	2.815	27.12	0.1145	18.41	0.3984	138.4
2.5	0.4643	110.1	2.305	8.764	0.1405	3.984	0.3289	123.2
3	0.4577	97.19	1.953	-9.91	0.161	-10.33	0.2475	106.1
3.5	0.4543	83.77	1.654	-30	0.1863	-26.26	0.1208	86.57
4	0.4629	71.65	1.32	-49.22	0.1997	-44.31	0.03653	-178
4.5	0.5275	55.55	1.034	-60.21	0.1803	-56.57	0.1689	165.4
5	0.5184	35.23	1.154	-72.72	0.2383	-64.62	0.1434	60.22
5.5	0.5989	22.32	0.8585	-95.63	0.2059	-84.56	0.1319	130.6
6	0.657	5.12	0.7102	-103.2	0.2058	-88.56	0.303	76.52
6.5	0.6875	-8.43	0.6763	-112.5	0.228	-98.33	0.4378	37.31
7	0.7137	-18.74	0.6198	-123.6	0.2438	-109.7	0.5354	14.7
7.5	0.7241	-27.56	0.5931	-133.6	0.2581	-120.6	0.602	-4.645
8	0.718	-34.72	0.5767	-143.5	0.2772	-131.7	0.619	-19.73
8.5	0.691	-40.68	0.574	-156	0.2962	-145	0.5626	-31.17
9	0.681	-46.15	0.5259	-162	0.294	-151.2	0.597	-34.04
9.5	0.6393	-53.84	0.585	-170.5	0.347	-160.2	0.5657	-48.44
10	0.5788	-62.6	0.6443	176.5	0.4063	-172.9	0.4858	-60.16
10.5	0.5028	-72.36	0.6962	161.6	0.4677	171.4	0.3994	-71.89
11	0.4265	-84.11	0.7372	145.1	0.5198	155.6	0.3199	-85.13
11.5	0.3683	-97.04	0.7685	128.3	0.574	137.7	0.2552	-104.2
12	0.335	-117	0.7789	112.7	0.6045	120.7	0.2232	-123.8
12.5	0.291	-137.5	0.8156	95.6	0.6712	102.2	0.2332	-159.9
13	0.2902	-156.5	0.8394	77.54	0.7033	83.72	0.2479	164.5
13.5	0.2995	-175.6	0.8415	59.73	0.728	65.05	0.2676	137.2
14	0.2998	166.6	0.8388	42.03	0.7442	46.45	0.2708	117.2
14.5	0.2813	150.2	0.8378	24.27	0.7641	27.53	0.2565	102
15	0.2247	137	0.8449	5.782	0.7925	8.6	0.1958	85.32
15.5	0.1216	146.5	0.8498	-15	0.8132	-13.14	0.06727	93.91
16	0.1879	-152.9	0.8167	-38.64	0.7948	-37.8	0.1754	-166.3
16.5	0.4125	-159.5	0.7132	-62.79	0.711	-63.33	0.4122	-179
17	0.6075	-175.1	0.5777	-84.42	0.5747	-86.65	0.618	166.5
17.5	0.7305	170.5	0.4383	-100.8	0.4495	-104.4	0.7513	153.2
18	0.795	161.6	0.3427	-111.1	0.3447	-114.9	0.8168	144.9
18.5	0.8315	156	0.2809	-119.2	0.2901	-123.2	0.8596	139.9
19	0.8501	152.7	0.2379	-124.7	0.2442	-128.7	0.8821	136.6
19.5	0.8572	150.8	0.2114	-129.4	0.2222	-134.3	0.8914	134.5
20	0.8568	149.6	0.2022	-132.8	0.2114	-137.5	0.8967	133.1

Note: Circuit layout refer to Figure 17, with L4 = 100 nH, C6 = 1nF

S-Parameter Test circuit (400MHz – 700 MHz)

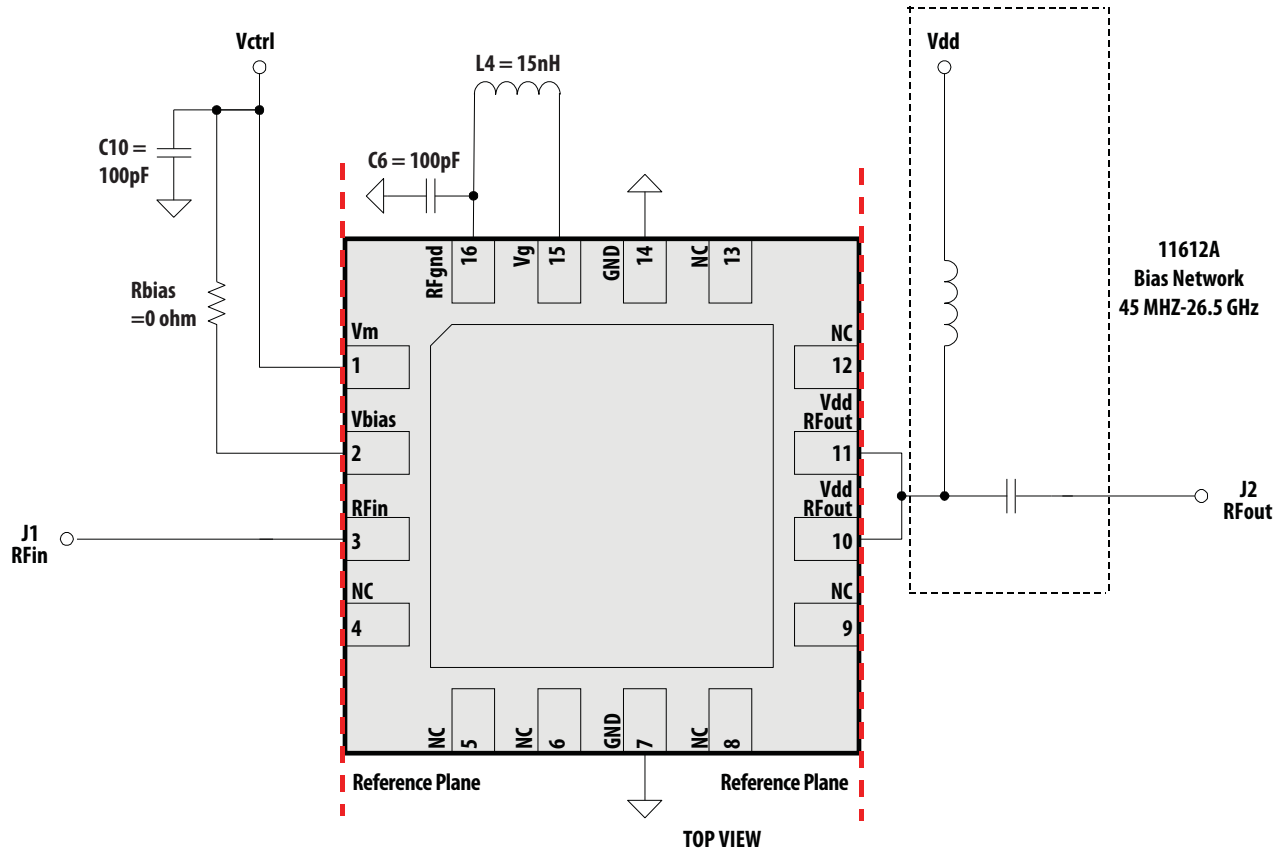

Figure 17. S-Parameter Test Circuit.

Demo Board (400MHz to 700MHz)

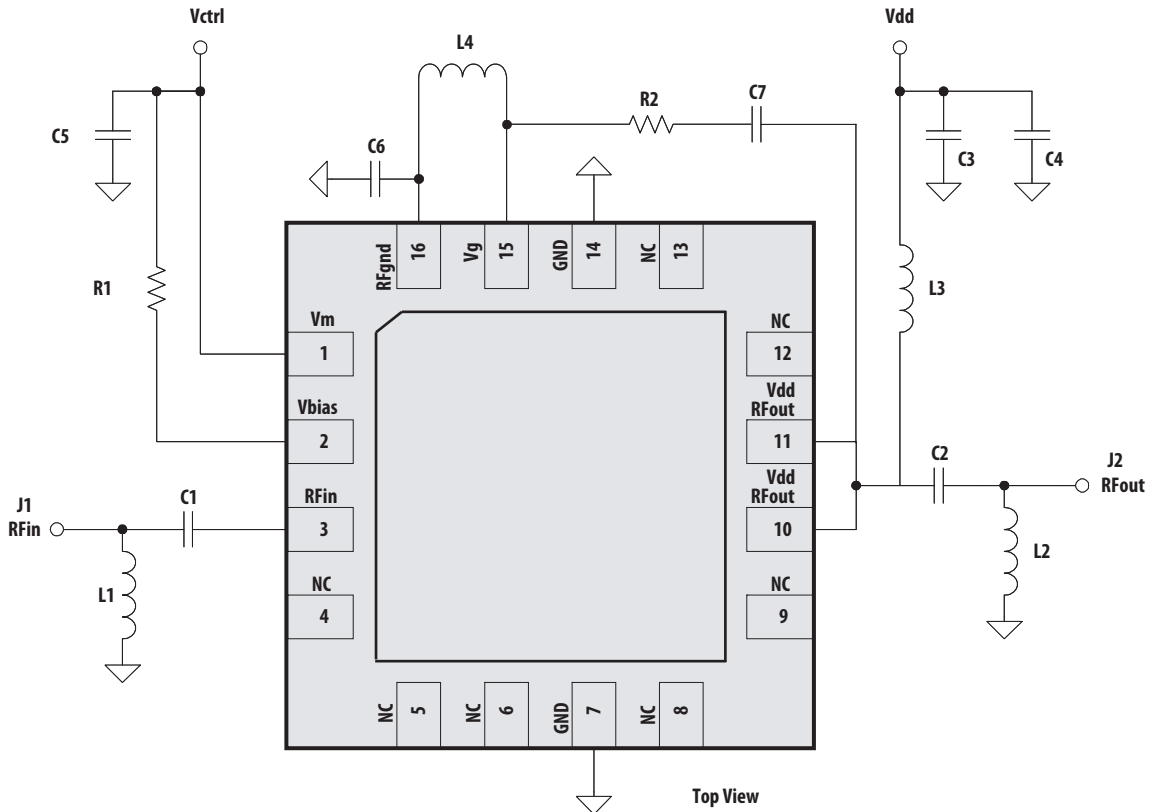

Figure 18. Demo board and application schematic (400MHz to 700 MHz)

Demo Board Part List (400MHz to 700MHz)

Circuit Symbol	Value	Part Number
C1	10 pF	Murata GRM155 series
C2	10p	Murata GRM155 series
C3	1 nF	Murata GRM155 series
C4	100 nF	Murata GRM155 series
C5	1 nF	Murata GRM155 series
C6	1 nF	Murata GRM155 series
C7	1 nF	Murata GRM155 series
J1	142-0701-841	Johnson edge launch SMA female
J2	142-0701-841	Johnson edge launch SMA female
L1	22 nH	Toko LL1005 series
L2	15 nH	Toko LL1005 series
L3	100 nH	Toko LL1005 series
L4	100 nH	Toko LL1005 series
Q1	Mga30116	
R1	0 R	
R2	390 R	

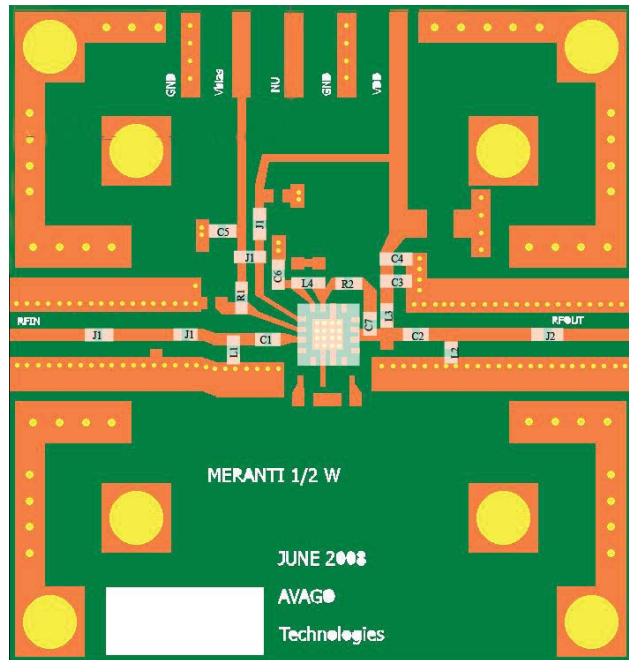

Figure 19. Demo board Layout for 400MHz to 700MHz

Notes:

1. Recommended PCB material is 10 mils Rogers RO4350, with FR4 backing for mechanical strength.
2. Suggested component values may vary according to layout and PCB material.

MGA-30116 Typical Performance (400MHz to 700MHz)

$T_A = +25^\circ\text{C}$, $V_{dd} = 5\text{V}$, $V_{ctrl} = 5\text{V}$, Input Signal=CW unless stated otherwise.

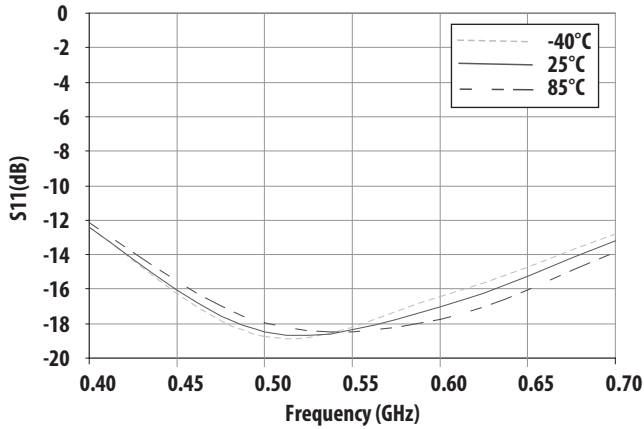

Figure 20. Over Temperature S11 vs Frequency

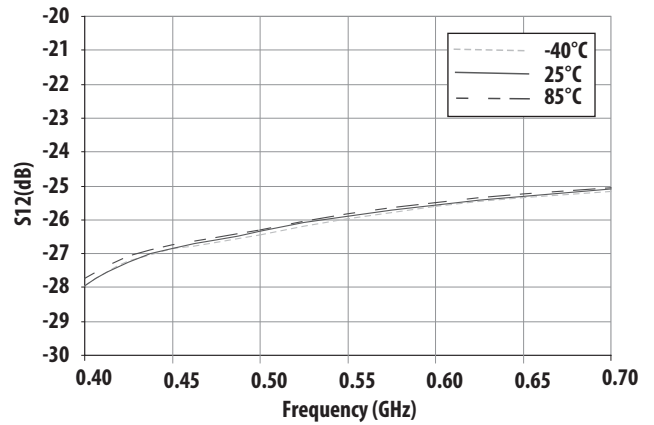

Figure 21. Over Temperature S12 vs Frequency

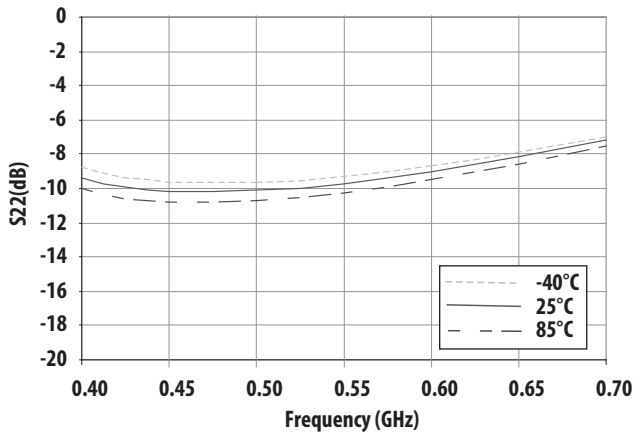

Figure 22. Over Temperature S22 vs Frequency

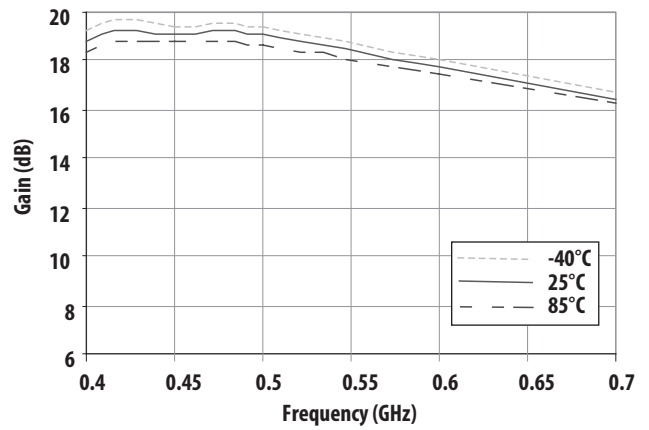

Figure 23. Over Temperature Gain vs Frequency

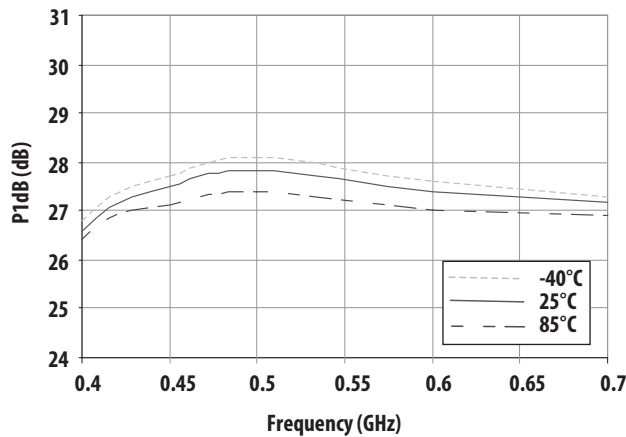

Figure 24. Over Temperature P1dB vs Frequency

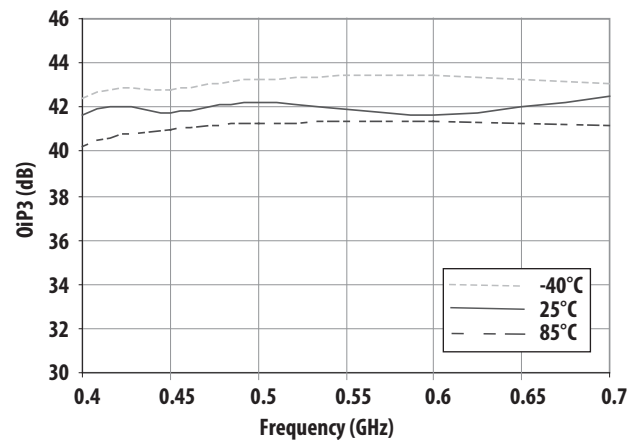
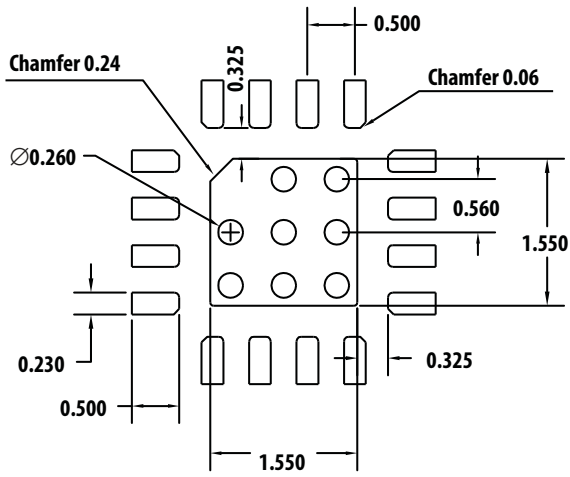
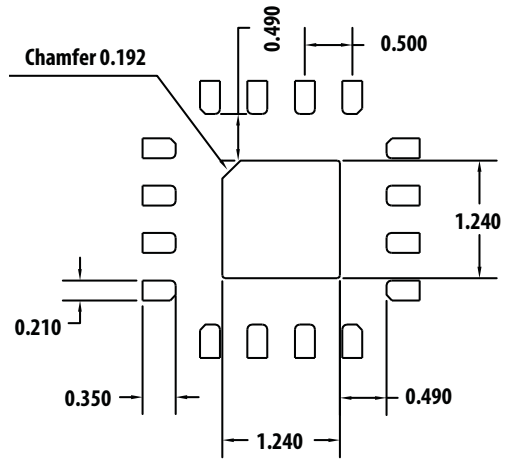

Figure 25. Over Temperature OIP3 vs Frequency

PCB Layout and Stencil Design



**PCB Land Pattern
(Top View)**



Stencil Outline

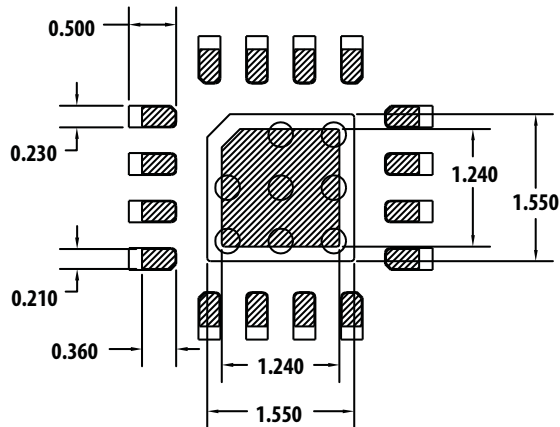

Combined PCB & Stencil Layouts

Notes:

1. All dimensions are in millimeters.

Part Number Ordering Information

Part Number	No. of Devices	Container
MGA-30116-TR1G	1000	7" Reel
MGA-30116-TR2G	3000	13" Reel
MGA-30116-BLKG	100	antistatic bag

Product Family

Output Power	Frequency Band		
	700MHz-1GHz	1.7- 2.7GHz	3.3-3.9GHz
0.5W	MGA-30116	MGA-30216	MGA-30316
1W	ALM-31122	ALM-31222	ALM-31322
2W	ALM-32120	ALM-32220	ALM-32320

Note: MGA-30116 operates from 400MHz to 1GHz.

Package Dimensions

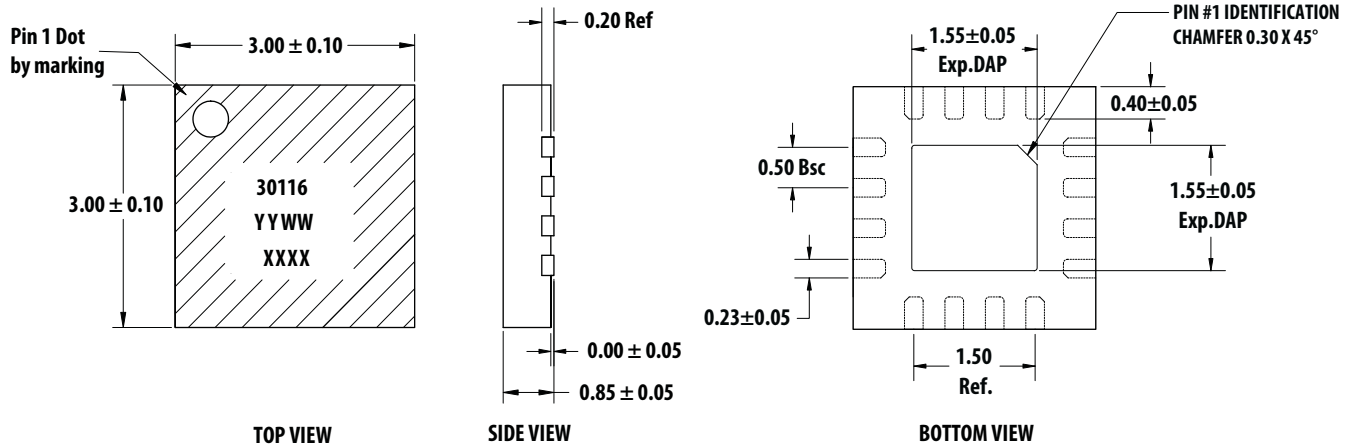

Notes:

1. All dimensions are in millimeters
2. Dimensions are inclusive of plating
3. Dimensions are exclusive of mold flash and metal burr

Device Orientation

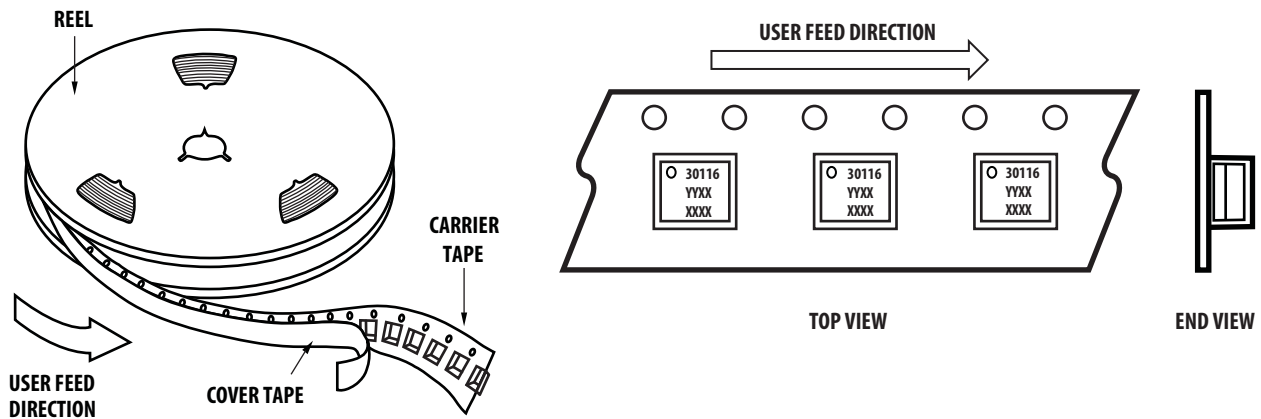

Tape Dimensions

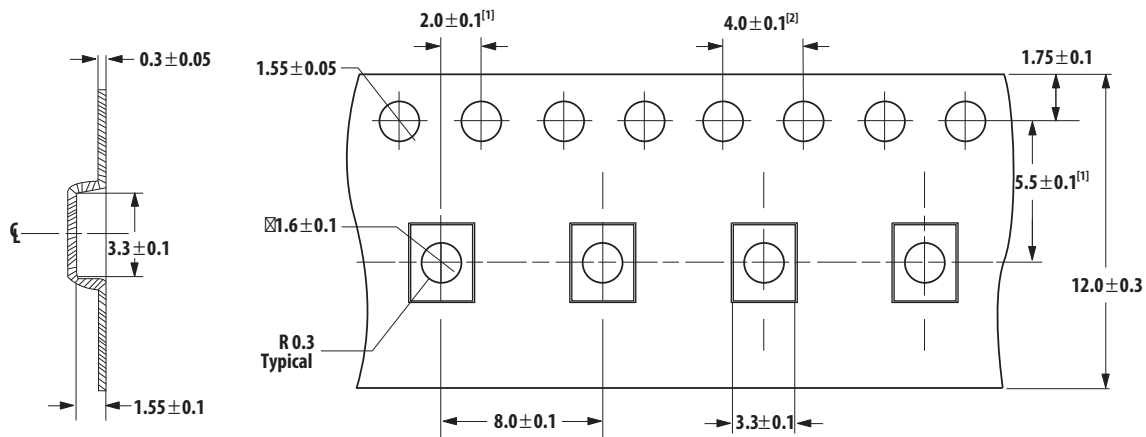

Notes:

1. Measured from centerline of sprocket hole to centerline of pocket
2. Cumulative tolerance of 10 sprocket holes is ± 0.20
3. All dimensions in millimeter unless otherwise stated

Reel Dimensions - 7 inch

