



## 16-BIT, HIGH-SPEED, LOW-NOISE, VOLTAGE OUTPUT DIGITAL-TO-ANALOG CONVERTER

Check for Samples: [DAC8581](#)

### FEATURES

- 16-Bit Monotonic
- $\pm 5$ -V Bipolar Output
- Very Low Glitch: 0.5 nV-s
- Fast Settling: 0.65  $\mu$ s
- Fast Slew Rate: 35 V/ $\mu$ s
- Low Noise: 20 nV/ $\sqrt{\text{Hz}}$
- $\pm 25$ -mA Load Drive
- $\pm 5$ -V Dual Power Supply
- Single External Reference
- Power-On Reset to Midscale
- 3-MSPS Update Rate
- SPI™ Interface, Up to 50 MHz
- 1.8-V–5-V Logic Compatible
- Twos Complement Data Format
- Hardware Reset to Midscale
- TSSOP-16 Package

### APPLICATIONS

- Industrial Process Control
- CRT Projection TV Digital Convergence
- Waveform Generation
- Automated Test Equipment
- Ultrasound

### DESCRIPTION

The DAC8581 is a 16-bit, high-speed, low-noise DAC operating from dual  $\pm 5$ -V power supplies. The DAC8581 is monotonic, and has exceptionally low noise and exceptionally low glitch. The DAC8581 high-performance, bipolar output buffer is capable of settling within 0.65  $\mu$ s for a 10-V step. Small-signal settling time is well under 0.3  $\mu$ s, supporting data update rates up to 3 MSPS. A power-on-reset circuit sets the output at midscale voltage on power up.

The DAC8581 is simple to use, with a single external reference and a standard 3-wire SPI interface that allows clock rates up to 50 MHz.

Also see the [DAC8580](#), a member of the same family. The DAC8580 combines DAC8581 performance with an on-chip, 16x over-sampling digital filter.

The DAC8581 is specified over the  $-40^{\circ}\text{C}$  to  $+85^{\circ}\text{C}$  temperature range.

FUNCTIONAL BLOCK DIAGRAM OF DAC8581

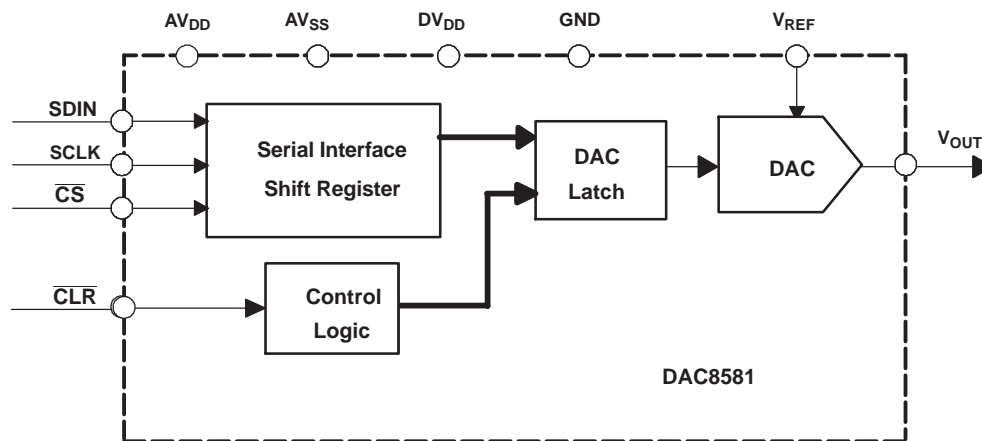

Please be aware that an important notice concerning availability, standard warranty, and use in critical applications of Texas Instruments semiconductor products and disclaimers thereto appears at the end of this data sheet.

SPI is a trademark of Motorola.

All other trademarks are the property of their respective owners.



This integrated circuit can be damaged by ESD. Texas Instruments recommends that all integrated circuits be handled with appropriate precautions. Failure to observe proper handling and installation procedures can cause damage.

ESD damage can range from subtle performance degradation to complete device failure. Precision integrated circuits may be more susceptible to damage because very small parametric changes could cause the device not to meet its published specifications.

### PACKAGE/ORDERING INFORMATION<sup>(1)</sup>

PRODUCT	PACKAGE	PACKAGE DRAWING NUMBER	SPECIFICATION TEMPERATURE RANGE	PACKAGE ORDERING MARKING	ORDERING NUMBER	TRANSPORT MEDIA, QUANTITY
DAC8581	TSSOP-16	PW	–40°C to +85°C	D8581I	DAC8581IPW	Tube, 90-Piece
					DAC8581IPWR	Tape and Reel, 2000-Piece

- (1) For the most current package and ordering information, see the Package Option Addendum at the end of this document, or see the TI web site at [www.ti.com](http://www.ti.com).

### ABSOLUTE MAXIMUM RATINGS<sup>(1)</sup>

		UNIT
AV <sub>DD</sub> or DV <sub>DD</sub> to AV <sub>SS</sub>		–0.3 V to 12 V
Digital input voltage to AV <sub>SS</sub>		–0.3 V to 12 V
V <sub>OUT</sub> or V <sub>REF</sub> to AV <sub>SS</sub>		–0.3 V to 12 V
DGND and AGND to AV <sub>SS</sub>		–0.3 V to 6 V
Operating temperature range		–40°C to +85°C
Storage temperature range		–65°C to +150°C
Junction temperature range (T <sub>J</sub> max)		+150°C
Power dissipation	Thermal impedance (θ <sub>JA</sub> )	118°C/W
	Thermal impedance (θ <sub>JC</sub> )	29°C/W

- (1) Stresses above those listed under *Absolute Maximum Ratings* may cause permanent damage to the device. Exposure to absolute maximum conditions for extended periods may affect device reliability.

## ELECTRICAL CHARACTERISTICS

 All specifications at  $T_A = T_{MIN}$  to  $T_{MAX}$ ,  $+AV_{DD} = +5\text{ V}$ ,  $-AV_{DD} = -5\text{ V}$ ,  $DV_{DD} = +5\text{ V}$  (unless otherwise noted).

PARAMETER	TEST CONDITIONS	DAC8581			UNIT
		MIN	TYP	MAX	
<b>STATIC PERFORMANCE</b>					
Resolution		16			Bits
Linearity error	$V_{REF} = 4.096\text{ V}$		$\pm 0.03$	$\pm 0.1$	%FS
Differential linearity error			$\pm 0.25$	$\pm 0.5$	LSB
Gain error		1	2	3	%FS
Gain drift			$\pm 5$		ppm/°C
Bipolar zero error			-5	$\pm 25$	mV
Bipolar zero drift			$\pm 20$		$\mu\text{V}/^\circ\text{C}$
Total drift			$\pm 10$		ppm/°C
<b>OUTPUT CHARACTERISTICS</b>					
Voltage output	$V_{REF}$ up to 5.5 V, when $AV_{DD} = 6\text{ V}$ , $AV_{SS} = -6\text{ V}$	$-V_{REF}$		$V_{REF}$	V
Output impedance			1		$\Omega$
Maximum output current			$\pm 25$		mA
Settling time	$C_L < 200\text{ pF}$ , $R_L = 2\text{ k}\Omega$ , to 0.1% FS, 8-V step		0.65		$\mu\text{s}$
	To 0.003% FS		1		
Slew rate <sup>(1)</sup>			35		V/ $\mu\text{s}$
Code change glitch	1 LSB change around major carry		0.5		nV-S
Overshoot	Full-scale change		50		mV
Digital feedthrough <sup>(2)</sup>			0.5		nV-S
SNR	Digital sine wave input, $f_{OUT} = 1\text{ kHz}$ , BW = 10 kHz, 2-MSPS update rate		108		dB
THD	Digital sine wave input, $f_{OUT} = 20\text{ kHz}$ , 8- $V_{PP}$ output, 2-MSPS update rate		-72		dB
Output voltage noise	0.1 Hz to 10 Hz		25		$\mu\text{V}_{PP}$
	At 10-kHz offset frequency		25		$\text{nV}/\sqrt{\text{Hz}}$
	At 100-kHz offset frequency		20		$\text{nV}/\sqrt{\text{Hz}}$
Power supply rejection	$V_{DD}$ varies $\pm 10\%$		0.75		mV/V
<b>REFERENCE</b>					
Reference input bandwidth	Large signal: 2- $V_{PP}$ sine wave on 4 V DC		3		MHz
	Small signal: 100-mV $_{PP}$ sine wave on 4 V DC		10		MHz
Reference input voltage range		3		$AV_{DD}$	V
Reference input impedance			5		k $\Omega$
Reference input capacitance			5		pF
<b>DIGITAL INPUTS</b>					
$V_{IH}$				$0.7 \times DV_{DD}$	V
$V_{IL}$		GND		$0.3 \times DV_{DD}$	
Input current				$\pm 1$	$\mu\text{A}$
Input capacitance				10	pF
Power-on delay	From $V_{DD}$ high to $\overline{CS}$ low		20		$\mu\text{s}$

(1) Slew rate is measured from 10% to 90% of transition when the output changes from 0 to full-scale.

(2) Digital feedthrough is defined as the impulse injected into the analog output from the digital input. It is measured when the DAC output does not change,  $\overline{CS}$  is held high, and while SCLK and SDIN signals are toggled.

## ELECTRICAL CHARACTERISTICS (continued)

All specifications at  $T_A = T_{MIN}$  to  $T_{MAX}$ ,  $+AV_{DD} = +5$  V,  $-AV_{DD} = -5$  V,  $DV_{DD} = +5$  V (unless otherwise noted).

PARAMETER	TEST CONDITIONS	DAC8581			UNIT
		MIN	TYP	MAX	
<b>POWER SUPPLY</b>					
$+AV_{DD}$		4.0	5	6.0	V
$-AV_{DD}$		-4.0	-5	-6.0	V
$DV_{DD}$		1.8		$AV_{DD}$	V
$I_{DVDD}$			10	20	$\mu$ A
$I_{DD}$	$I_{REF}$ and $IDV_{DD}$ included		17	24	mA
$I_{SS}$			-23	-32	mA
<b>TEMPERATURE RANGE</b>					
Specified performance		-40		+85	$^{\circ}$ C

## PIN CONFIGURATION

PW PACKAGE  
TSSOP-16  
(TOP VIEW)

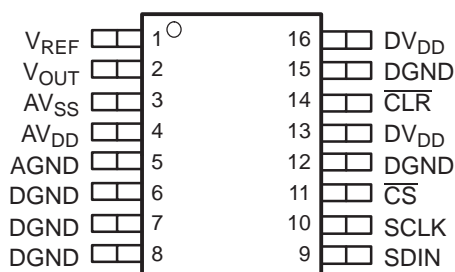

## TERMINAL FUNCTIONS

TERMINAL		
NAME	NO.	
$V_{REF}$	1	Reference input voltage.
VOUT	2	DAC output voltage. Output swing is $\pm V_{REF}$
$AV_{SS}$	3	Negative analog supply voltage, tie to -5 V
$AV_{DD}$	4	Positive analog supply voltage, tie to +5 V
AGND	5	The ground reference point of all analog circuitry of the device. Tie to 0 V.
DGND	6, 7, 8, 15	Tie to DGND to ensure correct operation.
SDIN	9	Digital input, serial data. Ignored when $\overline{CS}$ is high.
SCLK	10	Digital input, serial bit clock. Ignored when $\overline{CS}$ is high.
$\overline{CS}$	11	Digital input. Chip Select ( $\overline{CS}$ ) signal. Active low. When $\overline{CS}$ is high, SCLK and SDI are ignored. When $\overline{CS}$ is low, data can be transferred into the device.
DGND	12	Ground reference for digital circuitry. Tie to 0 V.
$DV_{DD}$	13	Positive digital supply, 1.8 V–5.5 V compatible
$\overline{CLR}$	14	Digital input for forcing the output to midscale. Active low. When pin $\overline{CLR}$ is low during 16 <sup>th</sup> SCLK following the falling edge of $\overline{CS}$ , the falling edge of 16 <sup>th</sup> SCLK sets DAC Latch to midcode, and the DAC output to 0 V. When pin $\overline{CLR}$ is High, the falling edge of 16th SCLK updates DAC latch with the value of input shift register, and changes DAC output to corresponding level.
$DV_{DD}$	16	Tie to $DV_{DD}$ to ensure correct operation.

**TIMING REQUIREMENTS<sup>(1)</sup>**

PARAMETER		MIN	MAX	UNIT
$t_{SCK}$	SCLK period	20		ns
$t_{WSCK}$	SCLK high or low time	10		ns
$t_{Lead}$	Delay from falling $\overline{CS}$ to first rising SCLK	20		ns
$t_{TD}$	$\overline{CS}$ High between two active Periods	20		ns
$t_{SU}$	Data setup time (Input)	5		ns
$t_{HI}$	Data hold time (input)	5		ns
$t_R$	Rise time		30	ns
$t_F$	Fall time		30	ns
$t_{WAIT}$	Delay from 16th falling edge of SCLK to $\overline{CS}$ low	100		ns
$t_{UPDAC}$	Delay from 16th falling edge of SCLK to DAC output	1		$\mu$ s
	$V_{DD}$ High to $\overline{CS}$ Low (power-up delay)	100		$\mu$ s

(1) Assured by design. Not production tested.

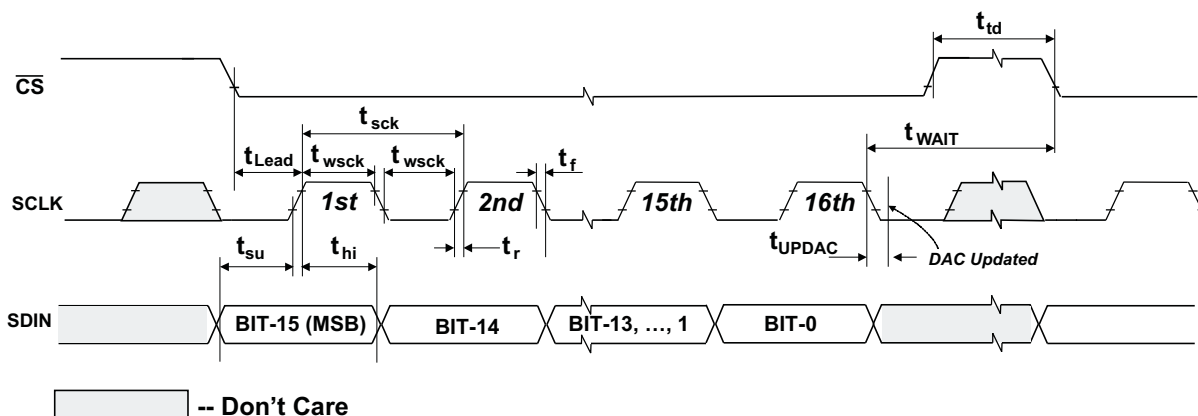

**Figure 1. DAC8581 Timing Diagram**

TYPICAL CHARACTERISTICS

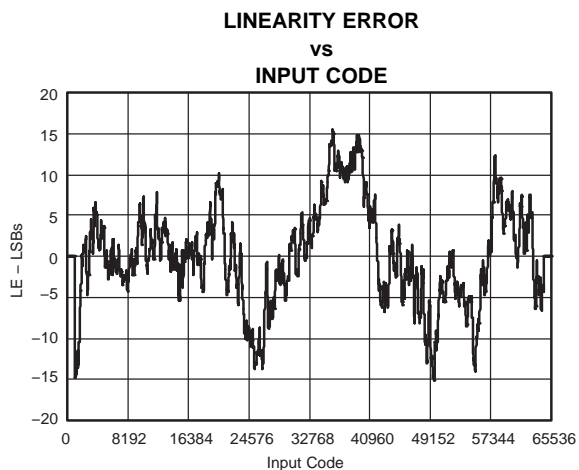

Figure 2.

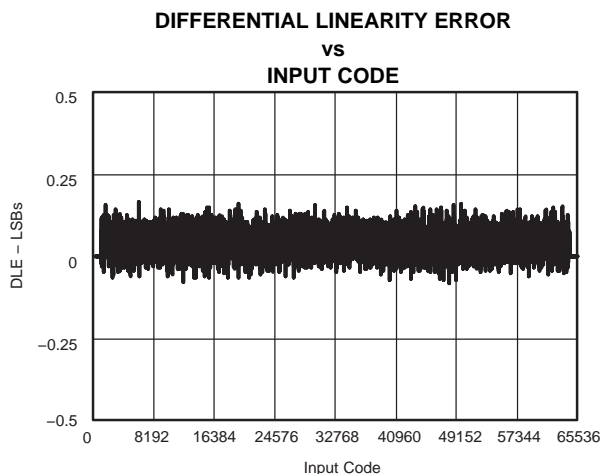

Figure 3.

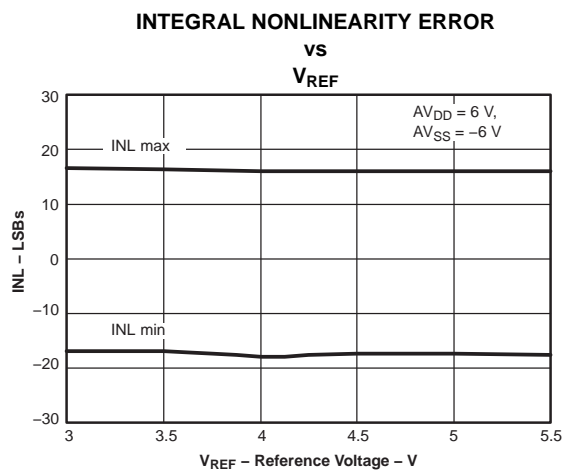

Figure 4.

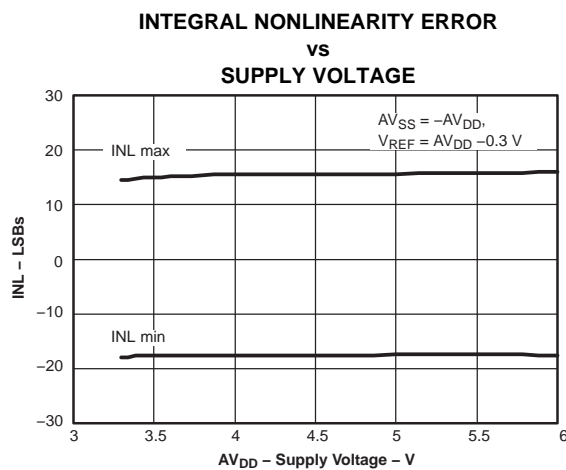

Figure 5.

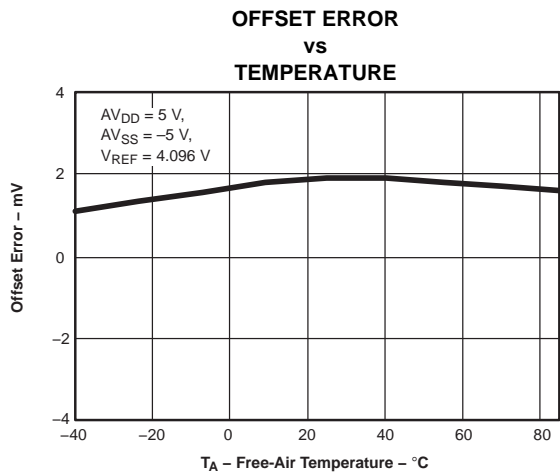

Figure 6.

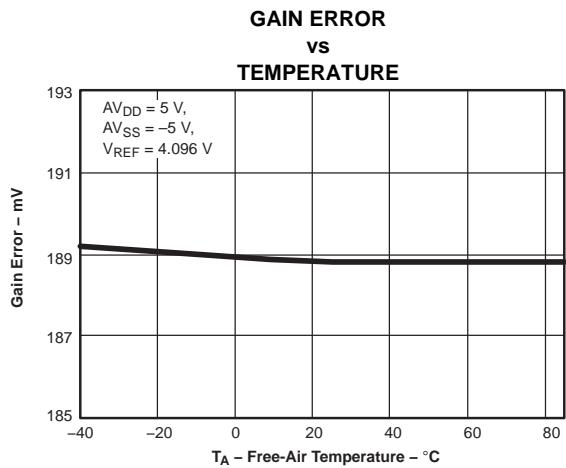

Figure 7.

TYPICAL CHARACTERISTICS (continued)

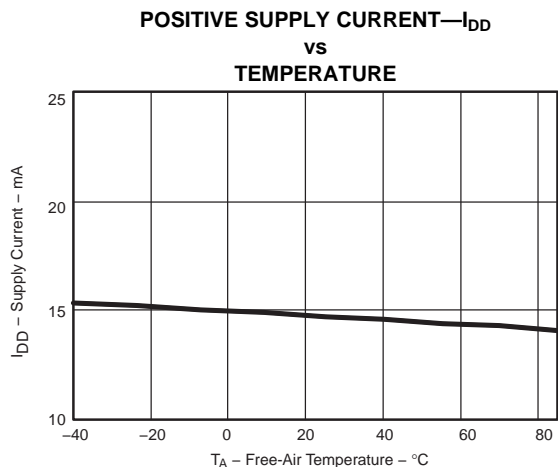

Figure 8.

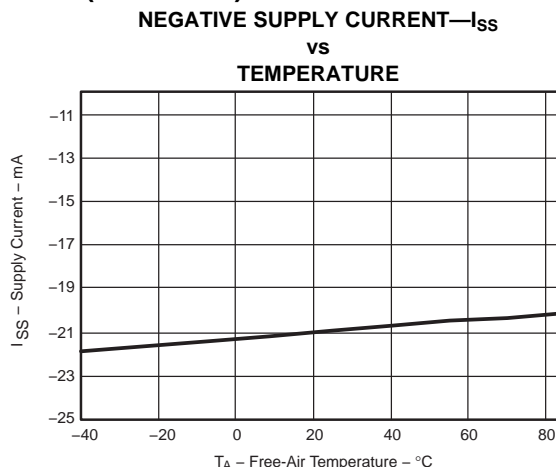

Figure 9.

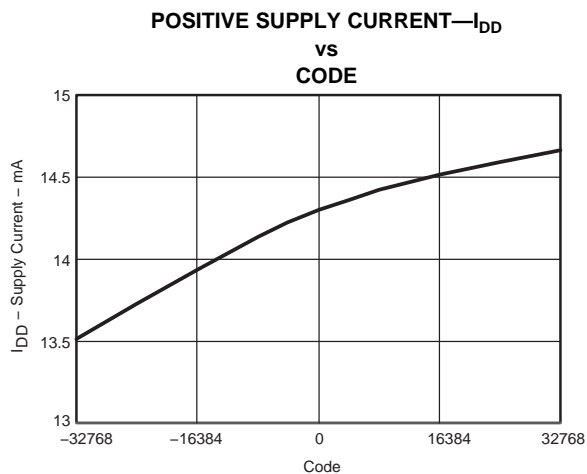

Figure 10.

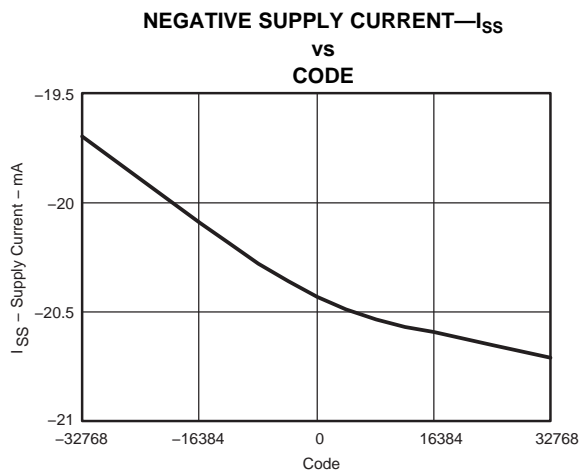

Figure 11.

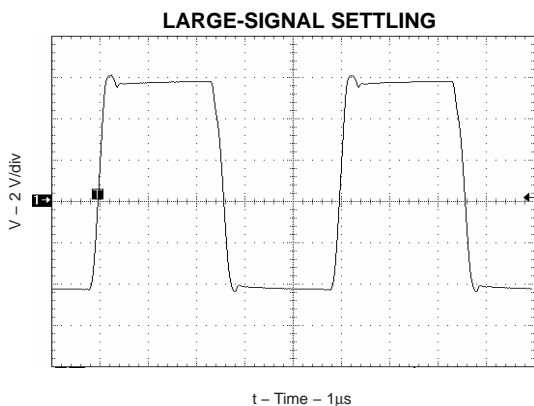

Figure 12.

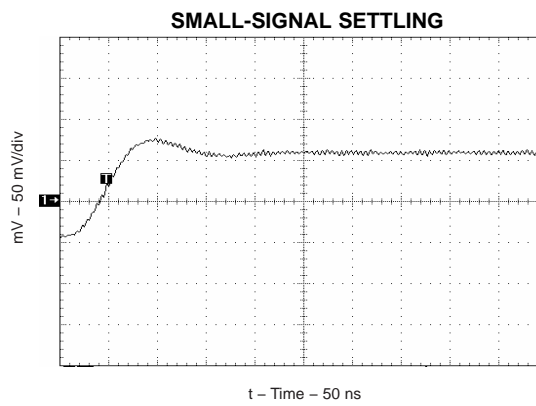

Figure 13.

**TYPICAL CHARACTERISTICS (continued)**

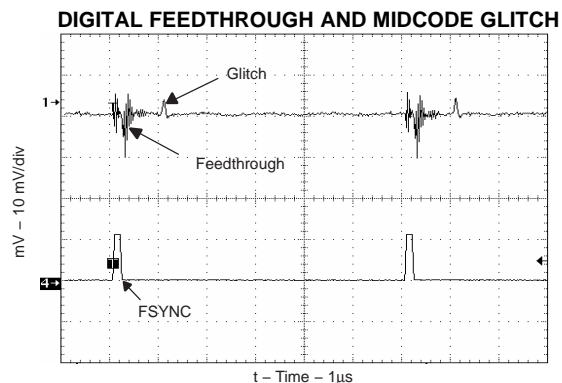

Figure 14.

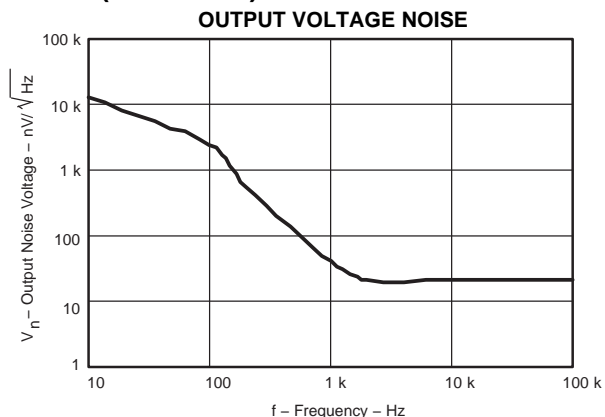

Figure 15.

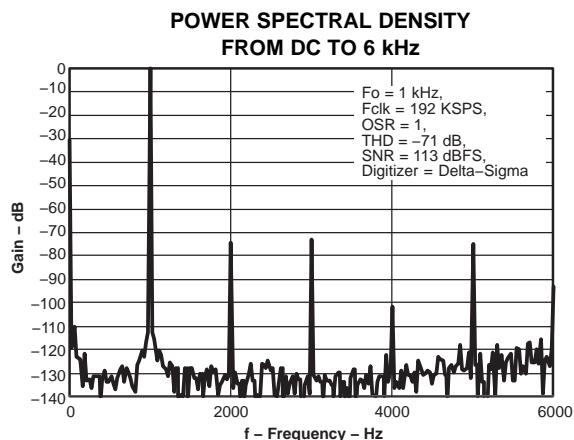

Figure 16.

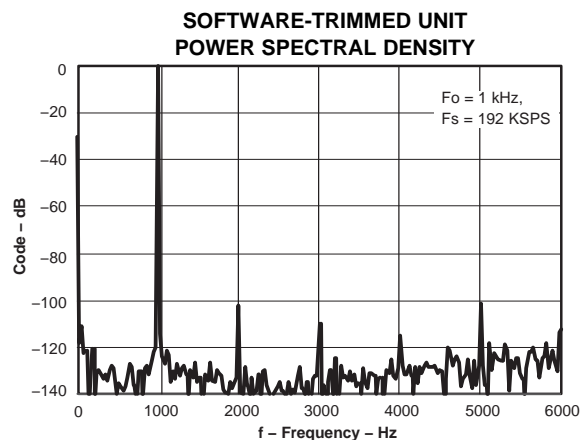

Figure 17.

**SOFTWARE-TRIMMED UNIT  
LINEARITY ERROR  
vs  
INPUT CODE**

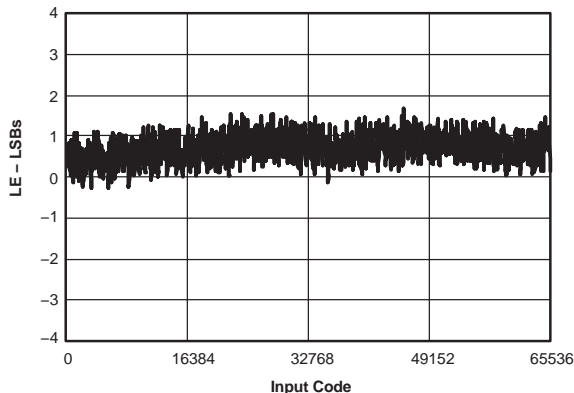

Figure 18.



## THEORY OF OPERATION

The DAC8581 uses a proprietary, monotonic, high-speed resistor string architecture. The 16-bit input data are coded in twos complement, MSB-first format and transmitted using a 3-wire serial interface. The serial interface sends the input data to the DAC latch. The digital data are then decoded to select a tap voltage of the resistor string. The resistor string output is sent to a high-performance output amplifier. The output buffer has bipolar ( $\pm 5$  V) swing capability on a 600- $\Omega$ , 200-pF load. The resistor string DAC architecture provides exceptional differential linearity and temperature stability whereas the output buffer provides fast-settling, low-glitch, and exceptionally low idle-channel noise. The DAC8581 settles within 1  $\mu$ s for large input signals. Exceptionally low glitch (0.5 nV-s) is attainable for small-signal, code-to-code output changes. The resistor string architecture also provides code-independent power consumption and code-independent settling time. The DAC8581 resistor string needs an external reference voltage to set the output voltage range of the DAC. To aid fast settling,  $V_{REF}$  input is internally buffered.

### Supply Pins

The DAC8581 uses  $\pm 5$ -V analog power supplies ( $AV_{DD}$ ,  $AV_{SS}$ ) and a 1.8-V to 5.5-V digital supply ( $DV_{DD}$ ). Analog and digital ground pins (AGND and DGND) are also provided. For low-noise operation, analog and digital power and ground pins should be separated. Sufficient bypass capacitors, at least 1  $\mu$ F, should be placed between  $AV_{DD}$  and  $AV_{SS}$ ,  $AV_{SS}$  and DGND, and  $DV_{DD}$  and DGND pins. Series inductors are *not* recommended on the supply paths. The digital input pins should not exceed the ground potential during power up. During power up, AGND and DGND are first applied with all digital inputs and the reference input kept at 0 V. Then,  $AV_{DD}$ ,  $DV_{DD}$ ,  $AV_{SS}$ , and  $V_{REF}$  should be applied together. Care should be taken to avoid applying  $V_{REF}$  before  $AV_{DD}$  and  $AV_{SS}$ . All digital pins must be kept at ground potential before power up.

### Reference Input Voltage

The reference input pin  $V_{REF}$  is typically tied to a +3.3-V, +4.096-V, or +5.0-V external reference. A bypass capacitor (0.1  $\mu$ F or less) is recommended, depending on the load-driving capability of the voltage reference. To reduce crosstalk and improve settling time, the  $V_{REF}$  pin is internally buffered by a high-performance amplifier. The  $V_{REF}$  pin has constant 5-k $\Omega$  impedance to AGND. The output range of the DAC8581 is equal to  $\pm V_{REF}$  voltage. The  $V_{REF}$  pin should be powered at the same time, or after the supply pins. [REF3133](#) and [REF3140](#) are recommended to set the DAC8581 output range to  $\pm 3.3$  V and  $\pm 4.096$  V, respectively.

### Output Voltage

The input data format is in twos-complement format as shown in [Table 1](#). The DAC8581 uses a high-performance, bipolar output buffer capable of driving a 600- $\Omega$ , 200-pF load with fast 0.65- $\mu$ s settling. The buffer has exceptional noise performance (20 nV/ $\sqrt{\text{Hz}}$ ) and fast slew rate (35 V/ $\mu$ s). The small-signal settling time is under 300 ns, allowing update rates up to 3 MSPS. Loads of 50  $\Omega$  or 75  $\Omega$  could be driven as long as output current does not exceed  $\pm 25$  mA continuously. Long cables, up to 1 nF in capacitance, can be driven without the use of external buffers. To aid stability under large capacitive loads ( $>1$  nF), a small series resistor can be used at the output.

**Table 1. Data Format**

DAC OUTPUT	DIGITAL CODE	
	BINARY	HEX
$+V_{REF}$	0111111111111111	7FFF
$+V_{REF}/2$	0100000000000000	4000
0	0000000000000000	0000
$-V_{REF}/2$	1011111111111111	BFFF
$-V_{REF}$	1000000000000000	8000

Glitch area is low at 0.5 nV-s, with peak glitch amplitude under 10 mV, and the glitch duration under 100 ns. Low glitch is obtained for code-to-code (small signal) changes across the entire transfer function of the device. For large signals, settling characteristics of the reference and output amplifiers are observed in terms of overshoot and undershoot.

Combined with  $\pm 5$ -V output range, and extremely good noise performance, the outstanding differential linearity performance of this device becomes significant. That is, each DAC step can be clearly observed at the DAC output, without being corrupted by wideband noise.

## SERIAL INTERFACE

The DAC8581 serial interface consists of the serial data input pin SDIN, bit clock pin SCLK, and chip-select pin, CS. The serial interface is designed to support the industry standard SPI interface up to 50 MHz. The serial inputs are 1.8-V to 5.5-V logic compatible.

$\overline{\text{CS}}$  operates as an active-low, chip-select signal. The falling edge of  $\overline{\text{CS}}$  initiates the data transfer. Each rising edge of SCLK following the falling edge of  $\overline{\text{CS}}$  shifts the SDIN data into a 16-bit shift register, MSB-first. At the 16th rising edge of SCLK, the shift register becomes full and the DAC data updates on the falling edge that follows the 16th rising edge. After the data update, further clocking gets ignored. The sequence restarts at the next falling edge of  $\overline{\text{CS}}$ . If the  $\overline{\text{CS}}$  is brought high before the DAC data are updated, the data are ignored. See the timing diagram (Figure 1) for details.

### Pin $\overline{\text{CLR}}$

Pin  $\overline{\text{CLR}}$  is implemented to set the DAC output to 0 V. When the  $\overline{\text{CS}}$  pin is low during the 16th SCLK cycle following the falling edge of  $\overline{\text{CS}}$ , the falling edge of the 16th SCLK sets the DAC latch to midcode, and the DAC output to 0 V. If the  $\overline{\text{CLR}}$  pin is high during the 16th clock, the falling edge of the 16th clock updates the DAC latch with the input data. Therefore, if the  $\overline{\text{CLR}}$  pin is brought back to High from Low during serial communication, the DAC output stays at 0 V until the falling edge of the next 16th clock is received. The  $\overline{\text{CLR}}$  pin is active low.  $\overline{\text{CLR}}$  low does not affect the serial data transfer. The serial data input does not get interrupted or lost while the output is set at midscale.

### SCLK

This digital input pin is the serial bit-clock. Data are clocked into the device at the rising edge of SCLK.

### $\overline{\text{CS}}$

This digital input pin is the chip-select signal. When  $\overline{\text{CS}}$  is low, the serial port is enabled and data can be transferred into the device. When  $\overline{\text{CS}}$  is high, all SCLK and SDIN signals are ignored.

### SDIN

This digital input is the serial data input. Serial data are shifted on the rising edge of the SCLK when  $\overline{\text{CS}}$  is low.

## APPLICATION INFORMATION

### IMPROVING DAC8581 LINEARITY USING EXTERNAL CALIBRATION

At output frequencies up to 50 kHz, DAC8581 linearity error and total harmonic distortion are dominated by resistor mismatches in the string. These resistor mismatches are fairly insensitive to temperature and aging effects and also to reference voltage changes. Therefore, it is possible to use a piece-wise linear (PWL) approximation to cancel linearity errors, and the calibration remains effective for different supply and  $V_{REF}$  voltages, etc. The cancellation of linearity errors also improves the total harmonic distortion (THD) performance. It is possible to improve the integral linearity errors from  $\pm 25$  LSB to  $\pm 1$  LSB and the THD from  $-70$  dB to almost  $-98$  dB (see [Figure 17](#) and [Figure 18](#)). The improvements are at the expense of  $\sim 2x$  DNL deterioration, which is not critical for the generation of large-signal waveforms.

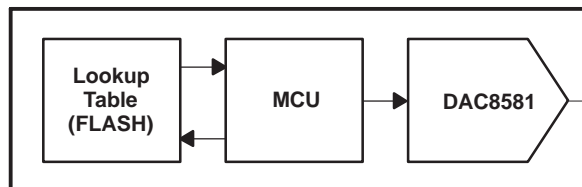

**Figure 19. A Simple Printed-Circuit Board Scheme for Calibrated Use of DAC8581**

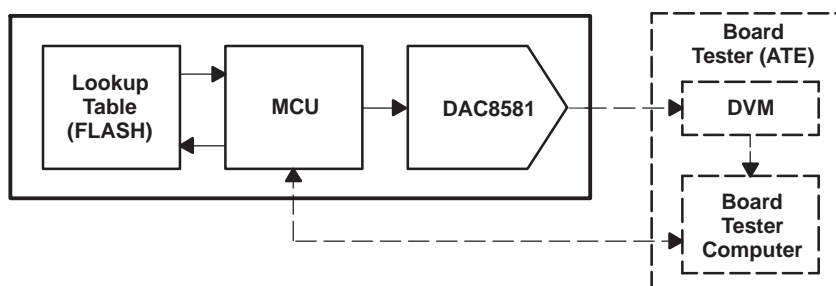

**Figure 20. Production Test Setup for a DAC8581 Board With Calibration**

The PWL calibration scheme uses a DAC8581 and a microcontroller unit (MCU) with flash memory, on a printed-circuit board as seen in [Figure 19](#). Calibration is done during board test, and the calibration coefficients are stored permanently in flash memory as seen in [Figure 20](#). An automated board tester is assumed to have a precision digital voltmeter (DVM) and a tester computer. The test flow for a 1024-segment, piece-wise linear calibration is as follows:

1. Use the tester computer to load software into the MCU to ramp the DAC8581 and:
  - Take a reading at each step after a short wait time
  - Store 65,536 readings in the tester computer volatile memory
2. Use the tester computer to:
  - Search the 65,536-point capture data and find the actual DAC8581 codes which would generate ideal DAC outputs for DAC input codes 0, 64, 128, 192, ... .
  - Store these actual codes in the onboard microcontroller's flash memory in a 1025-point array called COEFF[].
3. Use the tester computer to program the MCU such that, when the end-user provides new 16-bit input data D0 to the MCU:
  - The 10 MSBs of D0 directly index the array COEFF[].
  - The content of indexed memory of COEFF[] and the content of the next higher memory location are placed in variables I1 and I2.
  - The six LSBs of the user data D0 with two variables I1 and I2 are used for computing [Equation 1](#) (see [Figure 21](#)).
  - Instead of D0, I0 is loaded to DAC8581

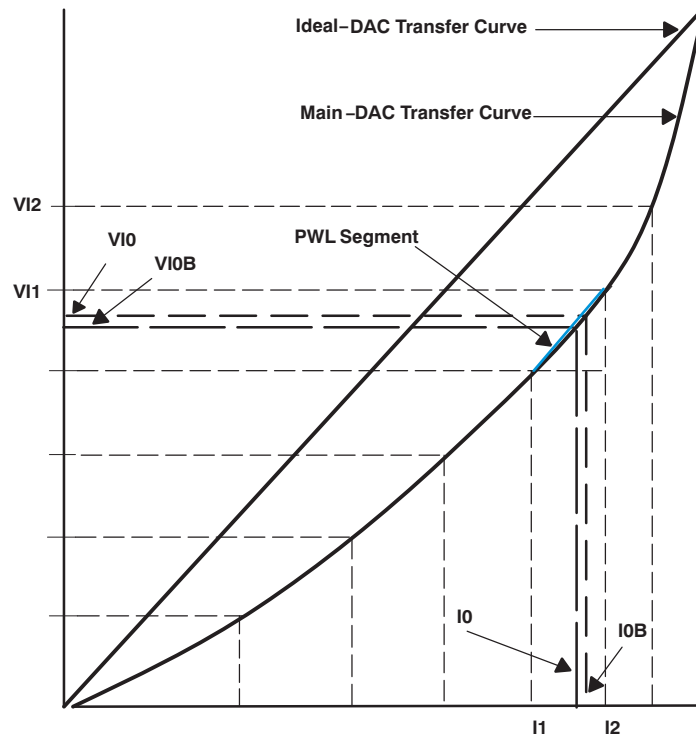

**Figure 21. The Geometry Behind the PWL Calibration**

$$I_0 = \frac{I_1 + (I_2 - I_1)(D_0 - VI_1)}{VI_2 - VI_1} \quad (1)$$

Where both x-axis and y-axis are normalized from 0 to 65535, and:

VI0: Desired ideal DAC voltage corresponding to input code D0.

VI0B: DAC8581 output voltage, which approximates VI0 after PWL calibration. This is the actual DAC8581 output for input code D0 after PWL calibration.

I0: DAC8581 code generating VI0B, an approximation to the desired voltage VI0. This is actual code loaded into DAC latch for input code D0, after PWL calibration.

I0B: DAC8581 code, which generates output VI0. This code is approximated by the N-segment PWL calibration.

I1: Contents of memory COEFF[], addressed by the 10 MSBs of user input code D0.

I2: Contents of the next memory location in COEFF[].

VI1: DAC8581 output voltage corresponding to code I1. Notice that (D0–VI1) is nothing but the six LSBs of the input code D0, given that the y-axis is normalized from 0 to 65,536.

VI2: DAC8581 output voltage corresponding to code I2. Notice that (VI2–VI1) is always equal to number 64, given that the y-axis is normalized from 0 to 65,536. Division becomes a 6-bit arithmetic right shift.

Other similar PWL calibration implementations exist. This particular algorithm does not need digital division, and it does not accumulate measurement errors at each segment.

## REVISION HISTORY

NOTE: Page numbers for previous revisions may differ from page numbers in the current version.

<b>Changes from Revision A (August, 2005) to Revision B</b>	<b>Page</b>
• Updated document format to current stylistic standards .....	1
• Deleted lead temperature specifications from <i>Absolute Maximum Ratings</i> table .....	2
• Deleted footnote 1 from <i>Electrical Characteristics</i> table .....	3
• Revised test conditions for voltage output specification .....	3
<b>Changes from Revision B (December 2009) to Revision C</b>	<b>Page</b>
• Changed "rail-to-rail" to "bipolar" .....	1
• Changed "rail-to-rail" to "bipolar" .....	9

## PACKAGING INFORMATION

Orderable Device	Status (1)	Package Type	Package Drawing	Pins	Package Qty	Eco Plan (2)	Lead/Ball Finish (6)	MSL Peak Temp (3)	Op Temp (°C)	Device Marking (4/5)	Samples
DAC8581IPW	NRND	TSSOP	PW	16	90	Green (RoHS & no Sb/Br)	CU NIPDAU	Level-1-260C-UNLIM	-40 to 85	D8581I	
DAC8581IPWG4	NRND	TSSOP	PW	16	90	Green (RoHS & no Sb/Br)	CU NIPDAU	Level-1-260C-UNLIM	-40 to 85	D8581I	
DAC8581IPWR	NRND	TSSOP	PW	16	2000	Green (RoHS & no Sb/Br)	CU NIPDAU	Level-1-260C-UNLIM	-40 to 85	D8581I	
DAC8581IPWRG4	NRND	TSSOP	PW	16	2000	Green (RoHS & no Sb/Br)	CU NIPDAU	Level-1-260C-UNLIM	-40 to 85	D8581I	

(1) The marketing status values are defined as follows:

**ACTIVE:** Product device recommended for new designs.

**LIFEBUY:** TI has announced that the device will be discontinued, and a lifetime-buy period is in effect.

**NRND:** Not recommended for new designs. Device is in production to support existing customers, but TI does not recommend using this part in a new design.

**PREVIEW:** Device has been announced but is not in production. Samples may or may not be available.

**OBSOLETE:** TI has discontinued the production of the device.

(2) Eco Plan - The planned eco-friendly classification: Pb-Free (RoHS), Pb-Free (RoHS Exempt), or Green (RoHS & no Sb/Br) - please check <http://www.ti.com/productcontent> for the latest availability information and additional product content details.

**TBD:** The Pb-Free/Green conversion plan has not been defined.

**Pb-Free (RoHS):** TI's terms "Lead-Free" or "Pb-Free" mean semiconductor products that are compatible with the current RoHS requirements for all 6 substances, including the requirement that lead not exceed 0.1% by weight in homogeneous materials. Where designed to be soldered at high temperatures, TI Pb-Free products are suitable for use in specified lead-free processes.

**Pb-Free (RoHS Exempt):** This component has a RoHS exemption for either 1) lead-based flip-chip solder bumps used between the die and package, or 2) lead-based die adhesive used between the die and leadframe. The component is otherwise considered Pb-Free (RoHS compatible) as defined above.

**Green (RoHS & no Sb/Br):** TI defines "Green" to mean Pb-Free (RoHS compatible), and free of Bromine (Br) and Antimony (Sb) based flame retardants (Br or Sb do not exceed 0.1% by weight in homogeneous material)

(3) MSL, Peak Temp. - The Moisture Sensitivity Level rating according to the JEDEC industry standard classifications, and peak solder temperature.

(4) There may be additional marking, which relates to the logo, the lot trace code information, or the environmental category on the device.

(5) Multiple Device Markings will be inside parentheses. Only one Device Marking contained in parentheses and separated by a "~" will appear on a device. If a line is indented then it is a continuation of the previous line and the two combined represent the entire Device Marking for that device.

(6) Lead/Ball Finish - Orderable Devices may have multiple material finish options. Finish options are separated by a vertical ruled line. Lead/Ball Finish values may wrap to two lines if the finish value exceeds the maximum column width.

**Important Information and Disclaimer:** The information provided on this page represents TI's knowledge and belief as of the date that it is provided. TI bases its knowledge and belief on information provided by third parties, and makes no representation or warranty as to the accuracy of such information. Efforts are underway to better integrate information from third parties. TI has taken and continues to take reasonable steps to provide representative and accurate information but may not have conducted destructive testing or chemical analysis on incoming materials and chemicals. TI and TI suppliers consider certain information to be proprietary, and thus CAS numbers and other limited information may not be available for release.

In no event shall TI's liability arising out of such information exceed the total purchase price of the TI part(s) at issue in this document sold by TI to Customer on an annual basis.

**TAPE AND REEL INFORMATION**

**QUADRANT ASSIGNMENTS FOR PIN 1 ORIENTATION IN TAPE**

\*All dimensions are nominal

Device	Package Type	Package Drawing	Pins	SPQ	Reel Diameter (mm)	Reel Width W1 (mm)	A0 (mm)	B0 (mm)	K0 (mm)	P1 (mm)	W (mm)	Pin1 Quadrant
DAC8581IPWR	TSSOP	PW	16	2000	330.0	12.4	6.9	5.6	1.6	8.0	12.0	Q1



**TAPE AND REEL BOX DIMENSIONS**

\*All dimensions are nominal

Device	Package Type	Package Drawing	Pins	SPQ	Length (mm)	Width (mm)	Height (mm)
DAC8581PWR	TSSOP	PW	16	2000	367.0	367.0	38.0

PW (R-PDSO-G16)

PLASTIC SMALL OUTLINE



4040064-4/G 02/11

- NOTES:
- A. All linear dimensions are in millimeters. Dimensioning and tolerancing per ASME Y14.5M-1994.
  - B. This drawing is subject to change without notice.
  - C. Body length does not include mold flash, protrusions, or gate burrs. Mold flash, protrusions, or gate burrs shall not exceed 0,15 each side.
  - D. Body width does not include interlead flash. Interlead flash shall not exceed 0,25 each side.
  - E. Falls within JEDEC MO-153

PW (R-PDSO-G16)

PLASTIC SMALL OUTLINE



- NOTES:
- All linear dimensions are in millimeters.
  - This drawing is subject to change without notice.
  - Publication IPC-7351 is recommended for alternate designs.
  - Laser cutting apertures with trapezoidal walls and also rounding corners will offer better paste release. Customers should contact their board assembly site for stencil design recommendations. Refer to IPC-7525 for other stencil recommendations.
  - Customers should contact their board fabrication site for solder mask tolerances between and around signal pads.

## IMPORTANT NOTICE

Texas Instruments Incorporated and its subsidiaries (TI) reserve the right to make corrections, enhancements, improvements and other changes to its semiconductor products and services per JESD46, latest issue, and to discontinue any product or service per JESD48, latest issue. Buyers should obtain the latest relevant information before placing orders and should verify that such information is current and complete. All semiconductor products (also referred to herein as "components") are sold subject to TI's terms and conditions of sale supplied at the time of order acknowledgment.

TI warrants performance of its components to the specifications applicable at the time of sale, in accordance with the warranty in TI's terms and conditions of sale of semiconductor products. Testing and other quality control techniques are used to the extent TI deems necessary to support this warranty. Except where mandated by applicable law, testing of all parameters of each component is not necessarily performed.

TI assumes no liability for applications assistance or the design of Buyers' products. Buyers are responsible for their products and applications using TI components. To minimize the risks associated with Buyers' products and applications, Buyers should provide adequate design and operating safeguards.

TI does not warrant or represent that any license, either express or implied, is granted under any patent right, copyright, mask work right, or other intellectual property right relating to any combination, machine, or process in which TI components or services are used. Information published by TI regarding third-party products or services does not constitute a license to use such products or services or a warranty or endorsement thereof. Use of such information may require a license from a third party under the patents or other intellectual property of the third party, or a license from TI under the patents or other intellectual property of TI.

Reproduction of significant portions of TI information in TI data books or data sheets is permissible only if reproduction is without alteration and is accompanied by all associated warranties, conditions, limitations, and notices. TI is not responsible or liable for such altered documentation. Information of third parties may be subject to additional restrictions.

Resale of TI components or services with statements different from or beyond the parameters stated by TI for that component or service voids all express and any implied warranties for the associated TI component or service and is an unfair and deceptive business practice. TI is not responsible or liable for any such statements.

Buyer acknowledges and agrees that it is solely responsible for compliance with all legal, regulatory and safety-related requirements concerning its products, and any use of TI components in its applications, notwithstanding any applications-related information or support that may be provided by TI. Buyer represents and agrees that it has all the necessary expertise to create and implement safeguards which anticipate dangerous consequences of failures, monitor failures and their consequences, lessen the likelihood of failures that might cause harm and take appropriate remedial actions. Buyer will fully indemnify TI and its representatives against any damages arising out of the use of any TI components in safety-critical applications.

In some cases, TI components may be promoted specifically to facilitate safety-related applications. With such components, TI's goal is to help enable customers to design and create their own end-product solutions that meet applicable functional safety standards and requirements. Nonetheless, such components are subject to these terms.

No TI components are authorized for use in FDA Class III (or similar life-critical medical equipment) unless authorized officers of the parties have executed a special agreement specifically governing such use.

Only those TI components which TI has specifically designated as military grade or "enhanced plastic" are designed and intended for use in military/aerospace applications or environments. Buyer acknowledges and agrees that any military or aerospace use of TI components which have **not** been so designated is solely at the Buyer's risk, and that Buyer is solely responsible for compliance with all legal and regulatory requirements in connection with such use.

TI has specifically designated certain components as meeting ISO/TS16949 requirements, mainly for automotive use. In any case of use of non-designated products, TI will not be responsible for any failure to meet ISO/TS16949.

### Products

Audio	<a href="http://www.ti.com/audio">www.ti.com/audio</a>
Amplifiers	<a href="http://amplifier.ti.com">amplifier.ti.com</a>
Data Converters	<a href="http://dataconverter.ti.com">dataconverter.ti.com</a>
DLP® Products	<a href="http://www.dlp.com">www.dlp.com</a>
DSP	<a href="http://dsp.ti.com">dsp.ti.com</a>
Clocks and Timers	<a href="http://www.ti.com/clocks">www.ti.com/clocks</a>
Interface	<a href="http://interface.ti.com">interface.ti.com</a>
Logic	<a href="http://logic.ti.com">logic.ti.com</a>
Power Mgmt	<a href="http://power.ti.com">power.ti.com</a>
Microcontrollers	<a href="http://microcontroller.ti.com">microcontroller.ti.com</a>
RFID	<a href="http://www.ti-rfid.com">www.ti-rfid.com</a>
OMAP Applications Processors	<a href="http://www.ti.com/omap">www.ti.com/omap</a>
Wireless Connectivity	<a href="http://www.ti.com/wirelessconnectivity">www.ti.com/wirelessconnectivity</a>

### Applications

Automotive and Transportation	<a href="http://www.ti.com/automotive">www.ti.com/automotive</a>
Communications and Telecom	<a href="http://www.ti.com/communications">www.ti.com/communications</a>
Computers and Peripherals	<a href="http://www.ti.com/computers">www.ti.com/computers</a>
Consumer Electronics	<a href="http://www.ti.com/consumer-apps">www.ti.com/consumer-apps</a>
Energy and Lighting	<a href="http://www.ti.com/energy">www.ti.com/energy</a>
Industrial	<a href="http://www.ti.com/industrial">www.ti.com/industrial</a>
Medical	<a href="http://www.ti.com/medical">www.ti.com/medical</a>
Security	<a href="http://www.ti.com/security">www.ti.com/security</a>
Space, Avionics and Defense	<a href="http://www.ti.com/space-avionics-defense">www.ti.com/space-avionics-defense</a>
Video and Imaging	<a href="http://www.ti.com/video">www.ti.com/video</a>

### TI E2E Community

[e2e.ti.com](http://e2e.ti.com)