

CSD88599Q5DC 60-V Half-Bridge NexFET™ Power Block

1 Features

- Half-Bridge Power Block
- High-Density SON 5-mm x 6-mm Footprint
- Low $R_{DS(ON)}$ for Minimized Conduction Losses
 - 3.0-W P_{Loss} at 30 A
- DualCool™ Thermally Enhanced Package
- Ultra-Low-Inductance Package
- RoHS Compliant
- Halogen Free
- Lead-Free Terminal Plating

2 Applications

- Three-Phase Bridge for Brushless DC Motor Control
- Up to 12s Battery Power Tools
- Other Half and Full Bridge Topologies

3 Description

The CSD88599Q5DC 60-V power block is an optimized design for high-current motor control applications, such as handheld, cordless garden and power tools. This device utilizes TI's stacked die technology in order to minimize parasitic inductances while offering a complete half bridge in a space saving thermally enhanced DualCool™ 5-mm x 6-mm package. With an exposed metal top, this power block device allows for simple heat sink application to draw heat out through the top of the package and away from the PCB, for superior thermal performance at the higher currents demanded by many motor control applications.

Power Block Schematic

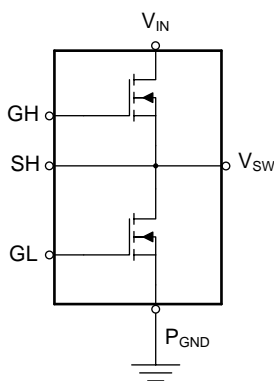

Copyright © 2017, Texas Instruments Incorporated

Bottom View

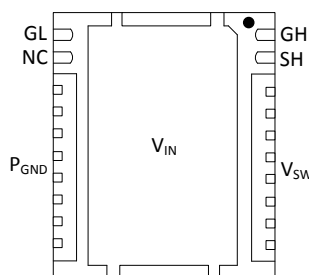

Top View

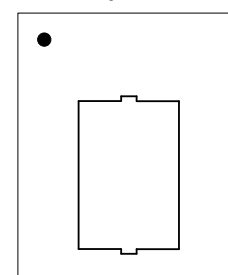

Device Information

DEVICE	QTY	MEDIA	PACKAGE	SHIP
CSD88599Q5DC	2500	13-Inch Reel	SON	Tape and Reel
CSD88599Q5DCT	250	7-Inch Reel	5.00-mm x 6.00-mm Plastic Package	

Typical Circuit

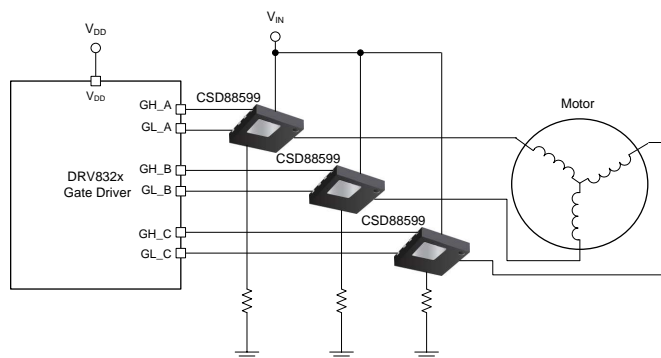

Copyright © 2017, Texas Instruments Incorporated

Power Loss vs Output Current

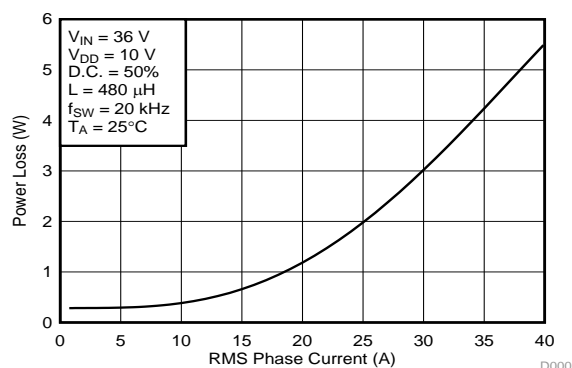

Table of Contents

1 Features	1	6.6 Design Example – Regulate Current to Maintain Safe Operation	13
2 Applications	1	6.7 Design Example – Regulate Board and Case Temperature to Maintain Safe Operation	14
3 Description	1	7 Layout	15
4 Revision History	2	7.1 Layout Guidelines	15
5 Specifications	3	7.2 Layout Example	16
5.1 Absolute Maximum Ratings	3	8 Device and Documentation Support	18
5.2 Recommended Operating Conditions.....	3	8.1 Receiving Notification of Documentation Updates..	18
5.3 Power Block Performance	3	8.2 Community Resources.....	18
5.4 Thermal Information	4	8.3 Trademarks	18
5.5 Electrical Characteristics.....	4	8.4 Electrostatic Discharge Caution.....	18
5.6 Typical Power Block Device Characteristics.....	6	8.5 Glossary	18
5.7 Typical Power Block MOSFET Characteristics.....	7	9 Mechanical, Packaging, and Orderable Information	19
6 Application and Implementation	9	9.1 Q5DC Package Dimensions	19
6.1 Application Information.....	9	9.2 Land Pattern Recommendation	20
6.2 Brushless DC Motor With Trapezoidal Control	10	9.3 Stencil Recommendation	21
6.3 Power Loss Curves	12		
6.4 Safe Operating Area (SOA) Curve.....	13		
6.5 Normalized Power Loss Curves.....	13		

4 Revision History

DATE	REVISION	NOTES
April 2017	*	Initial release.

5 Specifications

5.1 Absolute Maximum Ratings⁽¹⁾

 $T_J = 25^\circ\text{C}$ (unless otherwise noted)

PARAMETER	CONDITIONS	MIN	MAX	UNIT
Voltage	V_{IN} to P_{GND}	-0.8	60	V
	V_{SW} to P_{GND}	-0.3	60	
	GH to SH	-20	20	
	GL to P_{GND}	-20	20	
Pulsed current rating, $I_{DM}^{(2)}$			400	A
Power dissipation, P_D			12	W
Avalanche energy, E_{AS}	High-side FET, $I_D = 95\text{ A}$, $L = 0.1\text{ mH}$		448	mJ
	Low-side FET, $I_D = 95\text{ A}$, $L = 0.1\text{ mH}$		448	
Operating junction temperature, T_J		-55	150	$^\circ\text{C}$
Storage temperature, T_{stg}		-55	150	$^\circ\text{C}$

- (1) Stresses beyond those listed under *Absolute Maximum Ratings* may cause permanent damage to the device. These are stress ratings only, and functional operation of the device at these or any other conditions beyond those indicated in the *Recommended Operating Conditions* is not implied. Exposure to absolute-maximum-rated conditions for extended periods may affect device reliability.
- (2) Single FET conduction, max $R_{\theta JC} = 1.1^\circ\text{C/W}$, pulse duration $\leq 100\ \mu\text{s}$, single pulse.

5.2 Recommended Operating Conditions

 $T_J = 25^\circ\text{C}$ (unless otherwise noted)

PARAMETER	CONDITIONS	MIN	MAX	UNIT
V_{DD} Gate drive voltage		4.5	16	V
V_{IN} Input supply voltage ⁽¹⁾			54	V
f_{SW} Switching frequency	$C_{BST} = 0.1\ \mu\text{F}$ (min)	5	50	kHz
I_{OUT} RMS motor winding current			40	A
T_J Operating temperature			125	$^\circ\text{C}$

- (1) Up to 42-V input use one capacitor per phase, MLCC 10 nF, 100 V, X7S, 0402, PN: C1005X7S2A103K050BB from V_{IN} to GND return. Between 42-V to 54-V input operation, add RC switch-node snubber as described in the [Electrical Performance](#) section of this data sheet.

5.3 Power Block Performance

 $T_J = 25^\circ\text{C}$ (unless otherwise noted)

PARAMETER	CONDITIONS	MIN	TYP	MAX	UNIT
P_{LOSS} Power loss ⁽¹⁾	$V_{IN} = 36\text{ V}$, $V_{DD} = 10\text{ V}$, $I_{OUT} = 30\text{ A}$, $f_{SW} = 20\text{ kHz}$, $T_J = 25^\circ\text{C}$, duty cycle = 50%, $L = 480\ \mu\text{H}$		3.0		W
P_{LOSS} Power loss	$V_{IN} = 36\text{ V}$, $V_{DD} = 10\text{ V}$, $I_{OUT} = 30\text{ A}$, $f_{SW} = 20\text{ kHz}$, $T_J = 125^\circ\text{C}$, duty cycle = 50%, $L = 480\ \mu\text{H}$		3.4		W

- (1) Measurement made with eight 10- μF 50-V $\pm 10\%$ X5R (TDK C3225X5R1H106K250AB or equivalent) ceramic capacitors placed across V_{IN} to P_{GND} pins and using UCC27210DDAR 100-V, 4-A driver IC.

5.4 Thermal Information

 $T_J = 25^\circ\text{C}$ (unless otherwise stated)

THERMAL METRIC		MIN	TYP	MAX	UNIT
$R_{\theta JA}$	Junction-to-ambient thermal resistance (min Cu) ⁽¹⁾			125	°C/W
	Junction-to-ambient thermal resistance (max Cu) ⁽¹⁾⁽²⁾			50	
$R_{\theta JC}$	Junction-to-case thermal resistance (top of package) ⁽¹⁾			2.1	°C/W
	Junction-to-case thermal resistance (V_{IN} pin) ⁽¹⁾			1.1	

(1) $R_{\theta JC}$ is determined with the device mounted on a 1-in² (6.45-cm²), 2-oz (0.071-mm) thick Cu pad on a 1.5-in × 1.5-in (3.81-cm × 3.81-cm), 0.06-in (1.52-mm) thick FR4 board. $R_{\theta JC}$ is specified by design while $R_{\theta JA}$ is determined by the user's board design.

(2) Device mounted on FR4 material with 1-in² (6.45-cm²) Cu.

5.5 Electrical Characteristics

 $T_J = 25^\circ\text{C}$ (unless otherwise stated)

PARAMETER		TEST CONDITIONS	MIN	TYP	MAX	UNIT
STATIC CHARACTERISTICS						
BV_{DSS}	Drain-to-source voltage	$V_{GS} = 0\text{ V}, I_{DS} = 250\ \mu\text{A}$	60			V
I_{DSS}	Drain-to-source leakage current	$V_{GS} = 0\text{ V}, V_{DS} = 48\text{ V}$			1	μA
I_{GSS}	Gate-to-source leakage current	$V_{DS} = 0\text{ V}, V_{GS} = 20\text{ V}$			100	nA
$V_{GS(th)}$	Gate-to-source threshold voltage	$V_{DS} = V_{GS}, I_{DS} = 250\ \mu\text{A}$	1.4	2.0	2.5	V
$R_{DS(on)}$	Drain-to-source on resistance	$V_{GS} = 4.5\text{ V}, I_{DS} = 30\text{ A}$		2.5	3.3	mΩ
		$V_{GS} = 10\text{ V}, I_{DS} = 30\text{ A}$		1.7	2.1	
g_{fs}	Transconductance	$V_{DS} = 6\text{ V}, I_{DS} = 30\text{ A}$		130		S
DYNAMIC CHARACTERISTICS						
C_{ISS}	Input capacitance	$V_{GS} = 0\text{ V}, V_{DS} = 30\text{ V}, f = 1\text{ MHz}$		3720	4840	pF
C_{OSS}	Output capacitance			670	870	pF
C_{RSS}	Reverse transfer capacitance			12	16	pF
R_G	Series gate resistance			0.9	1.8	Ω
Q_g	Gate charge total (4.5 V)	$V_{DS} = 30\text{ V}, I_{DS} = 30\text{ A}$		21	27	nC
Q_g	Gate charge total (10 V)			43	56	nC
Q_{gd}	Gate charge gate-to-drain			7.0		nC
Q_{gs}	Gate charge gate-to-source			10.1		nC
$Q_{g(th)}$	Gate charge at V_{th}			6.3		nC
Q_{OSS}	Output charge	$V_{DS} = 30\text{ V}, V_{GS} = 0\text{ V}$		100		nC
$t_{d(on)}$	Turnon delay time	$V_{DS} = 30\text{ V}, V_{GS} = 10\text{ V}, I_{DS} = 30\text{ A}, R_G = 0\ \Omega$		9		ns
t_r	Rise time			20		ns
$t_{d(off)}$	Turnoff delay time			23		ns
t_f	Fall time			3		ns
DIODE CHARACTERISTICS						
V_{SD}	Diode forward voltage	$I_{DS} = 30\text{ A}, V_{GS} = 0\text{ V}$		0.8	1.0	V
Q_{rr}	Reverse recovery charge	$V_{DS} = 30\text{ V}, I_F = 30\text{ A}, di/dt = 300\text{ A}/\mu\text{s}$		172		nC
t_{rr}	Reverse recovery time			36		ns

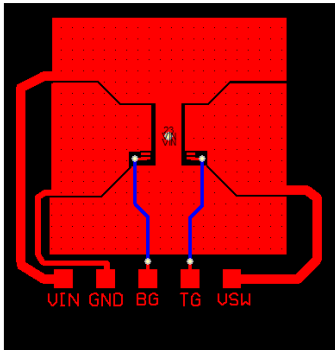

Max $R_{\theta JA} = 50^{\circ}\text{C/W}$
when mounted on 1 in²
(6.45 cm²) of 2-oz
(0.071-mm) thick Cu.

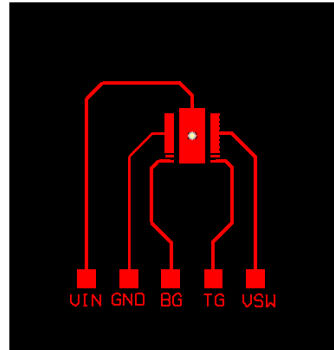

Max $R_{\theta JA} = 125^{\circ}\text{C/W}$
when mounted on
minimum pad area of
2-oz (0.071-mm) thick
Cu.

5.6 Typical Power Block Device Characteristics

The typical power block system characteristic curves (Figure 1 through Figure 6) are based on measurements made on a PCB design with dimensions of 4 in (W) × 3.5 in (L) × 0.062 in (H) and 6 copper layers of 1-oz copper thickness. See [Application and Implementation](#) section for detailed explanation. $T_J = 125^\circ\text{C}$, unless stated otherwise.

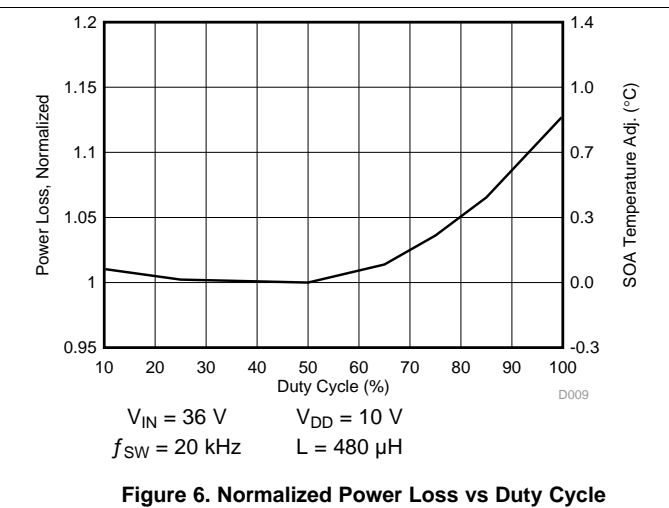
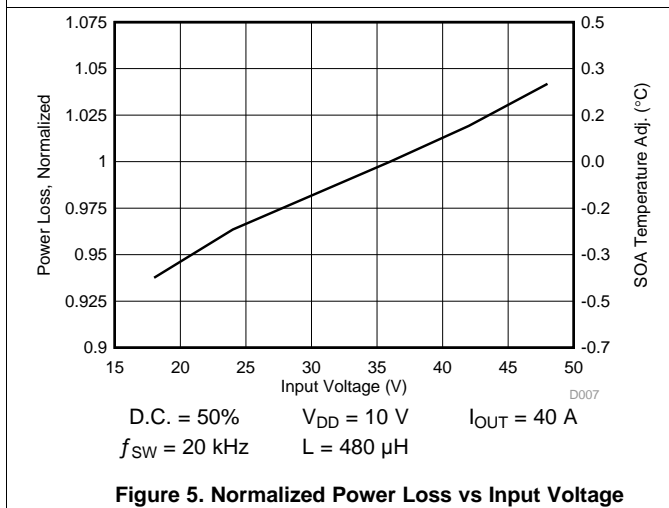
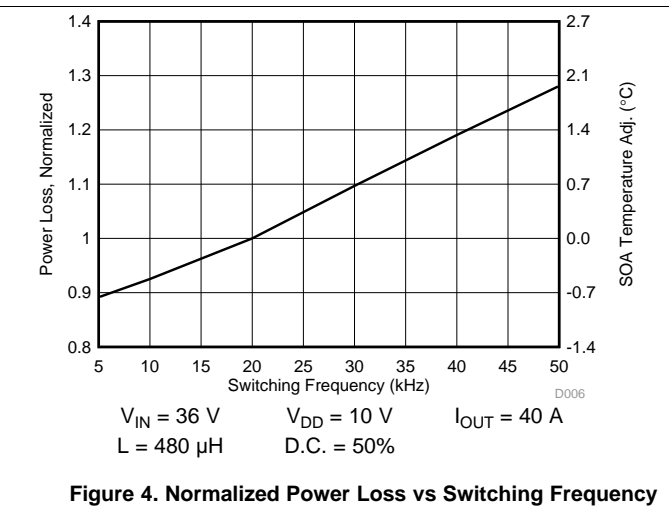
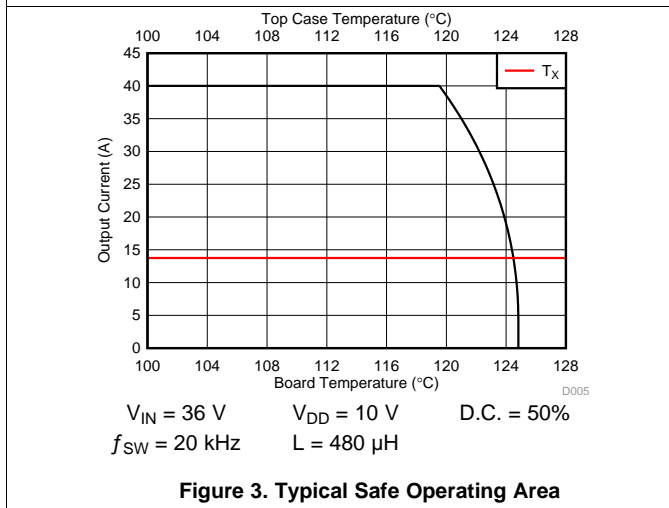
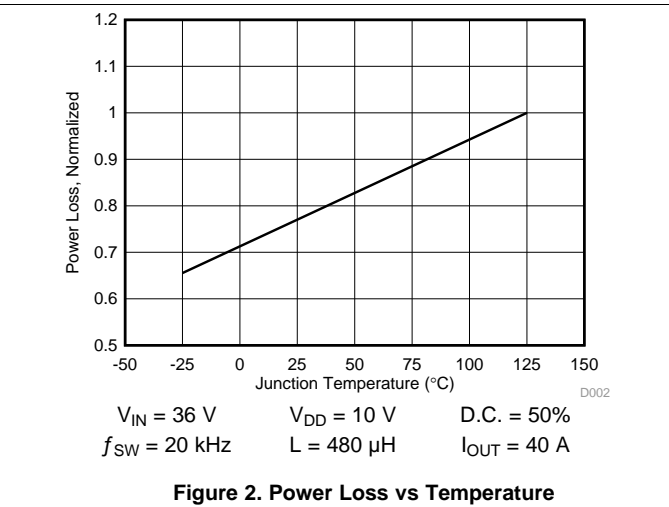
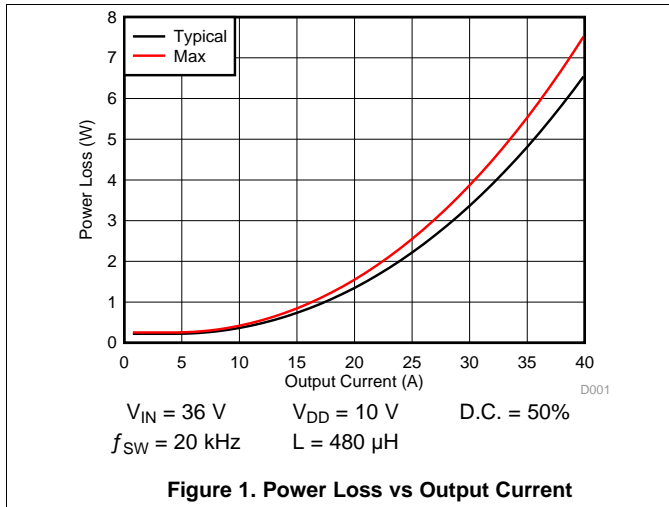

5.7 Typical Power Block MOSFET Characteristics

T_J = 25°C, unless stated otherwise.

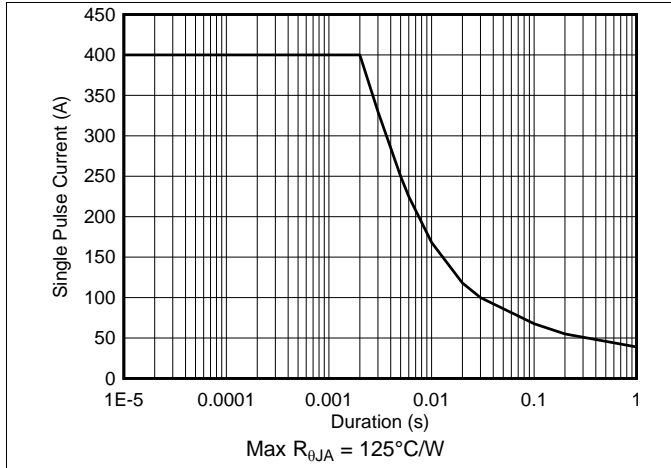

Figure 7. Single Pulse Current vs Pulse Duration

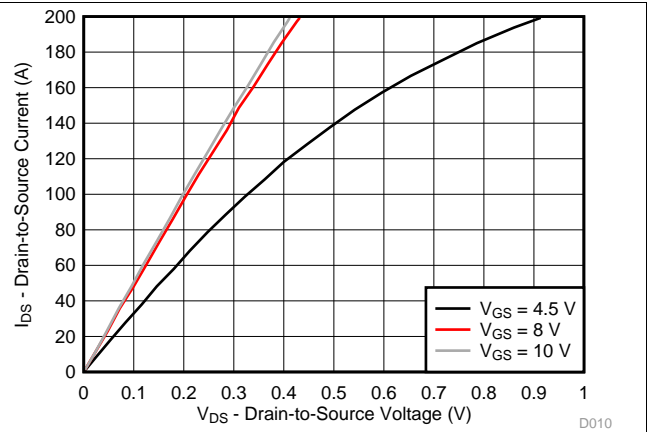

Figure 8. MOSFET Saturation Characteristics

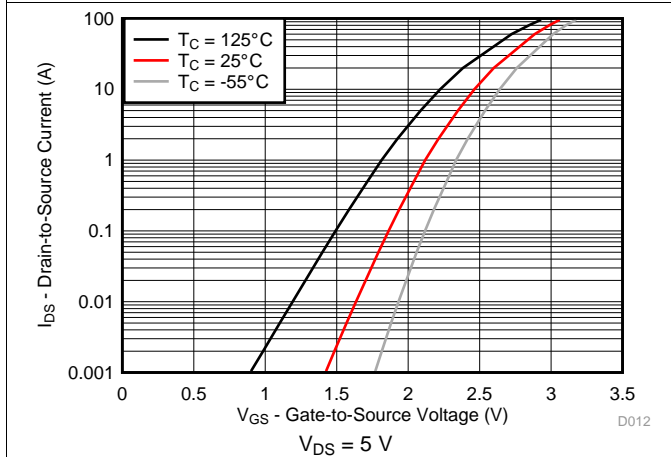

Figure 9. MOSFET Transfer Characteristics

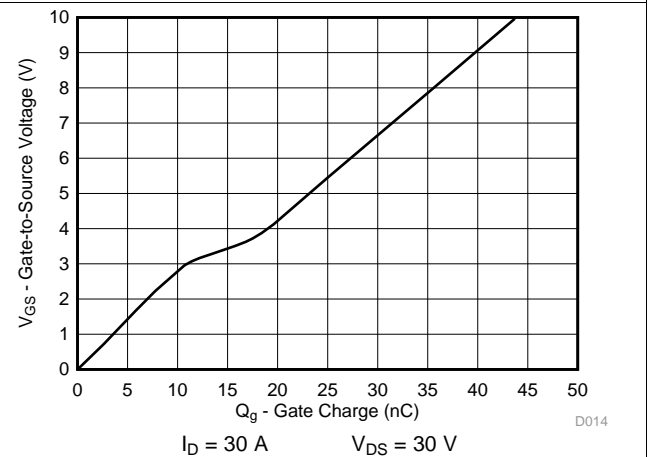

Figure 10. MOSFET Gate Charge

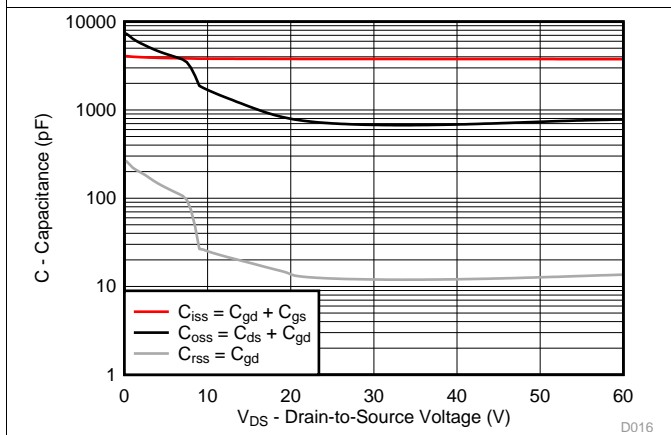

Figure 11. MOSFET Capacitance

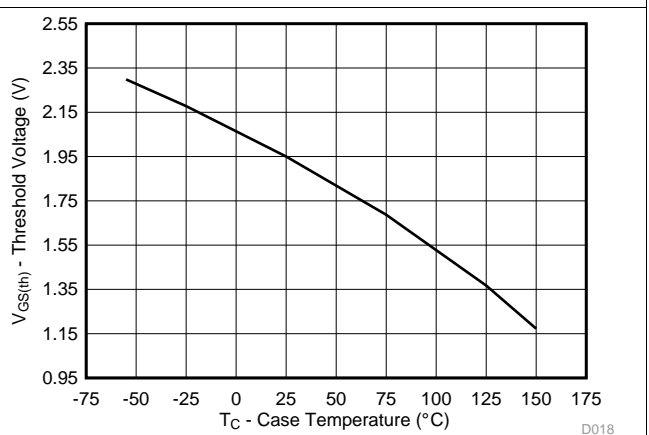
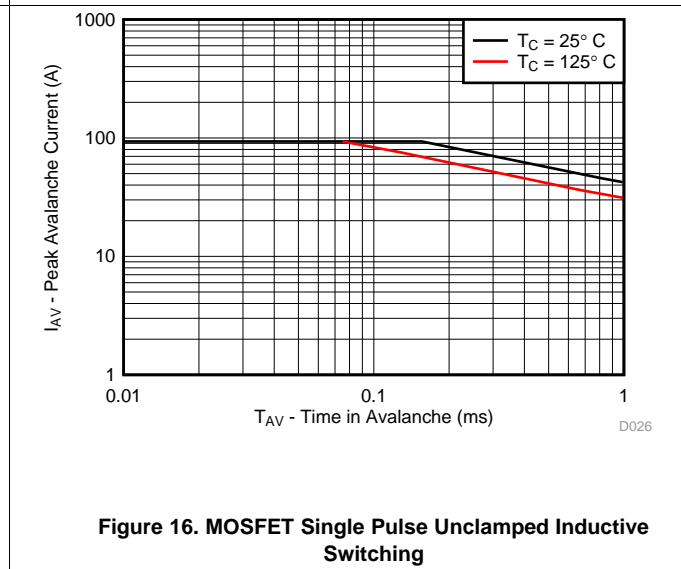
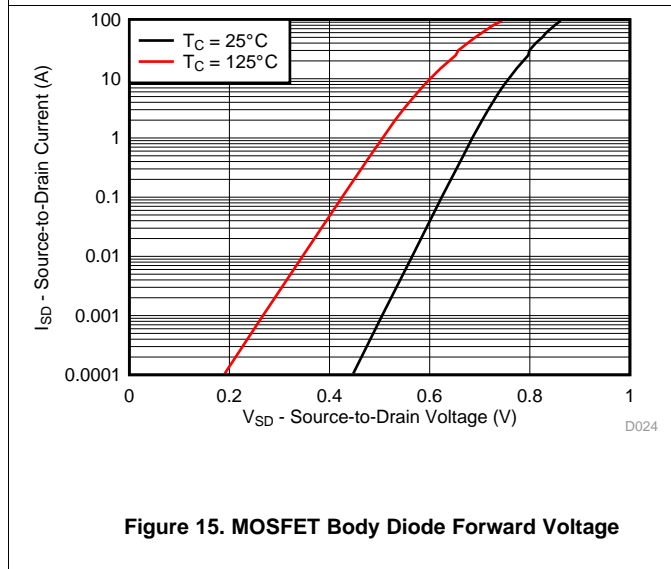
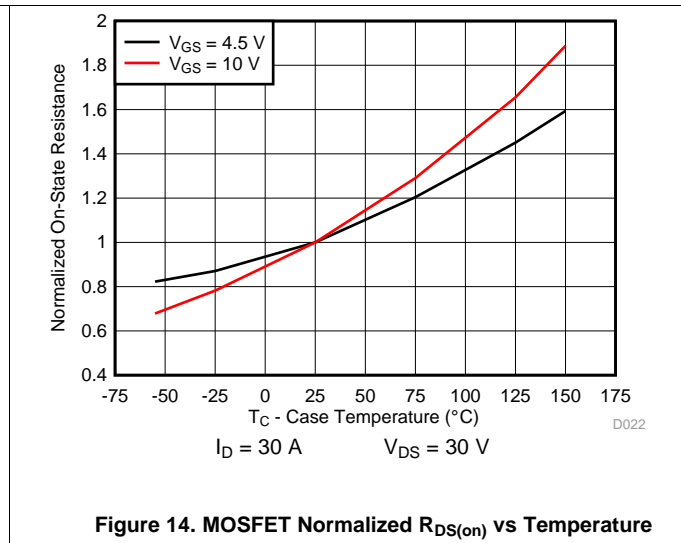
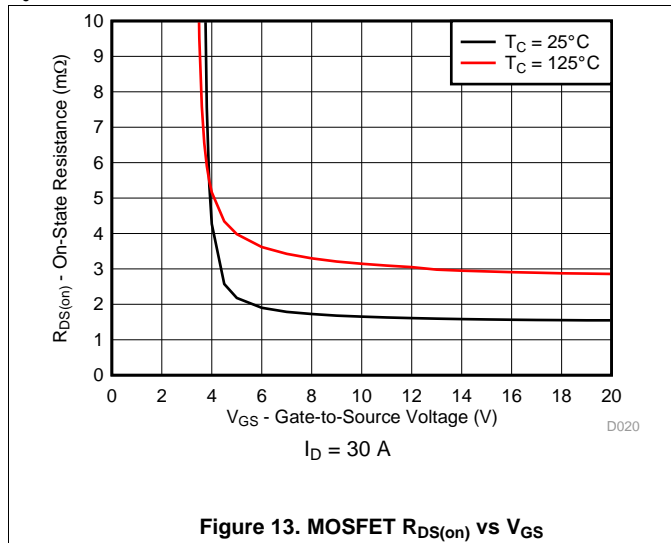

Figure 12. Threshold Voltage vs Temperature

Typical Power Block MOSFET Characteristics (continued)

$T_J = 25^\circ\text{C}$, unless stated otherwise.



6 Application and Implementation

NOTE

Information in the following Application section is not part of the TI component specification, and TI does not warrant its accuracy or completeness. TI customers are responsible for determining suitability of components selection for their designs. Customers should validate and test their design implementation to confirm system functionality.

6.1 Application Information

Historically, battery powered tools have favored brushed DC configurations to spin their primary motors, but more recently, the advantages offered by brushless DC operation (BLDC) operation have brought about the advent of popular designs that favor the latter. Those advantages include, but are not limited to higher efficiency and therefore longer battery life, superior reliability, greater peak torque capability, and smooth operation over a wider range of speeds. However, BLDC designs put increased demand for higher power density and current handling capabilities on the power stage responsible for driving the motor.

The CSD88599Q5DC is part of TI's power block product family and is a highly optimized product designed explicitly for the purpose driving higher current DC motors in power and gardening tools. It incorporates TI's latest generation silicon which has been optimized for low resistance to minimize conduction losses and offer excellent thermal performance. The power block utilizes TI's stacked die technology to offer one complete half bridge vertically integrated into a single 5-mm x 6-mm package with a DualCool exposed metal case. This feature allows the designer to apply a heatsink to the top of the package and pull heat away from the PCB, thus maximizing the power density while reducing the power stage footprint by up to 50%.

6.2 Brushless DC Motor With Trapezoidal Control

The trapezoidal commutation control is simple and has fewer switching losses compared to sinusoidal control.

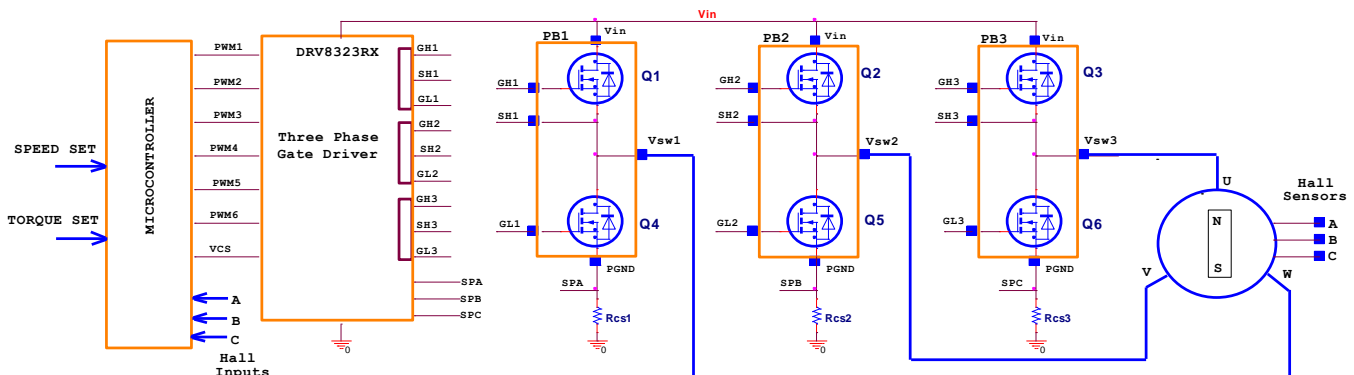

Copyright © 2017, Texas Instruments Incorporated

Figure 17. Functional Block Diagram

The block diagram shown in [Figure 17](#) offers a simple instruction of what is required to drive a BLDC motor: one microcontroller, one three-phase driver IC, 3 power blocks (historically 6 power MOSFETs) and 3 Hall effect sensors. The microcontroller responsible for block commutation must always know the rotor orientation or its position relative to the stator coils. This is easily achieved with a brushed DC motor due to the fixed geometry and position of the rotor windings, shaft and commutator.

A three-phase BLDC motor requires three Hall effect sensors or a rotary encoder to detect the rotor position in relation to stator armature windings. With input from these three Hall effect sensors output signals, the microcontroller can determine the proper commutation sequence. The three Hall sensors named A, B, and C are mounted on the stator core at 120° intervals and the stator phase windings are implemented in a star configuration. For every 60° of motor rotation, one Hall sensor changes its state. Based on the Hall sensors' output code, at the end of each block commutation interval the ampere conductors are commutated to the next position. There are 6 steps required to complete a full electrical cycle. The number of block commutation cycles to complete a full mechanical rotation is determined by the number of rotor pole pairs.

Brushless DC Motor With Trapezoidal Control (continued)

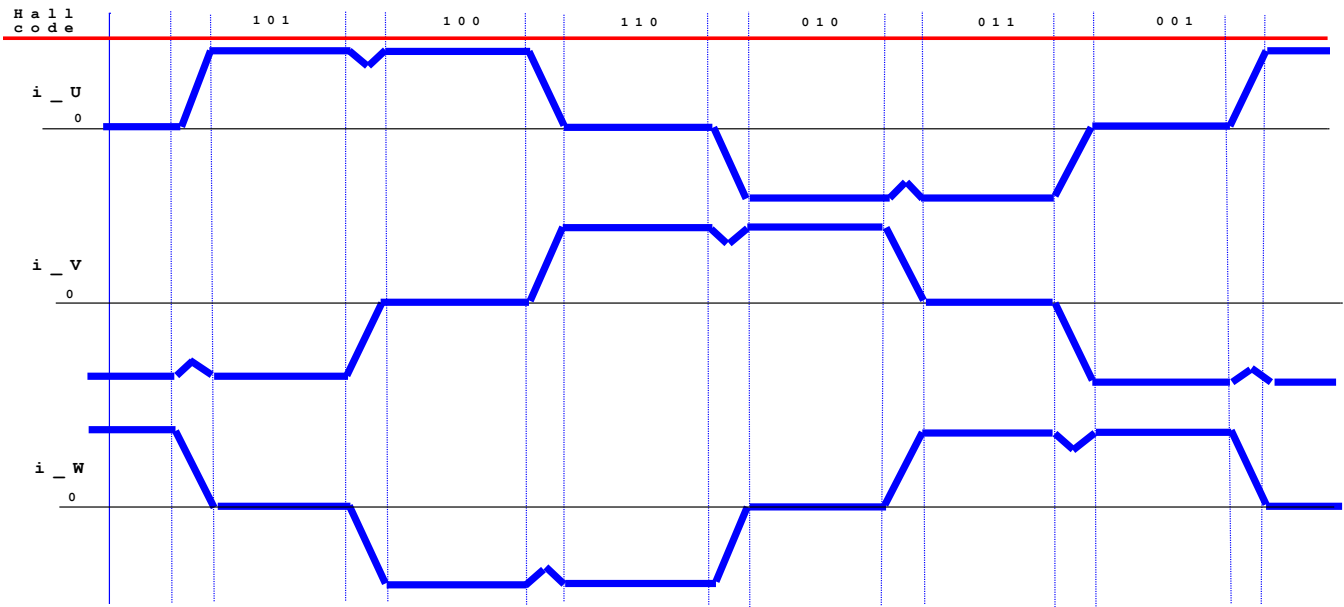

Figure 18. Winding Current Waveforms on a BLDC Motor

Figure 18 above shows the three phase motor winding currents i_U , i_V , and i_W when running at 100% duty cycle.

Trapezoidal commutation control offers the following advantages:

- Only two windings in series carry the phase winding current at any time while the third winding is open.
- Only one current sensor is necessary for all 3 windings U, V, and W.
- The position of the current sensor allows the use of low-cost shunt resistors.

However, trapezoidal commutation control has the disadvantage of commutation torque ripple. The current sense on a three-phase inverter can be configured to use a single-shunt or three different sense resistors. For cost sensitive applications targeting sensorless control, the three Hall effect sensors can be replaced with BEMF voltage feedback dividers.

To obtain faster motor rotations and higher revolutions per minute (RPM), shorter periods and higher V_{IN} voltage are necessary. Contrarily, to reduce the rotational speed of the motor, it is necessary to lower the RMS voltage applied across stator windings. This can easily be achieved by modulating the duty cycle, while maintain a constant switching frequency. Frequency for the three-phase inverter chosen is usually low between 10 kHz to 50 kHz to reduce winding losses and to avoid audible noise.

6.3 Power Loss Curves

CSD88599Q5DC was designed to operate up to 10-cell Li-Ion battery voltage applications ranging from 30 V to 42 V, typical 36 V. For 11 and 12s, input voltages between 42 V to 54 V, RC snubbers are required for each switch-node U, V, and W. To reduce ringing, refer to the [Electrical Performance](#) section. In an effort to simplify the design process, Texas Instruments has provided measured power loss performance curves over a variety of typical conditions.

Figure 1 plots the CSD88599Q5DC power loss as a function of load current. The measured power loss includes both input conversion loss and gate drive loss.

Equation 1 is used to generate the power loss curve:

$$\text{Power loss (W)} = (V_{IN} \times I_{IN_SHUNT}) + (V_{DD} \times I_{DD_SHUNT}) - (V_{SW_AVG} \times I_{OUT}) \tag{1}$$

The power loss measurements were made on the circuit shown in Figure 19. Power block devices for legs U and V, PB1 and PB2 were disabled by shorting the CSD88599Q5DC high-side and low-side FETs' gate-to-source terminals. Current shunt I_{IN_SHUNT} provides input current and I_{DD_SHUNT} provides driver supply current measurements. The winding current is measured from the DC load. An averaging circuit provides switch node W equivalent RMS voltage.

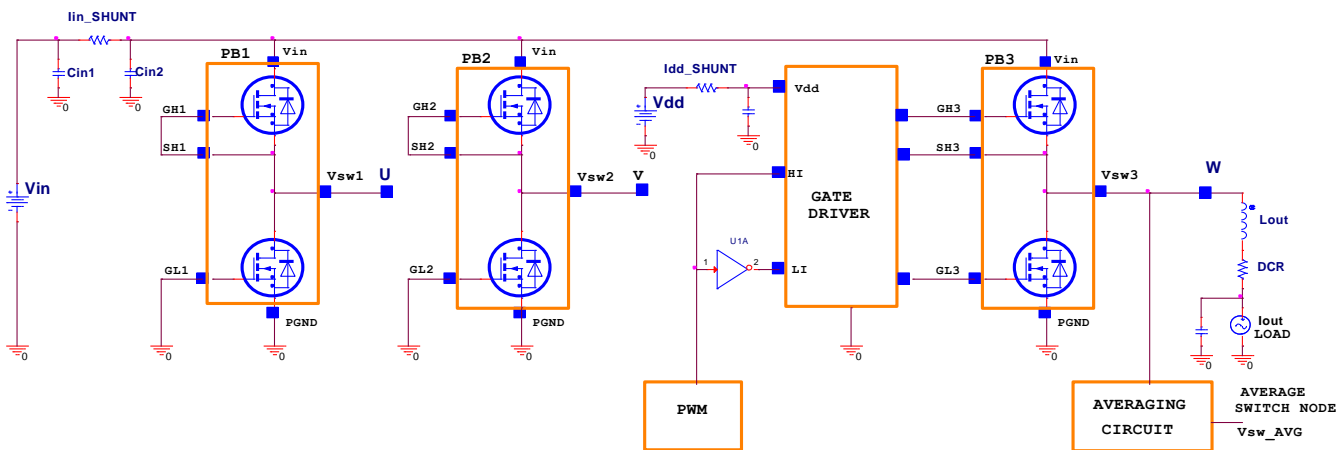

Copyright © 2017, Texas Instruments Incorporated

Figure 19. Power Loss Test Circuit

The RMS current on the CSD88599Q5DC device depends on the motor winding current. For trapezoidal control, the MOSFET RMS current is calculated using Equation 2.

$$I_{RMS} = I_{OUT} \times \sqrt{2} \tag{2}$$

Taking into consideration system tolerances with the current measurement scheme, the inverter design needs to withstand a 20% overload current.

Table 1. RMS and Overload Current Calculations

Winding RMS Current (A)	CSD88599Q5DC I_{RMS} (A)	Overload 20% $\times I_{RMS}$ (A)
20	28	34
30	42	51
40	56	68

6.4 Safe Operating Area (SOA) Curve

The SOA curve in [Figure 3](#) provides guidance on the temperature boundaries within an operating system by incorporating the thermal resistance and system power loss. This curve outlines the board and case temperatures required for a given load current. The area under the curve dictates the safe operating area. This curve is based on measurements made on a PCB design with dimensions of 4 in (W) × 3.5 in (L) × 0.062 in (H) and 6 copper layers of 1-oz copper thickness.

6.5 Normalized Power Loss Curves

The normalized curves in the CSD88599Q5DC data sheet provide guidance on the power loss and SOA adjustments based on application specific needs. These curves show how the power loss and SOA temperature boundaries will adjust for different operation conditions. The primary Y-axis is the normalized change in power loss while the secondary Y-axis is the change in system temperature required in order to comply with the SOA curve. The change in power loss is a multiplier for the typical power loss. The change in SOA temperature is subtracted from the SOA curve.

6.6 Design Example – Regulate Current to Maintain Safe Operation

If the case and board temperature of the power block are known, the SOA can be used to determine the maximum allowed current that will maintain operation within the safe operating area of the device. The following procedure outlines how to determine the RMS current limit while maintaining operation within the confines of the SOA, assuming the temperatures of the top of the package and PCB directly underneath the part are known.

1. Start at the maximum current of the device on the Y-axis and draw a line from this point at the known top case temperature to the known PCB temperature.
2. Observe where this point intersects the T_x line.
3. At this intersection with the T_x line, draw vertical line until you hit the SOA current limit. This intercept is the maximum allowed current at the corresponding power block PCB and case temperatures.

In the example below, we show how to achieve this for the temperatures $T_C = 124^\circ\text{C}$ and $T_B = 120^\circ\text{C}$. First we draw from 40 A on the Y-axis at 124°C to 120°C on the X-axis. Then, we draw a line up from where this line crosses the T_x line to see that this line intercepts the SOA at 34 A. Thus we can assume if we are measuring a PCB temperature of 124°C , and a top case temperature of 120°C , the power block can handle 34-A RMS, at the normalized conditions. At conditions that differ from those in [Figure 1](#), the user may be required to make an SOA temperature adjustment on the T_x line, as shown in the next section.

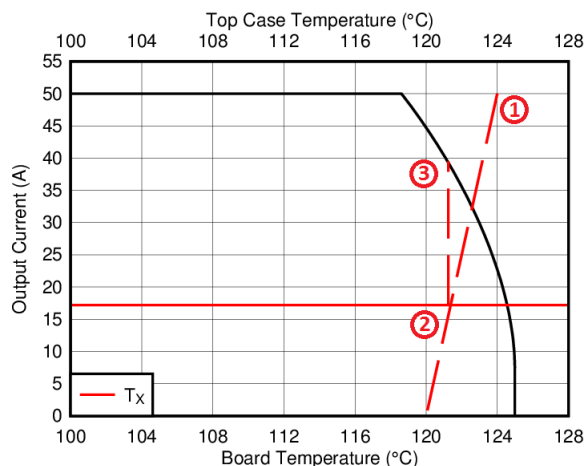

Figure 20. Regulating Current to Maintain Safe Operation

6.7 Design Example – Regulate Board and Case Temperature to Maintain Safe Operation

In the previous example we showed how given the PCB and case temperature, the current of the power block could be limited to ensure operation within the SOA. Conversely, if the current and other application conditions are known, one can determine from the SOA what board or case temperature the user will need to limit their design to. The user can estimate product loss and SOA boundaries by arithmetic means (see [Operating Conditions](#) section). Though the power loss and SOA curves in this data sheet are taken for a specific set of test conditions, the following procedure outlines the steps the user should take to predict product performance for any set of system conditions.

6.7.1 Operating Conditions

- Winding output current (I_{OUT}) = 30 A
- Input voltage (V_{IN}) = 42 V
- Switching frequency (F_{SW}) = 40 kHz
- Duty cycle (D.C.) = 95%

6.7.2 Calculating Power Loss

- Power loss at 30 A \approx 3.4 W ([Figure 1](#))
- Normalized power loss for switching frequency \approx 1.19 ([Figure 4](#))
- Normalized power loss for input voltage \approx 1.03 ([Figure 5](#))
- Normalized power loss for duty cycle \approx 1.12 ([Figure 6](#))
- **Final calculated power loss = 3.4 W \times 1.19 \times 1.03 \times 1.12 \approx 4.7 W**

6.7.3 Calculating SOA Adjustments

- SOA adjustment for switching frequency \approx 1.3°C ([Figure 4](#))
- SOA adjustment for input voltage \approx 0.1°C ([Figure 5](#))
- SOA adjustment for duty cycle \approx 0.7°C ([Figure 6](#))
- **Final calculated SOA adjustment = 1.3 + 0.1 + 0.7 \approx 2.1°C**

In the [Design Example – Regulate Current to Maintain Safe Operation](#) section above, the estimated power loss of the CSD88599Q5DC would increase to 4.7 W. In addition, the maximum allowable board temperature would have to increase by 2.1°C. In [Figure 21](#), the SOA graph was adjusted accordingly.

1. Start by drawing a horizontal line from the application current (30 A) to the SOA curve.
2. Draw a vertical line from the SOA curve intercept down to the T_X line.
3. Adjust the intersection point by subtracting the temperature adjustment value.

In this design example, the SOA board/ambient temperature adjustment yields a decrease of allowed junction temperature of 2.1°C from 122.2°C to 120.1°C. Now it is known that the intersection of the case and PCB temperatures on the T_X line must stay below this point. For instance, if the power block case is observed operating at 124°C, the PCB temperature must in turn be kept under 118°C to maintain this crossover point.

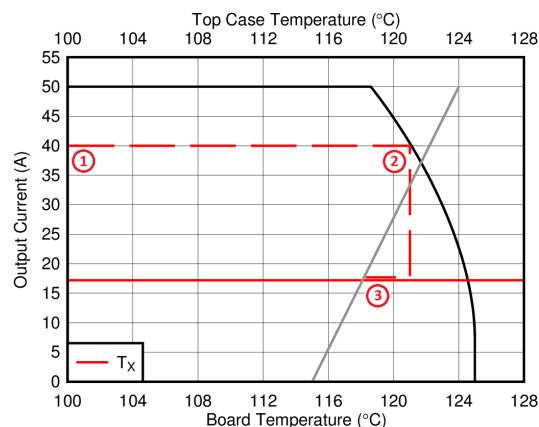

Figure 21. Regulate Temperature to Maintain Safe Operation

7 Layout

The two key system-level parameters that can be optimized with proper PCB design are electrical and thermal performance. A proper PCB layout will yield maximum performance in both areas. Below are some tips for how to address each.

7.1 Layout Guidelines

7.1.1 Electrical Performance

The CSD88599Q5DC power block has the ability to switch at voltage rates greater than 1 kV/ μ s. Special care must be then taken with the PCB layout design and placement of the input capacitors; high-current, high di/dt switching path; current shunt resistors; and GND return planes. As with any high-power inverter operated in hard switching mode, there will be voltage ringing present on the switch nodes U, V, and W. Switch-node ringing appears mainly at the HS FET turnon commutation with positive winding current direction. The U, V, and W phase connections to the BLDC motor can be usually excluded from the ringing behavior since they are subjected to high-peak currents but low di/dt slew-rates. However, a compact PCB design with short and low-parasitic loop inductances is critical to achieve low ringing and compliance with EMI specifications.

For safe and reliable operation of the three-phase inverter, motor phase currents have to be accurately monitored and reported to the system microcontroller. One current sensor needs to be connected on each motor phase winding U, V, and W. This sensing method is best for current sensing as it provides good accuracy over a wide range of duty cycles, motor torque, and winding currents. Using current sensors is recommended because it is less intrusive to the V_{IN} and GND connections.

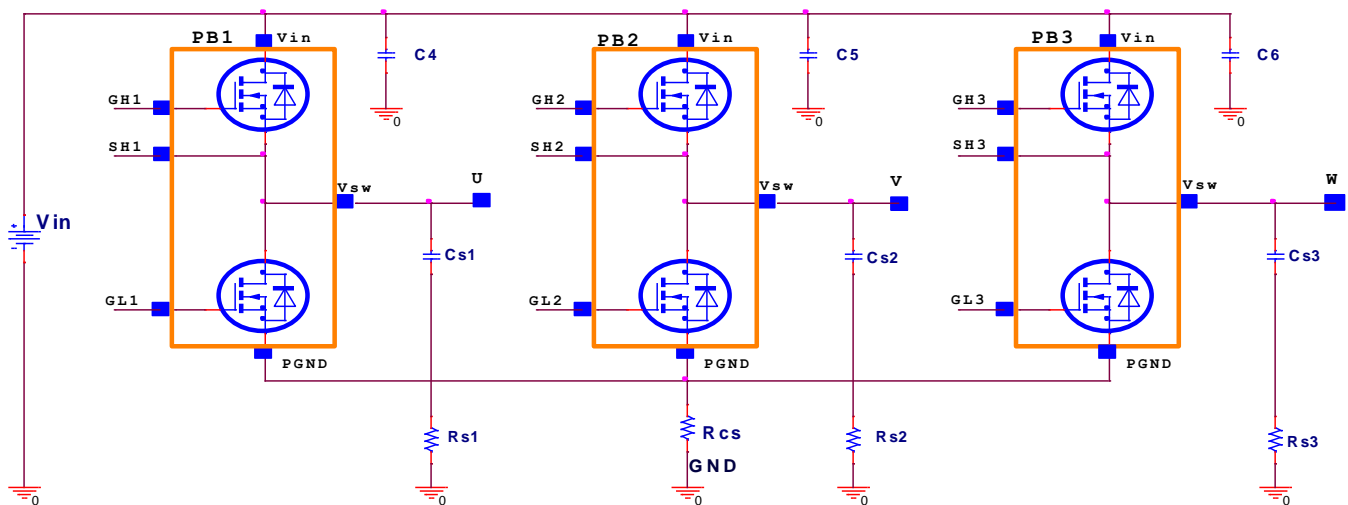

Copyright © 2017, Texas Instruments Incorporated

Figure 22. Recommended Ringing Reduction Components

However, for cost sensitive applications, current sensors are generally replaced with current sense resistors.

- For designs using the 60-V three-phase smart gate driver DRV8320SRHBR, only one current sense resistor R_{CS} can be placed between common source terminals for all 3 power block devices CSD88599Q5DC to PGND as depicted in Figure 22 above.
- For designs using the 60-V three-phase gate driver DRV8323RSRGZT, three current sense resistors R_{CS1} , R_{CS2} , and R_{CS3} can be used between each CSD88599Q5DC source terminals to GND. The three-phase driver IC should be placed as close as possible to the power block gate GL and GH terminals.

Layout Guidelines (continued)

Breaking the high-current flow path from the source terminals of the power block to GND by introducing the R_{CS} current shunt resistors introduces parasitic PCB inductance. In the event the switch node waveforms exhibits peak ringing that reaches undesirable levels, the ringing can be reduced by using the following ringing reduction components:

- The use of a high-side gate resistor in series with the GH pin is one effective way to reduce peak ringing. The recommended HS FET gate resistor value will range between 4.7 Ω to 10 Ω depending on the driver IC output characteristics used in conjunction with the power block device. The low-side FET gate pin GL should connect directly to the driver IC output to avoid any parasitic cdV/dT turnon effect.
- Low-inductance MLCC caps C4, C5, and C6 can be used across each power block device from V_{IN} to the source terminal P_{GND} . MLCC 10 nF, 100 V, $\pm 10\%$, X7S, 0402, PN: C1005X7S2A103K050BB are recommended.
- Ringing can be reduced via the implementation of RC snubbers from each switch node U, V, and W to GND. Recommended snubber component values are as follows:
 - Snubber resistors Rs1, Rs2, Rs3: 2.21 Ω , 1%, 0.125 W, 0805, PN: CRCW08052R21FKEA
 - Snubber caps Cs1, Cs2, and Cs3: MLCC 4.7 nF, 100 V, X7S, 0402, PN: C1005X7S2A472M050BB

With a switching frequency of 20 kHz on the three-phase inverter, the power dissipation on the RC snubber resistor is 80 mW per channel. As a result, 0805 package size for resistors Rs1, Rs2, and Rs3 is sufficient.

7.1.2 Thermal Considerations

The CSD88599Q5DC power block device has the ability to utilize the PCB copper planes as the primary thermal path. As such, the use of thermal vias included in the footprint is an effective way to pull away heat from the device and into the system board. Concerns regarding solder voids and manufacturability issues can be addressed through the use of three basic tactics to minimize the amount of solder attach that will wick down the via barrel.

- Intentionally space out the vias from one another to avoid a cluster of holes in a given area.
- Use the smallest drill size allowed by the design. The example in [Figure 23](#) uses vias with a 10-mil drill hole and a 16-mil solder pad.
- Tent the opposite side of the via with solder-mask. Ultimately the number and drill size of the thermal vias should align with the end user's PCB design rules and manufacturing capabilities.

To take advantage of the DualCool thermally enhanced package, an external heatsink can be applied on top of the power block devices. For low EMI, the heatsink is usually connected to GND through the mounting screws to the PCB. Gap pad insulators with good thermal conductivity should be used between the top of the package and the heatsink. The Bergquist Sil-Pad 980 is recommended which provides excellent thermal impedance of 1.07°C/W @ 50 psi.

7.2 Layout Example

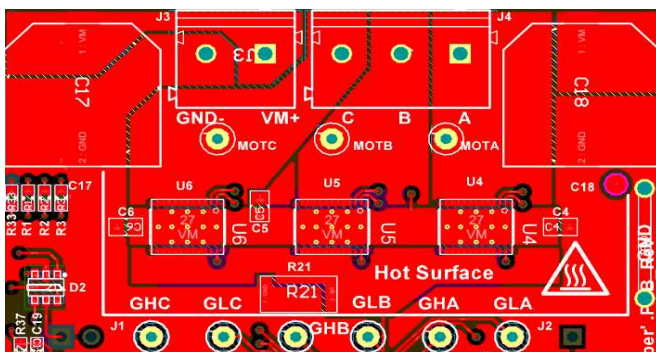

Figure 23. Top Layer

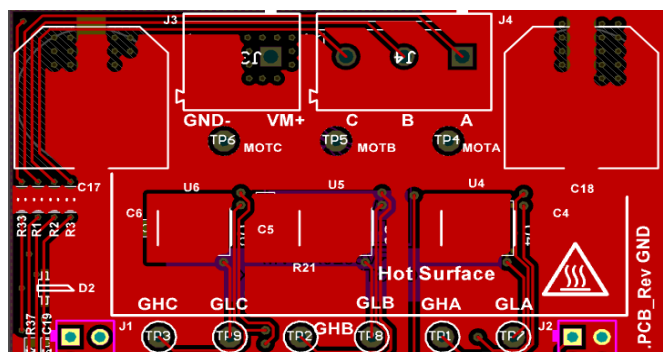

Figure 24. Bottom Layer

Layout Example (continued)

The placement of the input capacitors C4, C5, and C6 relative to V_{IN} and P_{GND} pins of CSD88599Q5DC device should have the highest priority during the component placement routine. It is critical to minimize the V_{IN} to GND parasitic loop inductance. A shunt resistor R21 is used between all three U4, U5, and U6 power block source terminals to the input supply GND return pin.

Input RMS current filtering is achieved via two bulk caps C17 and C18. Based on the RMS current ratings, the recommended part number for input bulk is CAP AL, 330 μ F, 63 V, \pm 20%, PN: EMVA630ADA331MKG5S.

8 Device and Documentation Support

8.1 Receiving Notification of Documentation Updates

To receive notification of documentation updates, navigate to the device product folder on ti.com. In the upper right corner, click on *Alert me* to register and receive a weekly digest of any product information that has changed. For change details, review the revision history included in any revised document.

8.2 Community Resources

The following links connect to TI community resources. Linked contents are provided "AS IS" by the respective contributors. They do not constitute TI specifications and do not necessarily reflect TI's views; see TI's [Terms of Use](#).

TI E2E™ Online Community *TI's Engineer-to-Engineer (E2E) Community*. Created to foster collaboration among engineers. At e2e.ti.com, you can ask questions, share knowledge, explore ideas and help solve problems with fellow engineers.

Design Support *TI's Design Support* Quickly find helpful E2E forums along with design support tools and contact information for technical support.

8.3 Trademarks

NexFET, DualCool, E2E are trademarks of Texas Instruments. All other trademarks are the property of their respective owners.

8.4 Electrostatic Discharge Caution



These devices have limited built-in ESD protection. The leads should be shorted together or the device placed in conductive foam during storage or handling to prevent electrostatic damage to the MOS gates.

8.5 Glossary

[SLYZ022](#) — *TI Glossary*.

This glossary lists and explains terms, acronyms, and definitions.

9 Mechanical, Packaging, and Orderable Information

The following pages include mechanical packaging and orderable information. This information is the most current data available for the designated devices. This data is subject to change without notice and revision of this document. For browser-based versions of this data sheet, refer to the left-hand navigation.

9.1 Q5DC Package Dimensions

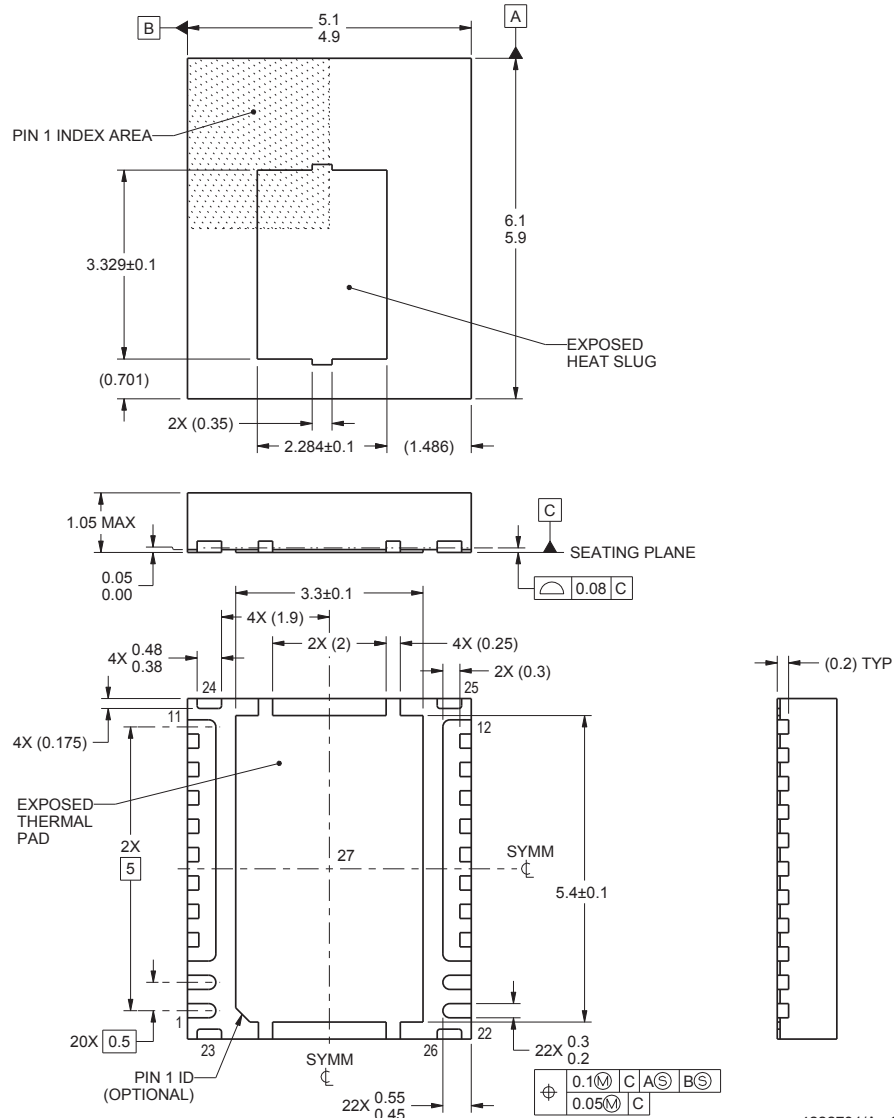

4222731/A 01/2016

- All linear dimensions are in millimeters. Any dimensions in parenthesis are for reference only. Dimensioning and tolerancing per ASME Y14.5M.
- This drawing is subject to change without notice.
- The package thermal pad must be soldered to the printed circuit board for thermal and mechanical performance.

Table 2. Pin Configuration Table

POSITION	PIN NAME	DESCRIPTION
1	GH	High Side Gate
2	SH	High Side Gate Return
3-11	V _{SW}	Switch Node
12-20	P _{GND}	Power Ground
21	NC	No Connect
22	GL	Low Side Gate
23-26	NC	No Connect
27	V _{IN}	Input Voltage

9.2 Land Pattern Recommendation

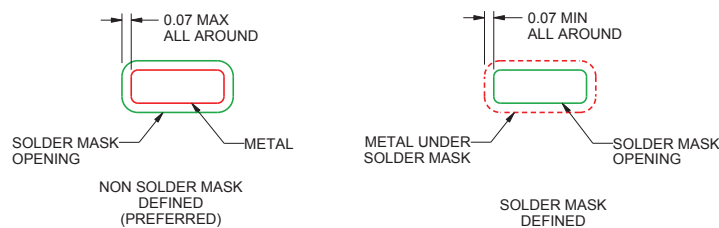
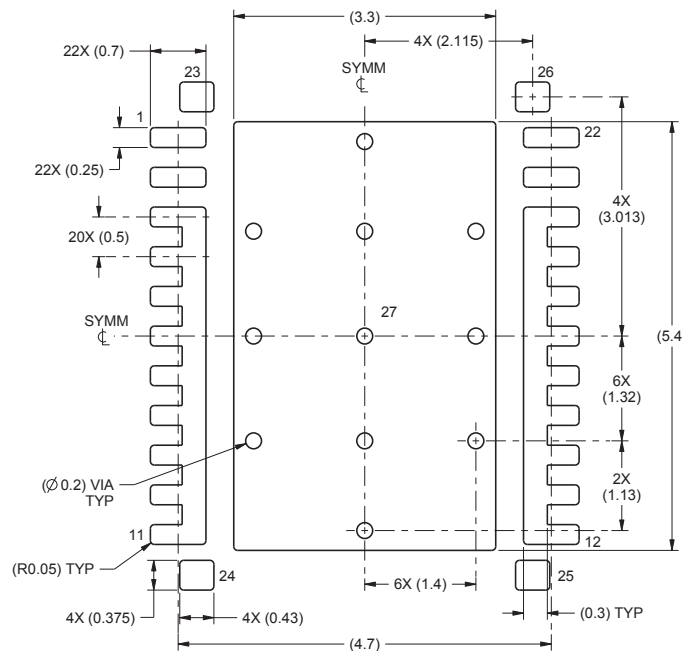

SOLDER MASK DETAILS

- All linear dimensions are in millimeters. Any dimensions in parenthesis are for reference only. Dimensioning and tolerancing per ASME Y14.5M.
- This package is designed to be soldered to a thermal pad on the board. For more information, see [QFN/SON PCB Attachment \(SLUA271\)](#).
- Vias are optional depending on application, refer to device data sheet. If some or all are implemented, recommended via locations are shown.

9.3 Stencil Recommendation

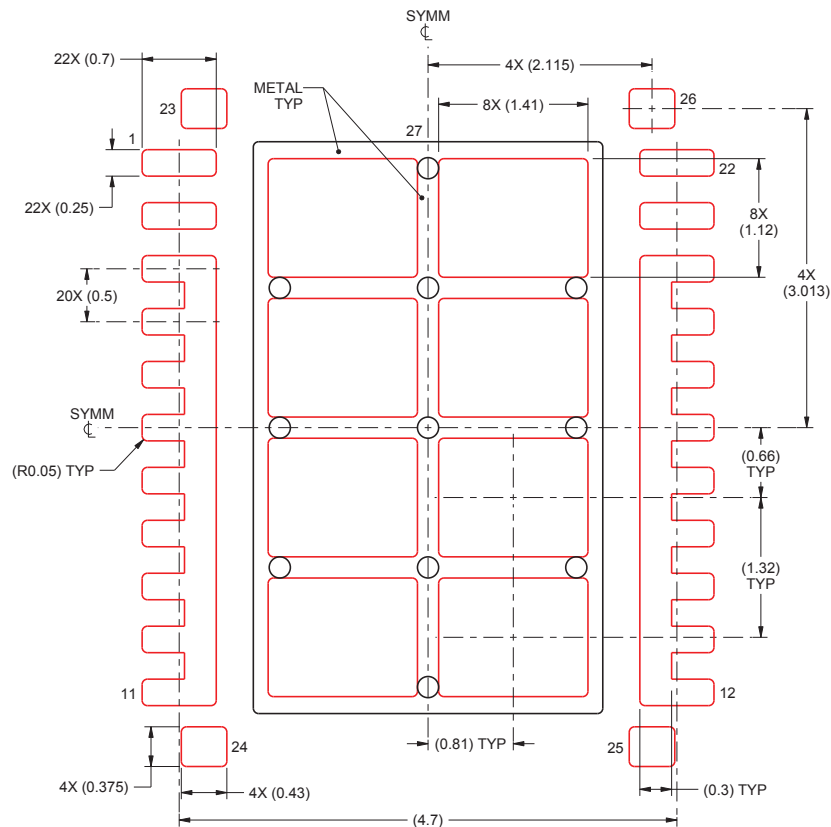

- All linear dimensions are in millimeters. Any dimensions in parenthesis are for reference only. Dimensioning and tolerancing per ASME Y14.5M.
- Laser cutting apertures with trapezoidal walls and rounded corners may offer better paste release. IPC-7525 may have alternate design recommendations.

For recommended circuit layout for PCB designs, see [Reducing Ringing Through PCB Layout Techniques \(SLPA005\)](#).

PACKAGING INFORMATION

Orderable Device	Status (1)	Package Type	Package Drawing	Pins	Package Qty	Eco Plan (2)	Lead/Ball Finish (6)	MSL Peak Temp (3)	Op Temp (°C)	Device Marking (4/5)	Samples
CSD88599Q5DC	ACTIVE	VSON-CLIP	DMM	22	2500	Pb-Free (RoHS Exempt)	CU SN	Level-1-260C-UNLIM	-55 to 150	88599	Samples
CSD88599Q5DCT	ACTIVE	VSON-CLIP	DMM	22	250	TBD	Call TI	Call TI	-55 to 150	88599	Samples

(1) The marketing status values are defined as follows:

ACTIVE: Product device recommended for new designs.

LIFEBUY: TI has announced that the device will be discontinued, and a lifetime-buy period is in effect.

NRND: Not recommended for new designs. Device is in production to support existing customers, but TI does not recommend using this part in a new design.

PREVIEW: Device has been announced but is not in production. Samples may or may not be available.

OBSOLETE: TI has discontinued the production of the device.

(2) **RoHS:** TI defines "RoHS" to mean semiconductor products that are compliant with the current EU RoHS requirements for all 10 RoHS substances, including the requirement that RoHS substance do not exceed 0.1% by weight in homogeneous materials. Where designed to be soldered at high temperatures, "RoHS" products are suitable for use in specified lead-free processes. TI may reference these types of products as "Pb-Free".

RoHS Exempt: TI defines "RoHS Exempt" to mean products that contain lead but are compliant with EU RoHS pursuant to a specific EU RoHS exemption.

Green: TI defines "Green" to mean the content of Chlorine (Cl) and Bromine (Br) based flame retardants meet JS709B low halogen requirements of <=1000ppm threshold. Antimony trioxide based flame retardants must also meet the <=1000ppm threshold requirement.

(3) MSL, Peak Temp. - The Moisture Sensitivity Level rating according to the JEDEC industry standard classifications, and peak solder temperature.

(4) There may be additional marking, which relates to the logo, the lot trace code information, or the environmental category on the device.

(5) Multiple Device Markings will be inside parentheses. Only one Device Marking contained in parentheses and separated by a "~" will appear on a device. If a line is indented then it is a continuation of the previous line and the two combined represent the entire Device Marking for that device.

(6) Lead/Ball Finish - Orderable Devices may have multiple material finish options. Finish options are separated by a vertical ruled line. Lead/Ball Finish values may wrap to two lines if the finish value exceeds the maximum column width.

Important Information and Disclaimer: The information provided on this page represents TI's knowledge and belief as of the date that it is provided. TI bases its knowledge and belief on information provided by third parties, and makes no representation or warranty as to the accuracy of such information. Efforts are underway to better integrate information from third parties. TI has taken and continues to take reasonable steps to provide representative and accurate information but may not have conducted destructive testing or chemical analysis on incoming materials and chemicals. TI and TI suppliers consider certain information to be proprietary, and thus CAS numbers and other limited information may not be available for release.

In no event shall TI's liability arising out of such information exceed the total purchase price of the TI part(s) at issue in this document sold by TI to Customer on an annual basis.

IMPORTANT NOTICE

Texas Instruments Incorporated (TI) reserves the right to make corrections, enhancements, improvements and other changes to its semiconductor products and services per JESD46, latest issue, and to discontinue any product or service per JESD48, latest issue. Buyers should obtain the latest relevant information before placing orders and should verify that such information is current and complete.

TI's published terms of sale for semiconductor products (<http://www.ti.com/sc/docs/stdterms.htm>) apply to the sale of packaged integrated circuit products that TI has qualified and released to market. Additional terms may apply to the use or sale of other types of TI products and services.

Reproduction of significant portions of TI information in TI data sheets is permissible only if reproduction is without alteration and is accompanied by all associated warranties, conditions, limitations, and notices. TI is not responsible or liable for such reproduced documentation. Information of third parties may be subject to additional restrictions. Resale of TI products or services with statements different from or beyond the parameters stated by TI for that product or service voids all express and any implied warranties for the associated TI product or service and is an unfair and deceptive business practice. TI is not responsible or liable for any such statements.

Buyers and others who are developing systems that incorporate TI products (collectively, "Designers") understand and agree that Designers remain responsible for using their independent analysis, evaluation and judgment in designing their applications and that Designers have full and exclusive responsibility to assure the safety of Designers' applications and compliance of their applications (and of all TI products used in or for Designers' applications) with all applicable regulations, laws and other applicable requirements. Designer represents that, with respect to their applications, Designer has all the necessary expertise to create and implement safeguards that (1) anticipate dangerous consequences of failures, (2) monitor failures and their consequences, and (3) lessen the likelihood of failures that might cause harm and take appropriate actions. Designer agrees that prior to using or distributing any applications that include TI products, Designer will thoroughly test such applications and the functionality of such TI products as used in such applications.

TI's provision of technical, application or other design advice, quality characterization, reliability data or other services or information, including, but not limited to, reference designs and materials relating to evaluation modules, (collectively, "TI Resources") are intended to assist designers who are developing applications that incorporate TI products; by downloading, accessing or using TI Resources in any way, Designer (individually or, if Designer is acting on behalf of a company, Designer's company) agrees to use any particular TI Resource solely for this purpose and subject to the terms of this Notice.

TI's provision of TI Resources does not expand or otherwise alter TI's applicable published warranties or warranty disclaimers for TI products, and no additional obligations or liabilities arise from TI providing such TI Resources. TI reserves the right to make corrections, enhancements, improvements and other changes to its TI Resources. TI has not conducted any testing other than that specifically described in the published documentation for a particular TI Resource.

Designer is authorized to use, copy and modify any individual TI Resource only in connection with the development of applications that include the TI product(s) identified in such TI Resource. NO OTHER LICENSE, EXPRESS OR IMPLIED, BY ESTOPPEL OR OTHERWISE TO ANY OTHER TI INTELLECTUAL PROPERTY RIGHT, AND NO LICENSE TO ANY TECHNOLOGY OR INTELLECTUAL PROPERTY RIGHT OF TI OR ANY THIRD PARTY IS GRANTED HEREIN, including but not limited to any patent right, copyright, mask work right, or other intellectual property right relating to any combination, machine, or process in which TI products or services are used. Information regarding or referencing third-party products or services does not constitute a license to use such products or services, or a warranty or endorsement thereof. Use of TI Resources may require a license from a third party under the patents or other intellectual property of the third party, or a license from TI under the patents or other intellectual property of TI.

TI RESOURCES ARE PROVIDED "AS IS" AND WITH ALL FAULTS. TI DISCLAIMS ALL OTHER WARRANTIES OR REPRESENTATIONS, EXPRESS OR IMPLIED, REGARDING RESOURCES OR USE THEREOF, INCLUDING BUT NOT LIMITED TO ACCURACY OR COMPLETENESS, TITLE, ANY EPIDEMIC FAILURE WARRANTY AND ANY IMPLIED WARRANTIES OF MERCHANTABILITY, FITNESS FOR A PARTICULAR PURPOSE, AND NON-INFRINGEMENT OF ANY THIRD PARTY INTELLECTUAL PROPERTY RIGHTS. TI SHALL NOT BE LIABLE FOR AND SHALL NOT DEFEND OR INDEMNIFY DESIGNER AGAINST ANY CLAIM, INCLUDING BUT NOT LIMITED TO ANY INFRINGEMENT CLAIM THAT RELATES TO OR IS BASED ON ANY COMBINATION OF PRODUCTS EVEN IF DESCRIBED IN TI RESOURCES OR OTHERWISE. IN NO EVENT SHALL TI BE LIABLE FOR ANY ACTUAL, DIRECT, SPECIAL, COLLATERAL, INDIRECT, PUNITIVE, INCIDENTAL, CONSEQUENTIAL OR EXEMPLARY DAMAGES IN CONNECTION WITH OR ARISING OUT OF TI RESOURCES OR USE THEREOF, AND REGARDLESS OF WHETHER TI HAS BEEN ADVISED OF THE POSSIBILITY OF SUCH DAMAGES.

Unless TI has explicitly designated an individual product as meeting the requirements of a particular industry standard (e.g., ISO/TS 16949 and ISO 26262), TI is not responsible for any failure to meet such industry standard requirements.

Where TI specifically promotes products as facilitating functional safety or as compliant with industry functional safety standards, such products are intended to help enable customers to design and create their own applications that meet applicable functional safety standards and requirements. Using products in an application does not by itself establish any safety features in the application. Designers must ensure compliance with safety-related requirements and standards applicable to their applications. Designer may not use any TI products in life-critical medical equipment unless authorized officers of the parties have executed a special contract specifically governing such use. Life-critical medical equipment is medical equipment where failure of such equipment would cause serious bodily injury or death (e.g., life support, pacemakers, defibrillators, heart pumps, neurostimulators, and implantables). Such equipment includes, without limitation, all medical devices identified by the U.S. Food and Drug Administration as Class III devices and equivalent classifications outside the U.S.

TI may expressly designate certain products as completing a particular qualification (e.g., Q100, Military Grade, or Enhanced Product). Designers agree that it has the necessary expertise to select the product with the appropriate qualification designation for their applications and that proper product selection is at Designers' own risk. Designers are solely responsible for compliance with all legal and regulatory requirements in connection with such selection.

Designer will fully indemnify TI and its representatives against any damages, costs, losses, and/or liabilities arising out of Designer's non-compliance with the terms and provisions of this Notice.