

CD4028BM/CD4028BC BCD-to-Decimal Decoder

General Description

The CD4028BM/CD4028BC is a BCD-to-decimal or binary-to-octal decoder consisting of 4 inputs, decoding logic gates, and 10 output buffers. A BCD code applied to the 4 inputs, A, B, C, and D, results in a high level at the selected 1-of-10 decimal decoded outputs. Similarly, a 3-bit binary code applied to inputs A, B, and C is decoded in octal at outputs 0–7. A high level signal at the D input inhibits octal decoding and causes outputs 0–7 to go low.

All inputs are protected against static discharge damage by diode clamps to V_{DD} and V_{SS} .

Features

- Wide supply voltage range 3.0V to 15V
- High noise immunity 0.45 V_{DD} (typ.)
- Low power TTL compatibility fan out of 2 driving 74L or 1 driving 74LS
- Low power
- Glitch free outputs
- "Positive logic" on inputs and outputs

Applications

- Code conversion
- Address decoding
- Indicator-tube decoder

Logic and Connection Diagrams

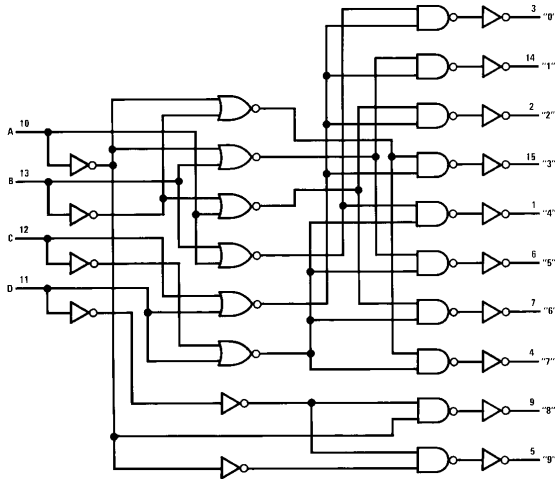

TL/F/5959-1

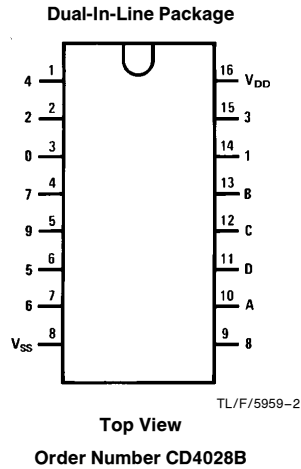

TL/F/5959-2

Truth Table

1 = High Level
0 = Low Level

D	C	B	A	0	1	2	3	4	5	6	7	8	9
0	0	0	0	1	0	0	0	0	0	0	0	0	0
0	0	0	1	0	1	0	0	0	0	0	0	0	0
0	0	1	0	0	0	1	0	0	0	0	0	0	0
0	0	1	1	0	0	0	1	0	0	0	0	0	0
0	1	0	0	0	0	0	0	1	0	0	0	0	0
0	1	0	1	0	0	0	0	0	1	0	0	0	0
0	1	1	0	0	0	0	0	0	0	1	0	0	0
0	1	1	1	0	0	0	0	0	0	0	1	0	0
1	0	0	0	0	0	0	0	0	0	0	0	1	0
1	0	0	1	0	0	0	0	0	0	0	0	0	1
1	0	1	0	0	0	0	0	0	0	0	0	1	0
1	0	1	1	0	0	0	0	0	0	0	0	0	1
1	1	0	0	0	0	0	0	0	0	0	0	1	0
1	1	0	1	0	0	0	0	0	0	0	0	0	1
1	1	1	0	0	0	0	0	0	0	0	0	1	0
1	1	1	1	0	0	0	0	0	0	0	0	0	1

BCD States

Extraordinary States

Absolute Maximum Ratings (Notes 1 & 2)

If Military/Aerospace specified devices are required, please contact the National Semiconductor Sales Office/Distributors for availability and specifications.

Supply Voltage (V_{DD})	-0.5 to +18V
Input Voltage (V_{IN})	-0.5 to V_{DD} + 0.5V
Storage Temperature Range (T_S)	-65°C to +150°C
Power Dissipation (P_D)	
Dual-In-Line	700 mW
Small Outline	500 mW
Lead Temperature (T_L)	
(Soldering, 10 seconds)	260°C

Recommended Operating Conditions (Note 2)

Supply Voltage (V_{DD})	3 to 15V
Input Voltage (V_{IN})	0 to V_{DD} V
Operating Temperature Range (T_A)	
CD4028BM	-55°C to +125°C
CD4028BC	-40°C to +185°C

DC Electrical Characteristics CD4028BC (Note 2)

Symbol	Parameter	Conditions	-55°C		+25°C			+125°C		Units
			Min	Max	Min	Typ	Max	Min	Max	
I_{DD}	Quiescent Device Current	$V_{DD} = 5V, V_{IN} = V_{DD}$ or V_{SS}		5		0.01	5		150	μA
		$V_{DD} = 10V, V_{IN} = V_{DD}$ or V_{SS}		10		0.01	10		300	μA
		$V_{DD} = 15V, V_{IN} = V_{DD}$ or V_{SS}		20		0.02	20		600	μA
V_{OL}	Low Level Output Voltage	$ I_O < 1 \mu A, V_{IL} = 0V, V_{IH} = V_{DD}$								
		$V_{DD} = 5V$		0.05		0	0.05		0.05	V
		$V_{DD} = 10V$		0.05		0	0.05		0.05	V
		$V_{DD} = 15V$		0.05		0	0.05		0.05	V
V_{OH}	High Level Output Voltage	$ I_O < 1 \mu A, V_{IL} = 0V, V_{IH} = V_{DD}$								
		$V_{DD} = 5V$	4.95		4.95	5		4.95		V
		$V_{DD} = 10V$	9.95		9.95	10		9.95		V
		$V_{DD} = 15V$	14.95		14.95	15		14.95		V
V_{IL}	Low Level Input Voltage	$ I_O < 1 \mu A$								
		$V_{DD} = 5V, V_O = 0.5V$ or $4.5V$		1.5		2.25	1.5		1.5	V
		$V_{DD} = 10V, V_O = 1V$ or $9V$		3.0		4.5	3.0		3.0	V
		$V_{DD} = 15V, V_O = 1.5V$ or $13.5V$		4.0		6.75	4.0		4.0	V
V_{IH}	High Level Input Voltage	$ I_O < 1 \mu A$								
		$V_{DD} = 5V, V_O = 0.5V$ or $4.5V$	3.5		3.5	2.75		3.5		V
		$V_{DD} = 10V, V_O = 1V$ or $9V$	7.0		7.0	5.5		7.0		V
		$V_{DD} = 15V, V_O = 1.5V$ or $13.5V$	11.0		11.0	8.25		11.0		V
I_{OL}	Low Level Output Current (Note 3)	$V_{IL} = 0V, V_{IH} = V_{DD}$								
		$V_{DD} = 5V, V_O = 0.4V$	0.64		0.51	1.0		0.36		mA
		$V_{DD} = 10V, V_O = 0.5V$	1.6		1.3	2.6		0.9		mA
		$V_{DD} = 15V, V_O = 1.5V$	4.2		3.4	6.8		2.4		mA
I_{OH}	High Level Output Current (Note 3)	$V_{IL} = 0V, V_{IH} = V_{DD}$								
		$V_{DD} = 5V, V_O = 4.6V$	-0.25		-0.2	-0.4		-0.14		mA
		$V_{DD} = 10V, V_O = 9.5V$	-0.62		-0.5	-1.0		-0.35		mA
		$V_{DD} = 15V, V_O = 13.5V$	-1.8		-1.5	-3.0		-1.1		mA
I_{IN}	Input Current	$V_{DD} = 15V, V_{IN} = 0V$		-0.1		-10^{-5}	-0.1		-1.0	μA
		$V_{DD} = 15V, V_{IN} = 15V$		0.1		10^{-5}	0.1		1.0	μA

DC Electrical Characteristics CD4028BC (Note 2)

Symbol	Parameter	Conditions	-40°C		+25°C			+85°C		Units
			Min	Max	Min	Typ	Max	Min	Max	
I_{DD}	Quiescent Device Current	$V_{DD} = 5V, V_{IN} = V_{DD}$ or V_{SS}		20		0.01	20		150	μA
		$V_{DD} = 10V, V_{IN} = V_{DD}$ or V_{SS}		40		0.01	40		300	μA
		$V_{DD} = 15V, V_{IN} = V_{DD}$ or V_{SS}		80		0.02	80		600	μA
V_{OL}	Low Level Output Voltage	$ I_O < 1 \mu A, V_{IL} = 0V, V_{IH} = V_{DD}$								
		$V_{DD} = 5V$		0.05		0	0.05		0.05	V
		$V_{DD} = 10V$		0.05		0	0.05		0.05	V
		$V_{DD} = 15V$		0.05		0	0.05		0.05	V

DC Electrical Characteristics CD4028BC (Note 2) (Continued)

Symbol	Parameter	Conditions	-40°C		+25°C			+85°C		Units
			Min	Max	Min	Typ	Max	Min	Max	
V _{OH}	High Level Output Voltage	I _O < 1 μA, V _{IL} = 0V, V _{IH} = V _{DD} V _{DD} = 5V V _{DD} = 10V V _{DD} = 15V	4.95		4.95	5		4.95		V
			9.95		9.95	10		9.95		V
			14.95		14.95	15		14.95		V
V _{IL}	Low Level Input Voltage	I _O < 1 μA V _{DD} = 5V, V _O = 0.5V or 4.5V V _{DD} = 10V, V _O = 1V or 9V V _{DD} = 15V, V _O = 1.5V or 13.5V		1.5		2.25	1.5		1.5	V
				3.0		4.5	3.0		3.0	V
				4.0		6.75	4.0		4.0	V
V _{IH}	High Level Input Voltage	I _O < 1 μA V _{DD} = 5V, V _O = 0.5V or 4.5V V _{DD} = 10V, V _O = 1V or 9V V _{DD} = 15V, V _O = 1.5V or 13.5V	3.5		3.5			3.5		V
			7.0		7.0			7.0		V
			11.0		11.0			11.0		V
I _{OL}	Low Level Output Current (Note 3)	V _{IH} = V _{DD} , V _{IL} = 0V V _{DD} = 5V, V _O = 0.4V V _{DD} = 10V, V _O = 0.5V V _{DD} = 15V, V _O = 1.5V	0.52		0.44	0.88		0.36		mA
			1.3		1.1	2.2		0.9		mA
			3.6		3.0	6.0		2.4		mA
I _{OH}	High Level Output Current (Note 3)	V _{IH} = V _{DD} , V _{IL} = 0V V _{DD} = 5V, V _O = 4.6V V _{DD} = 10V, V _O = 9.5V V _{DD} = 15V, V _O = 13.5V	-0.2		-0.16	-0.32		-0.12		mA
			-0.5		-0.4	-0.8		-0.3		mA
			-1.4		-1.2	-3.5		-1.0		mA
I _{IN}	Input Current	V _{DD} = 15V, V _{IN} = 0V V _{DD} = 15V, V _{IN} = 15V		-0.3			-0.3		-1.0	μA
				0.3			0.3		1.0	μA

AC Electrical Characteristics*

T_A = 25°C, C_L = 50 pF, R_L = 200k, Input t_r = t_f = 20 ns, unless otherwise specified

Symbol	Parameter	Conditions	Min	Typ	Max	Units
t _{PHL} or t _{PLH}	Propagation Delay Time	V _{CC} = 5V		240	480	ns
		V _{CC} = 10V		100	200	ns
		V _{CC} = 15V		70	140	ns
t _{THL} or t _{TLH}	Transition Time	V _{CC} = 5V		175	350	ns
		V _{CC} = 10V		75	150	ns
		V _{CC} = 15V		60	110	ns
C _{IN}	Input Capacitance	Any Input		5	7.5	pF

* AC Parameters are guaranteed by DC correlated testing.

Note 1: "Absolute Maximum Ratings" are those values beyond which the safety of the device cannot be guaranteed, they are not meant to imply that the devices should be operated at these limits. The table of "Recommended Operating Conditions" and "Electrical Characteristics" provides conditions for actual device operation.

Note 2: V_{SS} = 0V unless otherwise specified.

Note 3: I_{OL} and I_{OH} are tested one output at a time.

Switching Time Waveforms

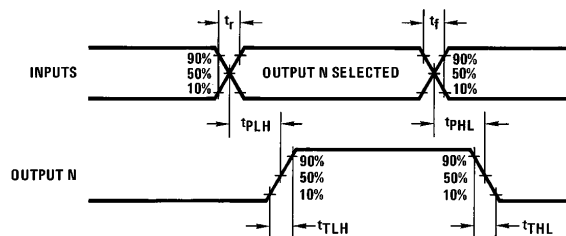

TL/F/5959-3

Physical Dimensions inches (millimeters)

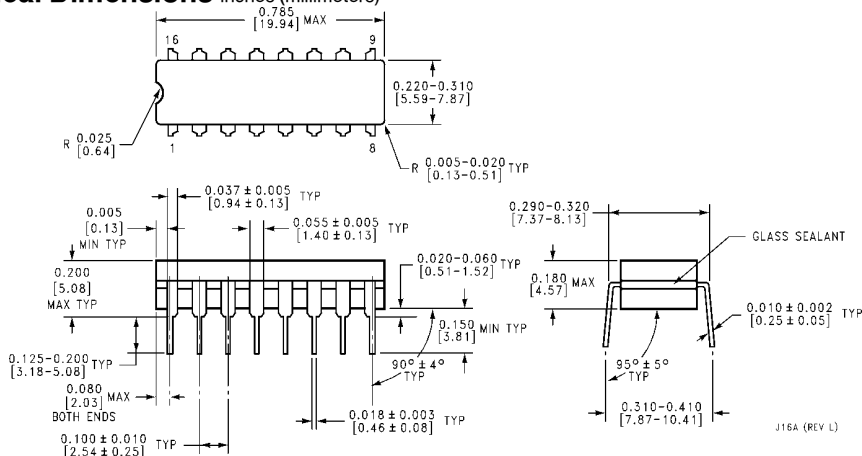

Ceramic Dual-In-Line Package (J)
Order Number CD4028BMJ or CD4028BCJ
NS Package Number J16A

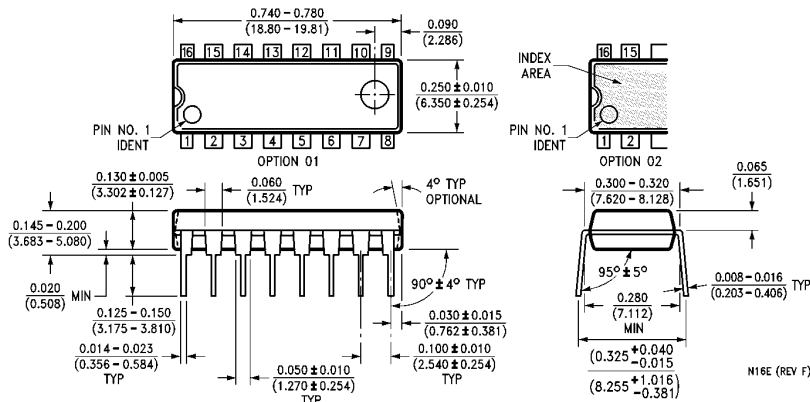

Molded Dual-In-Line Package (N)
Order Number CD4028BMN or CD4028BCN
NS Package Number N16E

LIFE SUPPORT POLICY

NATIONAL'S PRODUCTS ARE NOT AUTHORIZED FOR USE AS CRITICAL COMPONENTS IN LIFE SUPPORT DEVICES OR SYSTEMS WITHOUT THE EXPRESS WRITTEN APPROVAL OF THE PRESIDENT OF NATIONAL SEMICONDUCTOR CORPORATION. As used herein:

1. Life support devices or systems are devices or systems which, (a) are intended for surgical implant into the body, or (b) support or sustain life, and whose failure to perform, when properly used in accordance with instructions for use provided in the labeling, can be reasonably expected to result in a significant injury to the user.
2. A critical component is any component of a life support device or system whose failure to perform can be reasonably expected to cause the failure of the life support device or system, or to affect its safety or effectiveness.



National Semiconductor Corporation
 1111 West Bardin Road
 Arlington, TX 76017
 Tel: (800) 272-9959
 Fax: (800) 737-7018

National Semiconductor Europe
 Fax: (+49) 0-180-530 85 86
 Email: cnjwge@tevm2.nsc.com
 Deutsch Tel: (+49) 0-180-530 85 85
 English Tel: (+49) 0-180-532 78 32
 Français Tel: (+49) 0-180-532 93 58
 Italiano Tel: (+49) 0-180-534 16 80

National Semiconductor Hong Kong Ltd.
 19th Floor, Straight Block,
 Ocean Centre, 5 Canton Rd.
 Tsimshatsui, Kowloon
 Hong Kong
 Tel: (852) 2737-1600
 Fax: (852) 2736-9960

National Semiconductor Japan Ltd.
 Tel: 81-043-299-2309
 Fax: 81-043-299-2408

National does not assume any responsibility for use of any circuitry described, no circuit patent licenses are implied and National reserves the right at any time without notice to change said circuitry and specifications.