

DATA SHEET

BLU86 UHF power transistor

Product specification

September 1991

UHF power transistor

BLU86

FEATURES

- SMD encapsulation
- Emitter-ballasting resistors for optimum temperature profile
- Gold metallization ensures excellent reliability.

DESCRIPTION

NPN silicon planar epitaxial transistor encapsulated in a SOT223 surface mounted envelope and designed primarily for use in mobile radio equipment in the 900 MHz communications band.

PINNING - SOT223

PIN	DESCRIPTION
1	emitter
2	base
3	emitter
4	collector

QUICK REFERENCE DATA

RF performance at $T_s \leq 60 \text{ }^\circ\text{C}$ in a common emitter class-B test circuit (see note 1).

MODE OF OPERATION	f (MHz)	V _{CE} (V)	P _L (W)	G _p (dB)	η_c (%)
c.w. narrow band	900	12.5	1	> 7	> 55

Note

1. T_s = temperature at soldering point of collector tab.

PIN CONFIGURATION

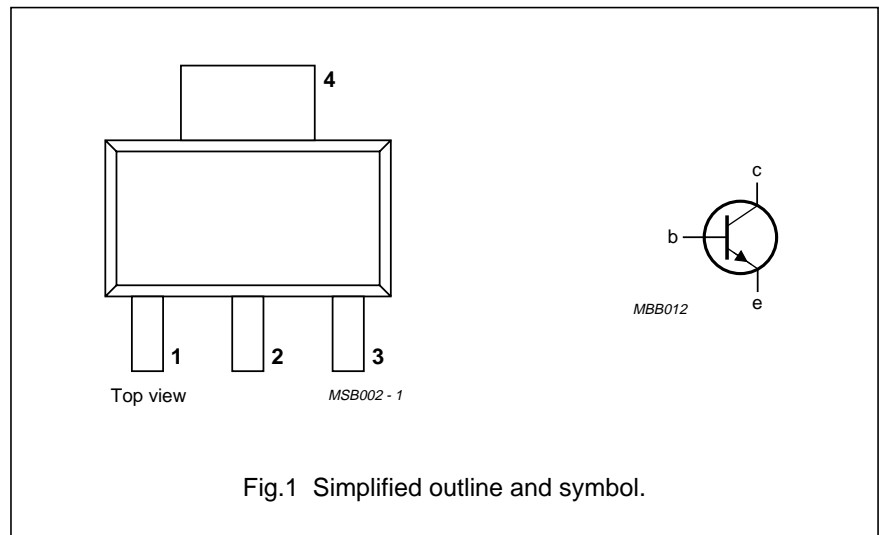

UHF power transistor

BLU86

LIMITING VALUES

In accordance with the Absolute Maximum System (IEC 134).

SYMBOL	PARAMETER	CONDITIONS	MIN.	MAX.	UNIT
V_{CBO}	collector-base voltage	open emitter	–	32	V
V_{CEO}	collector-emitter voltage	open base	–	16	V
V_{EBO}	emitter-base voltage	open collector	–	3	V
$I_C, I_{C(AV)}$	collector current	DC or average value	–	200	mA
I_{CM}	collector current	peak value; $f > 1$ MHz	–	600	mA
P_{tot}	total power dissipation	$f > 1$ MHz; $T_s = 129$ °C (note 1)	–	2	W
T_{stg}	storage temperature range		–65	150	°C
T_j	operating junction temperature		–	175	°C

Note

- T_s = temperature at soldering point of collector tab.

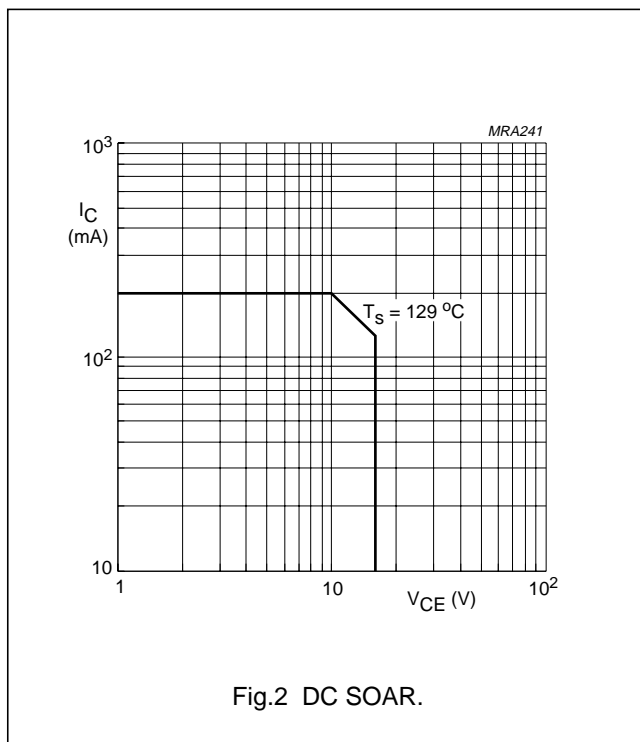
**THERMAL RESISTANCE**

SYMBOL	PARAMETER	CONDITIONS	MAX.	UNIT
$R_{th\ j-s(DC)}$	from junction to soldering point	$P_{tot} = 2$ W; $T_s = 129$ °C	23	K/W

UHF power transistor

BLU86

CHARACTERISTICS

$T_j = 25\text{ }^\circ\text{C}$.

SYMBOL	PARAMETER	CONDITIONS	MIN.	TYP.	MAX.	UNIT
$V_{(BR)CBO}$	collector-base breakdown voltage	open emitter; $I_C = 2.5\text{ mA}$	32	–	–	V
$V_{(BR)CEO}$	collector-emitter breakdown voltage	open base; $I_C = 10\text{ mA}$	16	–	–	V
$V_{(BR)EBO}$	emitter-base breakdown voltage	open collector; $I_E = 0.5\text{ mA}$	3	–	–	V
I_{CES}	collector-emitter leakage current	$V_{BE} = 0$; $V_{CE} = 16\text{ V}$	–	–	1	mA
h_{FE}	DC current gain	$V_{CE} = 10\text{ V}$; $I_C = 150\text{ mA}$	25	–	–	
E_{SBR}	second breakdown energy	$L = 25\text{ mH}$; $R_{BE} = 10\text{ }\Omega$; $f = 50\text{ Hz}$	0.3	–	–	mJ
C_C	collector capacitance	$V_{CB} = 12.5\text{ V}$; $I_E = I_e = 0$; $f = 1\text{ MHz}$	–	2.2	2.6	pF
C_{re}	feedback capacitance	$V_{CE} = 12.5\text{ V}$; $I_C = 0$; $f = 1\text{ MHz}$	–	1.2	1.8	pF

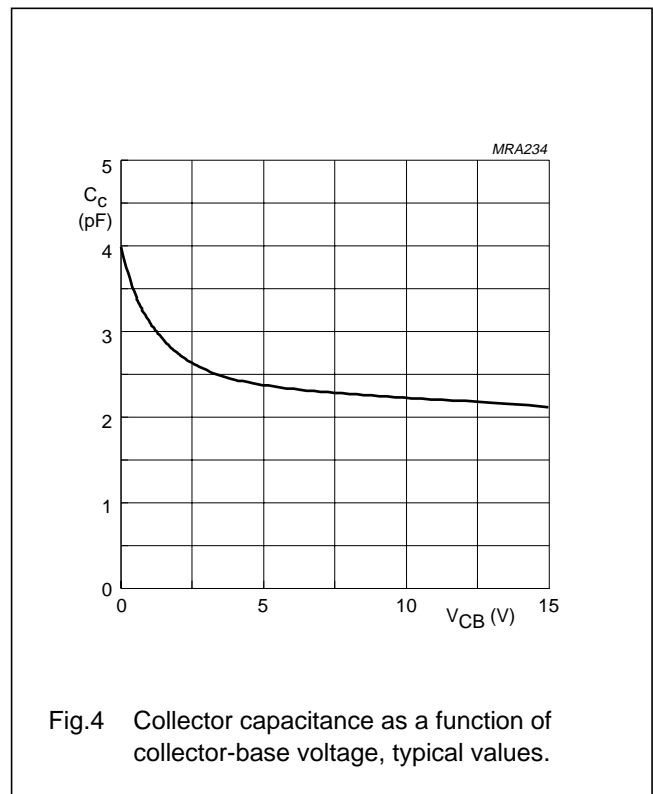
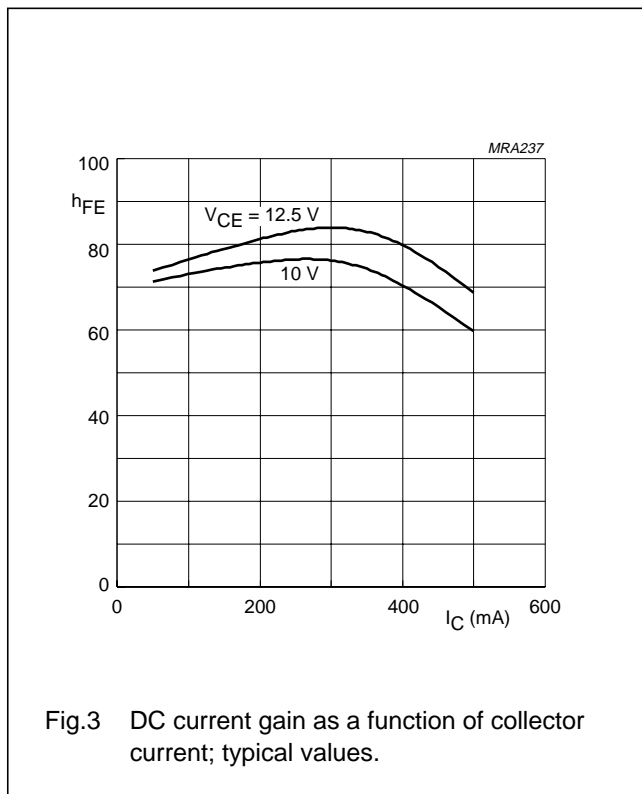

UHF power transistor

BLU86

APPLICATION INFORMATION

RF performance at $T_s \leq 60\text{ }^\circ\text{C}$; in a common emitter class-B test circuit (see note 1).

MODE OF OPERATION	f (MHz)	V _{CE} (V)	P _L (W)	G _p (dB)	η_c (%)
c.w. narrow band	900	12.5	1	> 7 typ. 7.7	> 55 typ. 66

Note

1. T_s = temperature at soldering point of collector tab.

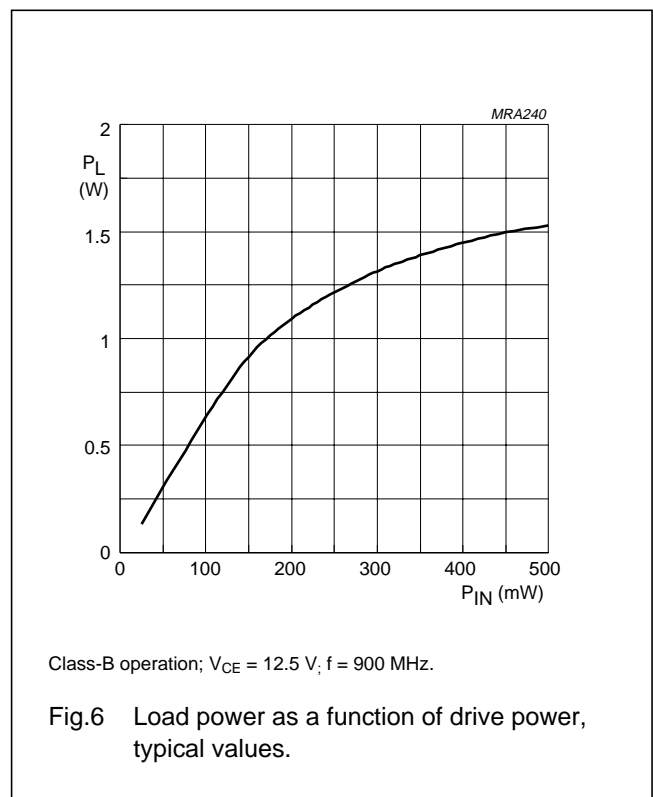
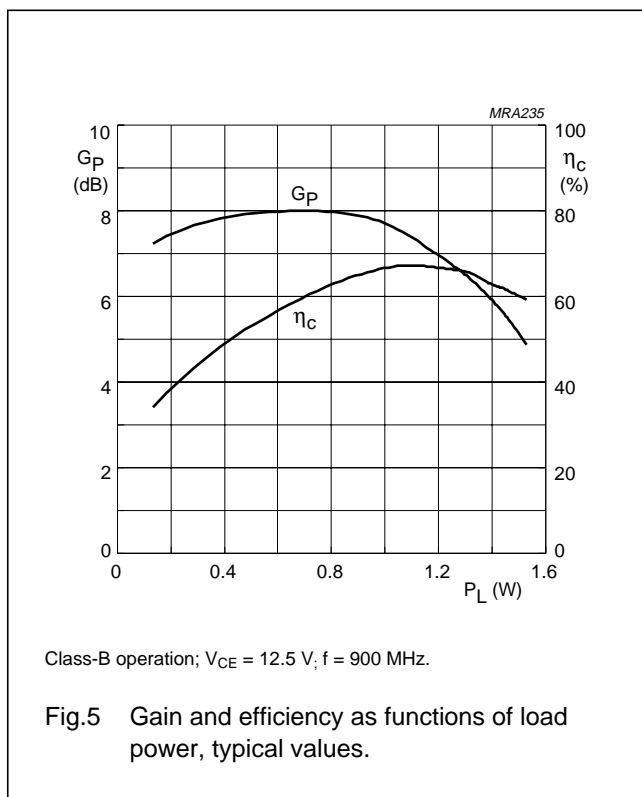

Ruggedness in class-B operation

The BLU86 is capable of withstanding a full load mismatch corresponding to VSWR = 50:1 through all phases at rated output power, up to a supply voltage of 15.5 V, f = 900 MHz and $T_s \leq 60\text{ }^\circ\text{C}$, where T_s is the temperature at the soldering point of the collector tab.

UHF power transistor

BLU86

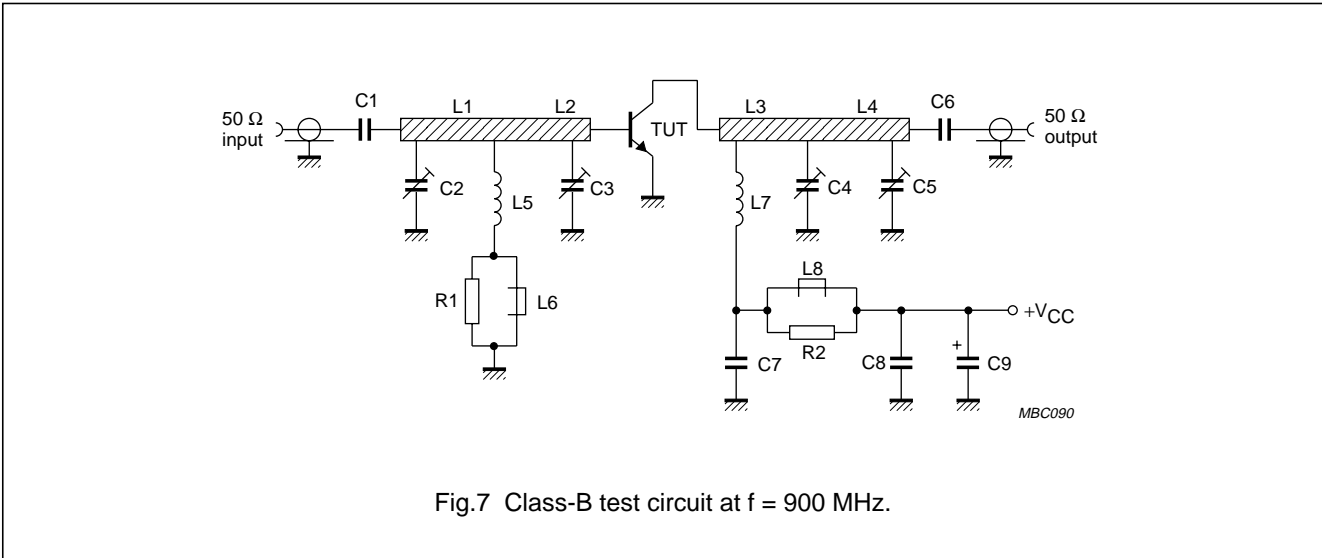

Fig.7 Class-B test circuit at f = 900 MHz.

List of components (see test circuit)

COMPONENT	DESCRIPTION	VALUE	DIMENSIONS	CATALOGUE NO.
C1, C6	multilayer ceramic chip capacitor (note 1)	100 pF		
C2, C3, C4, C5	film dielectric trimmer	1.4 to 5.5 pF		2222 809 09001
C7	multilayer ceramic chip capacitor (note 1)	220 pF		
C8	multilayer ceramic chip capacitor (note 1)	1 nF		
C9	63 V electrolytic capacitor	2.2 μF		
L1	stripline (note 2)	50 Ω	17 mm × 4.7 mm	
L2	stripline (note 2)	50 Ω	5 mm × 4.7 mm	
L3	stripline (note 2)	50 Ω	32 mm × 4.7 mm	
L4	stripline (note 2)	50 Ω	20 mm × 4.7 mm	
L5, L7	6 turns enamelled 0.8 mm copper wire		int. dia. 3 mm	
L6, L8	grade 3B1 Ferroxcube wideband HF choke			4312 020 36640
R1, R2	0.25 W metal film resistor	10 Ω, 5%		

Notes

1. American Technical Ceramics (ATC) capacitor, type 100B or other capacitor of the same quality.
2. The striplines are mounted on a double copper-clad printed circuit board, with PTFE fiber-glass dielectric ($\epsilon_r = 2.2$); thickness $1/16$ inch.

UHF power transistor

BLU86

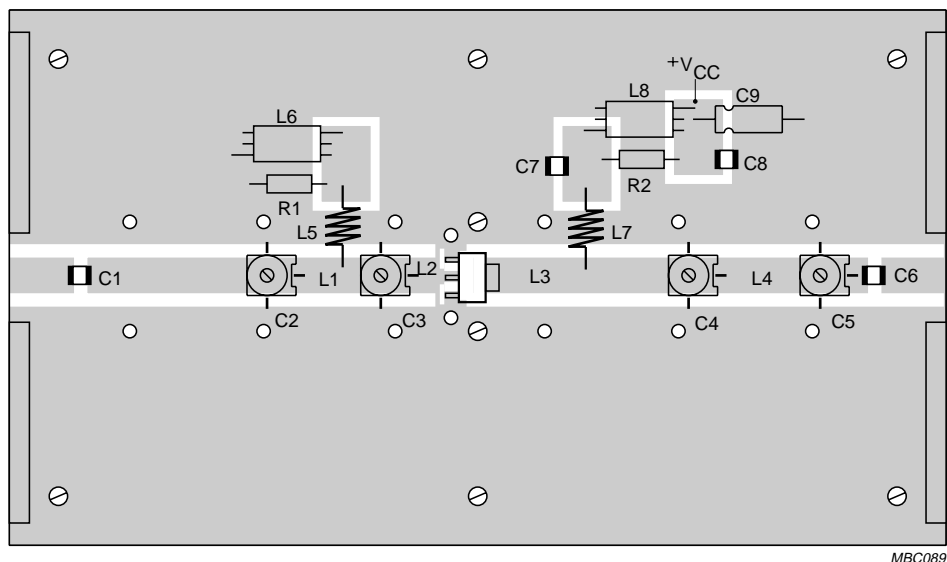
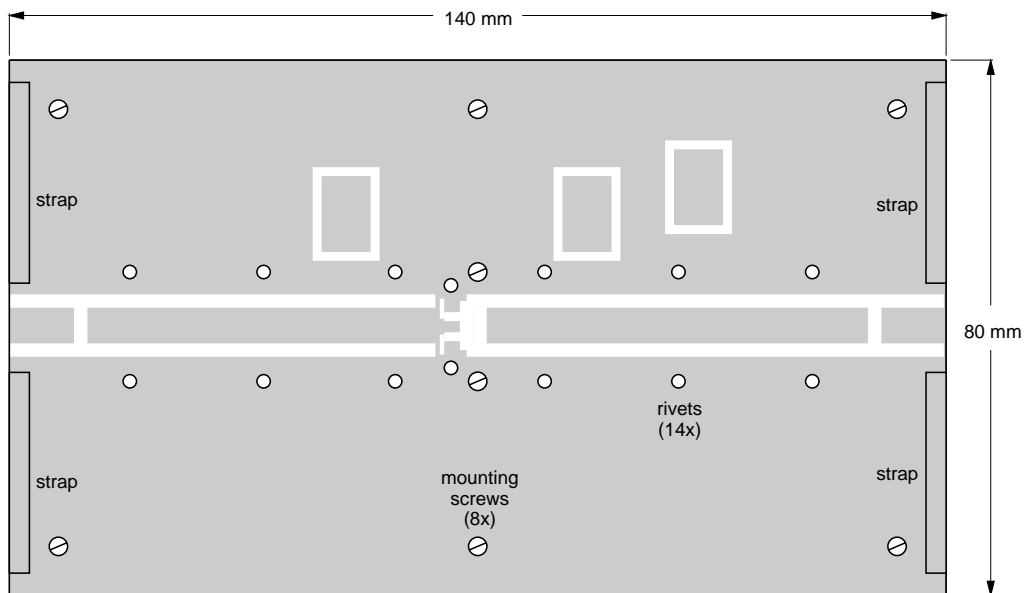

MBC089

The circuit and components are situated on one side of a copper-clad PTFE fibre-glass board; the other side is unetched and serves as a ground plane. Earth connections from the component side to the ground plane are made by means of fixing screws, hollow rivets and copper foil straps, as shown.

Fig.8 Component layout for 900 MHz class-B test circuit.

UHF power transistor

BLU86

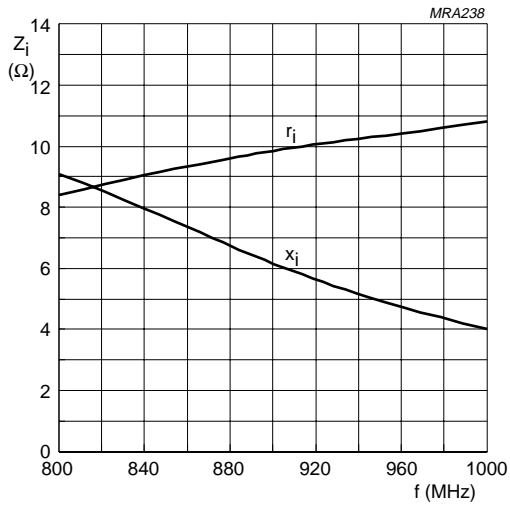

Class-B operation; $V_{CE} = 12.5$ V; $P_L = 1$ W.

Fig.9 Input impedance (series components) as a function of frequency, typical values.

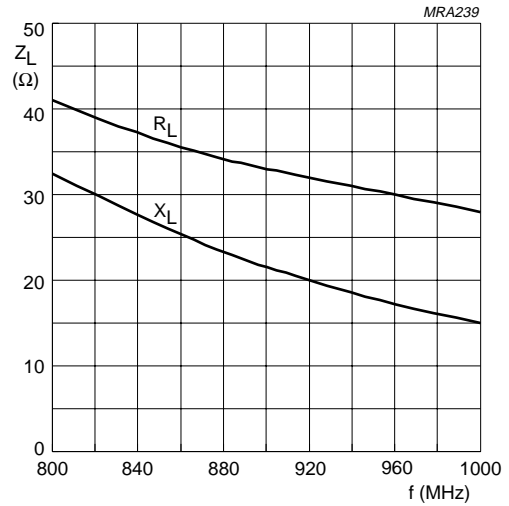

Class-B operation; $V_{CE} = 12.5$ V; $P_L = 1$ W.

Fig.10 Load impedance (series components) as a function of frequency, typical values.

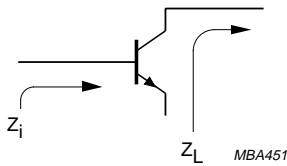
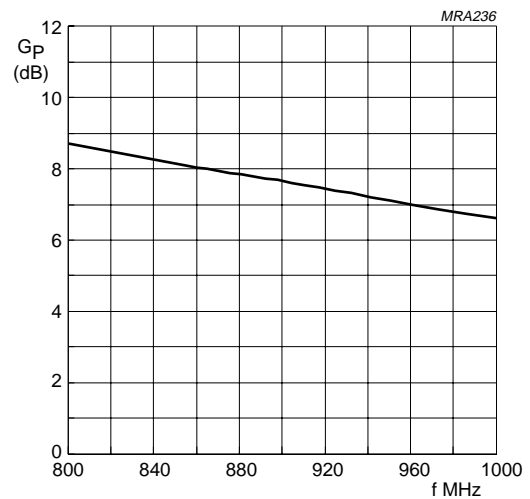

Fig.11 Definition of transistor impedance.



Class-B operation; $V_{CE} = 12.5$ V; $P_L = 1$ W.

Fig.12 Power gain as a function of frequency, typical values.

UHF power transistor

BLU86

PACKAGE OUTLINE

Plastic surface mounted package; collector pad for good heat transfer; 4 leads

SOT223

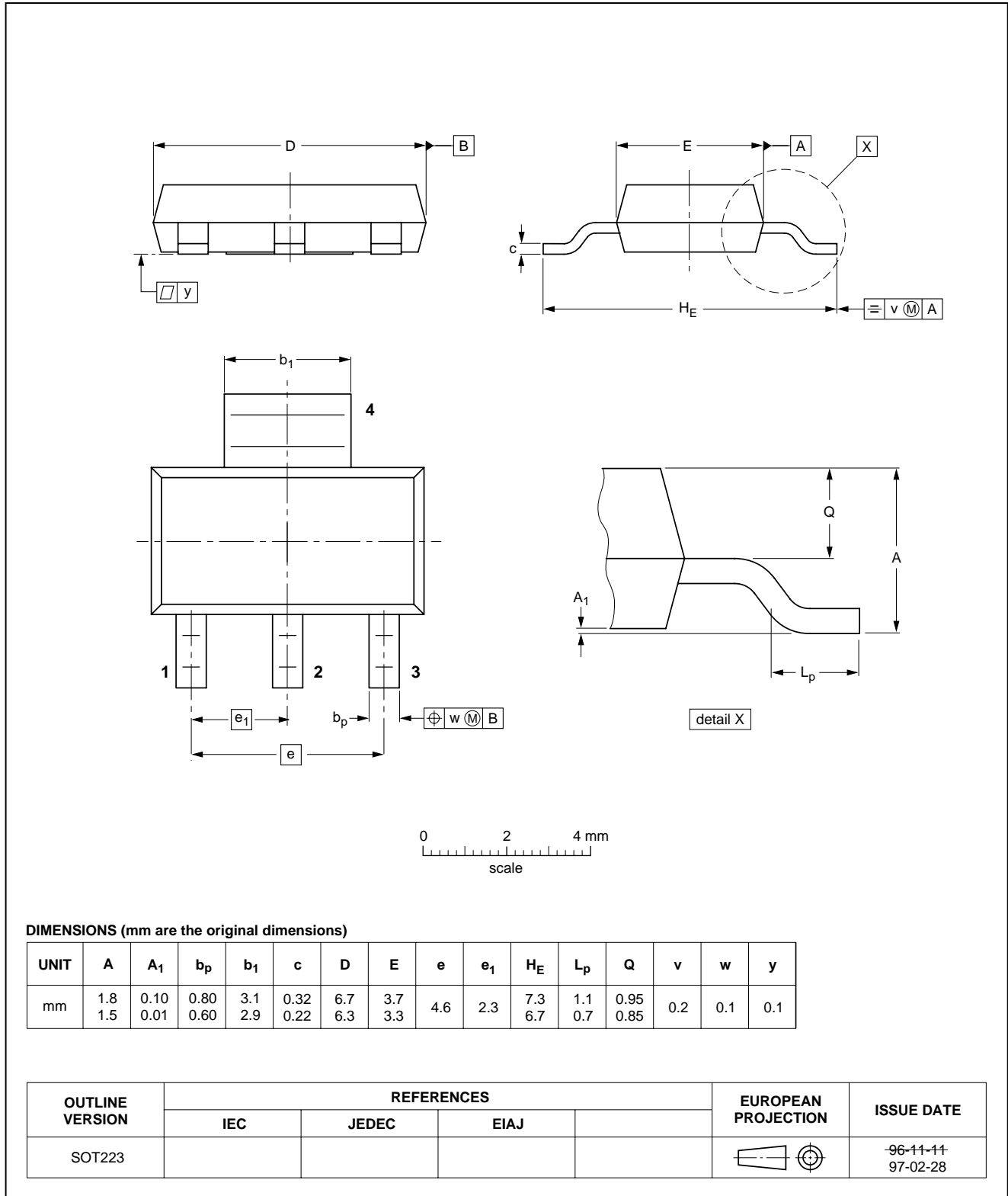

UHF power transistor

BLU86

DEFINITIONS

Data Sheet Status	
Objective specification	This data sheet contains target or goal specifications for product development.
Preliminary specification	This data sheet contains preliminary data; supplementary data may be published later.
Product specification	This data sheet contains final product specifications.
Limiting values	
Limiting values given are in accordance with the Absolute Maximum Rating System (IEC 134). Stress above one or more of the limiting values may cause permanent damage to the device. These are stress ratings only and operation of the device at these or at any other conditions above those given in the Characteristics sections of the specification is not implied. Exposure to limiting values for extended periods may affect device reliability.	
Application information	
Where application information is given, it is advisory and does not form part of the specification.	

LIFE SUPPORT APPLICATIONS

These products are not designed for use in life support appliances, devices, or systems where malfunction of these products can reasonably be expected to result in personal injury. Philips customers using or selling these products for use in such applications do so at their own risk and agree to fully indemnify Philips for any damages resulting from such improper use or sale.