

A large, light blue decorative graphic consisting of a thick, curved line that forms a partial circle, with a small circle at its top end.

LED Driver

BCR401W

Datasheet

Revision 2.0, 2012-04-12

Power Management & Multimarket

Edition 2012-04-12

**Published by
Infineon Technologies AG
81726 Munich, Germany**

**© 2012 Infineon Technologies AG
All Rights Reserved.**

Legal Disclaimer

The information given in this document shall in no event be regarded as a guarantee of conditions or characteristics. With respect to any examples or hints given herein, any typical values stated herein and/or any information regarding the application of the device, Infineon Technologies hereby disclaims any and all warranties and liabilities of any kind, including without limitation, warranties of non-infringement of intellectual property rights of any third party.

Information

For further information on technology, delivery terms and conditions and prices, please contact the nearest Infineon Technologies Office (www.infineon.com).

Warnings

Due to technical requirements, components may contain dangerous substances. For information on the types in question, please contact the nearest Infineon Technologies Office.

Infineon Technologies components may be used in life-support devices or systems only with the express written approval of Infineon Technologies, if a failure of such components can reasonably be expected to cause the failure of that life-support device or system or to affect the safety or effectiveness of that device or system. Life support devices or systems are intended to be implanted in the human body or to support and/or maintain and sustain and/or protect human life. If they fail, it is reasonable to assume that the health of the user or other persons may be endangered.

Revision History

Page or Item	Subjects (major changes since previous revision)
Revision 2.0, 2012-04-12	
All	Datasheet layout updated
Table 2-1	V_{out} limit increased
Table 2-3	R_{int} limits tightened

Trademarks of Infineon Technologies AG

AURIX™, C166™, CanPAK™, CIPOS™, CIPURSE™, EconoPACK™, CoolMOS™, CoolSET™, CORECONTROL™, CROSSAVE™, DAVE™, DI-POL™, EasyPIM™, EconoBRIDGE™, EconoDUAL™, EconoPIM™, EconoPACK™, EiceDRIVER™, eupec™, FCOS™, HITFET™, HybridPACK™, I²RF™, ISOFACE™, IsoPACK™, MIPAQ™, ModSTACK™, my-d™, NovalithIC™, OptiMOS™, ORIGA™, POWERCODE™, PRIMARION™, PrimePACK™, PrimeSTACK™, PRO-SIL™, PROFET™, RASIC™, ReverSave™, SatRIC™, SIEGET™, SINDRION™, SIPMOS™, SmartLEWIS™, SOLID FLASH™, TEMPFET™, thinQ!™, TRENCHSTOP™, TriCore™.

Other Trademarks

Advance Design System™ (ADS) of Agilent Technologies, AMBA™, ARM™, MULTI-ICE™, KEIL™, PRIMECELL™, REALVIEW™, THUMB™, μVision™ of ARM Limited, UK. AUTOSAR™ is licensed by AUTOSAR development partnership. Bluetooth™ of Bluetooth SIG Inc. CAT-iq™ of DECT Forum. COLOSSUS™, FirstGPS™ of Trimble Navigation Ltd. EMV™ of EMVCo, LLC (Visa Holdings Inc.). EPCOS™ of Epcos AG. FLEXGO™ of Microsoft Corporation. FlexRay™ is licensed by FlexRay Consortium. HYPERTERMINAL™ of Hilgraeve Incorporated. IEC™ of Commission Electrotechnique Internationale. IrDA™ of Infrared Data Association Corporation. ISO™ of INTERNATIONAL ORGANIZATION FOR STANDARDIZATION. MATLAB™ of MathWorks, Inc. MAXIM™ of Maxim Integrated Products, Inc. MICROTEC™, NUCLEUS™ of Mentor Graphics Corporation. MIPI™ of MIPI Alliance, Inc. MIPS™ of MIPS Technologies, Inc., USA. muRata™ of MURATA MANUFACTURING CO., MICROWAVE OFFICE™ (MWO) of Applied Wave Research Inc., OmniVision™ of OmniVision Technologies, Inc. Openwave™ Openwave Systems Inc. RED HAT™ Red Hat, Inc. RFMD™ RF Micro Devices, Inc. SIRIUS™ of Sirius Satellite Radio Inc. SOLARIS™ of Sun Microsystems, Inc. SPANSION™ of Spansion LLC Ltd. Symbian™ of Symbian Software Limited. TAIYO YUDEN™ of Taiyo Yuden Co. TEAKLITE™ of CEVA, Inc. TEKTRONIX™ of Tektronix Inc. TOKO™ of TOKO KABUSHIKI KAISHA TA. UNIX™ of X/Open Company Limited. VERILOG™, PALLADIUM™ of Cadence Design Systems, Inc. VLYNQ™ of Texas Instruments Incorporated. VXWORKS™, WIND RIVER™ of WIND RIVER SYSTEMS, INC. ZETEX™ of Diodes Zetex Limited.

Last Trademarks Update 2011-11-11

Table of Contents

	Table of Contents	4
	List of Figures	5
	List of Tables	6
1	LED Driver	7
1.1	Features	7
1.2	Applications	7
1.3	General Description	7
2	Electrical Characteristics	9
3	Typical characteristics	10
4	Application hints	14
5	Package	15
	Terminology	16

List of Figures

Figure 1-1	Pin configuration and typical application.	8
Figure 3-1	Total Power Dissipation $P_{tot} = f(T_S)$	10
Figure 3-2	Permissible Pulse Load $R_{thJS} = f(t_p)$	10
Figure 3-3	Permissible Pulse Load $P_{totmax} / P_{totDC} = f(t_p)$	11
Figure 3-4	Output Current versus $V_S I_{out} = f(V_S)$, 2 LEDs load with $V_F = 3.8V$ in series, $R_{ext} =$ Parameter.	12
Figure 3-5	Supply Current versus $V_S I_S = f(V_S)$, 2 LEDs load with $V_F = 3.8V$ in series.	12
Figure 3-6	Output Current versus $R_{ext} I_{out} = f(R_{ext})$, $V_S = 10 V$, $V_{out} = 7.6 V$	13
Figure 3-7	Output Current versus $V_{drop} I_{out} = f(V_{drop})$, $V_S = 10 V$, $V_{out} = 7.6 V$	13
Figure 4-1	Application Circuit: Stand alone current source	14
Figure 4-2	Application Circuit: Supply voltages > 18 V	14
Figure 5-1	Package Outline for SOT343 (dimensions in mm)	15
Figure 5-2	Package Footprint for SOT343 (dimensions in mm).	15
Figure 5-3	Tape and Reel Information for SOT343 (dimensions in mm).	15

List of Tables

Table 2-1	Maximum Ratings at $T_A = 25\text{ °C}$, unless otherwise specified	9
Table 2-2	Thermal Resistance at $T_A = 25\text{ °C}$, unless otherwise specified	9
Table 2-3	Electrical Characteristics at $T_A = 25\text{ °C}$, unless otherwise specified	9
Table 2-4	DC Characteristics with stabilized LED load at $T_A = 25\text{ °C}$, unless otherwise specified	9

1 LED Driver

1.1 Features

- LED drive current preset to 10 mA
- Output current adjustable up to 60 mA with an external resistor
- Easy paralleling of drivers to increase current
- Supply voltage up to 18 V
- High current accuracy at supply voltage variation
- Low voltage overhead of 1.2 V
- Up to 500 mW power dissipation in a small SOT343 package
- Negative thermal coefficient of -0.3 %/K reduces output current at higher temperatures
- RoHS compliant (Pb-free) package
- Automotive qualified according AEC Q101



SOT343-3D



1.2 Applications

- Channel letters for advertising, LED strips for decorative lighting
- Aircraft, train, ship illumination
- Retrofits for general lighting, white goods like refrigerator lighting
- Medical lighting
- Automotive applications like CHMSL and rear combination lights

1.3 General Description

The BCR401W is a cost efficient LED driver to drive low power LEDs. The advantages towards resistor biasing are:

- homogenous light output despite of varying forward voltages in different LED strings
- homogenous light output of LEDs despite of voltage drop across long supply lines
- homogenous light output independent from supply voltage variations
- longer lifetime of the LEDs due to reduced output current at higher temperatures (negative thermal coefficient)

The advantages towards discrete solutions are:

- lower assembly cost
- smaller form factor
- higher reliability due to less soldering joints
- higher output current accuracy due to pretested LED drivers

Dimming is possible by using an external digital transistor at the ground pin.

The BCR401W can be operated at higher supply voltages adding LEDs between the supply voltage V_S and the power supply pin of the LED driver. You can find further details in our application notes.

The BCR401W is a perfect fit for numerous low power LED applications by combining small form factor with low cost. These LED drivers offer several advantages to resistors like significantly higher current control at very low voltage drop ensuring high lifetime of the LEDs.

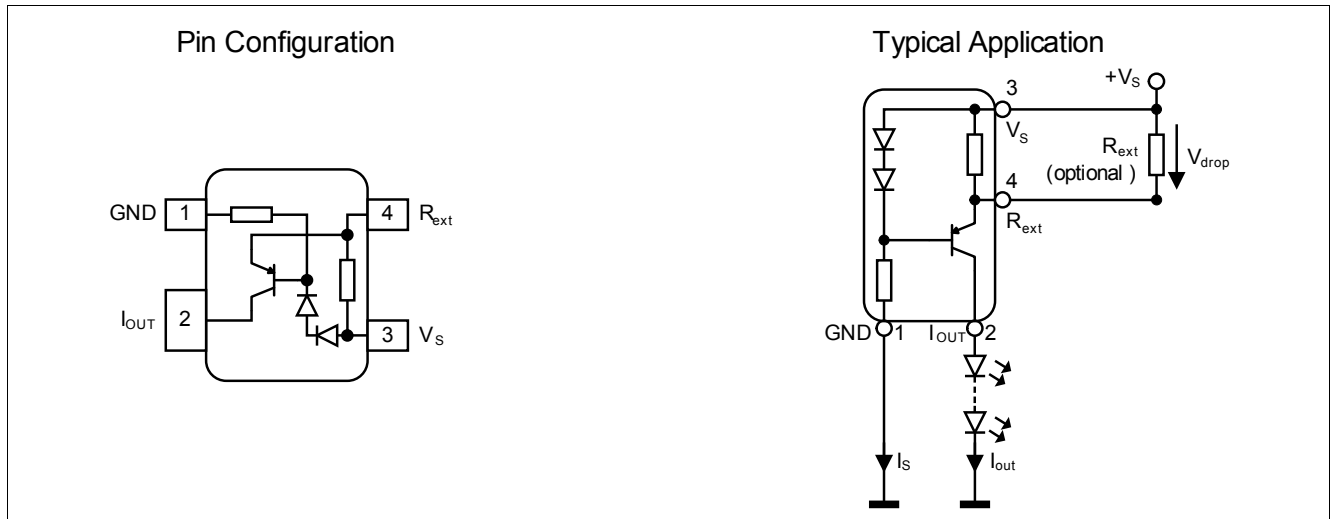

Figure 1-1 Pin configuration and typical application

Type	Marking	Pin Configuration				Package
		1 = GND	2 = I _{OUT}	3 = V _S	4 = R _{ext}	
BCR401W	W5s	1 = GND	2 = I _{OUT}	3 = V _S	4 = R _{ext}	SOT343

2 Electrical Characteristics

Table 2-1 Maximum Ratings at $T_A = 25\text{ °C}$, unless otherwise specified

Parameter	Symbol	Values			Unit	Note / Test Condition
		Min.	Typ.	Max.		
Supply voltage	V_S	-	-	18	V	
Output current	I_{out}	-	-	60	mA	
Output voltage	V_{out}	-	-	18	V	
Reverse voltage between all terminals	V_R	-	-	0.5	V	
Total power dissipation	P_{tot}	-	-	500	mW	$T_S \leq 95\text{ °C}$
Junction temperature	T_J	-	-	150	°C	
Storage temperature range	T_{STG}	-65	-	150	°C	

Attention: Stresses above the max. values listed here may cause permanent damage to the device. Exposure to absolute maximum rating conditions for extended periods may affect device reliability. Maximum ratings are absolute ratings; exceeding only one of these values may cause irreversible damage to the integrated circuit.

Table 2-2 Thermal Resistance at $T_A = 25\text{ °C}$, unless otherwise specified

Parameter	Symbol	Values			Unit	Note / Test Condition
		Min.	Typ.	Max.		
Junction - soldering point ¹⁾	R_{thJS}	-	-	110	K/W	

1) For calculation of R_{thJA} please refer to Application Note AN077 (Thermal Resistance Calculation)

Table 2-3 Electrical Characteristics at $T_A = 25\text{ °C}$, unless otherwise specified

Parameter	Symbol	Values			Unit	Note / Test Condition
		Min.	Typ.	Max.		
Collector-emitter breakdown voltage	$V_{BR(CEO)}$	18	-	-	V	$I_C = 100\text{ }\mu\text{A}$, $I_B = 0$
Supply current	I_S	350	440	540	μA	$V_S = 10\text{ V}$
DC current gain	h_{FE}	-	150	-	-	$I_C = 50\text{ mA}$, $V_{CE} = 1\text{ V}$
Internal resistor	R_{int}	68	79	90	Ω	$I_{Rint} = 10\text{ mA}$
Output current	I_{out}	9	10	11	mA	$V_S = 10\text{ V}$ $V_{out} = 7.6\text{ V}$
Voltage drop (V_{Rext})	V_{drop}	-	0.79	-	V	$I_{out} = 10\text{ mA}$

Table 2-4 DC Characteristics with stabilized LED load at $T_A = 25\text{ °C}$, unless otherwise specified

Parameter	Symbol	Values			Unit	Note / Test Condition
		Min.	Typ.	Max.		
Lowest sufficient supply voltage overhead	V_{Smin}	-	1.2	-	V	$I_{out} > 8\text{ mA}$
Output current change versus T_A	$\Delta I_{out}/I_{out}$	-	-0.3	-	%/K	$V_S = 10\text{ V}$
Output current change versus V_S	$\Delta I_{out}/I_{out}$	-	2	-	%/V	$V_S = 10\text{ V}$

3 Typical characteristics

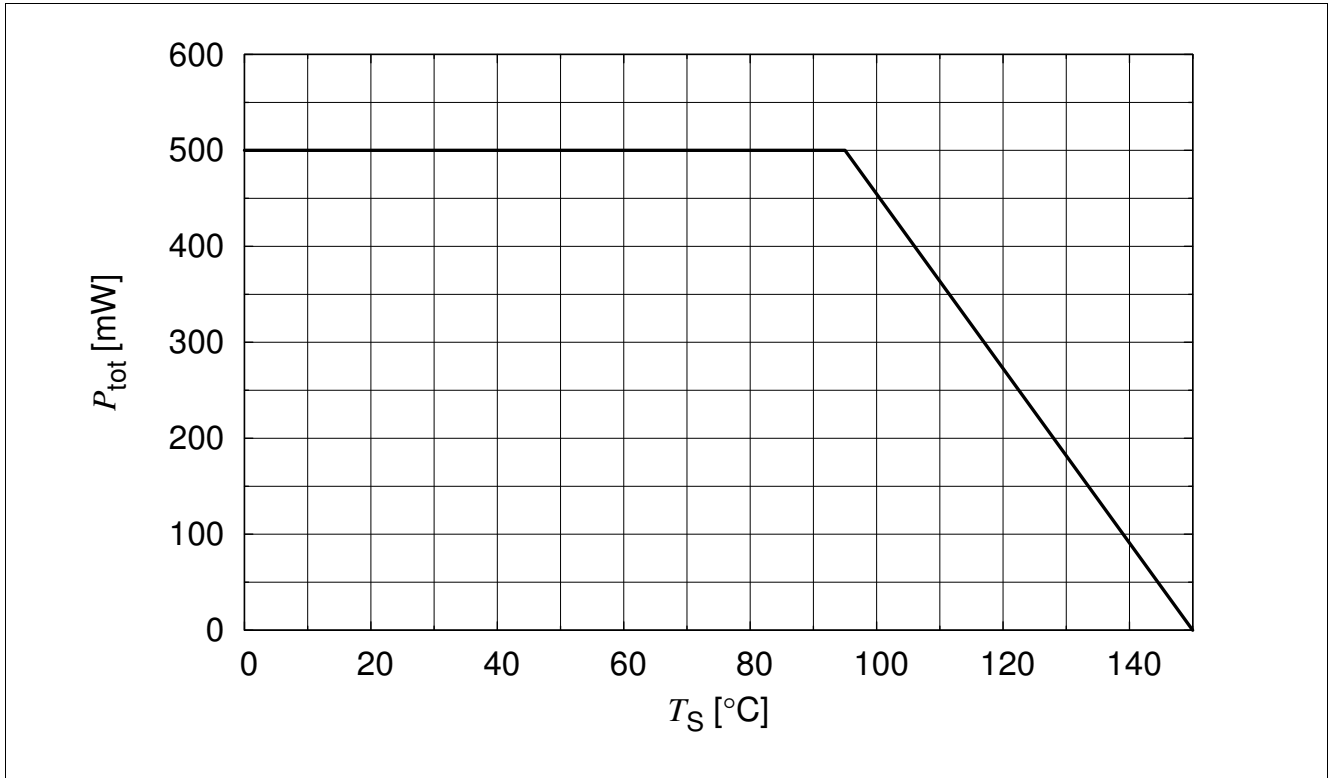

Figure 3-1 Total Power Dissipation $P_{tot} = f(T_S)$

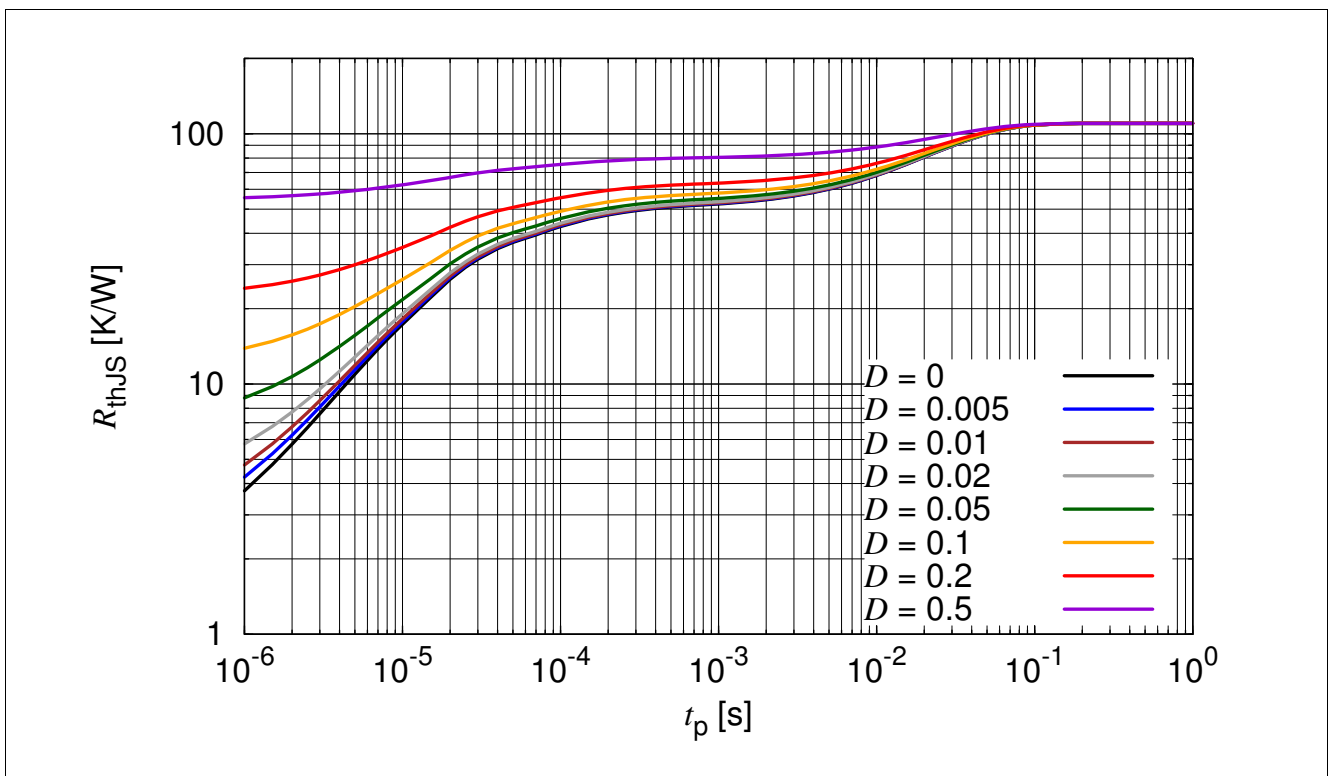

Figure 3-2 Permissible Pulse Load $R_{thJS} = f(t_p)$

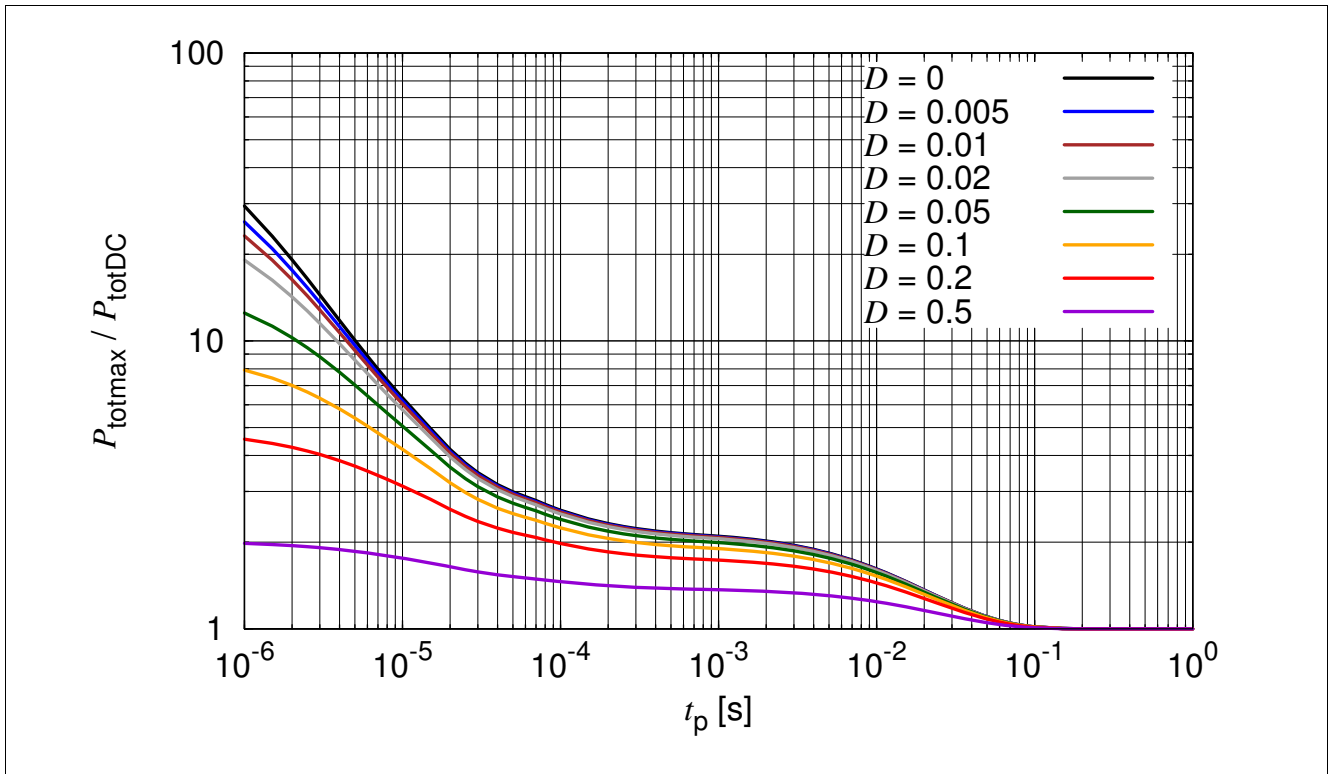

Figure 3-3 Permissible Pulse Load $P_{totmax} / P_{totDC} = f(t_p)$

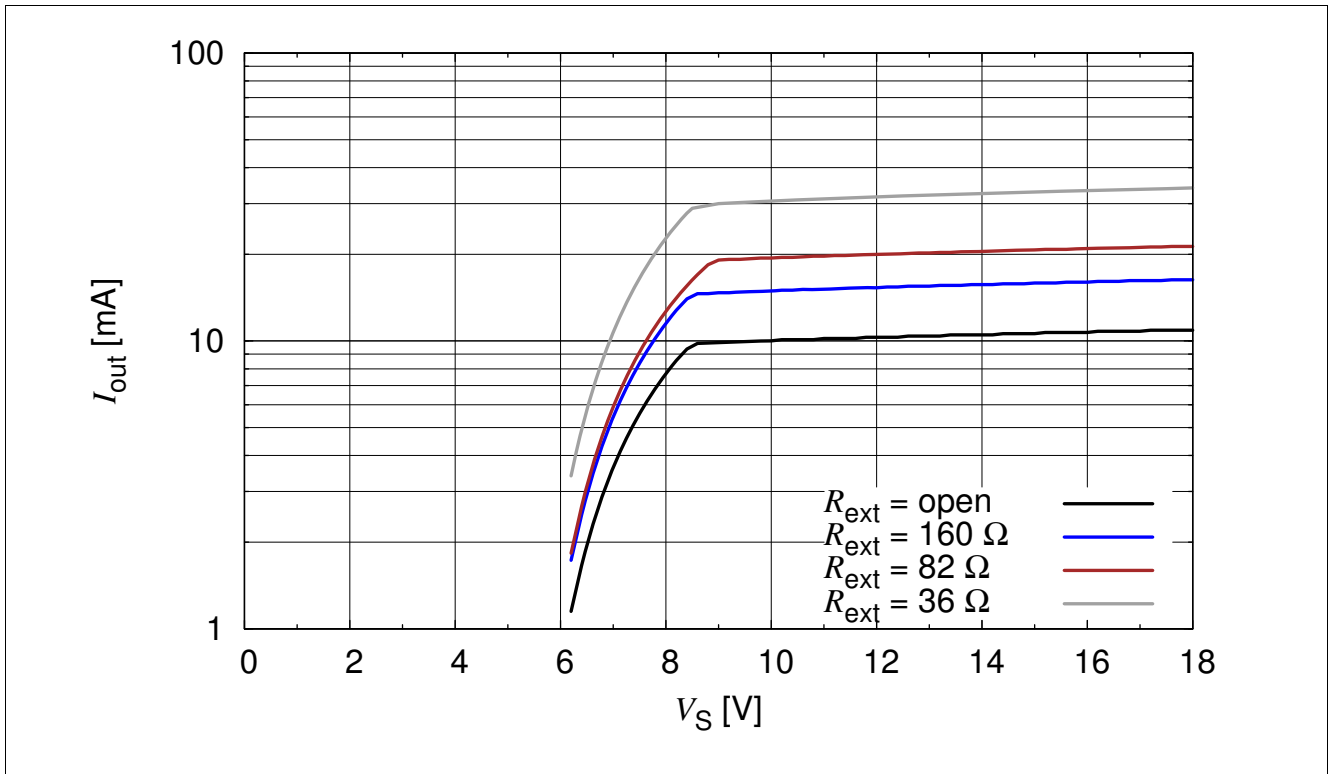

Figure 3-4 Output Current versus V_S $I_{out} = f(V_S)$, 2 LEDs load with $V_F = 3.8V$ in series, $R_{ext} = \text{Parameter}$

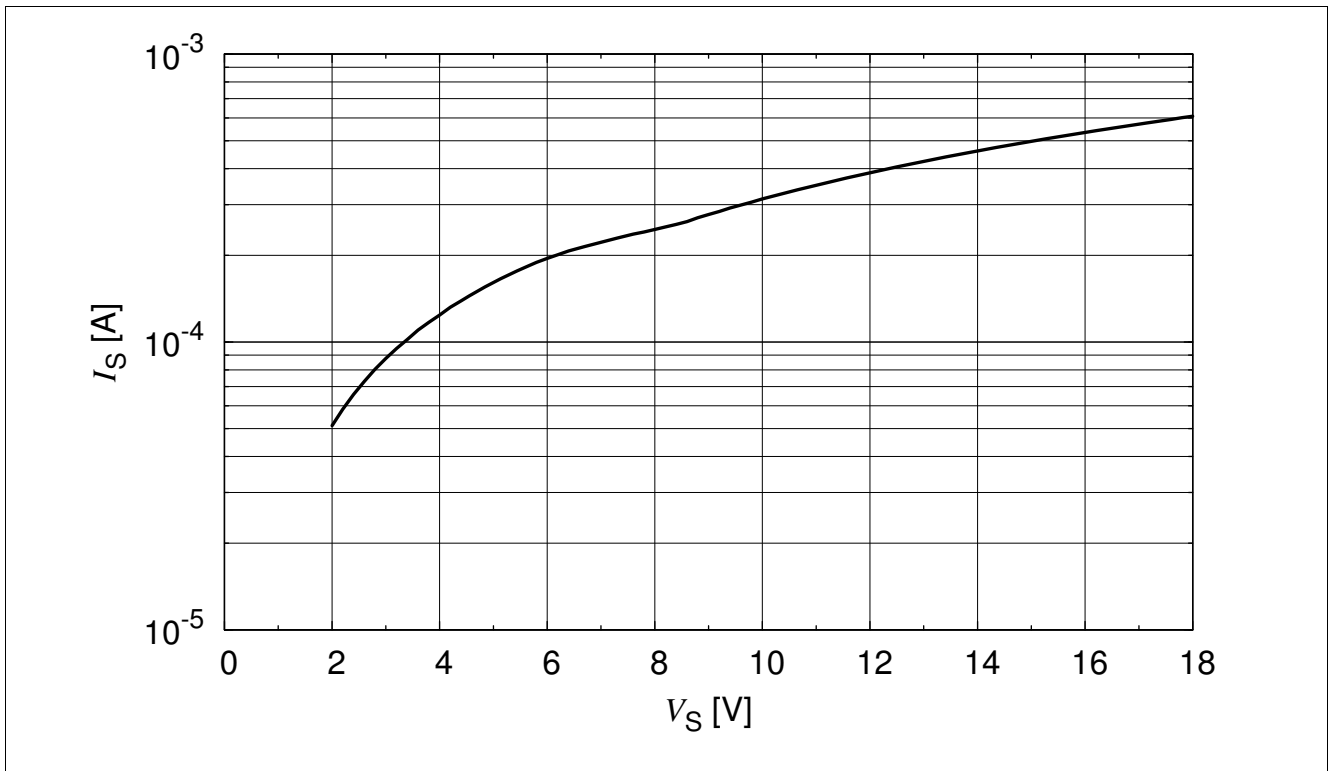

Figure 3-5 Supply Current versus V_S $I_S = f(V_S)$, 2 LEDs load with $V_F = 3.8V$ in series

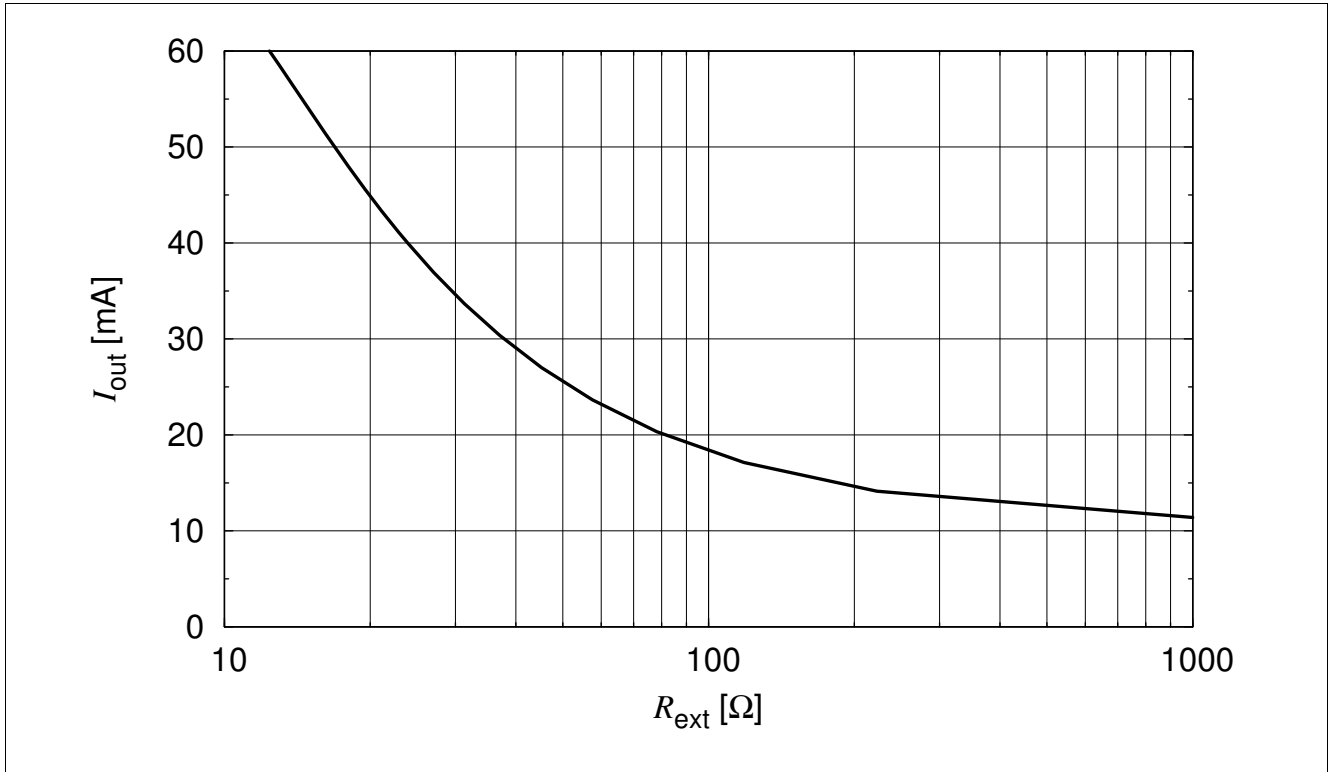

Figure 3-6 Output Current versus R_{ext} $I_{out} = f(R_{ext})$, $V_S = 10\text{ V}$, $V_{out} = 7.6\text{ V}$

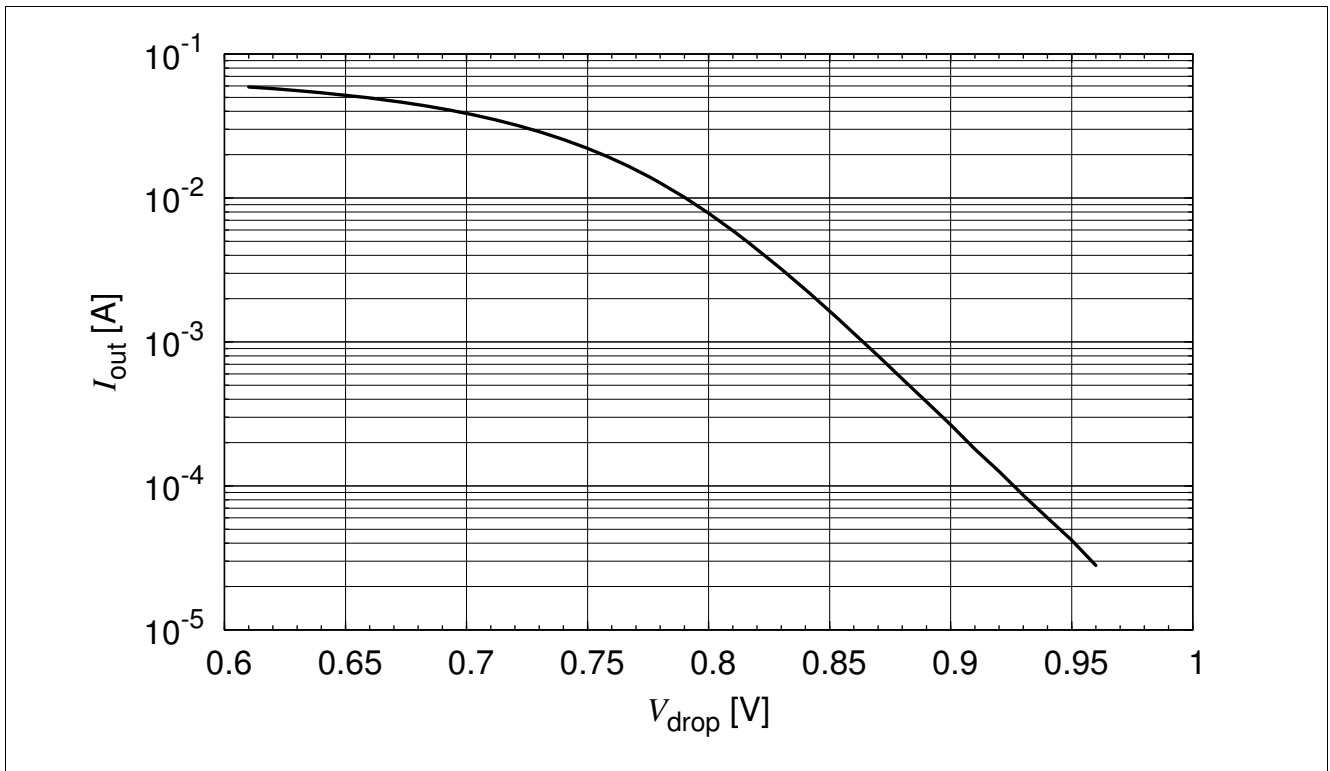

Figure 3-7 Output Current versus V_{drop} $I_{out} = f(V_{drop})$, $V_S = 10\text{ V}$, $V_{out} = 7.6\text{ V}$

4 Application hints

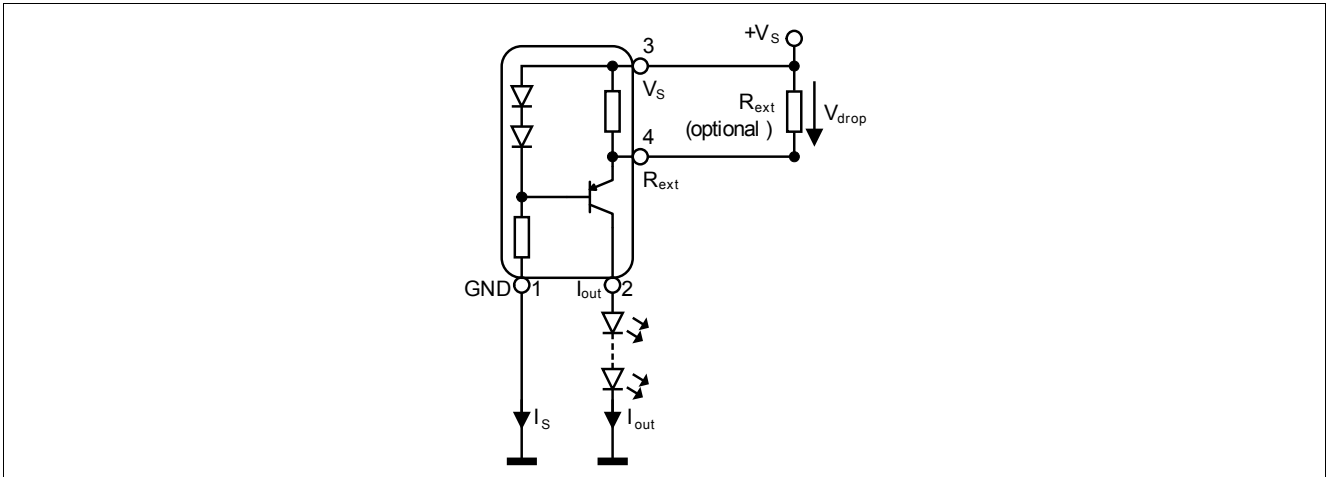

Figure 4-1 Application Circuit: Stand alone current source

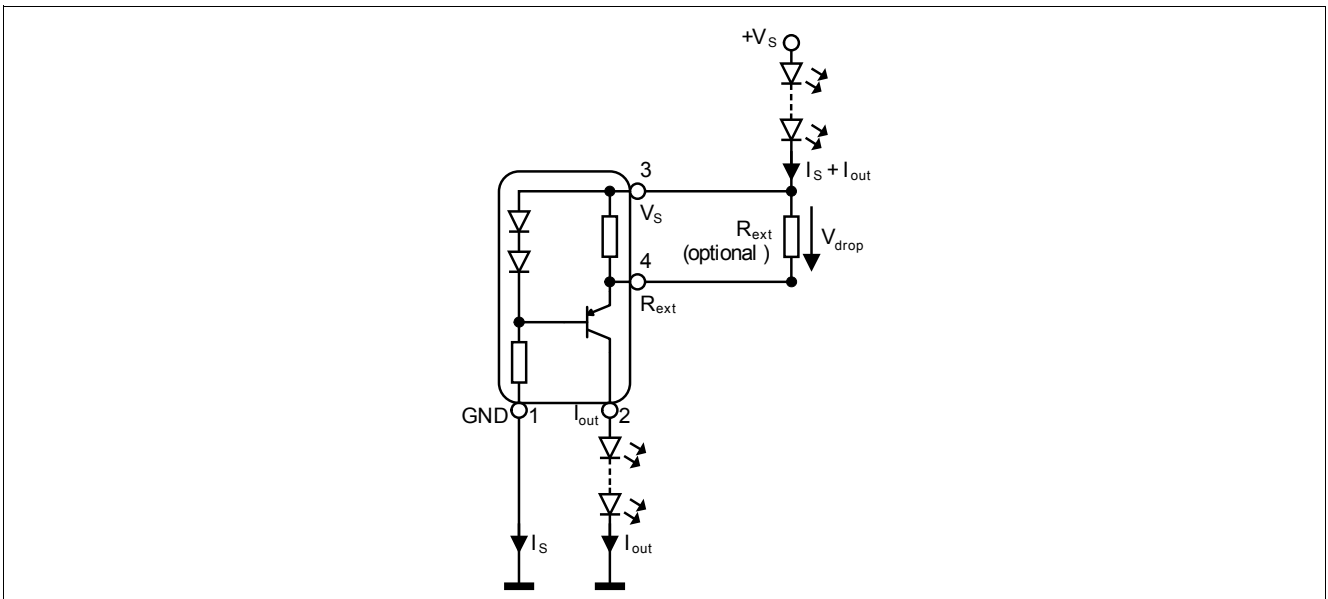

Figure 4-2 Application Circuit: Supply voltages > 18 V

Application hints

BCR401W serves as an easy to use constant current source for LEDs. In stand alone application an external resistor R_{ext} can be connected to adjust the current between 10 mA and 60 mA. R_{ext} can be determined by using [Figure 3-6](#). Connecting a low tolerance resistor R_{ext} will improve the overall accuracy of the current sense resistance formed by the parallel connection of R_{int} and R_{ext} leading to an improved current accuracy. Please take into account that the resulting output currents will be slightly lower due to the self heating of the component and the negative thermal coefficient.

Please visit our web site www.infineon.com/lowcostledriver for detailed application notes.

5 Package

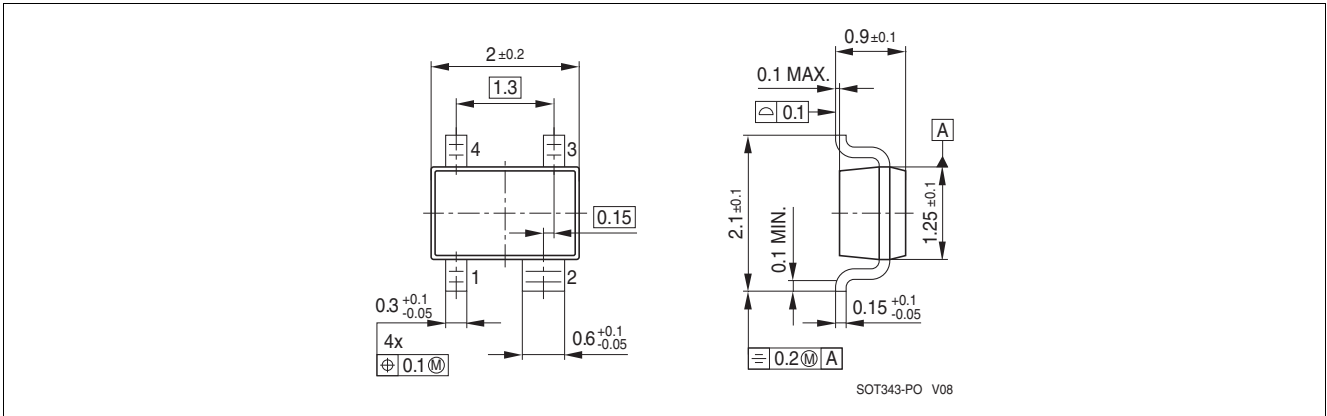

Figure 5-1 Package Outline for SOT343 (dimensions in mm)

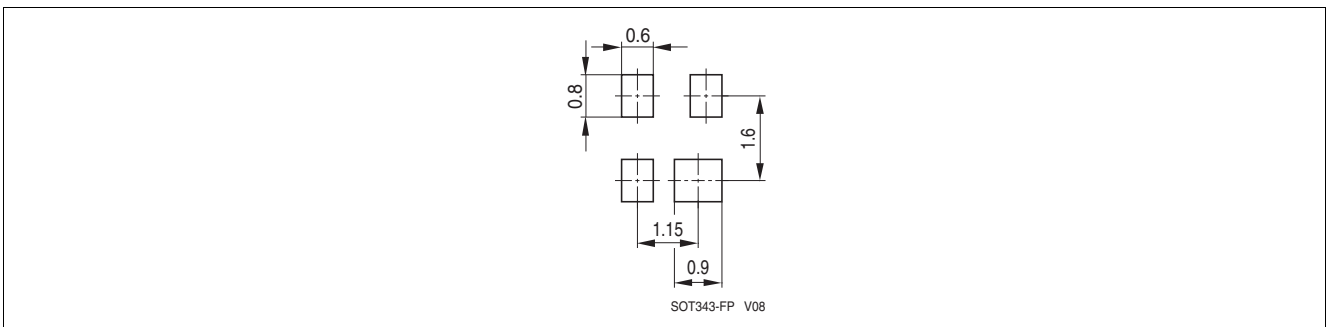

Figure 5-2 Package Footprint for SOT343 (dimensions in mm)

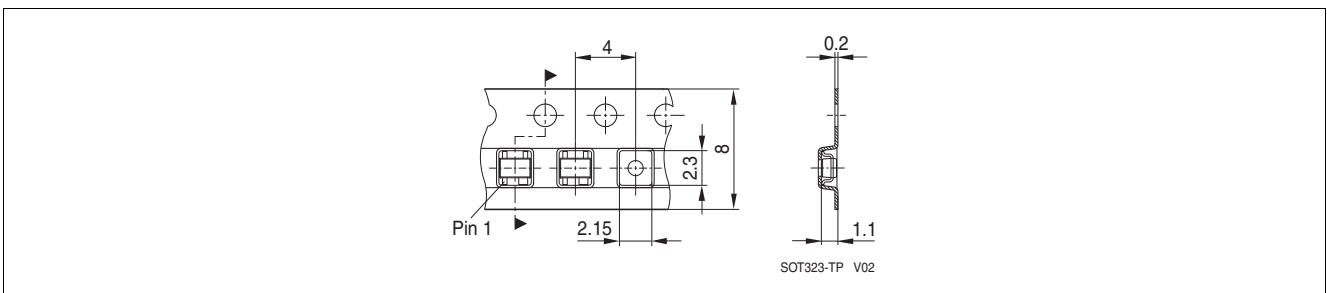

Figure 5-3 Tape and Reel Information for SOT343 (dimensions in mm)

Terminology

$\Delta I_{out}/I_{out}$	Output current change
h_{FE}	DC current gain
I_{EN}	Enable current
I_{LED}	LED current
I_{out}	Output current
I_R	Reverse current
LED	Light Emitting Diode
PCB	Printed Circuit Board
P_{tot}	Total power dissipation
PWM	Pulse Width Modulation
R_B	Bias resistor
R_{ext}	External resistor
R_{int}	Internal resistor
RoHs	Restriction of Hazardous Substance directive
R_{thJS}	Thermal resistance junction to soldering point
T_A	Ambient temperature
T_J	Junction temperature
T_S	Soldering point temperature
T_{stg}	Storage temperature
$V_{BR(CEO)}$	Collector-emitter breakdown voltage
V_{BR}	Breakdown voltage
V_{drop}	Voltage drop
V_{out}	Output voltage
V_R	Reverse voltage
V_S	Supply voltage
V_{Smin}	Lowest sufficient supply voltage overhead

www.infineon.com

Published by Infineon Technologies AG