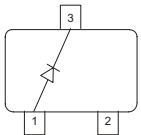
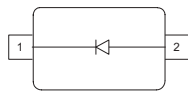
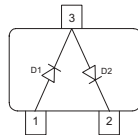
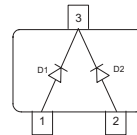
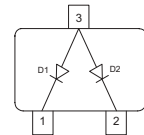

**Silicon Schottky Diodes**

- For low-loss, fast-recovery, meter protection, bias isolation and clamping application
- Integrated diffused guard ring
- Low forward voltage
- Pb-free (RoHS compliant) package <sup>1)</sup>
- Qualified according AEC Q101

**BAT64**

**BAT64-02W**

**BAT64-04  
BAT64-04W**

**BAT64-05  
BAT64-05W**

**BAT64-06  
BAT64-06W**

**ESD (Electrostatic discharge) sensitive device, observe handling precaution!**

Type	Package	Configuration	$L_S$ (nH)	Marking
BAT64	SOT23	single	1.8	63s
BAT64-02W	SCD80	single	0.6	64
BAT64-04	SOT23	series	1.8	64s
BAT64-04W	SOT323	series	1.4	64s
BAT64-05	SOT23	common cathode	1.8	65s
BAT64-05W	SOT323	common cathode	1.4	65s
BAT64-06	SOT23	common anode	1.8	66s
BAT64-06W	SOT323	common anode	1.4	66s

<sup>1</sup>Pb-containing package may be available upon special request

**Maximum Ratings at  $T_A = 25^\circ\text{C}$ , unless otherwise specified**

Parameter	Symbol	Value	Unit
Diode reverse voltage	$V_R$	40	V
Forward current	$I_F$	250	mA
Non-repetitive peak surge forward current ( $t \leq 10\text{ms}$ )	$I_{FSM}$	800	
Average rectified forward current (50/60Hz, sinus)	$I_{FAV}$	120	
Total power dissipation	$P_{tot}$		mW
BAT64, $T_S \leq 86^\circ\text{C}$		250	
BAT64-02W, $T_S \leq 121^\circ\text{C}$		250	
BAT64-04, BAT64-06, $T_S \leq 61^\circ\text{C}$		250	
BAT64-04W, BAT64-06W, $T_S \leq 111^\circ\text{C}$		250	
BAT64-05, $T_S \leq 36^\circ\text{C}$		250	
BAT64-05W, $T_S \leq 104^\circ\text{C}$		250	
Junction temperature	$T_j$	150	$^\circ\text{C}$
Storage temperature	$T_{stg}$	-55 ... 150	

**Thermal Resistance**

Parameter	Symbol	Value	Unit
Junction - soldering point <sup>1)</sup>	$R_{thJS}$		K/W
BAT64		$\leq 255$	
BAT64-02W		$\leq 115$	
BAT64-04, BAT64-06,		$\leq 355$	
BAT64-04W, BAT64-06W		$\leq 155$	
BAT64-05		$\leq 455$	
BAT64-05W		$\leq 185$	

<sup>1</sup>For calculation of  $R_{thJA}$  please refer to Application Note Thermal Resistance

**Electrical Characteristics at  $T_A = 25^\circ\text{C}$ , unless otherwise specified**

Parameter	Symbol	Values			Unit
		min.	typ.	max.	
<b>DC Characteristics</b>					
Breakdown voltage $I_{(BR)} = 10 \mu\text{A}$	$V_{(BR)}$	40	-	-	V
Reverse current $V_R = 30 \text{ V}$ $V_R = 30 \text{ V}, T_A = 85^\circ\text{C}$	$I_R$	-	-	2 200	$\mu\text{A}$
Forward voltage $I_F = 1 \text{ mA}$ $I_F = 10 \text{ mA}$ $I_F = 30 \text{ mA}$ $I_F = 100 \text{ mA}$	$V_F$	270 310 370 500	320 385 440 570	350 430 520 750	mV
<b>AC Characteristics</b>					
Diode capacitance $V_R = 1 \text{ V}, f = 1 \text{ MHz}$	$C_T$	-	4	6	pF
Reverse recovery time $I_F = 10 \text{ mA}, I_R = 10 \text{ mA}, \text{measured } I_R = 1 \text{ mA},$ $R_L = 100 \Omega$	$t_{rr}$	-	-	5	ns

**Diode capacitance  $C_T = f(V_R)$**

$f = 1\text{MHz}$

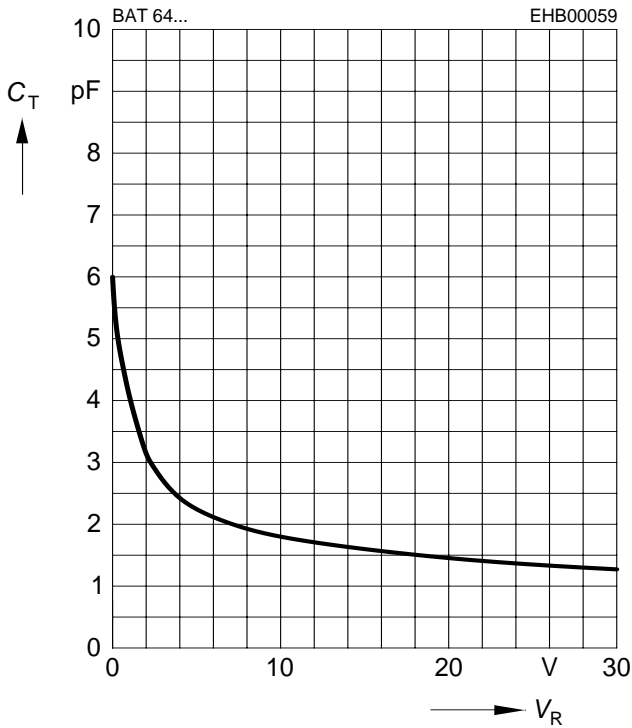

**Reverse current  $I_R = f(V_R)$**

$T_A = \text{Parameter}$

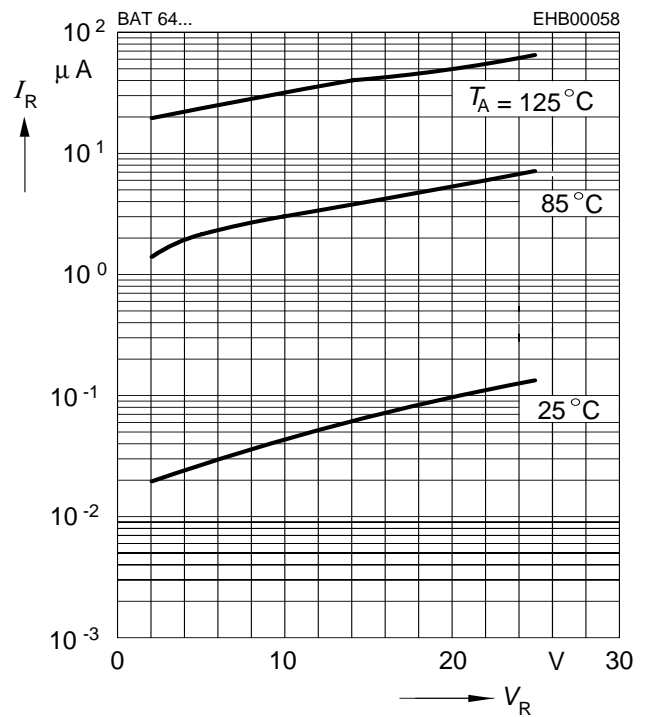

**Forward current  $I_F = f(V_F)$**

$T_A = \text{Parameter}$

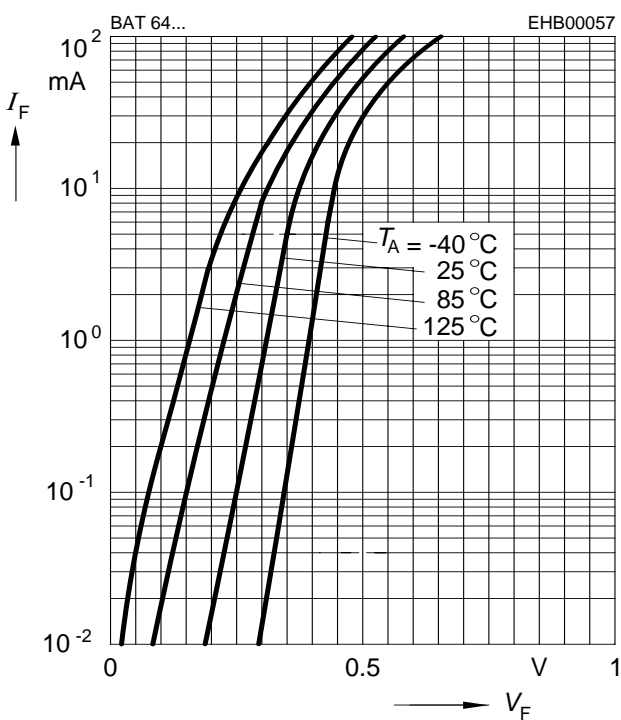

**Forward current  $I_F = f(T_S)$**

BAT64W

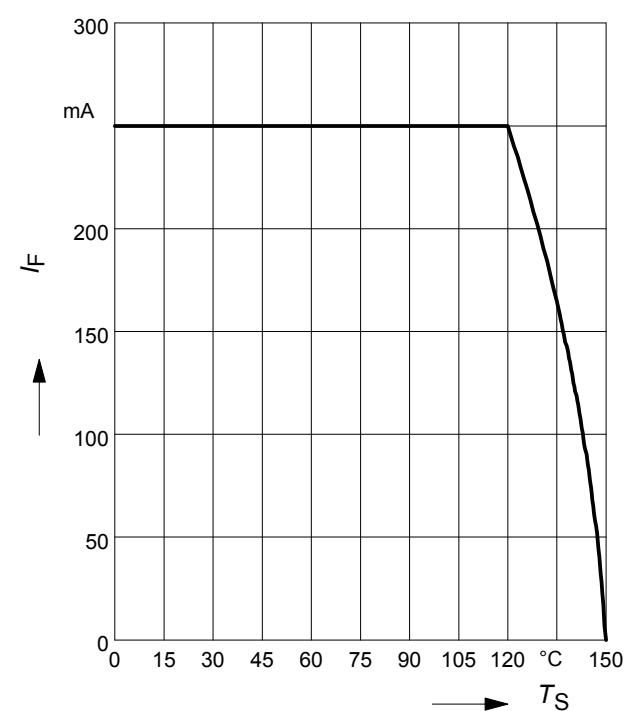

Forward current  $I_F = f(T_S)$

BAT64-02W

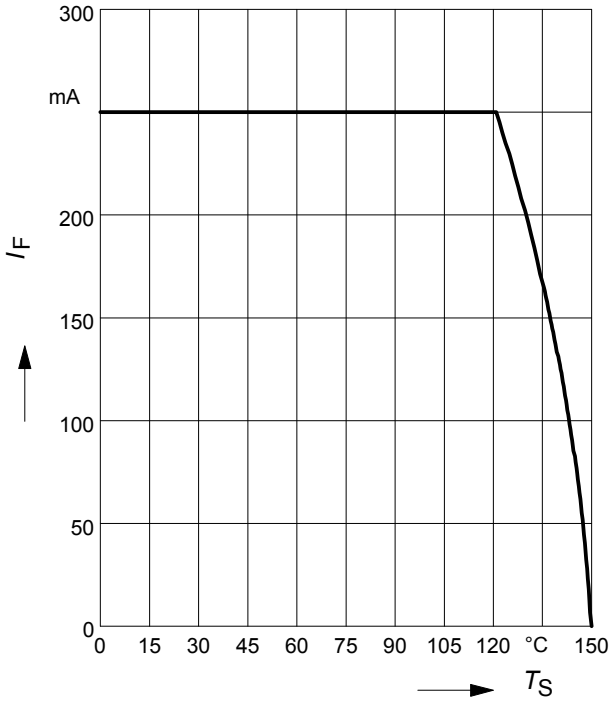

Forward current  $I_F = f(T_S)$

BAT64-04, BAT64-06

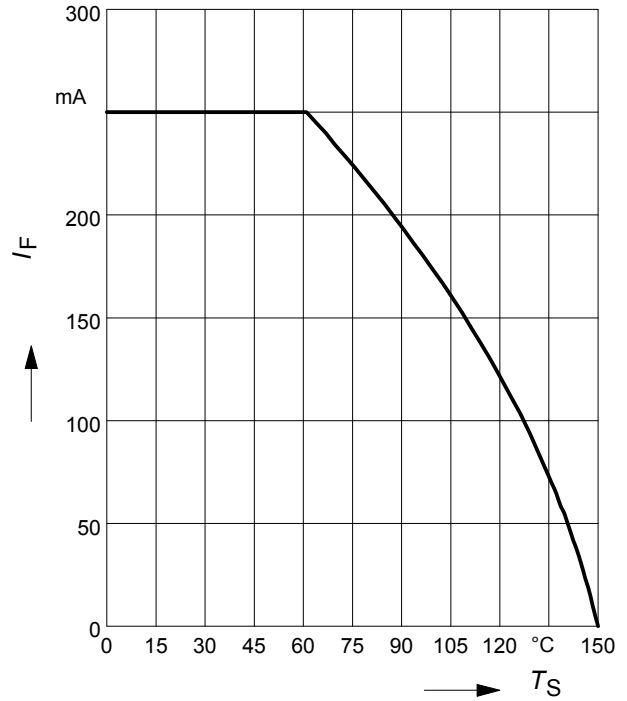

Forward current  $I_F = f(T_S)$

BAT64-04W, BAT64-06W

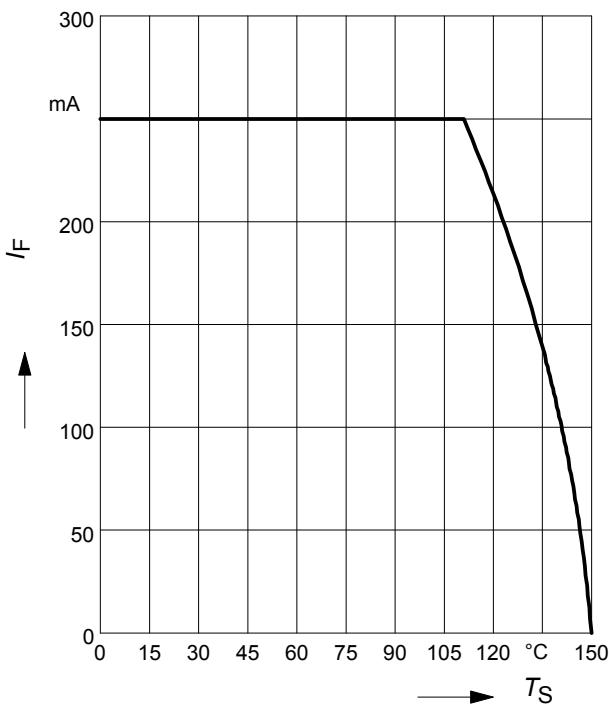

Forward current  $I_F = f(T_S)$

BAT64-05

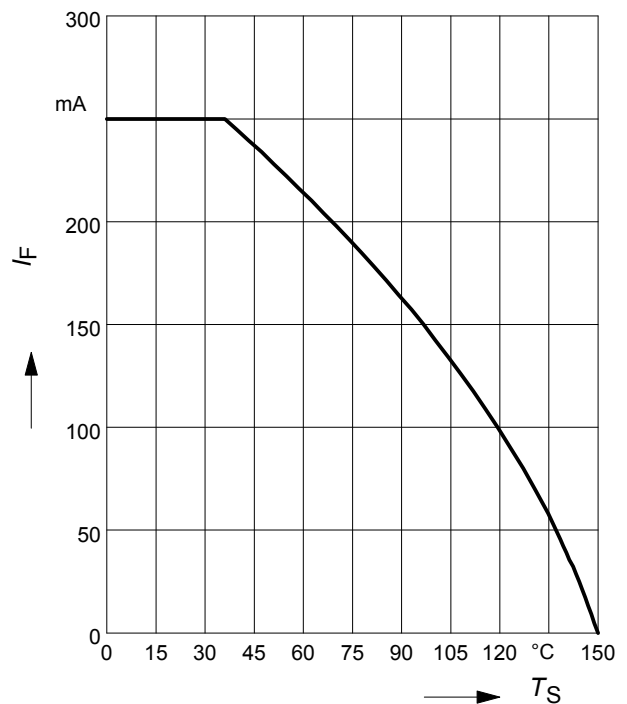

**Forward current  $I_F = f(T_S)$**

BAT64-05W

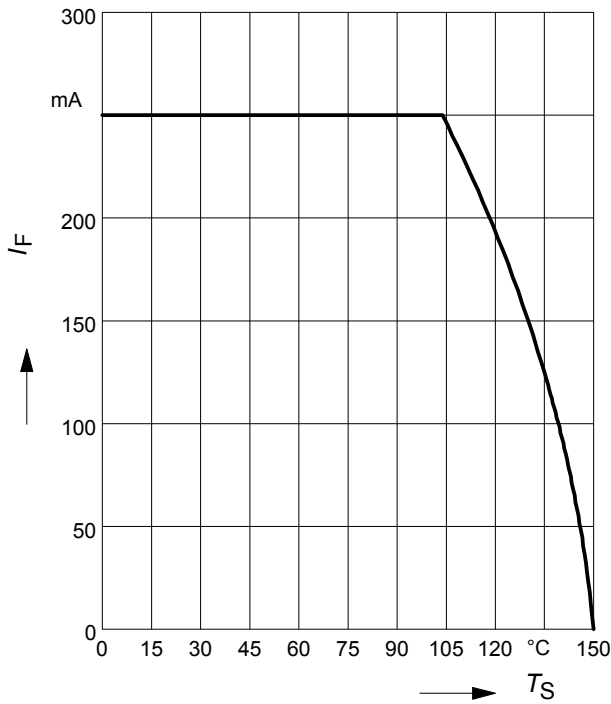

**Permissible Puls Load  $R_{thJS} = f(t_p)$**

BAT64-02W

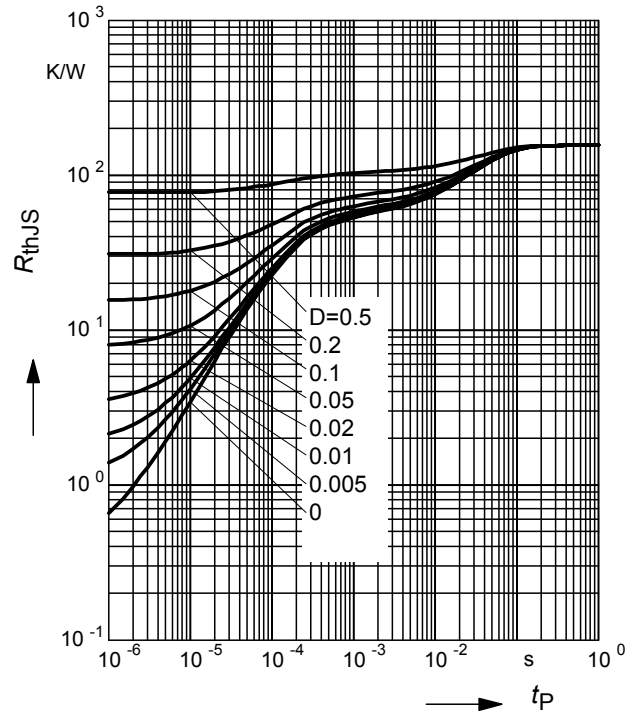

**Permissible Pulse Load**

$I_{Fmax} / I_{FDC} = f(t_p)$

BAT64-02W

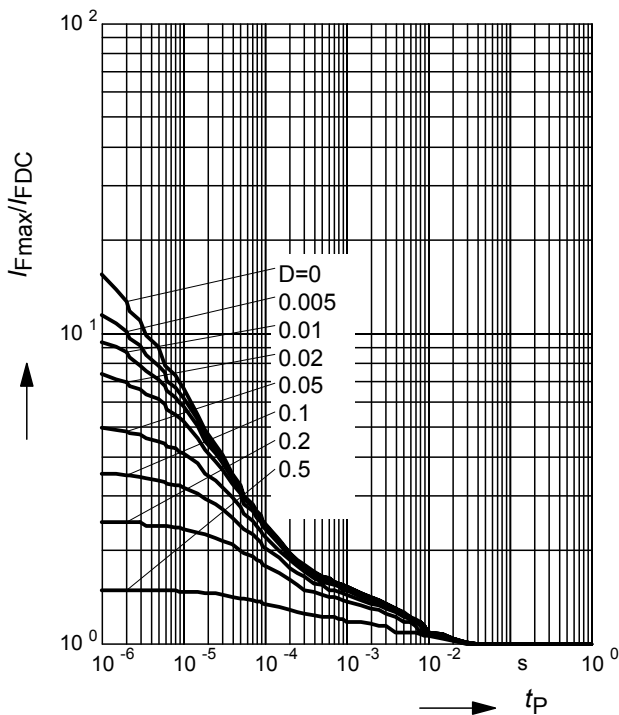

**Permissible Puls Load  $R_{thJS} = f(t_p)$**

BAT64-04W, BAT64-06W

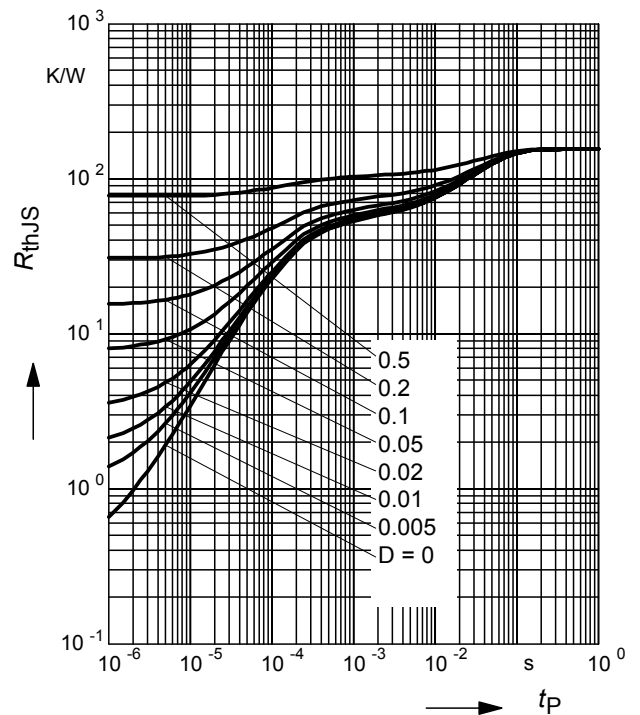

**Permissible Pulse Load**

$$I_{Fmax} / I_{FDC} = f(t_p)$$

BAT64-04W, BAT64-06W

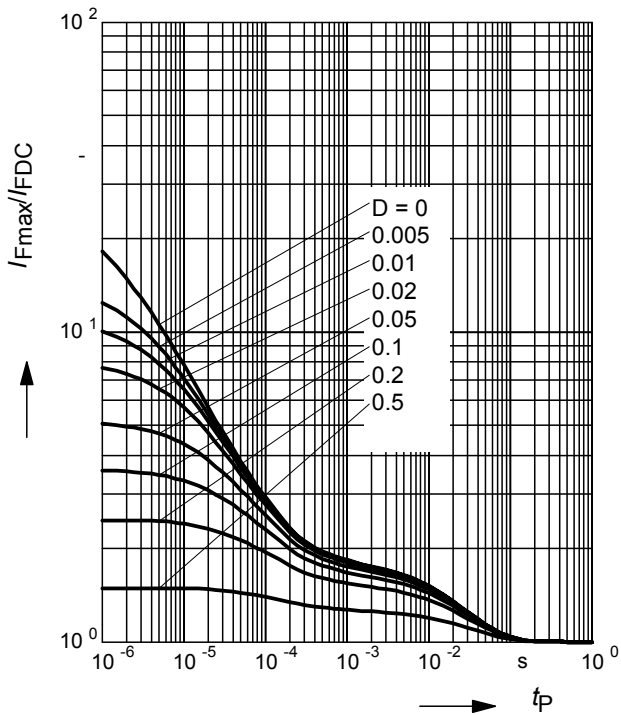

**Permissible Puls Load  $R_{thJS} = f(t_p)$**

BAT64-05W

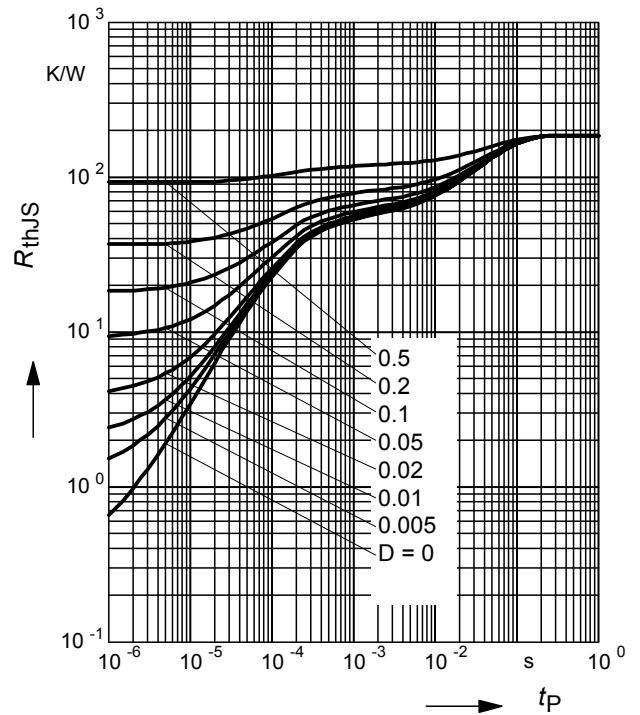

**Permissible Pulse Load**

$$I_{Fmax} / I_{FDC} = f(t_p)$$

BAT64-05W

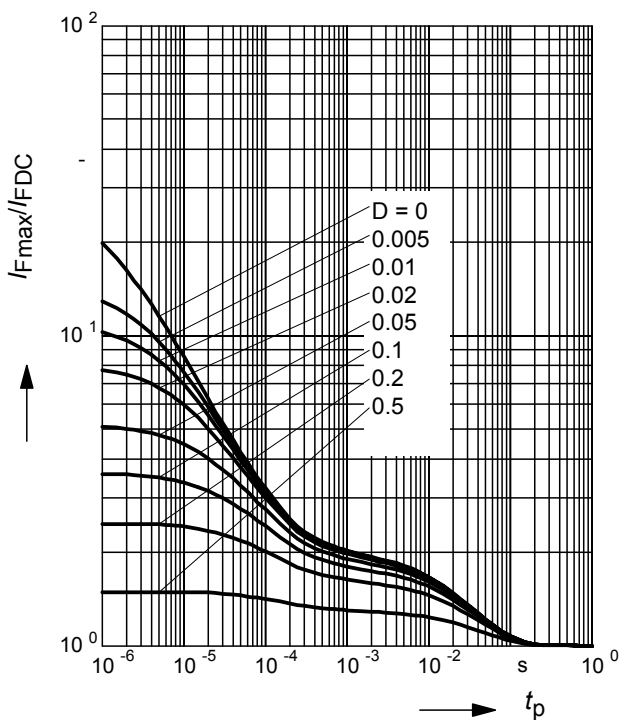

Package Outline

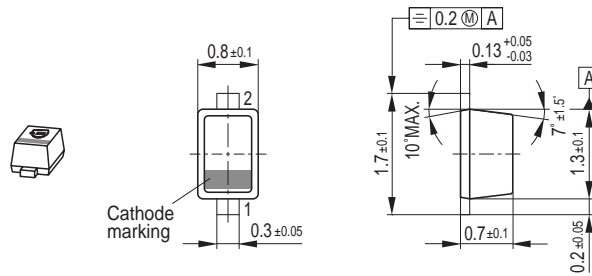

Foot Print

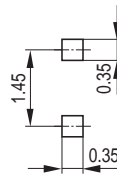

Marking Layout (Example)

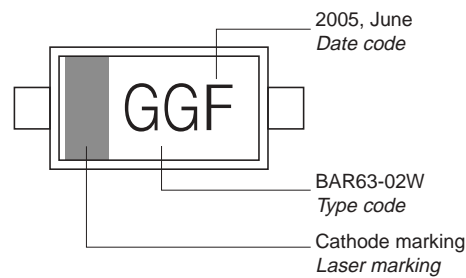

Standard Packing

Reel ø180 mm = 3.000 Pieces/Reel  
 Reel ø180 mm = 8.000 Pieces/Reel (2 mm Pitch)  
 Reel ø330 mm = 10.000 Pieces/Reel

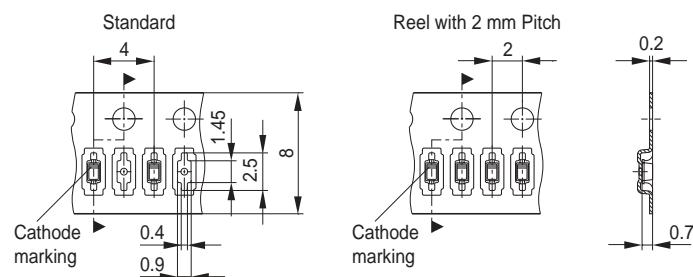



Date Code marking for discrete packages with one digit (SCD80, SC79, SC75<sup>1)</sup>) CES-Code

Month	2003	2004	2005	2006	2007	2008	2009	2010	2011	2012	2013	2014
01	a	p	A	P	a	p	A	P	a	p	A	P
02	b	q	B	Q	b	q	B	Q	b	q	B	Q
03	c	r	C	R	c	r	C	R	c	r	C	R
04	d	s	D	S	d	s	D	S	d	s	D	S
05	e	t	E	T	e	t	E	T	e	t	E	T
06	f	u	F	U	f	u	F	U	f	u	F	U
07	g	v	G	V	g	v	G	V	g	v	G	V
08	h	x	H	X	h	x	H	X	h	x	H	X
09	j	y	J	Y	j	y	J	Y	j	y	J	Y
10	k	z	K	Z	k	z	K	Z	k	z	K	Z
11	l	2	L	4	l	2	L	4	l	2	L	4
12	n	3	N	5	n	3	N	5	n	3	N	5

1) New Marking Layout for SC75, implemented at October 2005.

Package Outline

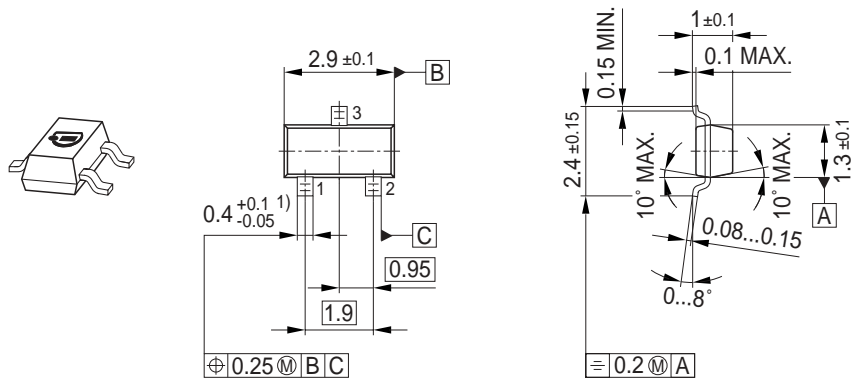

1) Lead width can be 0.6 max. in dambar area

Foot Print

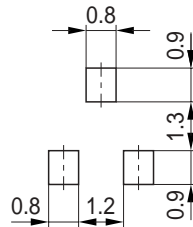

Marking Layout (Example)

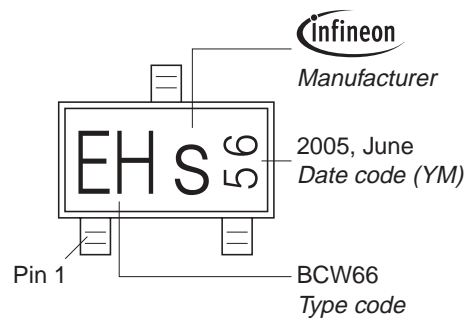

Standard Packing

Reel  $\varnothing$ 180 mm = 3.000 Pieces/Reel  
 Reel  $\varnothing$ 330 mm = 10.000 Pieces/Reel

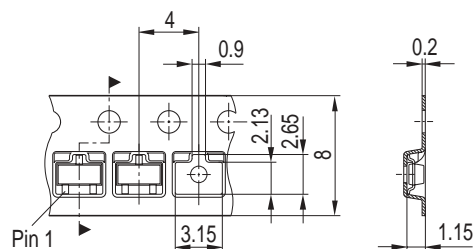

Package Outline

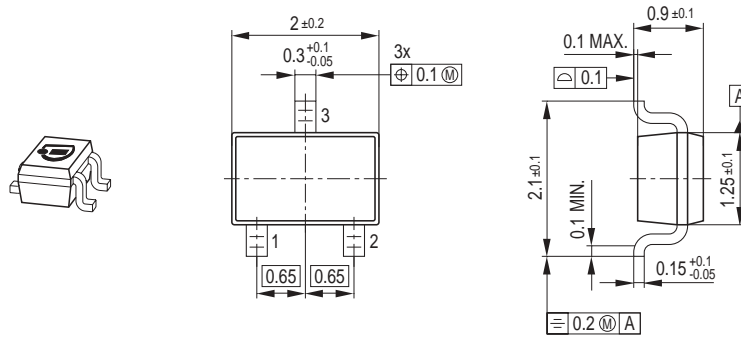

Foot Print

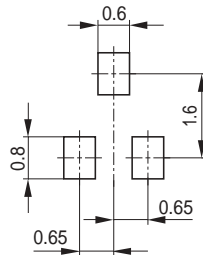

Marking Layout (Example)

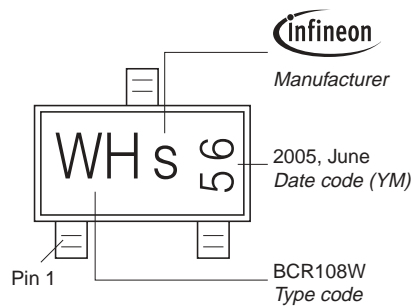

Standard Packing

Reel ø180 mm = 3.000 Pieces/Reel  
 Reel ø330 mm = 10.000 Pieces/Reel

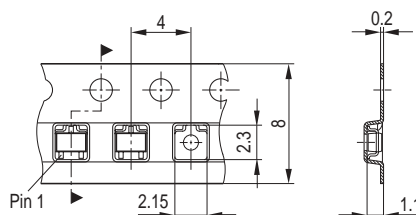

Edition 2006-02-01  
Published by  
Infineon Technologies AG  
81726 München, Germany  
© Infineon Technologies AG 2007.  
All Rights Reserved.

### **Attention please!**

The information given in this dokument shall in no event be regarded as a guarantee of conditions or characteristics ("Beschaffenheitsgarantie"). With respect to any examples or hints given herein, any typical values stated herein and/or any information regarding the application of the device, Infineon Technologies hereby disclaims any and all warranties and liabilities of any kind, including without limitation warranties of non-infringement of intellectual property rights of any third party.

### **Information**

For further information on technology, delivery terms and conditions and prices please contact your nearest Infineon Technologies Office ([www.infineon.com](http://www.infineon.com)).

### **Warnings**

Due to technical requirements components may contain dangerous substances. For information on the types in question please contact your nearest Infineon Technologies Office.

Infineon Technologies Components may only be used in life-support devices or systems with the express written approval of Infineon Technologies, if a failure of such components can reasonably be expected to cause the failure of that life-support device or system, or to affect the safety or effectiveness of that device or system.

Life support devices or systems are intended to be implanted in the human body, or to support and/or maintain and sustain and/or protect human life. If they fail, it is reasonable to assume that the health of the user or other persons may be endangered.